



*Changes for the Better*

Air-to-water Heat Pump Systems

Split type

for a greener tomorrow 

## Time to change to smart heating...

*Starting living a better life with ecodan*



Keep on evolving!

Auto Adaptation

**ecodan**

Renewable Heating Technology



for a greener tomorrow

Eco Changes is the Mitsubishi Electric Group's environmental statement, and expresses the Group's stance on environmental management. Through a wide range of businesses, we are helping contribute to the realization of a sustainable society.

**MITSUBISHI ELECTRIC CORPORATION**  
HEAD OFFICE : TOKYO BLDG., 2-7-3, MARUNOUCHI, CHIYODA-KU, TOKYO 100-8310, JAPAN



Revised publication, effective Feb. 2013.  
Superseding publication of L-179-1-C9105-A Dec. 2012.  
Specifications are subject to change without notice.

# Using ecodan can heat rooms and supply domestic hot water, realising greater comfort and energy saving.

## “ecodan” – Economic, eco conscious next generation heating system

Both energy-saving and safe for the environment, the Mitsubishi Electric ecodan incorporates a highly efficient heat pump system that utilises electricity to capture “the heat in the air”, a renewable energy resource.

Equipped with advanced inverter control, meticulous temperature control assures comfortable heating, and its space-saving “All-in-one” indoor unit is easy to install.

These energy-saving, high comfort and simple installation characteristics have drawn the ecodan heating system into the spotlight centre stage.

Excellent ecodan’s heating performance, even at low outdoor temperature!



### The secret behind our impressive heat pump efficiency is capturing the heat in the air.

Heat pump systems are now capturing attention. With this technology, atmospheric heat is harnessed; that is, it is collected from the air and used as a heat source to provide highly efficient heating. For example, a heat pump with a coefficient of performance (COP) of 4.0 uses 1kW of electrical energy input and 3kW of heat energy transferred from outside-air to the heat pump for an impressive final heat output of 4kW.

#### Air-to-water heat pump principle (when heating)

Refrigerant and heat circulation  
< Case of COP 4.0 >

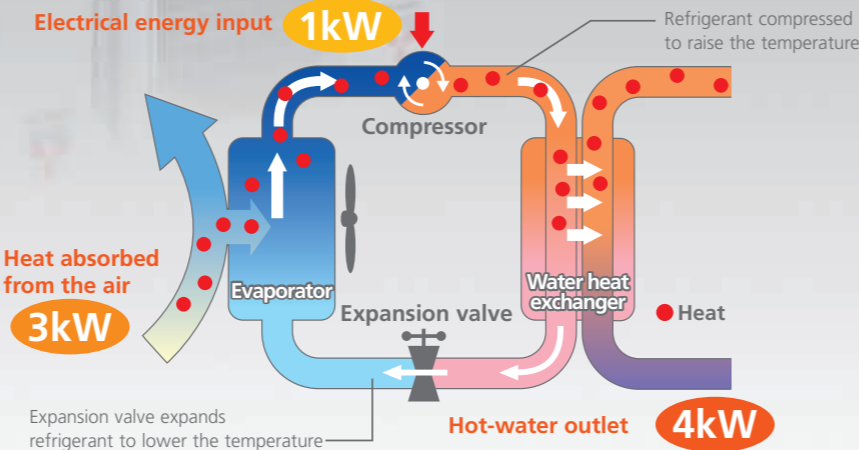

Produces 4 times the amount of energy input

1 kW Electrical energy input	+	3 kW Heat absorbed from the air	=	4 kW Heat outlet
---------------------------------	---	------------------------------------	---	---------------------

# Auto Adaptation



## ecodan – Maximize energy savings while keeping comfort at all times

Aiming to realise further comfort and energy savings, Mitsubishi Electric is proud to introduce a revolutionary new system control. This is based on data indicating that a 1°C drop in the flow temperature improves the coefficient of performance (COP) of the ATW system by 2%. This means that energy savings are dramatically affected by controlling the flow temperature in the system.

In conventional system control, the flow temperature is determined based on the preset heat curve depending on the actual outdoor temperature. However, this requires a complicated setting to achieve the optimal heat curve.

### Heat curve setting (Example)

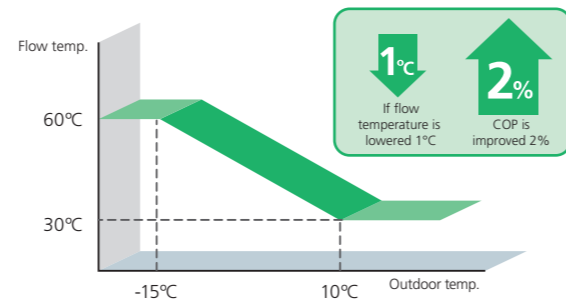

### Mitsubishi Electric's Auto Adaptation function automatically tracks changes of the actual room temperatures and outdoor temperatures and adjusts the flow temperature accordingly.

Our more evolutionary Auto Adaptation function measures the room temperature and outdoor temperature, and then calculates the required heating capacity for the room. Simply stated, the flow temperature is automatically controlled according to the required heating capacity, while optimal room temperature is maintained at all times, ensuring the appropriate heating capacity and preventing energy from being wasted. Furthermore, by estimating future changes in room temperature, the system works to prevent unnecessary increases and decreases in the flow temperature. Accordingly, Auto Adaptation maximises both comfort and energy savings without the need for complicated settings.

### Future room temperature estimation

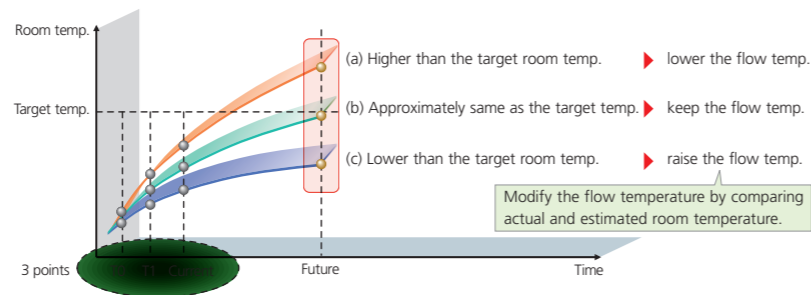

### Auto Adaptation – room temperature control

- 1) Installation site: South of Sweden
- 2) Detached house with underfloor heating
- 3) Data in February 2011



#### [Example]

#### a) Outdoor temperature is gradually decreasing...

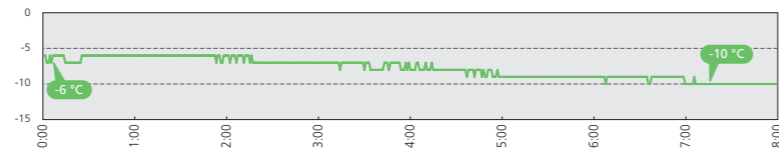

#### b) Target flow temperature

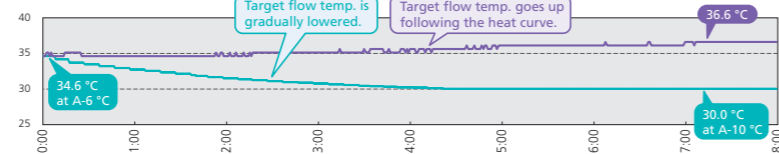

By Auto Adaptation, flow temperature can be lowered even when outdoor temp. is decreasing.

#### c) Room temperature

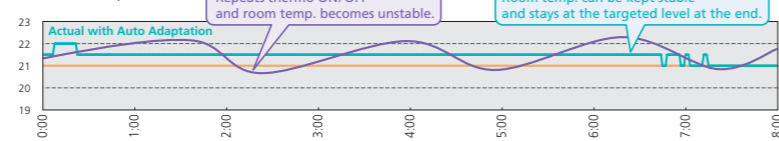

By Auto Adaptation, flow temperature can be lowered without sacrificing comfort.

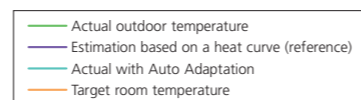

# Two zone control NEW

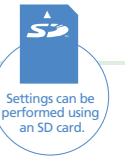

## Simultaneously making two different temperature zones assures more comfortable, highly convenient heating

ecodan makes it possible to set two temperatures which are used in two different types heat emitters in a system. The system allows adjustment of temperatures when different room temperatures are required, such as a temperature of 40°C for the living room radiator and temperature of 30°C for floor heating. Additionally, the scheduling for each zone can be set separately by main controller.

### Two temperature zones

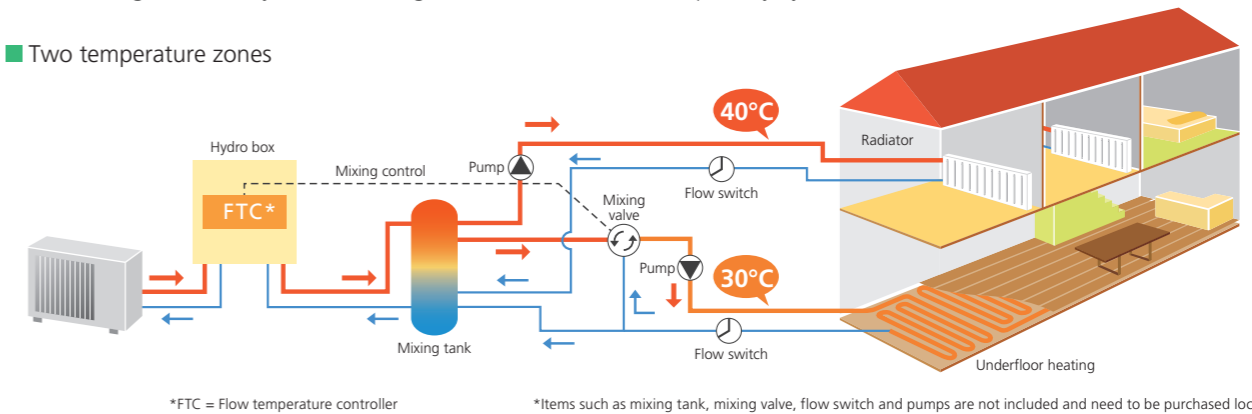

# Intelligent boiler interlock NEW



## No need to replace existing boiler! Automatic switchover enables even more efficient operation

The flexibility of ecodan's intelligent control allows the system to be combined with boiler currently in use. Additionally, this control can judge which heating source (ecodan, or boiler) to be operated according to situations. Customers using a boiler can receive the energy-saving performance of ecodan.

### Intelligent system combining a boiler with ecodan

#### Intelligent boiler interlock system

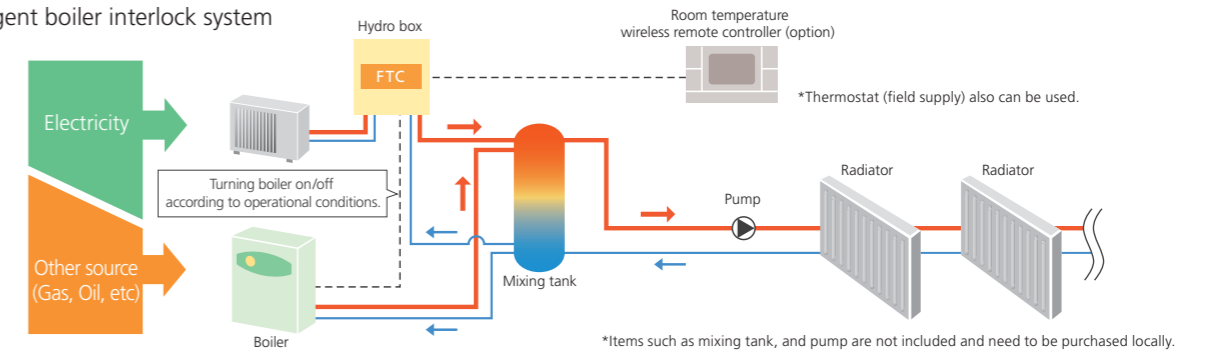

### Heat source switchover - Choose appropriate systems based on needs

#### 4 types of heat source switchover logic

- ① Switchover based on actual outdoor temperature
  - Heat source switchover occurs when the outdoor temperature drops to a preset temperature.
- ② Switchover based on running cost
  - Heat source switchover occurs by judging optimal operation based on running cost. \*Pre registration of energy price of electricity, and gas or oil per kWh are necessary.
- ③ Switchover based on CO<sub>2</sub> emission level
  - Heat source switchover occurs to minimize CO<sub>2</sub> emission. \*Pre registration of CO<sub>2</sub> emission amount from electricity, and gas or oil are necessary.
- ④ Switchover can also be activated via external input.
  - For example, peak cut signal from electric power company.

# Multiple unit control NEW



## Connect up to 6 units Automatic control of multiple units to supply bigger capacity

A maximum of 6 ecodan units\* can be configured according to the required heating load of the building. The most efficient number of operating units is determined automatically based on heating load. This enables ecodan to provide optimal room temperature control, and thus superior comfort for room occupants. Also incorporated is a rotation function that works to balance the running hours without depending on the operation of any one specific unit.

\*Only same models (same capacity) are available.

### Easily heating large, previously difficult to heat spaces ecodan provides amazing comfort and energy saving

Due to this multiple unit control, ecodan can be operated in large space. For example, even for areas requiring large heating load such as housing complexes, offices and shops the installation of multiple ecodan units managed by multiple unit control ensures optimally controlled heating and realises amazing comfort and energy saving.

#### Multiple unit control

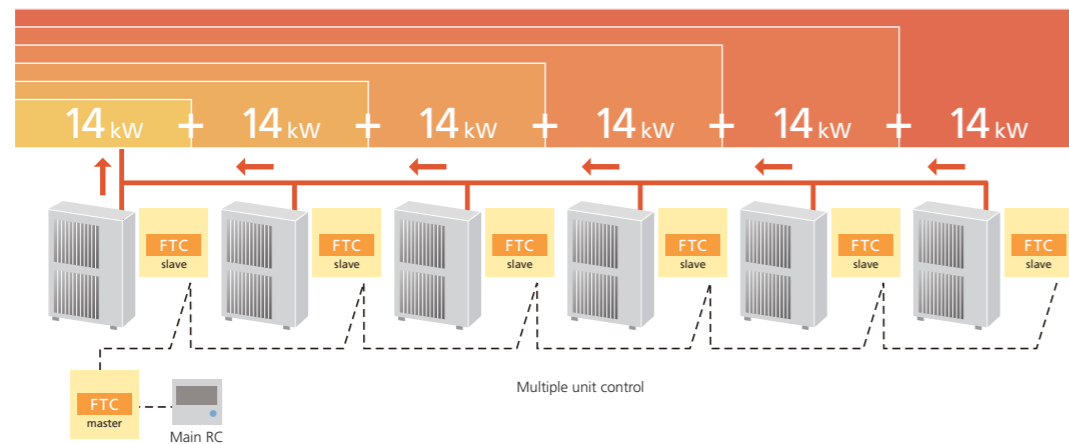
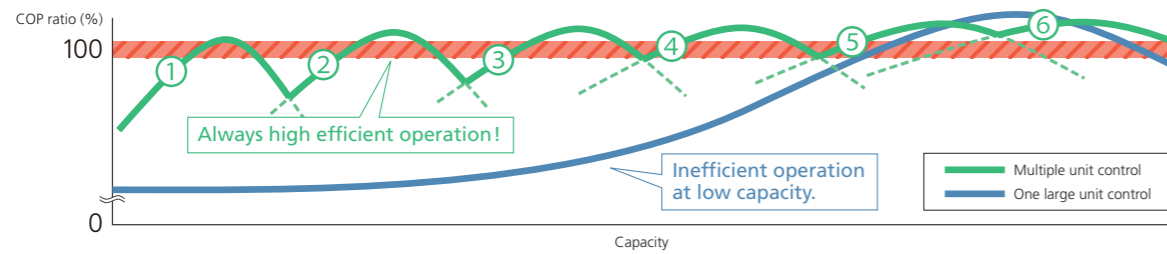

### Back-up operation at the time of malfunction

If one of the units malfunctions when using multiple unit control, another unit can be automatically operated for back-up, thereby preventing system operation from stopping completely.

#### Multiple unit control

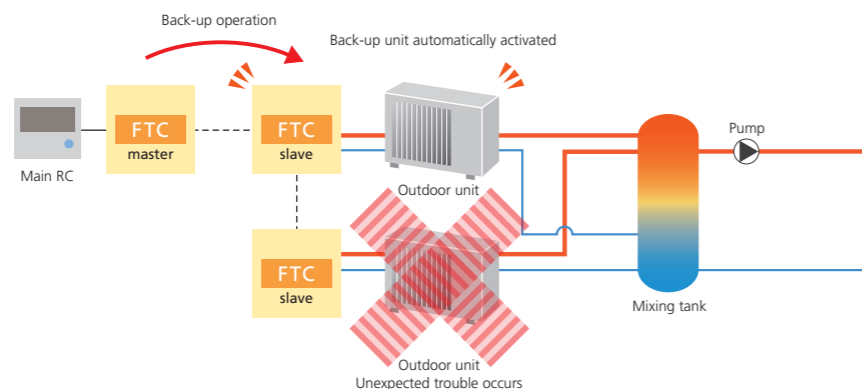

# SD\* CARD NEW

\*SD logo is a trademark of SD-3C, LLC

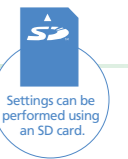

## The ecodan evolution continues! For easier settings and for data loggings

Initial setting for ecodan is now simpler than ever before. The special software enables the required initial settings to be saved to an SD card using a personal computer. System set-up is as easy as moving the SD card from the computer to the SD card slot in the indoor unit. Compared to the previous procedure of inputting settings using the main controller at a installation field, a remarkable reduction in set-up time has been achieved. Thus, it is ideal way for busy installers.

\*SD card function is only used by installer.

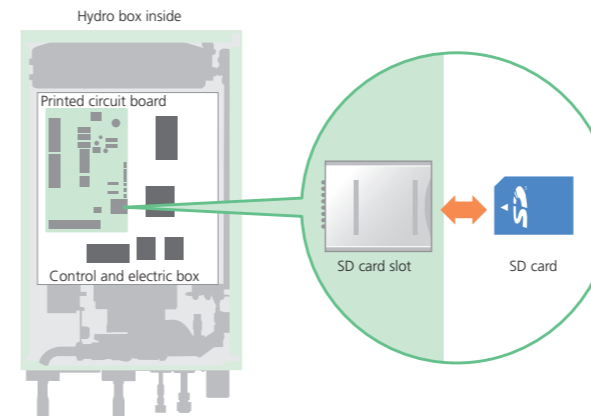

Settings can be performed easily and logging operation data in SD card can be confirmed via personal computer.

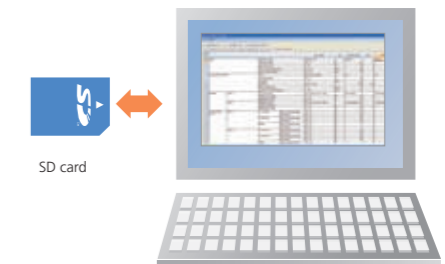

### Items that can be preset

Simply copying the preset data to SD card, same settings are complete in multiple units easily.

- Initial settings (time display, contact number, etc)
- Heating settings
  - Auto Adaptation
  - Heat curve
  - Two different temperatures zones
- Interlocked boiler operation settings
- Holiday mode settings
- Schedule timer settings
- Domestic hot water settings
- Legionella prevention settings

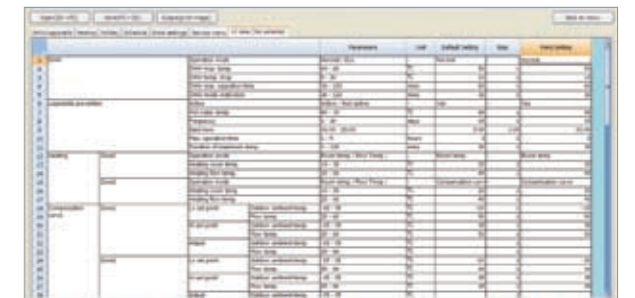

All items that are set by the main controller can be set via a personal computer.

### Data that can be stored

Operation data up to a month long can be stored on a SD card (2GB).

- Operation time
- Defrost time
- Actual temperature
  - Room
  - Flow temperature
  - Return temperature
  - Domestic hot water temperature
  - Outdoor temperature
- Error record
- Input signal

etc.

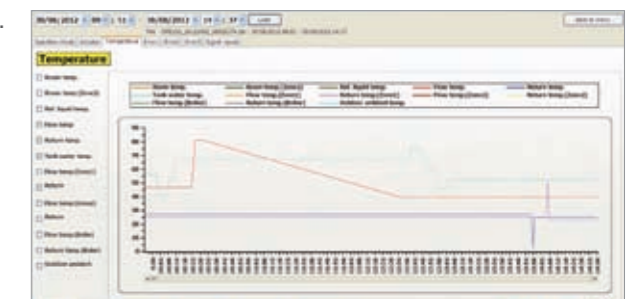

# Remote controller

## Stylish, easy-to-read bright LCD with ergonomically designed intuitive interface

### Main controller

- Large screen and backlight for excellent visibility, even in dark environment
- Multilanguage support (11 languages)
- Can be removed from main unit and installed in remote location (up to 500m)
- Wide range of convenient functions in response to user demand
  - Functions settings
    - NEW -Two zone control -Boiler interlock -Floor drying up
    - Weekly timer -Holiday mode -Legionella prevention -Error codes and data for serving
- Quick reading of operation data (7.5 times faster than previous model)



Main controller

### Wireless remote controller (optional)

- Built-in room temperature sensor; easy to place in the best position to detect room temperature
- Wiring work eliminated
- Simple design that is easy to operate
- Remote control from any room without needing to choose an installation location
- Backlight and big buttons that are easy to operate
- Domestic hot water boost and cancellation
- Simplified holiday mode



PAR-WR51R-E (Option) Receiver



PAR-WT50R-E (Option) Wireless remote controller

# All-in-one & compact

## Small overall size contributes to easy transportation, installation and maintenance

- Simplified: All key functional components are incorporated into the unit.
- Easy servicing: Relevant parts are located at the front of the unit to access easily.
- Easy to transport and install using the attached handle both at front and at back (cylinder unit) and also back plate (hydro box unit).
- Easy to open the packaging without using knife.

### Compact cylinder unit

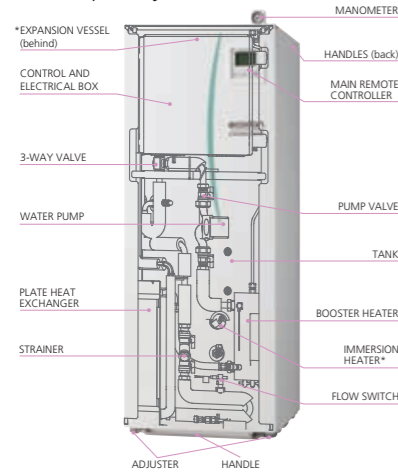

### Compact hydro box unit

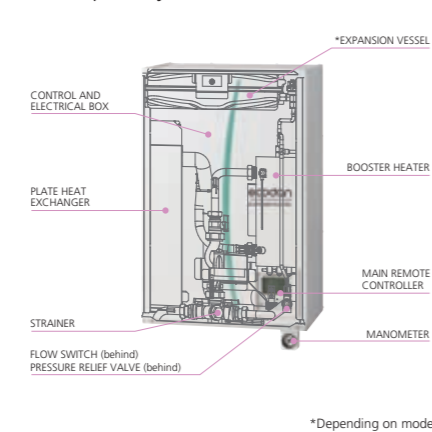

\*Depending on model



# Reversible models (hydro box for cooling / heating) NEW

## Not only heating, but comfortable cooling as well

- Automatic changeover function enables switchover for cooling and hot-water supply.
- A drain pan is provided as standard equipment.
- Use of G1 nut enables quick, easy piping connection.



# Designed for optimal heating NEW

## Newly designed outdoor units are now available.

Focusing mainly on use in heating, the following items have been newly improved.

- ① High flow temperature (supply at maximum 60°C achieved)
- ② Improved coefficient of performance (COP)
- ③ Stand-by power consumption is almost halved due to introduction AC power heating for compressor.

All units achieve 60°C flow temperature.



# ZUBADAN New Generation NEW

## Improved heating performance more efficiently



ZUBADAN is equipped with a unique "Flash Injection Circuit" that enables the system to provide powerful heating in cold regions during the winter months. And more evolved "ZUBADAN New Generation" incorporates a new compressor that is more efficient, further improving heating performance when outdoor temperatures is low. The rated heating capacity can now be maintained at -15°C even including defrost, making it possible to supply comfortable heating in ever more severe environments.

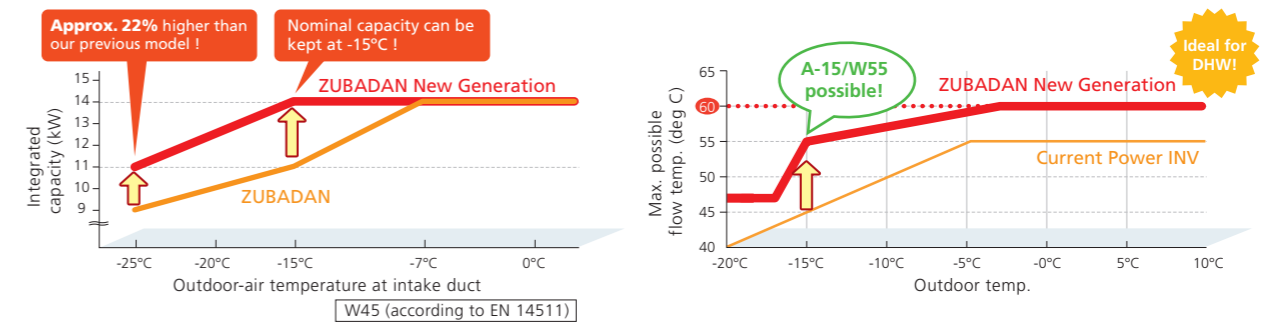

## Mitsubishi Electric Flash Injection Technology The key to high heating performance at low outdoor temperatures

### Flash Injection Circuit

#### ZUBADAN New Generation

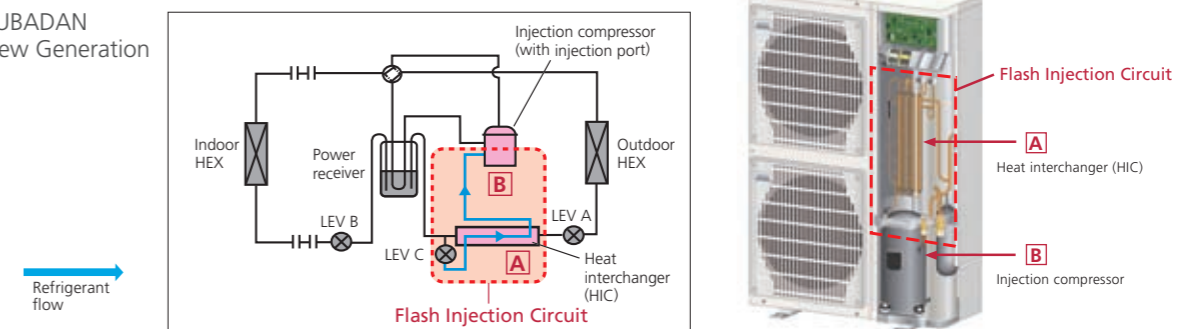

The Flash Injection Circuit is an original technology developed by Mitsubishi Electric. A heat exchange process at point (A) (heat interchanger) transforms liquid refrigerant into a two-phase, gas-liquid state and then compresses the gas-liquid refrigerant at point (B) (injection compressor). This circuit secures a enough flow rate of refrigerant for heating when outdoor temperatures are very low. In the ZUBADAN New Generation, the Flash Injection Circuit is more powerful by improving the heat interchanger to increase the heat-exchange-efficiency and incorporating new injection compressor to increase the compression-efficiency. These two improvements of ZUBADAN New Generation ensure reliable, efficient heating operation when outdoor temperatures are very low.

## Specifications (Split type)

### Indoor unit

Model name		Type		Heating only									
		Expansion vessel											
Dimensions		HxWxD	mm	1600x595x680									
Casing	RAL code	RAL 9016											
	Material	Pre-coated metal											
Product weight (empty)		kg	128	128	128	125	127	127	122	122	128		
Type of installation		Floor standing											
Power supply (V / Phase / Hz)		230/Single/50											
Heater	Booster heater	Power supply (V / Phase / Hz)	230/Single/50	400/Three/50	230/Three/50	230/Single/50	230/Single/50	400/Three/50	230/Single/50	400/Three/50	230/Single/50		
		Capacity	kW	6 (2/4/6)	9 (3/6/9)	9 (3/6/9)	2	6 (2/4/6)	9 (3/6/9)	6 (2/4/6)	9 (3/6/9)	6 (2/4/6)	
		Current	A	26	13	23	9	26	13	26	13	26	
		Breaker	A	32	16	30	16	32	16	32	16	32	
Heater	Immersion heater	Power supply (V / Phase / Hz)	230/Single/50	230/Single/50	230/Single/50	-	-	-	-	-	-		
		Capacity	kW	3	3	3	-	-	-	-	-		
		Current	A	13	13	13	-	-	-	-	-		
		Breaker	A	16	16	16	-	-	-	-	-		
Domestic hot water tank	Volume (net)	L	200										
	Material	Duplex stainless steel (EN10088)											
Operating ambient condition*		0~35											
Target temperature range	Heating	Room temperature	°C										
		Flow temperature	°C										
		DHW	°C										
		Legionella prevention	°C										
Sound level (SPL)		dB (A)	28										

\*The environment must be frost-free.

### <Hydro box>

Model name		Type		Heating only						Heating and Cooling	
		Expansion vessel									
Dimensions		HxWxD	mm	800x530x360						860x530x360	
Casing	RAL code	RAL 9016									
	Material	Pre-coated metal									
Product weight (empty)		kg	51	53	53	53	49	49	54		
Type of installation		Wall mounted									
Power supply (V / Phase / Hz)		230/Single/50									
Heater	Booster heater	Power supply (V / Phase / Hz)	230/Single/50	230/Single/50	400/Three/50	230/Three/50	230/Single/50	400/Three/50	230/Single/50		
		Capacity	kW	2	6 (2/4/6)	9 (3/6/9)	9 (3/6/9)	6 (2/4/6)	9 (3/6/9)	2	
		Current	A	9	26	13	23	26	13	9	
		Breaker	A	16	32	16	30	32	16	16	
Domestic hot water tank	Volume (net)	L	-								
	Material	-									
Operating ambient condition*1		°C									
Target temperature range	Heating	Room temperature	°C						N/A		
		Flow temperature	°C						°C		
		DHW	°C						°C		
		Legionella prevention	°C						°C		
Sound level (SPL)		dB(A)	28						28		

\*1 The environment must be frost-free.

\*2 Low outdoor temperature cooling is not allowed (minimum 10°C).

### Connectable outdoor unit

Model name		PUHZ-								
		SW40VHA (-BS)			SW50VHA (-BS)			SW75VHA (-BS)		
Dimensions		HxWxD	mm	600x800x300	600x800x300	943x950x330	1350x950x330	1350x950x330	1350x950x330	1350x950x330
Product weight		kg	42	42	75	118/130	118/130	120	120/134	134
Power supply (V / Phase / Hz)		VHA : 230/Single/50 YHA : 400/Three/50								
Heating (A7/W35)	Capacity	kW	4.10	6.00	8.00	11.20	16.00	8.00	11.20	14.00
	COP		4.80	4.42	4.40	4.45	4.10	4.65	4.46	4.22
	Power input	kW	0.854	1.357	1.819	2.517	3.903	1.721	2.512	3.318
Heating (A2/W35)	Capacity	kW	4.00	5.00	7.50	10.00	12.00	8.00	11.20	14.00
	COP		3.24	2.97	3.40	3.32	3.24	3.55	3.34	2.96
	Power input	kW	1.235	1.684	2.206	3.009	3.704	2.254	3.354	4.730
Sound level (SPL)	Heating	dB (A)	45	46	51	54	54	51	52	52
Sound level (PWL)	Heating	dB (A)	62	63	69	70	72	69	70	70

Note: based on EN 14511 (Not include input to circulation pump). It may differ according to the system configuration.

### Optional parts

Parts name	Model name	Specification	Cylinder unit										Hydro box																							
			EHST20C-VM6HB		EHST20C-YM9HB		EHST20C-TM9HB		EHST20C-VM2B		EHST20C-VM6B		EHST20C-YM9EB		EHST20C-VM6SB		EHSC-VM2B		EHSC-VM6B		EHSC-YM9B		EHSC-TM9B		EHSC-VM6EB		EHSC-YM9EB		EHSC-VM2B							
WIRELESS REMOTE CONTROLLER	PAR-WT50R-E		x	x	x	x	x	x	x	x	x	x	x	x	x	x	x	x	x	x	x	x	x	x	x	x	x	x	x	x	x	x	x	x	x	x
WIRELESS RECEIVER	PAR-WR51R-E		x	x	x	x	x	x	x	x	x	x	x	x	x	x	x	x	x	x	x	x	x	x	x	x	x	x	x	x	x	x	x	x	x	x
THERMISTOR	PAC-SE41TS-E	For room temp.	x	x	x	x	x	x	x	x	x	x	x	x	x	x	x	x	x	x	x	x	x	x	x	x	x	x	x	x	x	x	x	x	x	x
	PAC-TH011-E	For buffer and zone (flow and return temp.)	x	x	-	-	x	x	x	x	x	x	x	x	x	x	x	x	x	x	x	x	x	x	x	x	x	x	x	x	x	x	x	x	x	x
	PAC-TH011TK-E	For tank temp.	-	-	x	x	-	-	-	-	-	-	-	-	-	-	-	-	-	-	-	-	-	-	-	-	-	-	-	-	-	-	-	-	-	-
	PAC-TH-011HT-E	For boiler (flow and return temp.)	x	x	x	x	x	x	x	x	x	x	x	x	x	x	x	x	x	x	x	x	x	x	x	x	x	x	x	x	x	x	x	x	x	x
IMMERSION HEATER	PAC-IH03V-E	1Ph 3kW	-	-	-	-	x	x	x	x	x	x	x	x	x	x	x	x	x	x	x	x	x	x	x	x	x	x	x	x	x	x	x	x	x	x
JOINT PIPE	PAC-SH30R-E	For PUHZ-SW40/50VHA (-BS) φ9.52→φ6.35	x	x	x	x	x	x	x	x	x	x	x	x	x	x	x	x	x	x	x	x	x	x	x	x	x	x	x	x	x	x	x	x	x	x
	PAC-SH50R-E	For PUHZ-SW40/50VHA (-BS) φ15.88→φ12.70	x	x	x	x	x	x	x	x	x	x	x	x	x	x	x	x	x	x	x	x	x	x	x	x	x	x	x	x	x	x	x	x	x	x
DRAIN SOCKET	PAC-SH71DS-E	For outdoor unit	x	x	x	x	x	x	x	x	x	x	x	x	x	x	x	x	x	x	x	x	x	x	x	x	x	x	x	x	x	x	x	x	x	x
FLOW TEMPERATURE CONTROLLER (master)	PAC-IF051B-E		x	x	x	x	x	x	x	x	x	x	x	x	x	x	x	x	x	x	x	x	x	x	x	x	x	x	x	x	x	x	x	x	x	x
FLOW TEMPERATURE CONTROLLER (slave)	PAC-SIF051B-E		x	x	x	x	x	x	x	x	x	x	x	x	x	x	x	x	x	x	x	x	x	x	x	x	x	x	x	x	x	x	x	x	x	x

### Service access diagrams

#### Cylinder unit

Parameter	Dimension (mm)
a	300
b	150
c (distance behind unit)	10
d	500

Sufficient space MUST be left for the provision of discharge pipework as detailed in national local building regulations.

The cylinder unit must be located indoors and in a frost-free environment, for example in a utility room to minimize heat loss from stored water.

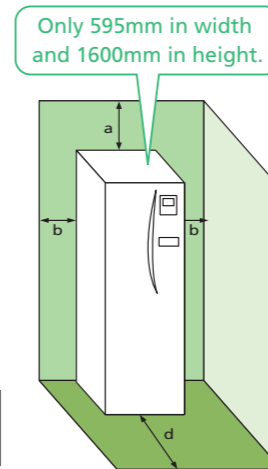

#### Hydro box

Parameter	Dimension (mm)
a	200
b	150
c	500
d	500

Sufficient space MUST be left for the provision of discharge pipework as detailed in national local building regulations.

The hydro box must be located indoors and in a frost-free environment, for example in a utility room.

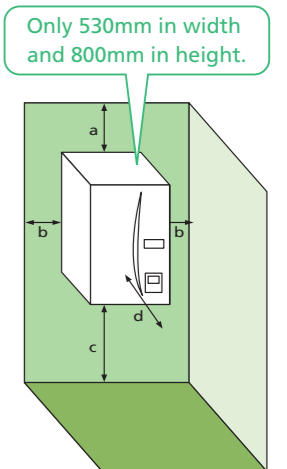

#### Hydro box (Reversible)

Parameter	Dimension (mm)
a	200
b	150
c	500
d	500

Sufficient space MUST be left for the provision of discharge pipework as detailed in national local building regulation.

The reversible hydro box must be located indoors and in a frost-free environment, for example in a utility room.

