



SiMT041311EA

R-32

Service Manual

Inverter Pair Wall Mounted Type FTXZ-N Series

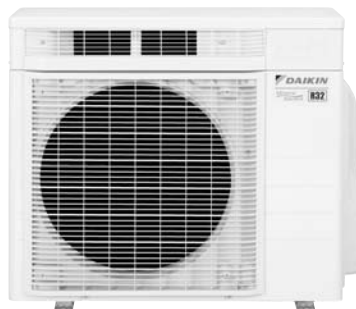

[Applied Models]

- Inverter Pair : Heat Pump

Inverter Pair Wall Mounted Type FTXZ-N Series

●Heat Pump

Indoor Unit

**FTXZ25NV1B
FTXZ35NV1B
FTXZ50NV1B**

Outdoor Unit

**RXZ25NV1B
RXZ35NV1B
RXZ50NV1B**

1. Safety Cautions.....	v
1.1 Warnings and Cautions Regarding Safety of Workers.....	v
1.2 Warnings and Cautions Regarding Safety of Users.....	xi
2. Icons Used.....	xiv
Part 1 List of Functions	1
1. Functions.....	2
Part 2 Specifications	3
1. Specifications.....	4
Part 3 Printed Circuit Board Connector Wiring Diagram	6
1. Indoor Unit.....	7
2. Outdoor Unit.....	10
Part 4 Functions and Control.....	12
1. Main Functions.....	13
1.1 Temperature Control.....	13
1.2 Frequency Principle.....	13
1.3 Airflow Direction Control.....	15
1.4 Fan Speed Control for Indoor Unit.....	19
1.5 Thermostat Control.....	20
1.6 URURU HUMIDIFY / HUMID HEATING Operation.....	21
1.7 SARARA DRY / DRY COOLING Operation.....	28
1.8 AUTO Operation.....	31
1.9 Sensor Operation.....	32
1.10 ECONO / OUTDOOR UNIT QUIET Operation.....	34
1.11 POWERFUL Operation.....	35
1.12 Air Purifying and Ventilation.....	36
1.13 MOLD PROOF Operation.....	39
1.14 CLEANING FILTER Operation.....	39
1.15 INFORMATION.....	41
1.16 Brightness Setting of Indoor Unit Lamps.....	41
1.17 TIMER Operation.....	42
1.18 COMFORT SLEEP TIMER Operation.....	43
1.19 QUICK HEATING TIMER Operation.....	43
1.20 Other Functions.....	44
2. Control Specification.....	45
2.1 Frequency Control.....	45
2.2 Controls at Mode Changing / Start-up.....	47
2.3 Discharge Pipe Temperature Control.....	49
2.4 Input Current Control.....	50
2.5 Freeze-up Protection Control.....	51
2.6 Heating Peak-cut Control.....	51
2.7 Draught Prevention Control (Hot-Start Function).....	52
2.8 Dew Prevention Control.....	53
2.9 Outdoor Fan Control.....	53
2.10 Defrost Control.....	54
2.11 Electronic Expansion Valve Control.....	55

Part 5 Installation / Operation Manual	58
1. Installation Manual	59
2. Operation Manual.....	78
Part 6 Service Diagnosis.....	122
1. Service Diagnosis	124
1.1 Indoor Unit.....	124
1.2 Outdoor Unit.....	124
1.3 Remote Controller	124
2. Troubleshooting	126
2.1 Error Codes and Description	126
2.2 Air conditioner does not run.	127
2.3 Air conditioner runs but does not cool (heat) the room.	129
2.4 When operation starts, safety breaker works.	130
2.5 Air conditioner makes big noise and vibration.	131
2.6 Air is not humidified enough.	132
2.7 FLASH STREAMER AIR PURIFYING operation does not run.	133
2.8 INTELLIGENT EYE operation does not run.	134
2.9 Indoor Unit PCB Abnormality	135
2.10 Freeze-up Protection Control / Heating Peak-cut Control	136
2.11 Fan Motor (DC Motor) or Related Abnormality.....	138
2.12 Thermistor or Related Abnormality (Indoor Unit).....	140
2.13 Humidity Sensor (for Humidifying) / Humidifying Thermistor Abnormality	141
2.14 Humidity Sensor (for Room) Abnormality.....	142
2.15 Outdoor Unit PCB Abnormality.....	143
2.16 OL Activation (Compressor Overload)	144
2.17 Compressor Lock	146
2.18 DC Fan Lock	147
2.19 Input Overcurrent Detection	148
2.20 Four Way Valve Abnormality	149
2.21 Discharge Pipe Temperature Control.....	151
2.22 High Pressure Control in Cooling	152
2.23 Compressor System Sensor Abnormality	153
2.24 Power Factor Correction Circuit Abnormality	154
2.25 Damper Abnormality.....	155
2.26 Position Sensor Abnormality	156
2.27 Thermistor or Related Abnormality (Outdoor Unit).....	158
2.28 Electrical Box Temperature Rise.....	160
2.29 Radiation Fin Temperature Rise	161
2.30 Output Overcurrent Detection	163
2.31 Humidifier Fan Motor System Abnormality / Fan Lock	165
2.32 Heater Wire Abnormality	166
2.33 Humidifying Thermistor Abnormality / Humidifying Heater Temperature Abnormality	167
2.34 Refrigerant Shortage.....	169
2.35 Low-voltage Detection or Over-voltage Detection.....	171
2.36 Signal Transmission Error (Between Indoor Unit and Outdoor Unit)....	173
2.37 Outdoor Unit PCB Abnormality or Communication Circuit Abnormality	175
2.38 Signal Transmission Error on Microcomputer for Humidifying	178

2.39 Unspecified Voltage (Between Indoor Unit and Outdoor Unit)	179
2.40 Improper Power Supply Wiring.....	180
2.41 Incomplete Setting for Hose Length	181
2.42 Lights-out of Microcomputer Status Lamp.....	182
3. Check	183
3.1 Thermistor Resistance Check	183
3.2 Fan Motor Connector Output Check	184
3.3 Humidity Sensor Check.....	184
3.4 Power Supply Waveforms Check.....	185
3.5 Electronic Expansion Valve Check.....	185
3.6 Four Way Valve Performance Check	186
3.7 Inverter Unit Refrigerant System Check.....	186
3.8 Inverter Analyser Check	187
3.9 Rotating Pulse Check on Outdoor Unit PCB	189
3.10 Installation Condition Check.....	190
3.11 Discharge Pressure Check.....	190
3.12 Outdoor Fan System Check	191
3.13 Main Circuit Short Check.....	191
3.14 Power Module Check	192

Part 7 Tips for Servicing 193



1. Tips for Servicing	194
1.1 Pump Down Operation	194
1.2 Forced Cooling Operation	194
2. Trial Operation	195
3. Field Settings	196
3.1 SET UP Menu	196
3.2 Service Setting Menu	196
3.3 Humidifying Hose Length Setting	199
4. Silicone Grease on Power Transistor / Diode Bridge.....	200

Part 8 Appendix..... 201

1. Piping Diagrams.....	202
1.1 Indoor Unit.....	202
1.2 Outdoor Unit.....	202
2. Wiring Diagrams.....	203
2.1 Indoor Unit.....	203
2.2 Outdoor Unit.....	204
3. Operation Limit.....	205

1. Safety Cautions



Be sure to read the following safety cautions before conducting repair work. After the repair work is complete, be sure to conduct a test operation to ensure that the equipment operates normally, and explain the cautions for operating the product to the customer.

	This manual is for the person in charge of maintenance and inspection.		This appliance is filled with R-32.
---	--	---	-------------------------------------







Caution Items







The caution items are classified into **Warning** and **Caution**. The **Warning** items are especially important since death or serious injury can result if they are not followed closely. The **Caution** items can also lead to serious accidents under some conditions if they are not followed. Therefore, be sure to observe all the safety caution items described below.







Pictograms



-  This symbol indicates an item for which caution must be exercised. The pictogram shows the item to which attention must be paid.
-  This symbol indicates a prohibited action. The prohibited item or action is shown in the illustration or near the symbol.
-  This symbol indicates an action that must be taken, or an instruction. The instruction is shown in the illustration or near the symbol.

1.1 Warnings and Cautions Regarding Safety of Workers

 Warning	
Do not store equipment in a room with fire sources (e.g., naked flames, gas appliances, electric heaters).	
Be sure to disconnect the power cable from the socket before disassembling equipment for repair. Working on equipment that is connected to the power supply may cause an electrical shock. If it is necessary to supply power to the equipment to conduct the repair or inspect the circuits, do not touch any electrically charged sections of the equipment.	
If refrigerant gas is discharged during repair work, do not touch the discharged refrigerant gas. Refrigerant gas may cause frostbite.	
When disconnecting the suction or discharge pipe of the compressor at the welded section, evacuate the refrigerant gas completely at a well-ventilated place first. If there is gas remaining inside the compressor, the refrigerant gas or refrigerating machine oil discharges when the pipe is disconnected, and it may cause injury.	
If refrigerant gas leaks during repair work, ventilate the area. Refrigerant gas may generate toxic gases when it contacts flames.	

 Warning	
<p>Be sure to discharge the capacitor completely before conducting repair work. The step-up capacitor supplies high-voltage electricity to the electrical components of the outdoor unit. A charged capacitor may cause an electrical shock.</p>	
<p>Do not turn the air conditioner on or off by plugging in or unplugging the power cable. Plugging in or unplugging the power cable to operate the equipment may cause an electrical shock or fire.</p>	
<p>Be sure to wear a safety helmet, gloves, and a safety belt when working in a high place (more than 2 m). Insufficient safety measures may cause a fall.</p>	
<p>In case of R-32 / R-410A refrigerant models, be sure to use pipes, flare nuts and tools intended for the exclusive use with the R-32 / R-410A refrigerant. The use of materials for R-22 refrigerant models may cause a serious accident, such as a damage of refrigerant cycle or equipment failure.</p>	
<p>Do not mix air or gas other than the specified refrigerant (R-32 / R-410A / R-22) in the refrigerant system. If air enters the refrigerant system, an excessively high pressure results, causing equipment damage and injury.</p>	

 Caution	
<p>Do not repair electrical components with wet hands. Working on the equipment with wet hands may cause an electrical shock.</p>	
<p>Do not clean the air conditioner with water. Washing the unit with water may cause an electrical shock.</p>	
<p>Be sure to provide an earth / grounding when repairing the equipment in a humid or wet place, to avoid electrical shocks.</p>	
<p>Be sure to turn off the power switch and unplug the power cable when cleaning the equipment. The internal fan rotates at a high speed, and may cause injury.</p>	
<p>Be sure to conduct repair work with appropriate tools. The use of inappropriate tools may cause injury.</p>	

 Caution	
<p>Be sure to check that the refrigerating cycle section has cooled down enough before conducting repair work. Working on the unit when the refrigerating cycle section is hot may cause burns.</p>	
<p>Conduct welding work in a well-ventilated place. Using a welder in an enclosed room may cause oxygen deficiency.</p>	

■ **Checking the area**

Before beginning work, conduct safety checks to minimise the risk of ignition. When repairing the refrigerating system, take the following precautions before work.

■ **Work procedure**

Work shall be conducted under a controlled procedure so as to minimise the risk of working in the presence of R-32 or vapour.

■ **General working area**

All maintenance staff and others working in the local area shall be instructed on the nature of work being carried out.

Work in confined spaces shall be avoided.

The area around the workspace shall be sectioned off. Ensure that the conditions within the area have been made safe by control of flammable materials.

■ **Checking for presence of refrigerant**

The working area shall be checked with an appropriate refrigerant detector before and during work, to ensure the technician is aware of potentially flammable atmospheres.

Ensure that the leak detection equipment being used is suitable for use with R-32, i.e. non-sparking, adequately sealed or intrinsically safe.

■ **Fire extinguishing equipment**

If any hot work is to be conducted on the refrigeration equipment or any associated parts, appropriate fire extinguishing equipment shall be made available at hand. Prepare a dry powder or CO₂ fire extinguisher adjacent to the working area.

■ **No ignition sources**

During work on a refrigeration system which involves exposing any piping work that contains or has contained R-32, any sources of ignition shall not be used in a manner that may lead to the risk of fire or explosion. All possible ignition sources, including cigarette smoking, should be kept at a safe distance from the site of installation, repairing, or removing space. Before starting work, the area around the equipment shall be examined to make sure that there are no flammable hazard or ignition risks. No Smoking signs shall be displayed.

■ **Ventilated area**

Ensure that the working area is open or that it is adequately ventilated before work.

Adequate ventilation shall be maintained during the entire period of work.

The ventilation should disperse any released refrigerant and preferably discharge it into the external atmosphere.

■ Checking the refrigeration equipment

Where electrical components are to be changed, the new components shall be fit for the purpose and have the correct specifications.

The manufacturer's maintenance and service guidelines shall be followed at all times.

If there are any unclear points, consult the manufacturer's technical department for assistance.

The following checks shall be applied to any installation work involving R-32:

- The amount of charge is in accordance with the size of the room where the refrigerant containing parts are installed;
- The ventilation machinery and outlets are operating adequately and are not obstructed;
- If an indirect refrigerating circuit is being used, the secondary circuit shall be checked for the presence of refrigerant;
- Marking on the equipment is visible and legible. Markings and signs that are illegible shall be corrected;
- Refrigeration pipes or components are installed in a position where they are unlikely to be exposed to any substance which may corrode refrigerant containing components, or the refrigerant containing components are constructed of materials which are inherently resistant to corrosion or are suitably protected against corrosion.

■ Checking electrical devices

Repair and maintenance to electrical components shall include initial safety checks and component inspection procedures. In case there is any fault that could endanger safety, no electrical supply shall be connected to the circuit until the fault is satisfactorily dealt with.

Initial safety checks shall include:

- that capacitors are discharged: this shall be done in a safe manner to avoid possibility of sparking;
- that no live electrical components and wiring are exposed while charging, recovering or purging the system;
- that the equipment is earthed at all times.

■ Repairs to sealed components

During repairs to sealed components, all electrical supplies shall be disconnected from the equipment being worked upon before the removal of any sealed covers, etc. If it is absolutely necessary to have power supplied to equipment during servicing, continuously operating leak detection shall be installed at the most dangerous point of the system in order to warn of a potentially hazardous situation.

Particular attention shall be paid to the following: ensure that working on electrical components does not alter the casing in such a way that affects the level of protection including damage to cables, excessive number of connections, terminals different from the original specification, damage to seals, incorrect fitting of glands, etc.

Ensure that the equipment is mounted securely.

Ensure that seals or sealing materials have not degraded such that they no longer serve the purpose of preventing the ingress of flammable atmospheres. Replacement parts shall be in accordance with the manufacturer's specifications.

The use of silicon sealant may inhibit the effectiveness of some types of leak detection equipment. Intrinsically safe components do not have to be isolated before working on them.

■ Repair to intrinsically safe components

Do not apply any permanent inductive or capacitance load to the circuit without ensuring that this will not exceed the permissible voltage and current for the equipment in use.

Only intrinsically safe components can be worked on in the presence of a flammable atmosphere.

The test apparatus shall be of correct rating.

Replace components only with parts specified by the manufacturer. Using other parts may result in ignition of the refrigerant leaked into the atmosphere.

■ Wiring

Check that wiring is not subject to wear, corrosion, excessive pressure, vibration, sharp edges or any other adverse environmental effects. The check shall also take into account the effects of ageing or continuous vibration from sources such as compressors or fans.

■ Detecting of R-32

Under no circumstances shall potential sources of ignition be used in the search for or detection of refrigerant leaks. A halide torch (or any other detector using a naked flame) shall not be used.

■ Leak detection methods

The following leak detection methods can be applied for systems containing R-32.

Electronic leak detectors shall be used to detect R-32, but the sensitivity may not be adequate or may need re-calibration (detection equipment shall be calibrated in a refrigerant-free area). Ensure that the detector is not a potential source of ignition and that it is suitable for the refrigerant used. Leak detection equipment shall be set to the percentage of the lower flammability limit (LFL) of the refrigerant and calibrated to fit the refrigerant employed. The appropriate percentage of gas (maximum 25%) shall be confirmed.

Leak detection fluids are suitable for use with most refrigerants but the use of detergents containing chlorine shall be avoided as the chlorine may react with the refrigerant and corrode the copper piping work.

If a leak is suspected, all naked flames shall be removed or extinguished.

If a refrigerant leakage which requires brazing is found, all of the refrigerant shall be recovered from the system, or isolated (by means of shut off valves) in a part of the system remote from the point of the leakage. Oxygen free nitrogen (OFN) shall then be purged through the system both before and during the brazing process.

■ Removal and evacuation

When breaking the refrigerant circuit to make repairs or any other purpose, conventional procedures may be used. However, flammability must be taken into consideration. The following procedure shall be adhered to:

- Remove refrigerant;
- Purge the circuit with inert gas;
- Evacuate the inert gas;
- Purge again with inert gas;
- Carry out cutting or brazing of the circuit.

The refrigerant shall be recovered into the correct recovery cylinders. The system shall be cleaned with OFN to render the unit safe. (= Flushing) This process may need to be repeated several times. Compressed air or oxygen shall not be used for this task.

Flushing shall be achieved through breaking the vacuum by filling the system with OFN until the working pressure is achieved, then venting the OFN into the atmosphere, and finally pulling the system down to vacuum again. This process shall be repeated until no refrigerant remains within the system. After the last OFN charge is finished, the system shall be vented down to atmospheric pressure to enable work. This operation is especially important if brazing operations on the piping work are to take place.

Ensure that the outlet for the vacuum pump is not close to any ignition sources and that there is ventilation available.

■ Charging procedures

In addition to conventional charging procedures, the following requirements shall be met.

Ensure that the charging equipment to be used is not contaminated by different refrigerants. Hoses or lines shall be as short as possible to minimise the amount of refrigerant contained in them.

- Cylinders shall be kept upright.
- Ensure that the refrigeration system is earthed before charging the system with refrigerant.
- Label the system when charging is complete (if not already).
- Extreme care shall be taken not to overfill the refrigeration system.

Before recharging, the system shall be tested for leakage with OFN. On completion of charging, the system shall be tested before commissioning. Follow up leakage test shall be carried out before leaving the site.

■ Decommissioning

Before carrying out this procedure, it is essential that the technician is completely familiar with the equipment and all its details. It is recommended to train technicians so that all of the refrigerant is recovered safely. In case analysis is required before re-using the reclaimed refrigerant, an oil and refrigerant sample shall be taken before proceeding with decommissioning. It is essential that electrical power is available before work.

- a) Comprehend the equipment and its operation.
- b) Isolate the system electrically.
- c) Before starting work, ensure that:
 - mechanical handling equipment is available if required, for handling refrigerant cylinders;
 - protective equipment can be used in compliance with specifications;
 - the recovery process is supervised by a competent person at all times;
 - recovery equipment and cylinders conform to the appropriate standards.
- d) Pump down the refrigerant system, if possible.
- e) If vacuum can not be ensured, apply a manifold so that refrigerant can be removed from various parts of the system.
- f) Make sure that the cylinder is situated on the scale before recovery takes place.
- g) Start the refrigerant recovery device and operate it in accordance with the manufacturer's instructions.
- h) Do not overfill cylinders. (Do not exceed 80% liquid charge volume).
- i) Do not exceed the maximum working pressure of the cylinder, even temporarily.
- j) When the cylinders have been filled correctly and the process is completed, make sure that the cylinders and the equipment are removed from site promptly and all valves on the equipment are closed.
- k) Recovered refrigerant shall not be charged into another refrigeration system before it has been cleaned and checked.

■ Labelling

Equipment shall be labelled stating that it has been decommissioned and emptied of refrigerant. The label shall be dated and signed. Ensure that there are labels on the equipment stating the equipment contains R-32.

■ Refrigerant recovery

When removing refrigerant from a system, either for servicing or decommissioning, it is recommended to conduct training so that all refrigerants can be removed safely.











When transferring refrigerant into cylinders, ensure that only appropriate refrigerant recovery cylinders are used.





Ensure that the correct number of cylinders for holding the total system charge are available. All cylinders to be used must be designated for the recovered refrigerant and labelled for that refrigerant (i.e. special cylinders for the recovery of refrigerant). Cylinders shall be equipped with a pressure relief valve and associated shut-off valves in good working order. If possible, empty recovery cylinders shall be cooled in a separate place before recovery is conducted. The recovery equipment shall be in good working order with instructions concerning the equipment at hand, and shall be suitable for the recovery of R-32. In addition, a set of calibrated weighing scales shall be available and in good working order. Hoses shall be equipped with leak-free disconnect couplings and in good condition. Before using the recovery device, check that it has undergone proper maintenance, that it is in satisfactory working order, and that any associated electrical components are sealed to prevent ignition in the event of a refrigerant leakage. Consult manufacturer if in doubt.







The recovered refrigerant shall be returned to the refrigerant supplier in the correct recovery cylinder, with the relevant Waste Transfer Note attached. Do not mix refrigerants in recovery units and especially not in cylinders.



If compressors or compressor oil are to be removed, ensure that the refrigerant melted into the oil has been evacuated to an acceptable level to make certain that R-32 does not remain within the oil. The evacuation process shall be carried out before returning the compressor to the supplier. Only electric heating to the compressor body shall be employed to accelerate this process. Oil drained from the system shall be treated safely.

1.2 Warnings and Cautions Regarding Safety of Users

 Warning	
<p>Do not store the equipment in a room with fire sources (e.g., naked flames, gas appliances, electric heaters).</p>	
<p>Be sure to use parts listed in the service parts list of the applicable model and appropriate tools to conduct repair work. Never attempt to modify the equipment. The use of inappropriate parts or tools may cause an electrical shock, excessive heat generation or fire.</p>	
<p>If the power cable and lead wires are scratched or have deteriorated, be sure to replace them. Damaged cable and wires may cause an electrical shock, excessive heat generation or fire.</p>	
<p>Do not use a joined power cable or extension cable, or share the same power outlet with other electrical appliances, since it may cause an electrical shock, excessive heat generation or fire.</p>	
<p>Be sure to use an exclusive power circuit for the equipment, and follow the local technical standards related to the electrical equipment, the internal wiring regulations, and the instruction manual for installation when conducting electrical work. Insufficient power circuit capacity and improper electrical work may cause an electrical shock or fire.</p>	
<p>Be sure to use the specified cable for wiring between the indoor and outdoor units. Make the connections securely and route the cable properly so that there is no force pulling the cable at the connection terminals. Improper connections may cause excessive heat generation or fire.</p>	
<p>When wiring between the indoor and outdoor units, make sure that the terminal cover does not lift off or dismount because of the cable. If the cover is not mounted properly, the terminal connection section may cause an electrical shock, excessive heat generation or fire.</p>	
<p>Do not damage or modify the power cable. Damaged or modified power cables may cause an electrical shock or fire. Placing heavy items on the power cable, or heating or pulling the power cable may damage it.</p>	
<p>Do not mix air or gas other than the specified refrigerant (R-32 / R-410A / R-22) in the refrigerant system. If air enters the refrigerant system, an excessively high pressure results, causing equipment damage and injury.</p>	
<p>If the refrigerant gas leaks, be sure to locate the leaking point and repair it before charging the refrigerant. After charging the refrigerant, make sure that there is no leak. If the leaking point cannot be located and the repair work must be stopped, be sure to pump-down, and close the service valve, to prevent refrigerant gas from leaking into the room. Refrigerant gas itself is harmless, but it may generate toxic gases when it contacts flames, such as those from fan type and other heaters, stoves and ranges.</p>	





 Warning	
<p>When relocating the equipment, make sure that the new installation site has sufficient strength to withstand the weight of the equipment. If the installation site does not have sufficient strength or the installation work is not conducted securely, the equipment may fall and cause injury.</p>	
<p>Check to make sure that the power cable plug is not dirty or loose, then insert the plug into a power outlet securely. If the plug is dusty or has a loose connection, it may cause an electrical shock or fire.</p>	
<p>When replacing the coin battery in the remote controller, be sure to dispose of the old battery to prevent children from swallowing it. If a child swallows the coin battery, see a doctor immediately.</p>	

 Caution	
<p>Installation of a leakage breaker is necessary in some cases depending on the conditions of the installation site, to prevent electrical shocks.</p>	
<p>Do not install the equipment in a place where there is a possibility of combustible gas leaks. If combustible gas leaks and remains around the unit, it may cause a fire.</p>	
<p>Check to see if parts and wires are mounted and connected properly, and if connections at the soldered or crimped terminals are secure. Improper installation and connections may cause excessive heat generation, fire or an electrical shock.</p>	
<p>If the installation platform or frame has corroded, replace it. A corroded installation platform or frame may cause the unit to fall, resulting in injury.</p>	
<p>Check the earth / grounding, and repair it if the equipment is not properly earthed / grounded. Improper earth / grounding may cause an electrical shock.</p>	
<p>Be sure to measure insulation resistance after the repair, and make sure that the resistance is 1 MΩ or higher. Faulty insulation may cause an electrical shock.</p>	

 Caution	
<p>Be sure to check the drainage of the indoor unit after the repair. Faulty drainage may cause water to enter the room and wet the furniture and floor.</p>	
<p>Do not tilt the unit when removing it. The water inside the unit may spill and wet the furniture and floor.</p>	

2. Icons Used

The following icons are used to attract the attention of the reader to specific information.

Icon	Type of Information	Description
 Warning	Warning	A Warning is used when there is danger of personal injury.
 Caution	Caution	A Caution is used when there is danger that the reader, through incorrect manipulation, may damage equipment, lose data, get an unexpected result or have to restart (part of) a procedure.
 Note:	Note	A Note provides information that is not indispensable, but may nevertheless be valuable to the reader, such as tips and tricks.
	Reference	A Reference guides the reader to other places in this binder or in this manual, where he/she will find additional information on a specific topic.

Part 1

List of Functions

1. Functions.....2

1. Functions

Category	Functions	New model (FTXZ-N)	Old model (FTXR-E)	Category	Functions	New model (FTXZ-N)	Old model (FTXR-E)
Basic Function	PAM control	●	●	Health and Cleanliness	Titanium apatite deodorising filter	—	●
	Swing compressor	●	●		Air-purifying and deodorising filter	●	—
	Reluctance DC motor	●	●		Air filter (pre-filter)	●	●
	Standby electricity saving	●	—		Air supply filter	●	●
Operation	URURU HUMIDIFY operation	●	●		MOISTURISING operation	●	●
	SARARA DRY operation	●	●		FLASH STREAMER AIR PURIFYING operation	●	●
	DRY COOLING operation	●	●		FRESH AIR SUPPLY VENTILATION operation	●	●
	Programme dry operation	—	—		HOME LEAVE VENTILATION operation	—	●
	AUTO operation	●	●		MOULD PROOF operation	●	●
Comfortable Airflow	Power-airflow flaps	●	●		MOULD SHOCK OUT operation	—	●
	Wide-angle louvres	●	●		CLEANING FILTER operation	●	—
	Auto-swing (up and down)	●	●		Filter cleaning indicator (remote controller)	—	●
	Auto-swing (right and left)	●	●		Mould proof stick	—	●
	3-D airflow	●	●		Hydrophilic coated indoor heat exchanger	●	—
	3-area INTELLIGENT EYE operation	●	—		Mould proof indoor heat exchanger	●	—
	COMFORT AIRFLOW operation	—	●		Washable upper grille	—	●
	Comfort airflow with INTELLIGENT EYE sensor	●	—		Wipe-clean flat panel	●	●
	Circulation airflow	●	—		Hot-start function	●	●
	COOLING BREEZE operation	—	●		Quick warming function (preheating operation)	—	●
BREEZE airflow	●	—	Automatic defrosting	●	●		
Living Convenience	Auto fan speed	●	●	Comfortable Temperature	Installation position setting	●	—
	Indoor unit quiet operation	●	●		Multi-split / split type compatible indoor unit	—	—
	FAN ONLY operation	●	—		Either side drain (right or left)	●	●
	Inverter POWERFUL operation	●	●		Anti-corrosion treatment of outdoor heat exchanger	●	●
	ECONO operation	●	—	Installation and Service	Low temperature cooling operation (–15°C)	—	—
	OUTDOOR UNIT QUIET operation	●	—		Self-diagnosis display (remote controller)	●	●
	AUTO OFF operation	●	—		Home automation correspondence	●	●
	INFORMATION display	●	●				
	CHILDPROOF LOCK	●	●				
	R/C with back light	●	—				
	Remote controller setting memory	●	—				
	Indoor unit lamp brightness setting	●	●				
	Multi-coloured indicator lamp	—	●				
	Indoor unit ON/OFF button	●	●				
Auto-restart (after power failure)	●	●					
Timer	24-hour ON/OFF TIMER operation	●	●				
	DAILY ON/OFF TIMER operation	●	—				
	WEEKLY TIMER operation	—	—				
	COUNTDOWN OFF TIMER operation	●	●				
	NIGHT SET mode	—	●				
	COMFORT SLEEP TIMER operation	●	●				
	QUICK HEATING TIMER operation	●	—				

Note: ● : Available
— : Not available

Part 2 Specifications

1. Specifications4

1. Specifications

50 Hz, 220 - 230 - 240 V

Model	Indoor Unit		FTXZ25NV1B		FTXZ35NV1B	
	Outdoor Unit		RXZ25NV1B		RXZ35NV1B	
			Cooling	Heating	Cooling	Heating
Capacity Rated (Min. ~ Max.)	kW		2.5 (0.6 ~ 3.9)	3.6 (0.6 ~ 7.5)	3.5 (0.6 ~ 5.3)	5.0 (0.6 ~ 9.0)
	Btu/h		8,500 (2,000 ~ 13,100)	9,600 (2,000 ~ 25,500)	11,900 (2,000 ~ 18,100)	17,100 (2,000 ~ 30,700)
	kcal/h		2,150 (520 ~ 3,350)	2,150 (520 ~ 6,450)	3,010 (520 ~ 4,560)	2,150 (520 ~ 7,740)
Running Current (Rated)	A		2.0 - 1.9 - 1.9	2.9 - 2.8 - 2.7	3.1 - 2.9 - 2.8	4.6 - 4.4 - 4.3
Power Consumption Rated (Min. ~ Max.)	W		410 (110 ~ 880)	620 (100 ~ 2,010)	660 (110 ~ 1,330)	1,000 (100 ~ 2,530)
Power Factor (Rated)	%		93.2 - 93.8 - 89.9	97.2 - 96.3 - 95.7	96.8 - 99.0 - 98.2	98.8 - 98.8 - 96.9
COP Rated (Min. ~ Max.)	W/W		6.10 (5.45 ~ 4.43)	5.80 (6.00 ~ 3.73)	5.30 (5.45 ~ 3.98)	5.00 (6.00 ~ 3.56)
Piping Connections	Liquid	mm	φ 6.4		φ 6.4	
	Gas	mm	φ 9.5		φ 9.5	
Heat Insulation			Both Liquid and Gas Pipes		Both Liquid and Gas Pipes	
Max. Interunit Piping Length	m		10		10	
Max. Interunit Height Difference	m		8		8	
Chargeless	m		10		10	
Indoor Unit			FTXZ25NV1B		FTXZ35NV1B	
Front Panel Colour			White		White	
Airflow Rate	H	m ³ /min (cfm)	10.7 (379)	11.7 (415)	12.1 (428)	13.3 (469)
	M		7.5 (265)	8.6 (303)	8.4 (295)	9.2 (324)
	L		5.3 (188)	6.7 (236)	5.6 (197)	6.9 (245)
	SL		4.0 (141)	4.8 (168)	4.0 (141)	4.8 (168)
Fan	Type		Cross Flow Fan		Cross Flow Fan	
	Motor Output	W	30		30	
	Speed	Steps	5 Steps, Quiet, Auto		5 Steps, Quiet, Auto	
Air Direction Control			Right, Left, Horizontal, Downwards		Right, Left, Horizontal, Downwards	
Air Filter			Auto cleaning filter		Auto cleaning filter	
Running Current (Rated)	A		0.14 - 0.14 - 0.13	0.14 - 0.14 - 0.13	0.14 - 0.14 - 0.13	0.14 - 0.14 - 0.13
Power Consumption (Rated)	W		30 - 30 - 30	30 - 30 - 30	30 - 30 - 30	30 - 30 - 30
Power Factor (Rated)	%		97.4 - 93.2 - 96.2	97.4 - 93.2 - 96.2	97.4 - 93.2 - 96.2	97.4 - 93.2 - 96.2
Temperature Control			Microcomputer Control		Microcomputer Control	
Dimensions (H × W × D)	mm		295 × 798 × 372		295 × 798 × 372	
Packaged Dimensions (H × W × D)	mm		434 × 865 × 361		434 × 865 × 361	
Weight (Mass)	kg		15		15	
Gross Weight (Gross Mass)	kg		19		19	
Sound Pressure Level	H / M / L / SL	dB(A)	38 / 33 / 26 / 19	39 / 35 / 28 / 19	42 / 35 / 27 / 19	42 / 36 / 29 / 19
Sound Power Level (H)		dB	54	56	57	57
Outdoor Unit			RXZ25NV1B		RXZ35NV1B	
Casing Colour			Ivory White		Ivory White	
Compressor	Type		Hermetically Sealed Swing Type		Hermetically Sealed Swing Type	
	Model		2YC40DXD		2YC40DXD	
Refrigerant Oil	Type		FW68DA		FW68DA	
	Charge	L	0.405		0.405	
Refrigerant	Type		R-32		R-32	
	Charge	kg	1.34		1.34	
Airflow Rate	H	m ³ /min (cfm)	31.0 (1,093)	28.3 (999)	34.4 (1,216)	31.5 (1,113)
	L		22.5 (794)	16.2 (571)	22.5 (794)	16.2 (571)
Fan	Type		PZ440		PZ440	
	Motor Output	W	71		71	
Running Current (Rated)	A		1.9 - 1.8 - 1.8	2.8 - 2.7 - 2.6	3.0 - 2.8 - 2.7	4.5 - 4.3 - 4.2
Power Consumption (Rated)	W		380	590	630	970
Power Factor (Rated)	%		90.9 - 91.8 - 88.0	95.8 - 95.0 - 94.6	95.5 - 97.8 - 97.2	98.0 - 98.1 - 96.2
Starting Current	A		2.8		4.4	
Dimensions (H × W × D)	mm		693 × 795 × 300		693 × 795 × 300	
Packaged Dimensions (H × W × D)	mm		735 × 926 × 430		735 × 926 × 430	
Weight (Mass)	kg		50		50	
Gross Weight (Gross Mass)	kg		58		58	
Sound Pressure Level (H)		dB(A)	46	46	48	48
Sound Power Level (H)		dB	59	59	61	61
Drawing No.			3D084168		3D084169	

Notes: ■ The data are based on the conditions shown in the table below.

Cooling	Heating	Piping Length
Indoor ; 27°CDB / 19°CWB Outdoor ; 35°CDB	Indoor ; 20°CDB Outdoor ; 7°CDB / 6°CWB	5 m

■ The maximum allowable refrigerant charge amount is 1.34 kg.

Conversion Formulae
kcal/h = kW × 860 Btu/h = kW × 3412 cfm = m ³ /min × 35.3

50 Hz, 220 - 230 - 240 V

Model	Indoor Unit		FTXZ50NV1B	
	Outdoor Unit		RXZ50NV1B	
			Cooling	Heating
Capacity Rated (Min. ~ Max.)	kW		5.0 (0.6 ~ 5.8)	6.3 (0.6 ~ 9.4)
	Btu/h		17,100 (2,000 ~ 19,400)	21,500 (2,000 ~ 32,000)
	kcal/h		4,300 (520 ~ 4,990)	5,420 (520 ~ 8,080)
Running Current (Rated)	A		5.1 - 4.9 - 4.6	6.5 - 6.2 - 6.0
Power Consumption Rated (Min. ~ Max.)	W		1,100 (110 ~ 1,600)	1,410 (100 ~ 2,640)
Power Factor (Rated)	%		98.0 - 97.6 - 99.6	98.6 - 98.9 - 97.9
COP Rated (Min. ~ Max.)	W/W		4.55 (5.45 ~ 3.63)	4.47 (6.00 ~ 3.55)
Piping Connections	Liquid	mm	φ 6.4	
	Gas	mm	φ 9.5	
Heat Insulation			Both Liquid and Gas Pipes	
Max. Interunit Piping Length	m		10	
Max. Interunit Height Difference	m		8	
Chargeless	m		10	
Indoor Unit		FTXZ50NV1B		
Front Panel Colour			White	
Airflow Rate	H	m³/min (cfm)	15.0 (545)	14.4 (517)
	M		9.2 (326)	10.7 (378)
	L		6.6 (232)	7.7 (274)
	SL		4.6 (164)	5.9 (210)
Fan	Type		Cross Flow Fan	
	Motor Output	W	30	
	Speed	Steps	5 Steps, Quiet, Auto	
Air Direction Control			Right, Left, Horizontal, Downwards	
Air Filter			Auto cleaning filter	
Running Current (Rated)	A		0.14 - 0.14 - 0.13	0.14 - 0.14 - 0.13
Power Consumption (Rated)	W		30 - 30 - 30	30 - 30 - 30
Power Factor (Rated)	%		97.4 - 93.2 - 96.2	97.4 - 93.2 - 96.2
Temperature Control			Microcomputer Control	
Dimensions (H x W x D)	mm		295 x 798 x 372	
Packaged Dimensions (H x W x D)	mm		434 x 865 x 361	
Weight (Mass)	kg		15	
Gross Weight (Gross Mass)	kg		19	
Sound Pressure Level	H / M / L / SL	dB(A)	47 / 38 / 30 / 23	44 / 38 / 31 / 24
Sound Power Level (H)		dB	60	59
Outdoor Unit		RXZ50NV1B		
Casing Colour			Ivory White	
Compressor	Type		Hermetically Sealed Swing Type	
	Model		2YC40DXD	
Refrigerant Oil	Type		FW68DA	
	Charge	L	0.405	
Refrigerant	Type		R-32	
	Charge	kg	1.34	
Airflow Rate	H	m³/min (cfm)	40.4 (1,427)	33.1 (1,170)
	L		22.5 (764)	16.2 (571)
Fan	Type		PZ440	
	Motor Output	W	71	
Running Current (Rated)	A		5.0 - 4.8 - 4.5	6.4 - 6.1 - 5.9
Power Consumption (Rated)	W		1,070	1,380
Power Factor (Rated)	%		97.3 - 96.9 - 99.1	98.0 - 98.4 - 97.5
Starting Current	A		6.2	
Dimensions (H x W x D)	mm		693 x 795 x 300	
Packaged Dimensions (H x W x D)	mm		735 x 926 x 430	
Weight (Mass)	kg		50	
Gross Weight (Gross Mass)	kg		58	
Sound Pressure Level (H)		dB(A)	49	50
Sound Power Level (H)		dB	63	64
Drawing No.			3D084170	

Notes: ■ The data are based on the conditions shown in the table below.

Cooling	Heating	Piping Length
Indoor ; 27°CDB / 19°CWB Outdoor ; 35°CDB	Indoor ; 20°CDB Outdoor ; 7°CDB / 6°CWB	5 m

■ The maximum allowable refrigerant charge amount is 1.34 kg.

Conversion Formulae
kcal/h = kW x 860 Btu/h = kW x 3412 cfm = m³/min x 35.3

Part 3 Printed Circuit Board Connector Wiring Diagram

1. Indoor Unit.....	7
2. Outdoor Unit.....	10

1. Indoor Unit

Control PCB (A1P)

- | | |
|----------------|--|
| 1) S21 | Connector for centralised control (HA) |
| 2) S32 | Connector for indoor heat exchanger thermistor (R1T) |
| 3) S33 | Connector for humidity sensor PCB (A4P) |
| 4) S41 | Connector for swing motors and humidity sensor PCB (A5P) |
| 5) S44 | Connector for brush motor, filter motors, limit switch for brush |
| 6) S46 | Connector for display / signal receiver PCB (A2P) |
| 7) S52 | Connector for high voltage unit PCB (A3P) |
| 8) S53 | Connector for limit switch for streamer |
| 9) S200 | Connector for fan motor |
| 10) H1, H2, H3 | Connector for terminal board |
| 11) FG1 | Connector for frame ground |
| 12) FU1 (F1U) | Fuse (3.15 A, 250 V) |

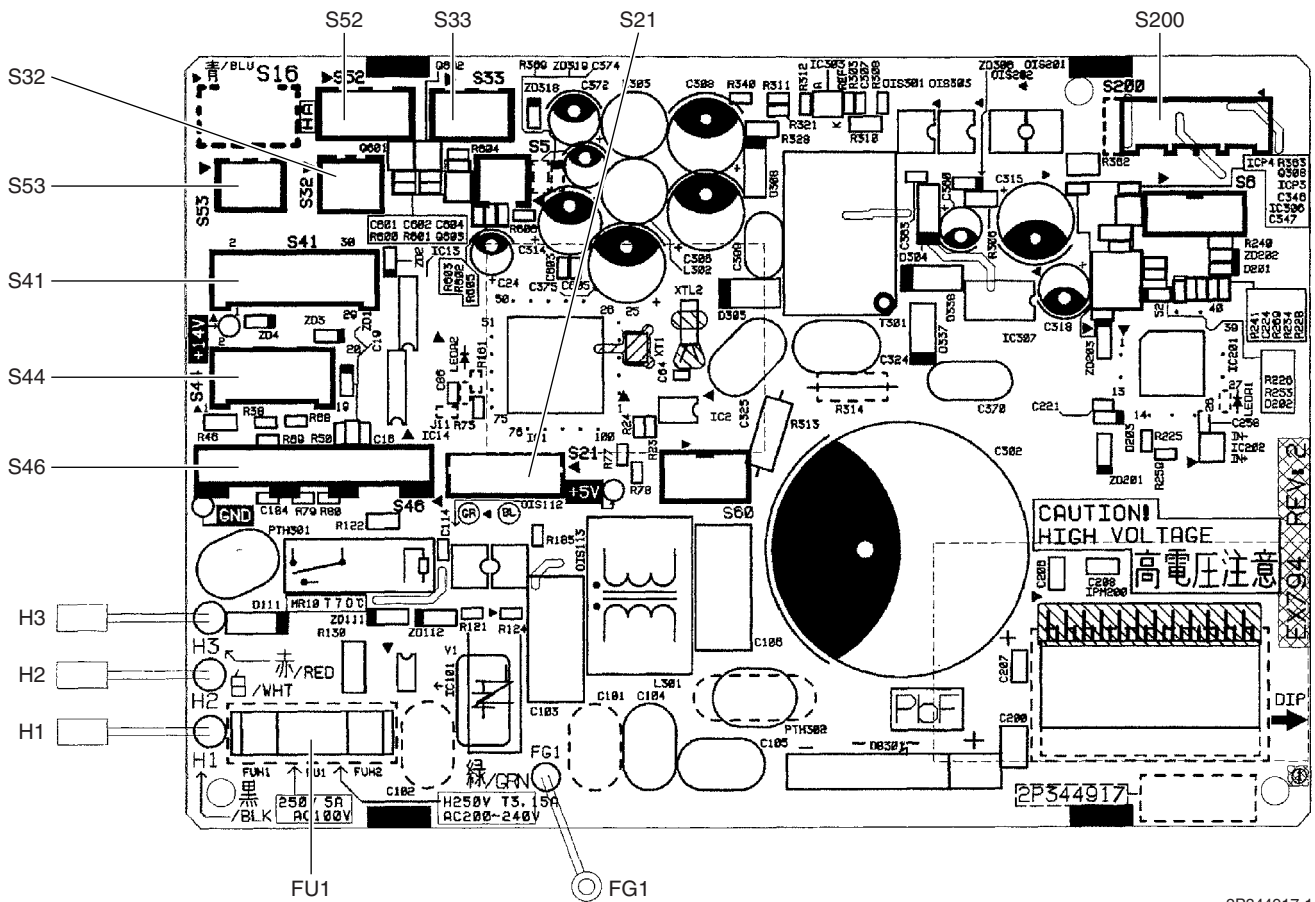

2P344917-1

Display/Signal Receiver PCB (A2P)

- | | |
|----------------|--|
| 1) S26 | Connector for INTELLIGENT EYE sensor PCBs (A6P, A7P) |
| 2) S56 | Connector for control PCB (A1P) |
| 3) SW1 (S1W) | Forced cooling operation ON/OFF button |
| 4) LED1 (H1P) | LED for MOLD PROOF / CLEANING FILTER (green) |
| 5) LED2 (H2P) | LED for timer (yellow) |
| 6) LED4 (H4P) | LED for operation (green) |
| 7) LED5 (H5P) | LED for quick heating timer (red) |
| 8) TFU1 (F1UT) | Thermal fuse (136°C) |

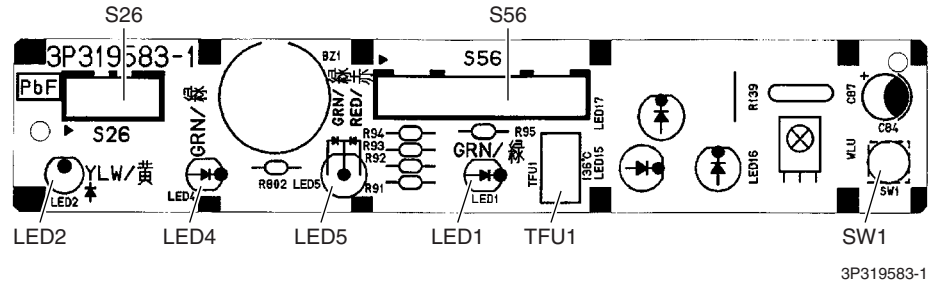

High Voltage Unit PCB (A3P)

- | | |
|----------------|---------------------------------|
| 1) S401 | Connector for control PCB (A1P) |
| 2) B401, CN403 | Connector for streamer |

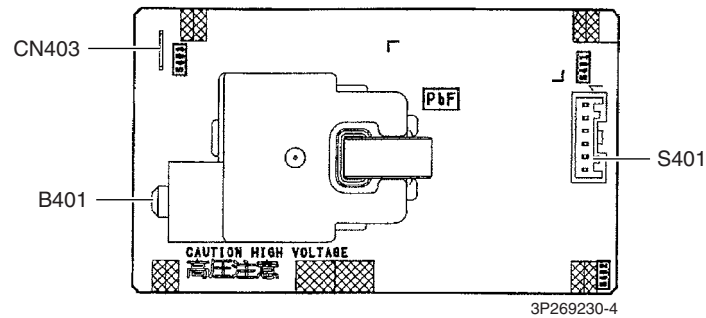

Humidity Sensor PCB (A4P: for room, A5P: for humidifying)

- 1) R2T on A4P
- 2) R3T on A5P

Room temperature thermistor
Humidifying thermistor

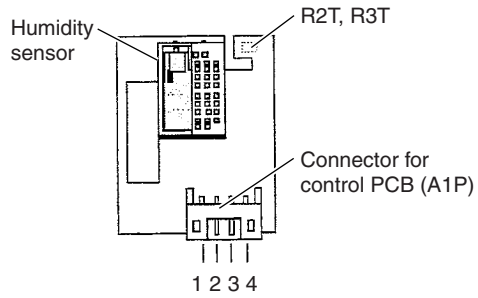

3E860001-1

INTELLIGENT EYE sensor PCB (A6P, A7P)

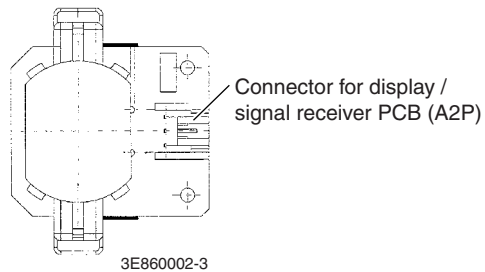

3E860002-3

2. Outdoor Unit

Main PCB (PCB1)

1) S20	Connector for electronic expansion valve coil
2) S21	Connector for humidifying rotor motor and humidifying thermistor
3) S22	Connector for damper motor
4) S40	Connector for overload protector
5) S45	Connector for thermal fuse (102°C)
6) S70	Connector for DC fan motor
7) S72	Connector for humidifier fan motor
8) S80	Connector for four way valve coil
9) S90	Connector for thermistors (outdoor temperature, outdoor heat exchanger, discharge pipe)
10)S91	Connector for liquid pipe thermistor
11)S101	Connector for humidifying heater
12)S501	Connector for limit switch
13)HR1, HR2, HR3, HR4	Connector for reactor
14)HK1, HK2, HK3	Connector for hygroscopic fan motor
15)HL1, HN1, S	Connector for terminal board
16)E1, E2	Connector for earth wire
17)U, V, W	Connector for compressor
18)FU1, FU2	Fuse (3.15 A, 250 V)
19)FU3	Fuse (30 A, 250 V)
20)V3, V5	Varistor
21)LED A	LED for service monitor (green)

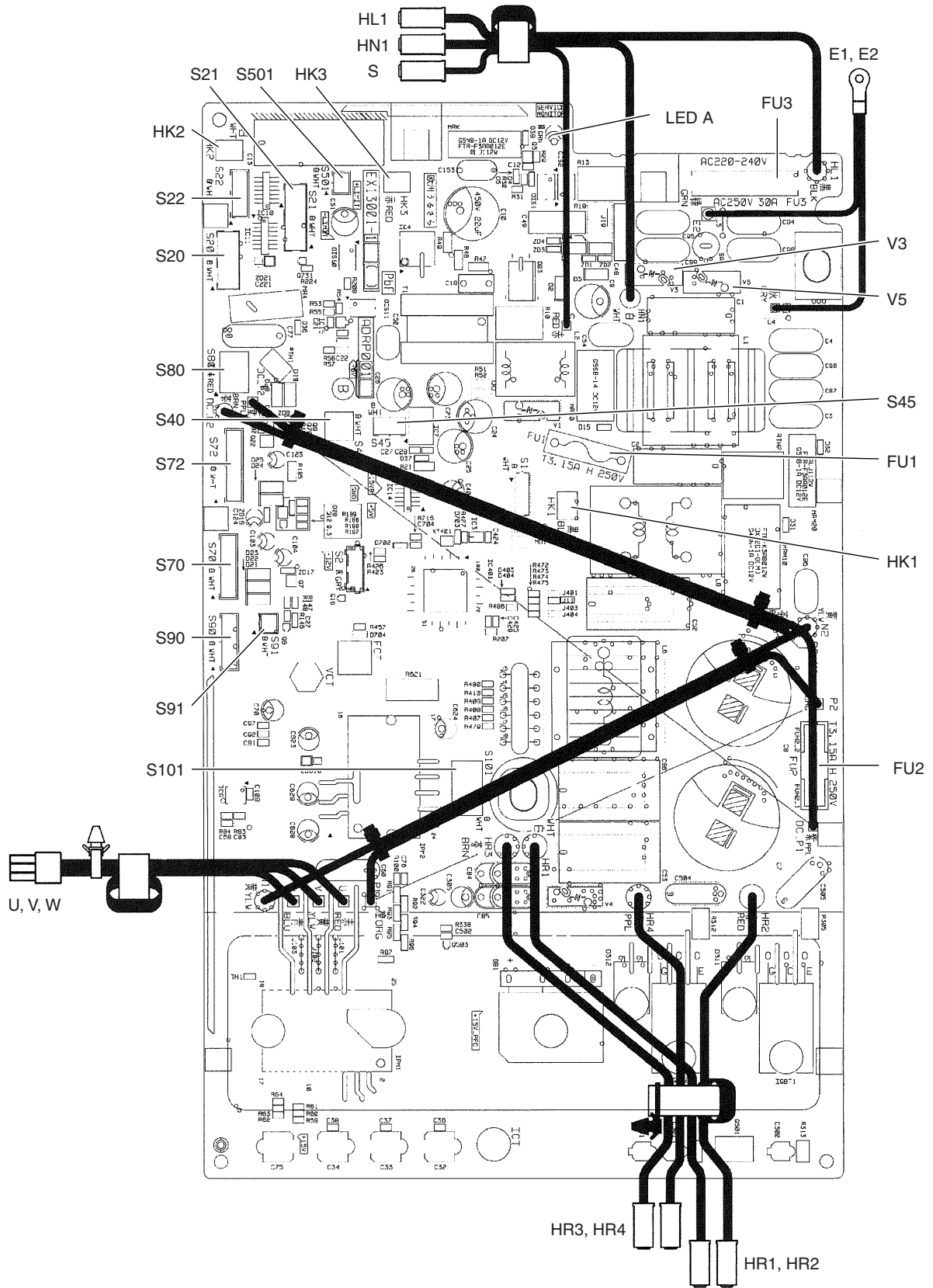

2P345585-2

Part 4

Functions and Control

1. Main Functions.....	13
1.1 Temperature Control.....	13
1.2 Frequency Principle.....	13
1.3 Airflow Direction Control.....	15
1.4 Fan Speed Control for Indoor Unit.....	19
1.5 Thermostat Control.....	20
1.6 URURU HUMIDIFY / HUMID HEATING Operation.....	21
1.7 SARARA DRY / DRY COOLING Operation.....	28
1.8 AUTO Operation.....	31
1.9 Sensor Operation.....	32
1.10 ECONO / OUTDOOR UNIT QUIET Operation.....	34
1.11 POWERFUL Operation.....	35
1.12 Air Purifying and Ventilation.....	36
1.13 MOLD PROOF Operation.....	39
1.14 CLEANING FILTER Operation.....	39
1.15 INFORMATION.....	41
1.16 Brightness Setting of Indoor Unit Lamps.....	41
1.17 TIMER Operation.....	42
1.18 COMFORT SLEEP TIMER Operation.....	43
1.19 QUICK HEATING TIMER Operation.....	43
1.20 Other Functions.....	44
2. Control Specification.....	45
2.1 Frequency Control.....	45
2.2 Controls at Mode Changing / Start-up.....	47
2.3 Discharge Pipe Temperature Control.....	49
2.4 Input Current Control.....	50
2.5 Freeze-up Protection Control.....	51
2.6 Heating Peak-cut Control.....	51
2.7 Draught Prevention Control (Hot-Start Function).....	52
2.8 Dew Prevention Control.....	53
2.9 Outdoor Fan Control.....	53
2.10 Defrost Control.....	54
2.11 Electronic Expansion Valve Control.....	55

1. Main Functions

1.1 Temperature Control

Definitions of Temperatures

The definitions of temperatures are classified as following.

- ◆ Room temperature: temperature of lower part of the room
- ◆ Set temperature: temperature set by remote controller
- ◆ Room thermistor temperature: temperature detected by room temperature thermistor
- ◆ Target temperature: temperature determined by microcomputer

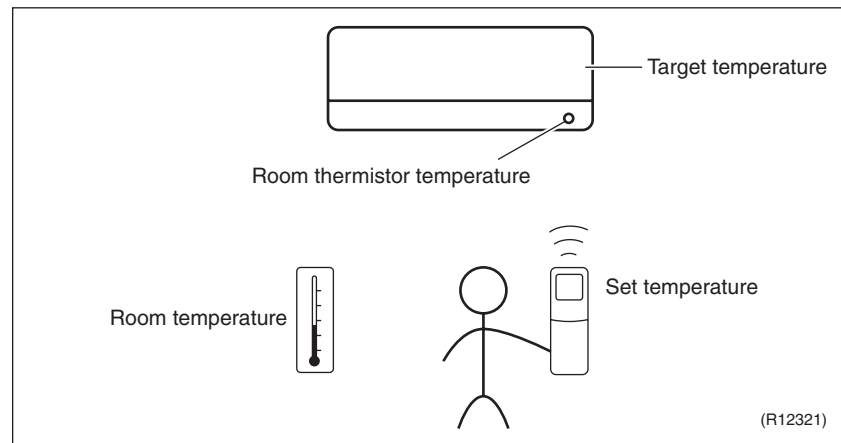

Temperature Control

The temperature of the room is detected by the room temperature thermistor. However, there is a difference between the temperature detected by room temperature thermistor and the temperature of lower part of the room, depending on the type of the indoor unit or installation condition. Practically, the temperature control is done by the target temperature appropriately adjusted for the indoor unit and the temperature detected by room temperature thermistor.

1.2 Frequency Principle

Main Control Parameters

The frequency of the compressor is controlled by the following 2 parameters:

- The load condition of the operating indoor unit
- The difference between the room thermistor temperature and the target temperature

Additional Control Parameters

The target frequency is adapted by additional parameters in the following cases:

- Frequency restrictions
- Initial settings
- Forced cooling operation

Inverter Principle

To regulate the capacity, a frequency control is needed. The inverter makes it possible to vary the rotation speed of the compressor. The following table explains the conversion principle:

Phase	Description
1	The supplied AC power source is converted into the DC power source for the present.
2	The DC power source is reconverted into the three phase AC power source with variable frequency. <ul style="list-style-type: none"> ■ When the frequency increases, the rotation speed of the compressor increases resulting in an increase of refrigerant circulation. This leads to a larger amount of heat exchange per unit. ■ When the frequency decreases, the rotation speed of the compressor decreases resulting in a decrease of refrigerant circulation. This leads to a smaller amount of heat exchange per unit.

Drawing of Inverter

The following drawing shows a schematic view of the inverter principle:

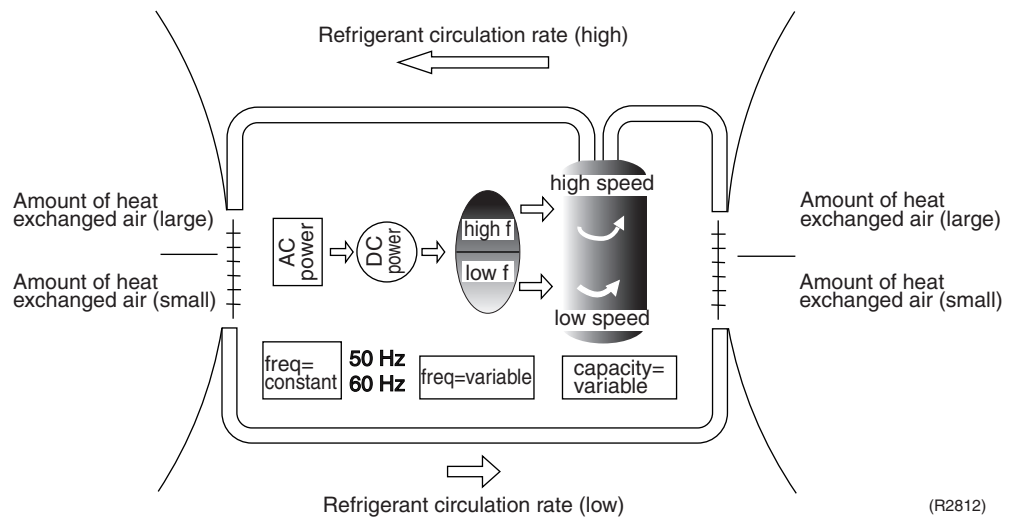

Inverter Features

The inverter provides the following features:

- The regulating capacity can be changed according to the changes in the outdoor temperature and cooling / heating load.
- Quick heating and quick cooling
The rotation speed of the compressor is increased when starting the heating (or cooling). This enables to reach the set temperature quickly.
- Even during extreme cold weather, the high capacity is achieved. It is maintained even when the outdoor temperature is 2°C.
- Comfortable air conditioning
A fine adjustment is integrated to keep the room temperature constant.
- Energy saving heating and cooling
Once the set temperature is reached, the energy saving operation enables to maintain the room temperature at low power.

Frequency Limits

The following functions regulate the minimum and maximum frequency:

Frequency	Functions
Low	<ul style="list-style-type: none"> ■ Four way valve operation compensation. Refer to page 47.
High	<ul style="list-style-type: none"> ■ Compressor protection function. Refer to page 48. ■ Discharge pipe temperature control. Refer to page 49. ■ Input current control. Refer to page 50. ■ Freeze-up protection control. Refer to page 51. ■ Heating peak-cut control. Refer to page 51. ■ Defrost control. Refer to page 54.

Forced Cooling Operation

Refer to page 194 for details.

1.3 Airflow Direction Control

Operation

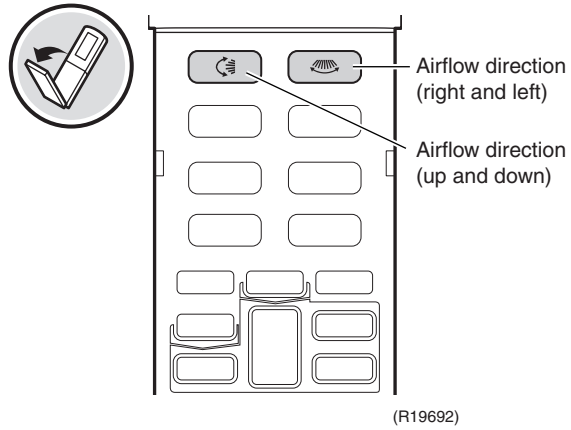

* Refer to the operation manual for details.

1.3.1 Auto-Swing

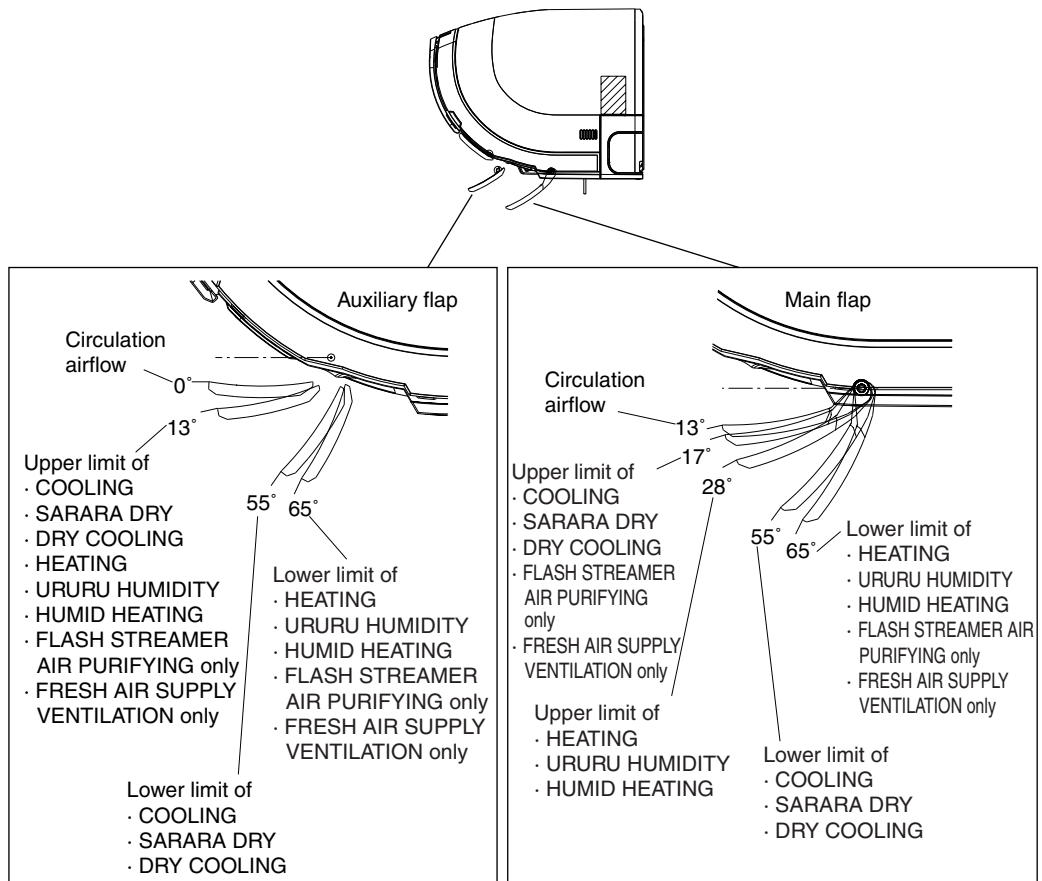

1.3.2 Room Shape and Installation Position

Airflow direction is properly controlled by setting the room shape and installation position of the indoor unit in the SET UP menu of the remote controller.

The angle of the flap will be set facing higher than the default setting when the room shape is set to horizontal.

Refer to the operation manual for details.

When **Circulate setting** is set to **Low** in the service setting menu of the remote controller, the flap position for oblong room setting is about the same as for horizontal room setting.

Refer to page 196.

1.3.3 Circulation Airflow, BREEZE Airflow, Comfort Airflow

Outline

- As the auxiliary flap turns the airflow toward the ceiling, it sends the air far in cooling operation, or stirs the warm air near the ceiling in heating operation, to resolve the temperature unevenness not only horizontally but also vertically.
- The flaps are set facing higher than the usual position, so as to turn the airflow toward the ceiling.

■ Circulation Airflow

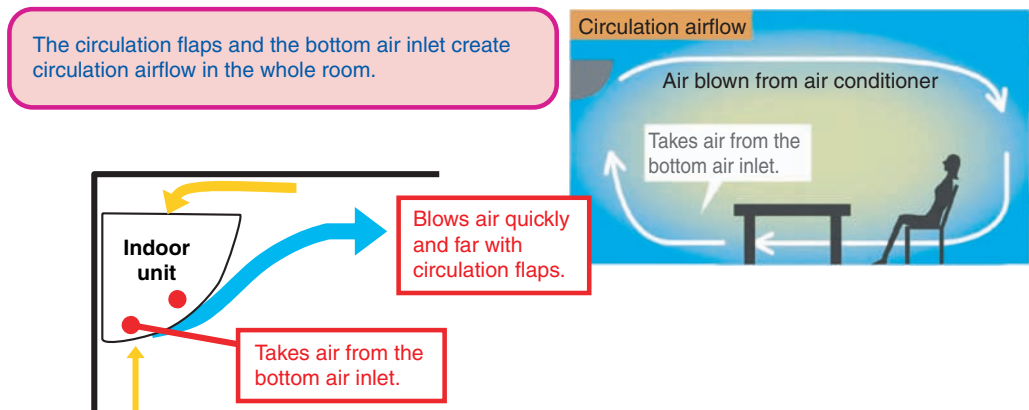

(R19694)

■ BREEZE Airflow

- When the up/down airflow direction is set to **BREEZE**, BREEZE airflow starts generating breeze-like airflow.
- There are several patterns of swinging main flap (lower) and auxiliary flap (upper) with intervals. These patterns appear in random order.
- While according to the set airflow rate, fan speed is slightly changed from the set airflow rate by a random amount in order to simulate natural wind.
- The range of airflow rate fluctuation can be changed as preferred (**Auto, Low**) with the remote controller.

■ Comfort Airflow

- Comfort airflow adjusts the airflow direction to avoid directly blowing at a person.
- Refer to 3-Area INTELLIGENT EYE Operation on page 32 for details.

Detail

■ COOLING, DRY COOLING

- When the up/down airflow direction is set to **Circulation**, circulation airflow starts.
- When the up/down airflow direction is set to **AUTO**, operation starts in circulation airflow, then switches to BREEZE airflow when the room temperature becomes stable.
- Once it switches to BREEZE airflow, it does not switch back to circulation airflow.
- When you want to switch back to circulation airflow, set the up/down airflow direction to **AUTO** again.
- Circulation airflow switches to BREEZE airflow when the conditions below continue for 10 minutes.
 - (1) Thermostat off
 - OR
 - (2) Temperature difference is in the range of zone E or lower.

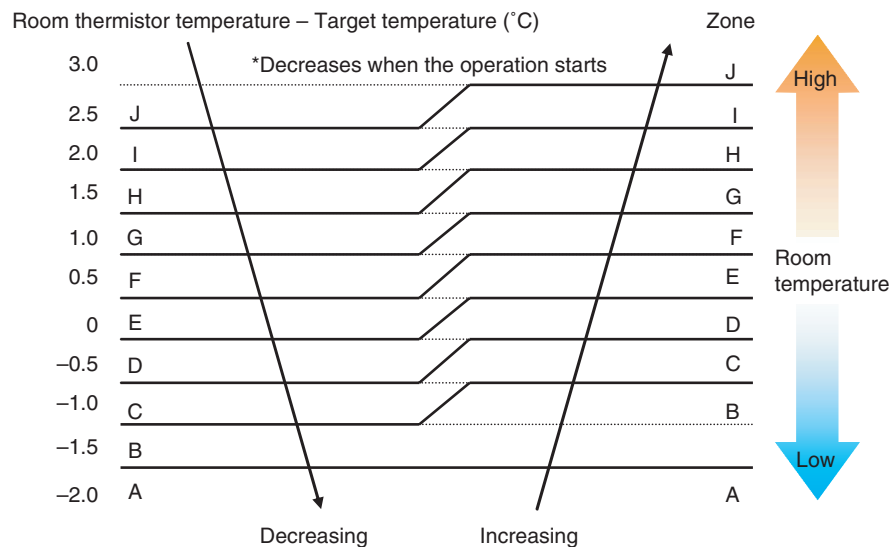

(R19695)

■ SARARA DRY

- When the up/down airflow direction is set to **Circulation**, circulation airflow starts.
- When the up/down airflow direction is set to **AUTO**, operation starts in circulation airflow, then switches to BREEZE airflow when the room temperature becomes stable.

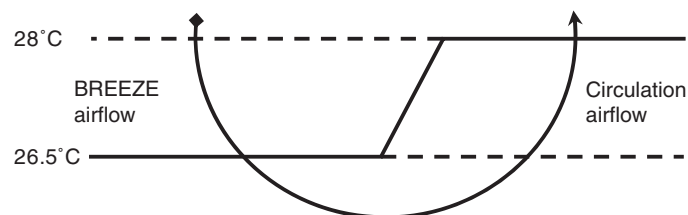

(R20201)

■ HEATING, HUMID HEATING

When the up/down airflow direction is set to **AUTO**, if the room temperature is within the zone A - E, circulation airflow starts. If the room temperature is within the zone F - L, comfort airflow starts.

Comfort airflow starts after operating in circulation airflow for 1 minute.

Operation is shifted from comfort airflow to circulation airflow when the conditions below continue for 5 minutes.

Zone	A ~ E
Compressor frequency	22 Hz or lower

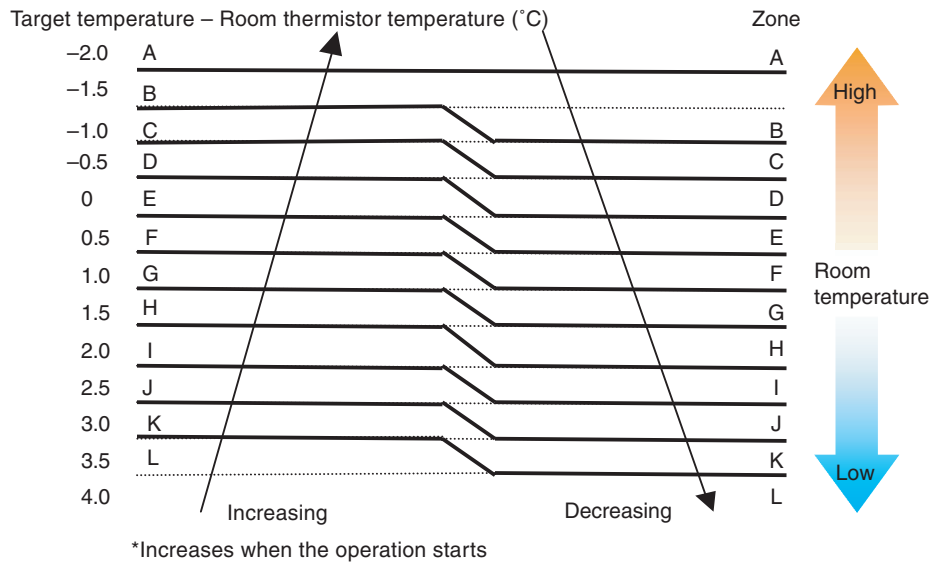

(R19696)

■ URURU HUMIDIFY

When the up/down airflow direction is set to **AUTO**, circulation airflow starts.



1.4 Fan Speed Control for Indoor Unit

Outline

Phase control and fan speed control contains 9 steps: LLL, LL, SL, L, ML, M, MH, H, and HH. The airflow rate can be automatically controlled depending on the difference between the room thermistor temperature and the target temperature.

Automatic Fan Speed Control

In automatic fan speed operation, the step SL is not available.

Step	Cooling	Heating
LLL	 (R11681)	 (R6834)
LL		
L		
ML		
M		
MH		
H		
HH (POWERFUL)		

 = The airflow rate is automatically controlled within this range when the **FAN** button is set to automatic.

<Cooling>

The following drawing explains the principle of fan speed control for cooling.

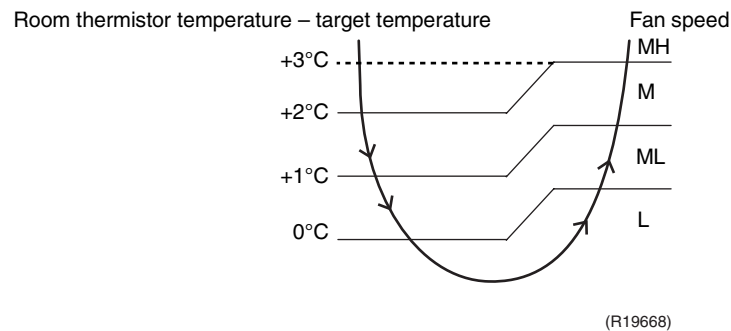

<Heating>

In heating operation, the fan speed is regulated according to the indoor heat exchanger temperature and the difference between the room thermistor temperature and the target temperature.

Indoor Unit Quiet Operation

Forced dropping of the fan tap decreases the airflow rate and reduces airflow noise. (Noise is reduced by about 3 dB as compared to that in L tap.)

Note

- Airflow rate can not be set.
- Since the performance is lowered as compared to that in normal operation (70% under rated conditions), the room may not be cooled or heated when this operation is used for a long time.
- Indoor unit quiet operation is kept in memory even when the power supply is turned OFF. The indication remains on the display of the wireless remote controller and the indoor unit quiet operation works when the power is turned ON again.

1.5 Thermostat Control

Outline

Thermostat control is based on the difference between the room thermistor temperature and the target temperature.

Detail

Thermostat OFF Condition

- ◆ The temperature difference is in the zone A.

Thermostat ON Conditions

- ◆ The temperature difference returns to the zone C after being in the zone A.
- ◆ The system resumes from defrost control in any zones except A.
- ◆ The operation turns on in any zones except A.
- ◆ The monitoring time has passed while the temperature difference is in the zone B.
(Cooling : 10 minutes, Heating : 10 seconds)

<Cooling>

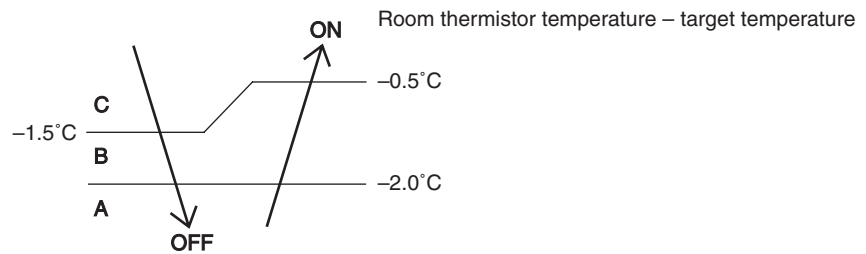

<Heating>

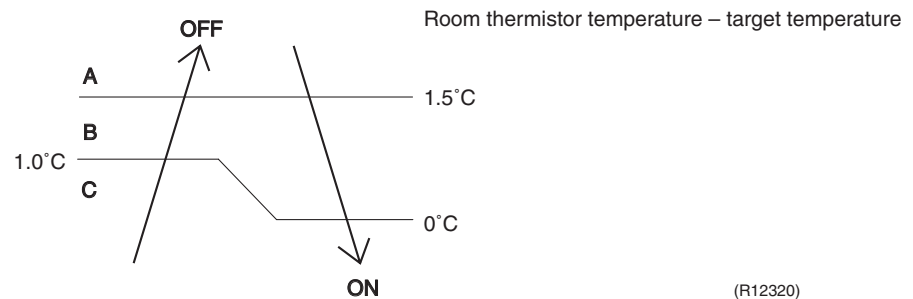

Refer to Temperature Control on page 13 for details.

1.6 URURU HUMIDIFY / HUMID HEATING Operation

Operation

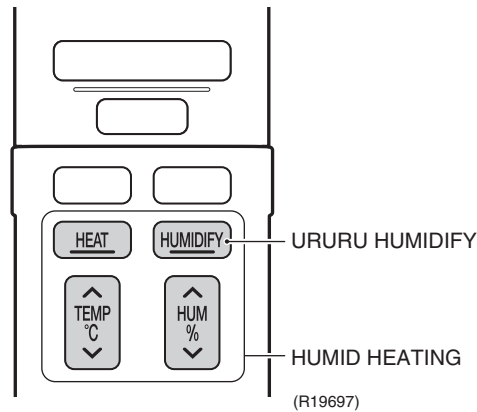

* Refer to the operation manual for details.

Features

■ Humidifying method

Moisture is taken from the outdoor air with the hygroscopic element mounted in outdoor unit, and sent to indoor. This has enabled powerful and speedy humidification.



(R13859)

■ The room is uniformly humidified.

- Humidifier + heating operation by air conditioner

Moisture gathers around the ceiling, as it is lighter than the air even if the humidifier is operated. The air on the floor is kept dry.

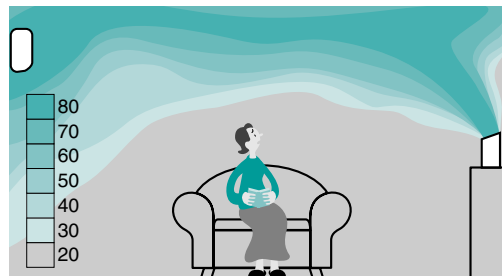

When using humidifier, moisture gathers around the ceiling.

(R3325)

- **URURU HUMIDIFY** operation
This air conditioner enables uniformly humidifying the room by circulating moisture with warm air.

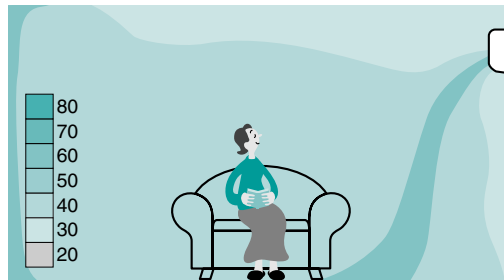

The room is uniformly humidified.

(R3326)

■ Powerful humidifying ability

Model	25 class	35 class	50 class
Humidifying capacity	425 ml/h	500 ml/h	600 ml/h

The values above are measured at 7°C DB / 6°C WB of outdoor air and with 4 m of humidifying hose length.

■ No need for water supply nor cleaning

Water supply and cleaning are unnecessary as it does not have water tank, unlike humidifiers, and there is no proliferations of bacteria.

■ Humidity control

The target of the humidity level is 40 to 50%RH.

You can select from **LOW**, **STD** (standard), **HI** (high), **CONT** (continuous), and **MOISTURISING**. The target humidity cannot be set by %.

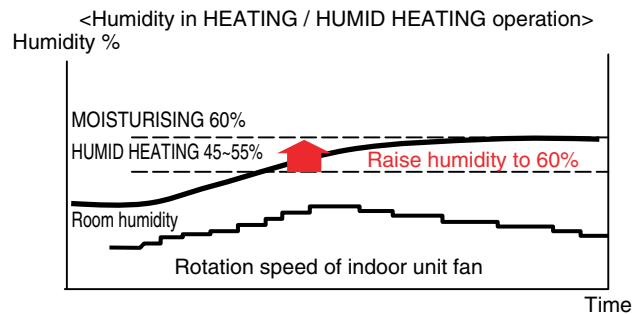

- **MOISTURISING** setting keeps the humidity 60%.
- Air is moisturised more than ordinary **HUMID HEATING**.

(R19670)



Note

- When the outdoor temperature and humidity are low, the humidifying capacity is decreased. In addition, the moisture in the room may not attain sufficient humidity when the ventilation volume is high, the preset temperature is high, or the preset humidity is high.
- After the **HUMID HEATING** operation starts, the relative humidity in the room lowers temporarily. This phenomenon is caused by the increase of the saturation water vapour. Therefore, the humidity raises gradually after the temperature reaches the preset temperature.
- In the humidifying operation, the operation sound increases by about 2 dB both in the indoor unit and outdoor unit. (When the airflow rate is in L or SL, the operation sound increases by about 3 dB in the indoor unit.)
- This system does not suppose the storage of musical instruments or the like.

Conditions for Humidifying Operation

While heating mode, humidifying operation can be available when the following conditions 1 ~ 5 are met at the same time.

1. Indoor heat exchanger temperature is 12°C or more.
2. Outdoor temperature is from -10°C to 24°C (meanwhile, in trial operation, up to 34°C is possible). Humidifying operation does not work under -10°C.
3. Approximately 1 minute has already passed after heating operation startup. (See Note.)
4. Heating operation does not work to its full capacity. (Meanwhile, the continuous humidification is selected, humidifying operation has the priority.)
5. Room humidity is under 70%RH.



Note

Exclude the case when it is recovered from thermostat-off or when the defrost operation finished.

How to Check the Motion of Humidifying Operation

You can check whether the humidifier unit is in good working order. If you conduct humidifying trial operation, you can check even beyond the range of the normal conditions for humidifying operation.

1. Hygroscopic fan Check if air is exhaled from the front outlet of the humidifier unit.
2. Humidifying fan / heater / damper Check if warm air is blown from the duct of outdoor unit.
3. Humidifying rotor Check if the rotor is rotating with the top panel off.

As for the performance, estimate from psychrometric chart with the measured temperature and humidity of the outdoor air and of the humidified air (in front of the indoor outlet) using thermal hygrometer.

Humidity Fluctuation by Temperature Settings

At HUMID HEATING operation, as room temperature rises, relative humidity is temporarily lowered. This is because as room temperature rises, relative humidity is lowered even if the moisture content is the same.

e.g.) The rise in the room temperature from 15°C to 25°C results in the fall in humidity from 40%RH to about 22%RH.

As humidifying operation starts concurrently with heating, humidity rises gradually as shown in the figure below.

Some room conditions (room size, ventilation frequency, number of residents, etc.) and set temperature (higher temperature) may result in unsatisfactory humidity.

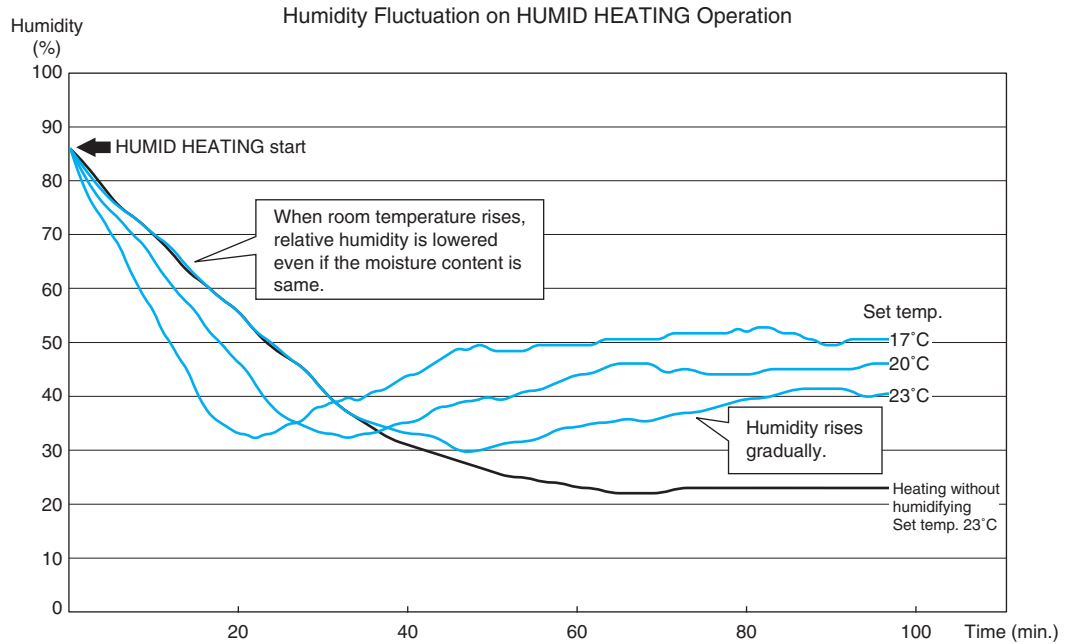

Measurement conditions
 Outdoor temp.: 7°C
 Humidity setting: CONT (continuous)
 Airflow rate setting: H tap
 Area of the room: 26.4 m²
 Humidifying hose length: 7.5 m
 Ventilation rate: 0.75 times/hour
 0.5 times of natural ventilation
 0.25 times of humidity absorption by a carpet, a curtain, etc.

(R13861)

Time chart for humidifying operation control

Approximately 1 minute after heating operation starts, hose drying operation starts and blows the warmed air into the room at a strong airflow rate, then humidifying operation starts.

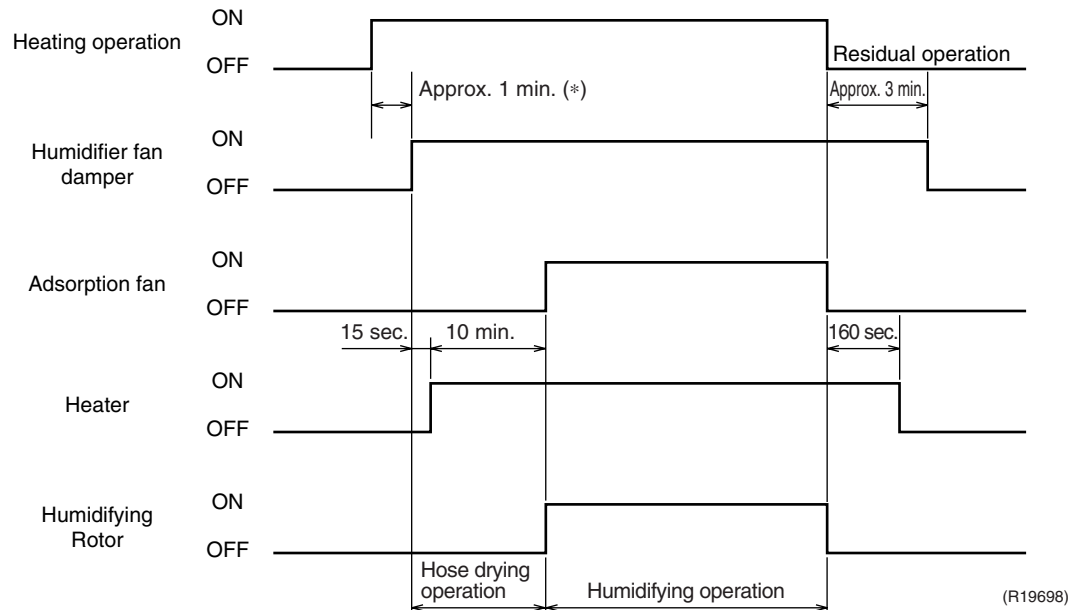

* Humidifying only operation has no 1 minute delay.

Hose drying operation

To prevent dew condensation in the humidifying hose, the hose drying operation may start when the change in the discharge temperature and humidity of the humidified air cannot be detected.

Discharge temperature of the humidified air and the rotation speed of the humidifying rotor are detected every 90 seconds.

The discharge temperature and humidity of the humidified air are recorded if the following conditions are met.

- The discharge temperature of the humidified air is lower than 28°C.
- AND
- The rotation speed of the humidifying rotor is higher than the previous record.

The system extracts the highest and the lowest values of the temperature and humidity of the humidified air from the latest record and past 6 data.

When the following conditions are met, the system judges there is no change and starts the hose drying operation.

- The difference between the maximum and minimum discharge temperature of the humidified air is less than 2°C.

AND

- The difference between the maximum and minimum humidity of the humidified air is less than 3%.

Performance correction by hose length

The maximum piping length is set to 10 m, but the humidifying capacity varies with the length of the humidifying hose.

When the hose length increases by 2 m, the humidifying capacity decreases by about 10%.

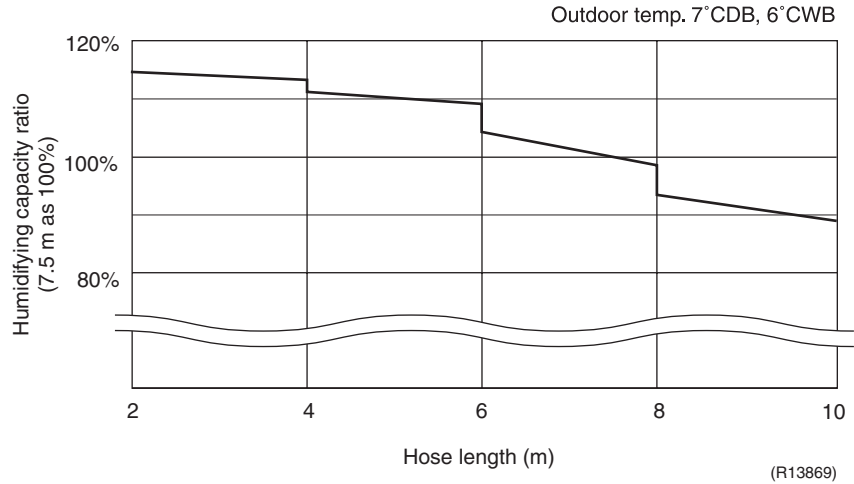

Reference

■ **Room humidity (humidity of the discharged air) by ventilation rate (16 m², hose length: 4 m, 25 class)**

1. Outdoor temp. 0°CDB, 50%RH

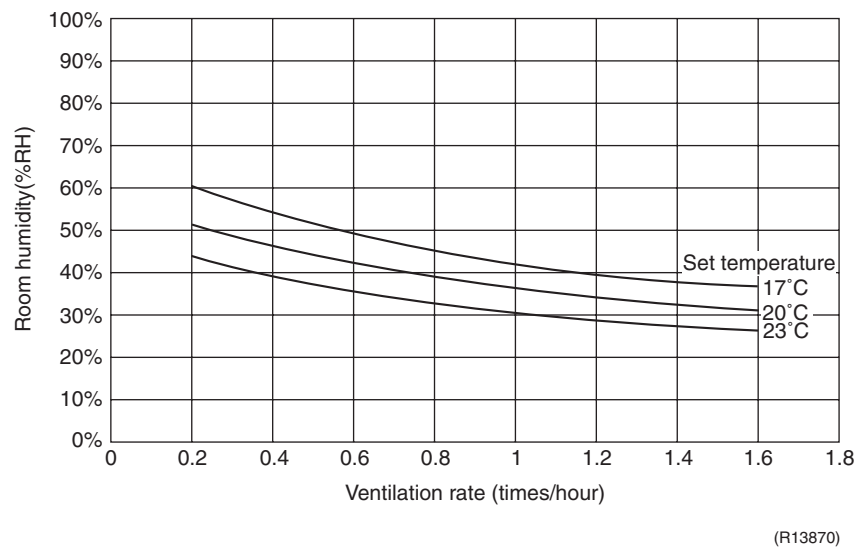

2. Outdoor temp. 7°CDB, 87%RH

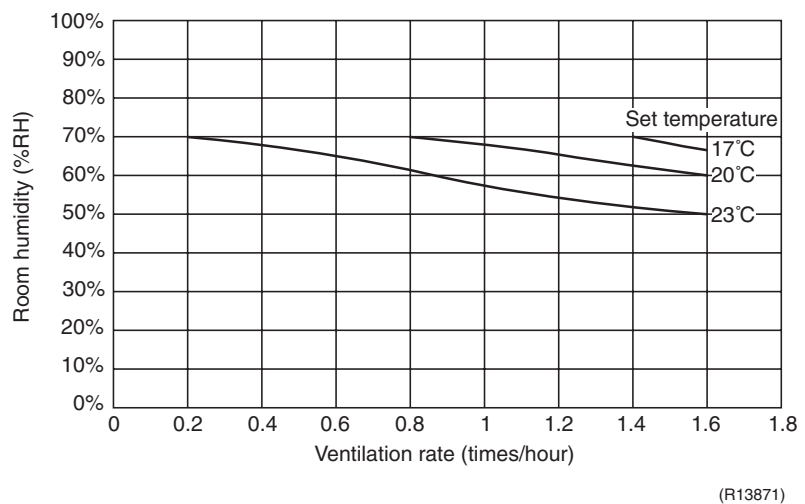

■ Room humidity (humidity of the discharged air) by outdoor temperature
 (16 m², hose length: 4 m, ventilation rate: 0.75 times/hour, 25 class)

1. Room temp. 17°CDB

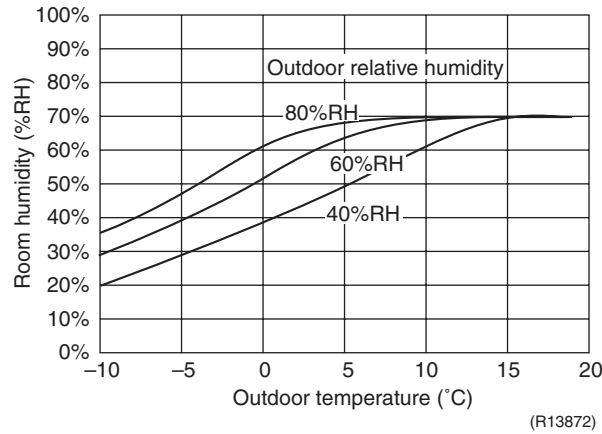

2. Room temp. 20°CDB

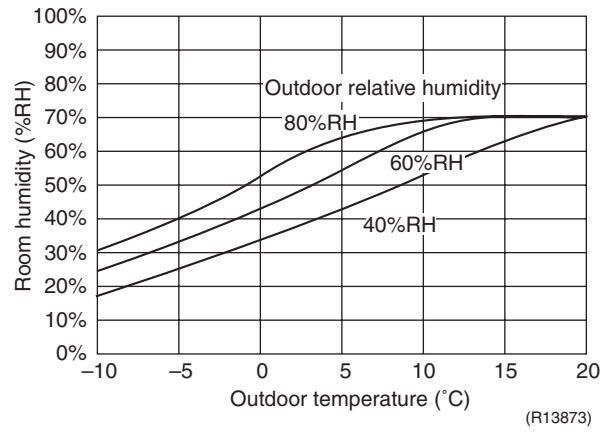

3. Room temp. 23°CDB

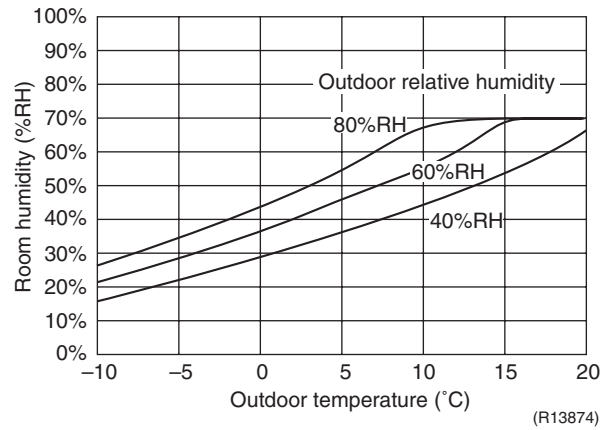

1.7 SARARA DRY / DRY COOLING Operation

Operation

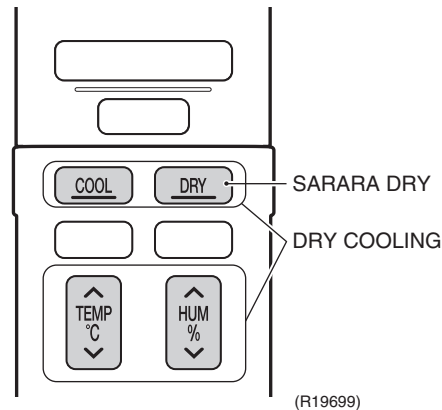

* Refer to the operation manual for details.

Features of SARARA DRY

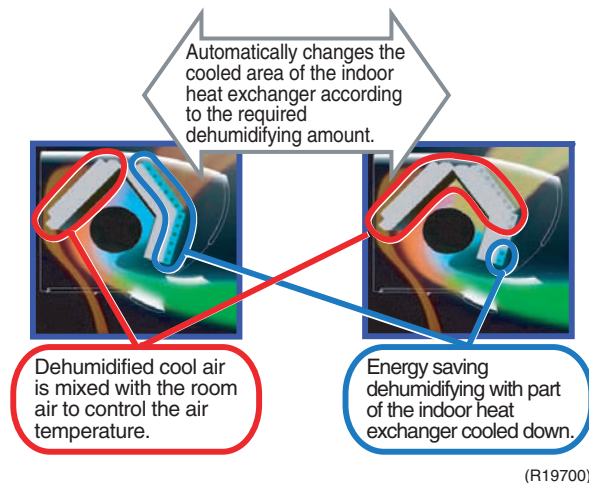

Energy saving dehumidifying is realised by cooling down the part of the indoor heat exchanger. Dehumidified cool air is mixed with the room air to be near room temperature and blown into the room. The area of indoor heat exchanger used for dehumidifying is automatically controlled according to the required dehumidifying amount. The larger/smaller the required dehumidifying amount, the larger/smaller the heat exchange area.



Note

When the required dehumidifying amount is large, the amount of room air mixed with dehumidified cool air is small. Therefore, the room temperature drops according to the decrease of the discharge air temperature.

Explanation of SARARA DRY Operation with Psychrometric Chart

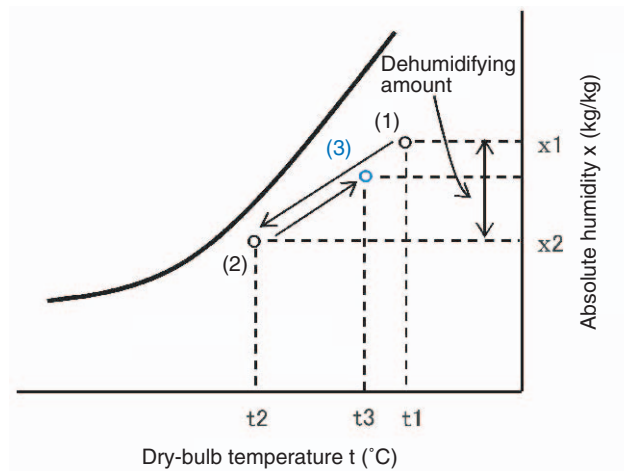

(R19701)

- (1) Suction air
- (2) Suction air (the air passing through the cooled part of indoor heat exchanger) is dehumidified.
- (3) Dehumidified air is mixed with the room air.

■ Dehumidifying amount

Effective airflow rate changes according to the required dehumidifying amount. The larger the required dehumidifying amount is, the larger the effective airflow rate becomes. Although the difference of absolute humidity is constant, the dehumidifying amount increases.

■ Discharge air temperature

The amount of room air to be mixed with dehumidified air changes according to the required dehumidifying amount. The larger the required dehumidifying amount is, the larger the effective airflow rate for dehumidifying becomes. Consequently, the available volume of room air to be mixed and the discharge air temperature also decrease.

Reference Data for SARARA DRY Operation

Sensible heat	Dehumidifying amount	Discharge air temperature (difference from suction air temperature)
300 W (300 W ~ 1,050 W)	230 cc (230 cc ~ 1,000 cc)	-2°C (-2°C ~ -8°C)

<Condition>

Room temperature: 24°CDB, 60%RH(18.5°CWB)

Outdoor temperature: 24°CDB, 80%RH(21.5°CWB)



Note

- The larger the required dehumidifying amount is, the more the sensible heat increases, and the discharge air temperature decreases.
- The smaller the air conditioning sensible heat load is, the lower the room temperature drops.
- The drop of room temperature after operation start is within 3 degrees as SARARA DRY operation has a thermostat off point.

MOISTURISING Setting

- You can select from **HI** (high), **STD** (standard), **LOW**, **CONT** (continuous), and **MOISTURISING**. The target humidity cannot be set by %.

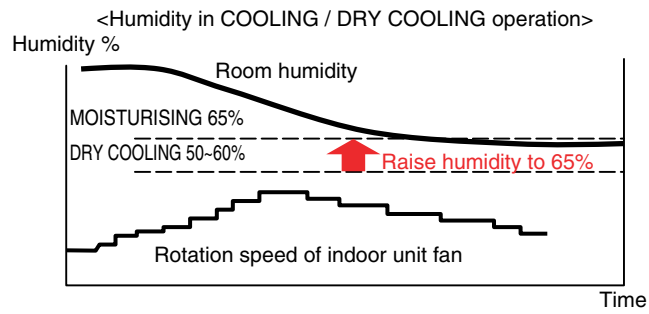

- MOISTURISING setting keeps the humidity 65%.
- Being unlike ordinary DRY COOLING, it prevents the room from drying.

(R19669)

1.8 AUTO Operation

Operation

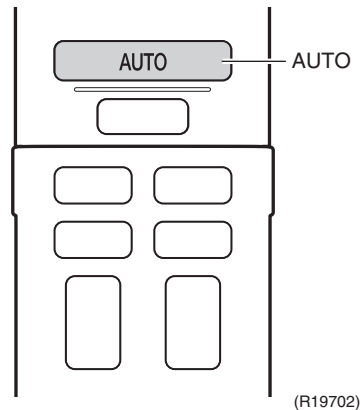

(R19702)

* Refer to the operation manual for details.

Outline

Automatic Cooling / Heating Function

When the AUTO operation is selected with the remote controller, the microcomputer automatically determines the operation mode as cooling or heating according to the room temperature and the set temperature at start-up.

The unit automatically switches the operation mode to maintain the room temperature at the set temperature.

Detail

Ts: set temperature (set by remote controller)

Tt: target temperature (determined by microcomputer)

Tr: room thermistor temperature (detected by room temperature thermistor)

C: correction value

- The set temperature (Ts) determines the target temperature (Tt).
(Ts = 18 ~ 30°C).
- The target temperature (Tt) is calculated as;
 $Tt = Ts + C$
where C is the correction value.
 $C = 0^\circ\text{C}$
- Thermostat ON/OFF point and operation mode switching point are as follows.
Tr means the room thermistor temperature.
 - Heating → Cooling switching point:
 $Tr \geq Tt + 2.5^\circ\text{C}$
 - Cooling → Heating switching point:
 $Tr < Tt - 2.5^\circ\text{C}$
 - Thermostat ON/OFF point is the same as the ON/OFF point of cooling or heating operation.
- During initial operation
 $Tr \geq Ts$: Cooling operation
 $Tr < Ts$: Heating operation

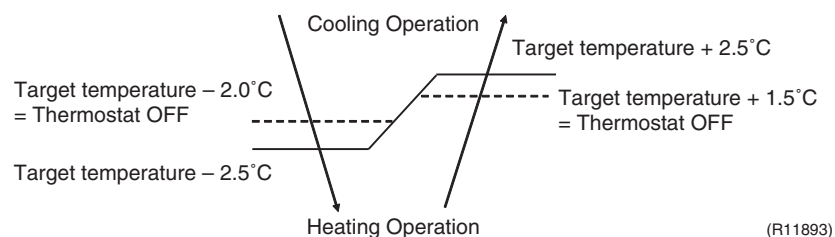

(R11893)

Ex: When the target temperature is 25°C

Cooling → 23.0°C: Thermostat OFF → 22.0°C: Switch to heating

Heating → 26.5°C: Thermostat OFF → 27.5°C: Switch to cooling

1.9 Sensor Operation

Operation

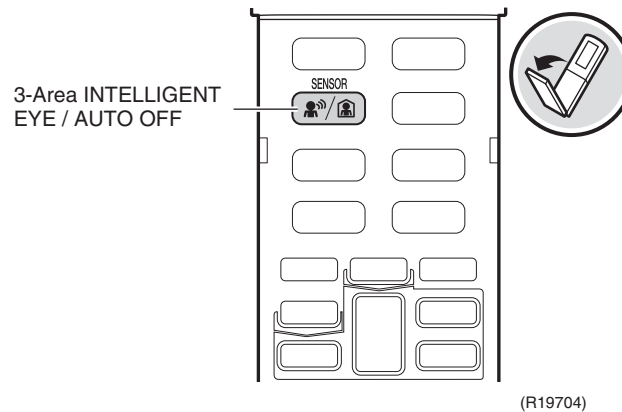

* Refer to the operation manual for details.

1.9.1 3-Area INTELLIGENT EYE Operation

Outline

The 2 INTELLIGENT EYE sensors detect the presence of the user by dividing the room (sensor range) into 3 areas, to decide whether to blow air directly at or to avoid a person. The 2 INTELLIGENT EYE sensors judge whether there is a person according to the signals from the 2 sensors for 3 areas (left, centre, right).

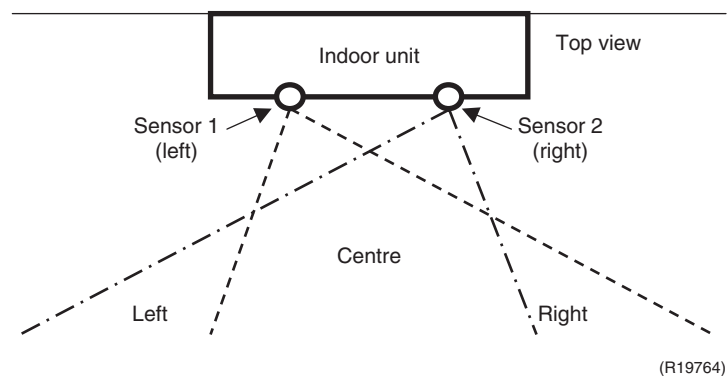

Detail

■ Comfort or Focus

Comfort or **Focus** can be selected in remote controller.

Comfort: Adjusts the airflow direction to avoid directly blowing at a person.

Focus: Adjusts the airflow direction to directly blow at a person.

Flap movement

- (1) When **Comfort** is set and the INTELLIGENT EYE sensor detects a person
 - Horizontal flap: It blows air downward in heating operation, upward in cooling operation.
 - Vertical flap: It adjusts the airflow to avoid directly blowing at a person.
- (2) When **Focus** is set and the INTELLIGENT EYE sensor detects a person
 - Horizontal flap: It adjusts the airflow direction so that the maximum airflow rate is achieved.
 - Vertical flap: It blows air to directly blow at a person.

■ Detection Method

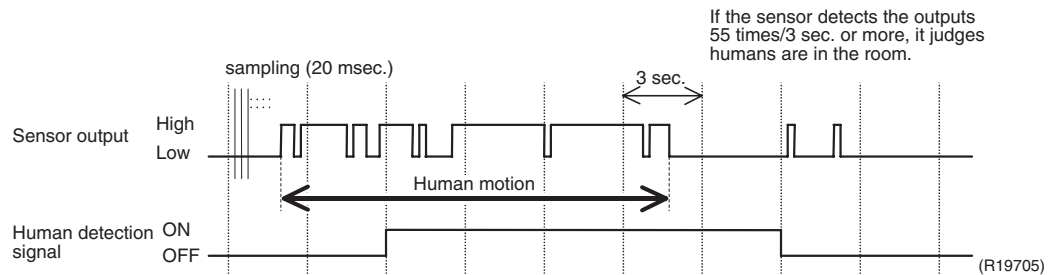

- The sensor detects human motion by receiving infrared rays and displays the pulse wave output.
- The microcomputer in the indoor unit carries out a sampling every 20 msec. and if it detects 55 cycles of the wave in 3 seconds in total, it judges humans are in the room as the motion signal is ON.
- The sensor may detect human motion with up to 20 msec latency.

■ Ex. Cooling

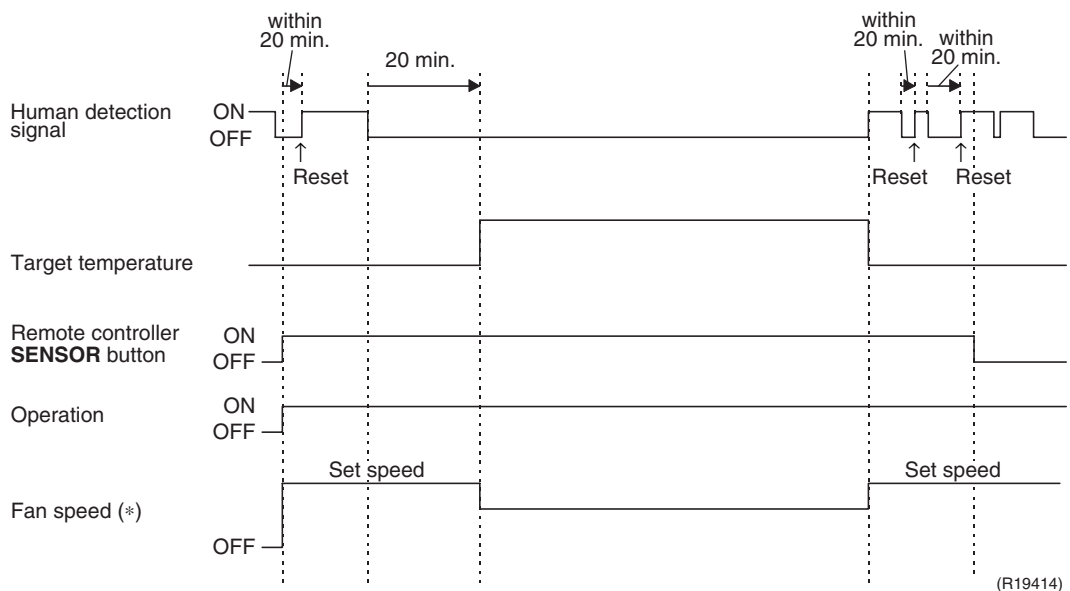

- * In FAN operation, the fan speed is reduced by 100 rpm.
- When the microcomputer does not have a signal from the sensor in 20 minutes, it judges that nobody is in the room and operates the unit at a temperature shifted from the target temperature. (Cooling: 1 ~ 2°C higher, Heating: 2°C lower.)



Note For dry operation, you cannot set the temperature with a remote controller, but the target temperature is shifted internally.

1.9.2 AUTO OFF Operation

- When the INTELLIGENT EYE sensor judges that there is no one in the room, the set temperature is shifted by +2°C in COOLING / -2°C in HEATING operation. When the set time elapses with no change in the condition, the air conditioner automatically stops the operation.
- If **INTELLIGENT EYE** is off and **AUTO OFF** is on, the operation stops after the set period of time.

1.10 ECONO / OUTDOOR UNIT QUIET Operation

Operation

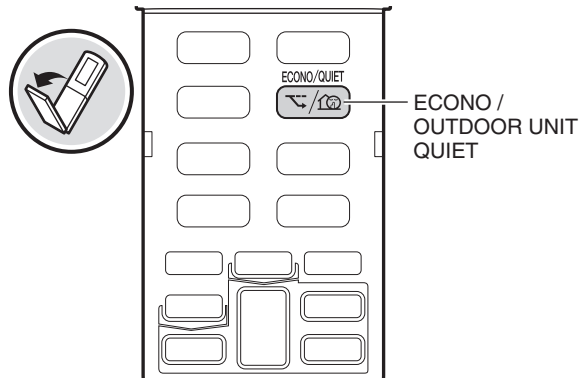

(R19706)

* Refer to the operation manual for details.

1.10.1 ECONO Operation

- ECONO operation reduces the maximum operating current and the power consumption. This operation is particularly convenient for energy-saving-oriented users. It is also a major bonus for those whose breaker capacities do not allow the use of multiple electrical devices and air conditioners.
- When this function is activated, the maximum capacity also decreases.
- ECONO operation can be available when the unit is running.
- ECONO operation and POWERFUL operation cannot be used at the same time. The latest command has the priority.

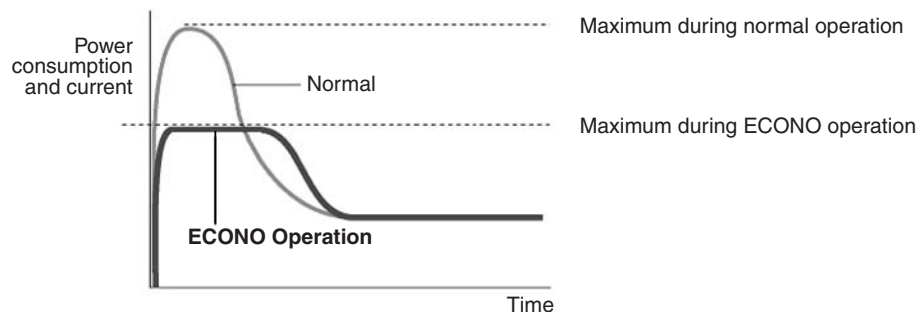

(R9288)

1.10.2 OUTDOOR UNIT QUIET Operation

- OUTDOOR UNIT QUIET operation lowers the noise level of the outdoor unit by changing the frequency and fan speed on the outdoor unit. This function is useful when you need to consider minimising noise in your neighbourhood, such as during the night.
- OUTDOOR UNIT QUIET operation and POWERFUL operation cannot be used at the same time. The latest command has the priority.

1.11 POWERFUL Operation

Operation

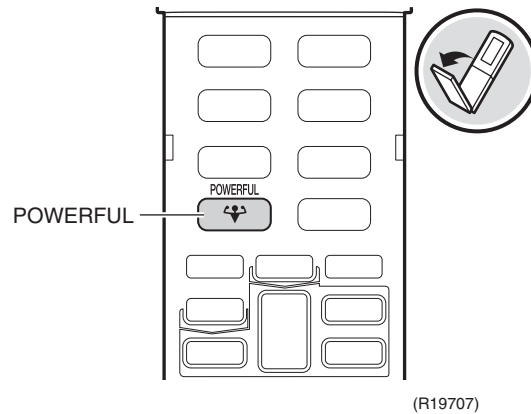

* Refer to the operation manual for details.

Features

- Operating sound becomes slightly loud.
- It is impossible to change the airflow rate, temperature, and humidity.
- The airflow rate and the compressor rotating speed are increased from the normal operation for 20 minutes. Normal operation resumes automatically in 20 minutes.
- During POWERFUL operation, fan rotates at H tap + 80 rpm.

1.12 Air Purifying and Ventilation

Operation

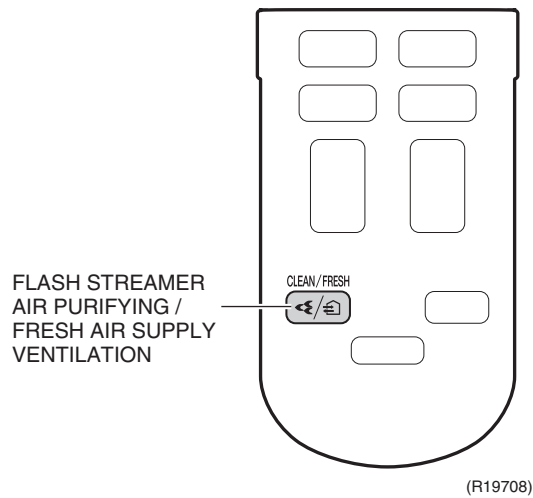

* Refer to the operation manual for details.

1.12.1 FLASH STREAMER AIR PURIFYING Operation

Features

The technology for the real air purifier is adopted for the air conditioner. The original technology FLASH STREAMER system used for Daikin's air purifiers is incorporated.

This technology realizes the air purifying exceeding far from the air purifying performance of the normal air conditioner and powerfully decomposes diesel dust, NOx, mold, virus, etc.

■ Mechanism of FLASH STREAMER Air-Purifying

The streamer unit discharges high energy electron and powerfully decomposes odour, bacteria, and hazardous chemical materials at the oxidative distraction speed of 1000 times higher than the general glow discharge.

■ Removing Formaldehyde

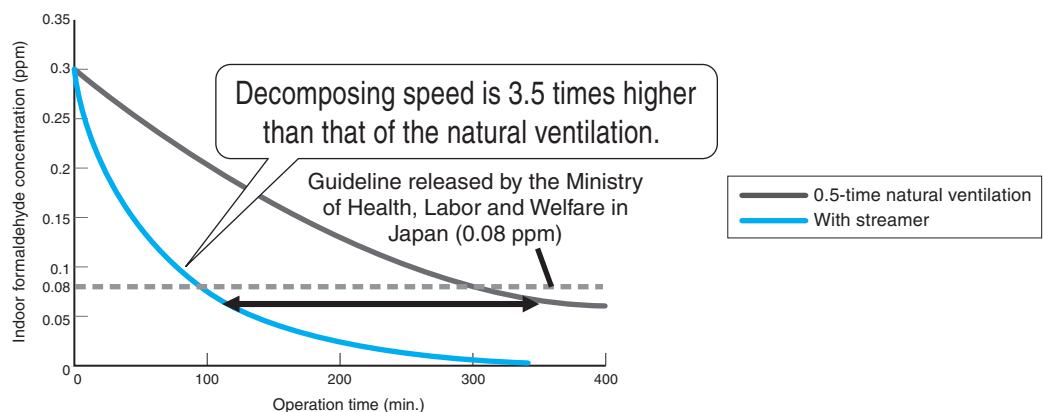

The formaldehyde concentration in the laboratory (10 m²) at 0.5-time natural ventilation and the initial concentration setting of 0.3 ppm (Daikin result) (Nozaki laboratory, Graduate Course of Health and Society System, Tohoku Bunka Gakuen University)

(R13882)

■ **Deodorising Performance of FLASH STREAMER and Titanium Apatite**

Unpleasant odour daily generated in the room such as pet odour or garbage odour is powerfully removed. Speedy deodorization: 90% or more odour has been removed in 10 minutes.

Cigarette odour of 80% or more has been removed.

Odour removal performance of FLASH STREAMER

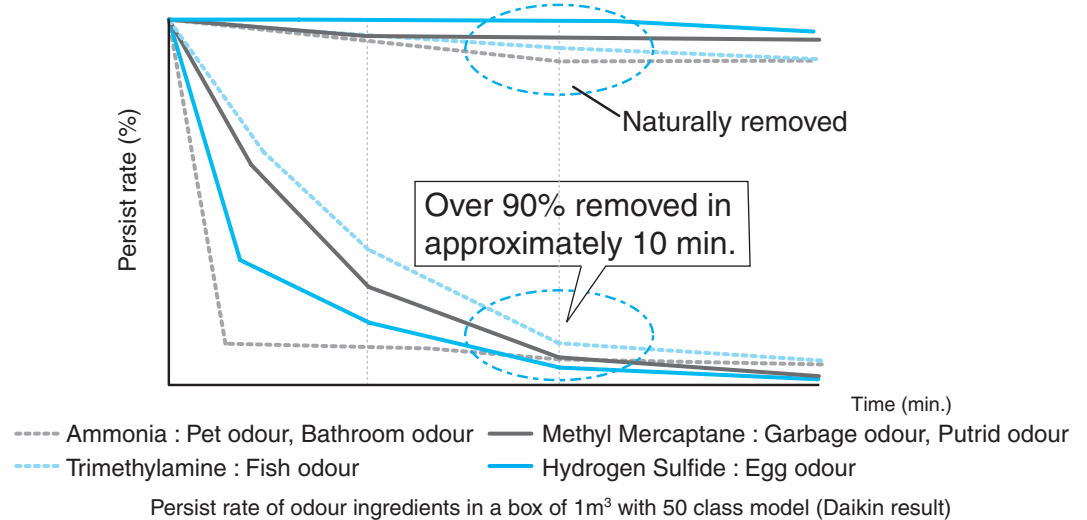

(R13883)

	Ammonia	Acetaldehyde	Acetic Acid	Cigarette Odour
Removal	90.6%	76.5%	87.2%	82.7%

1.12.2 FRESH AIR SUPPLY VENTILATION Operation

Features

The air supply ventilation system using only fresh air. Any contaminated outdoor air is purified in two stages of indoor unit and outdoor unit. Fresh air from which pollen and dust were removed is supplied into the room.

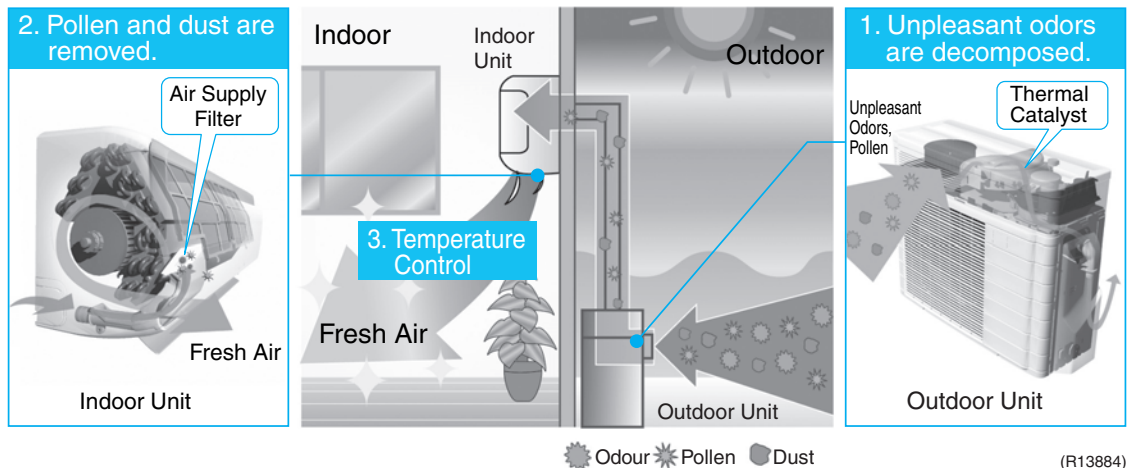

(R13884)

1. Purifying air in the outdoor unit

Thermal catalyst containing in the humidifying rotor decomposes unpleasant odour and also removes exhaust gases (NO_x, SO_x).

Manganese catalyst used to treat the automotive exhaust gas is adopted for the thermal catalyst.

2. Purifying air in the indoor unit

The air supply filter is placed at the humidifying hose outlet of the indoor unit side.

The air supply filter removes about 97% pollen and dust.

3. Controlling temperature

The fresh air passed through the air supply filter is cooled (or heated) in the indoor unit and supplied into the room.

You can keep comfortable temperature and also replace air because the ventilation is performed while temperature is controlled.

Pollen, exhaust gas and odour that could not be removed by the thermal catalyst or the air supply filter are decomposed by FLASH STREAMER.

■ Ventilation System

The ventilation type is mainly divided into two. The convenient system is supply ventilation.

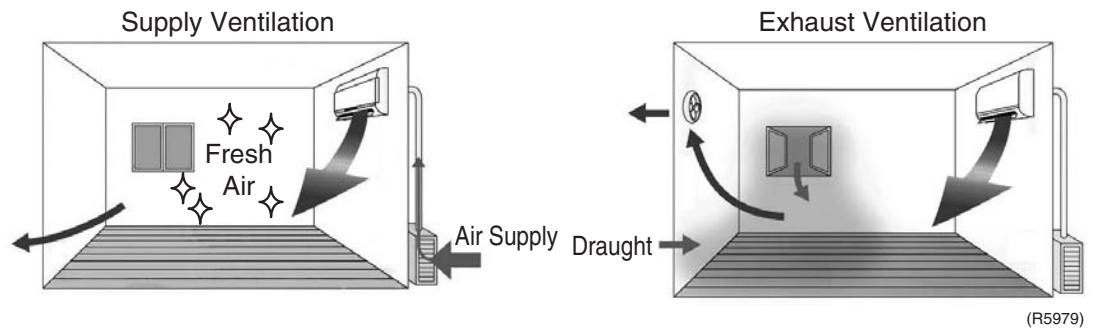

(R5979)

- | | |
|--|--|
| - Quiet because the ventilation fan is located in the outdoor unit | - Operation noise is heard because the ventilation fan is located in the room. |
| - Energy saving system due to low heat loss | - Electricity charges are high because heat loss is high. |
| - The room temperature changes little because no wind enters. | - Draught enters easily to prevent comfortable temperature from being kept. |

1.13 MOLD PROOF Operation

Outline This is an integrated naming of functions of inside drying and moisture exhaustion. Drying inside the air conditioner prevents mold and odors from growing.

Operation Automatic or manual operation can be selected.

- Automatic operation

If MOLD PROOF operation is set ON, the MOLD PROOF operation starts automatically after COOLING, SARARA DRY, or COOLING DRY operation. Operation starts depending on the amount of time the unit has been run. (approximately once every 2 weeks)
- Manual operation

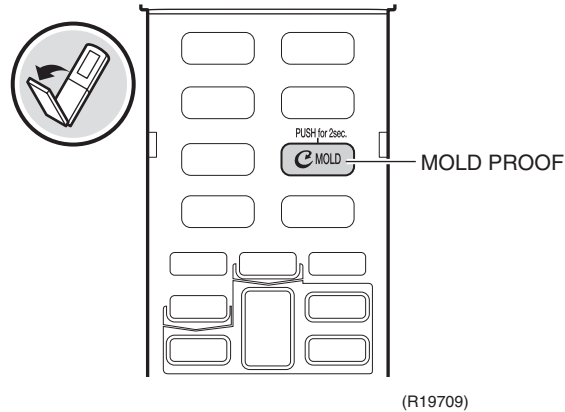

* Refer to the operation manual for details.

1.14 CLEANING FILTER Operation

Operation

- Automatic or manual operation can be selected.
- It takes about 11 minutes for cleaning.

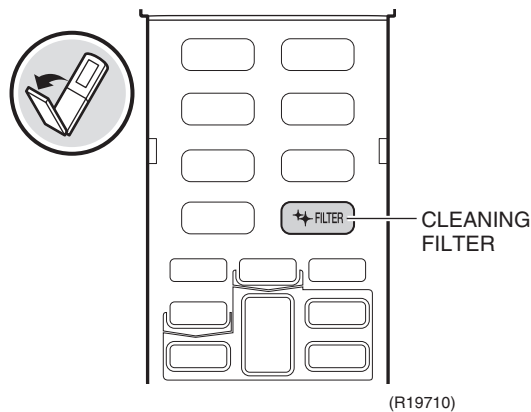

* Refer to the operation manual for details.

Detail

- CLEANING FILTER operation (manual)

The unit only accepts the CLEANING FILTER operation signal sent from the remote controller while it is not operating.

As the unit is not considered to be operating during MOLD PROOF operation, MOLD PROOF operation is stopped before switching to CLEANING FILTER operation.

When the 24 HOUR FRESH AIR SUPPLY VENTILATION is on, the unit temporarily suspends the ventilation (closes all the panels and flaps, stops the fan, stops the ventilation) and starts the CLEANING FILTER operation. 24 HOUR FRESH AIR SUPPLY VENTILATION will be restarted after the CLEANING FILTER operation is completed.

■ **CLEANING FILTER operation (automatic)**

CLEANING FILTER operation automatically starts when all the below conditions are met. When the 24 HOUR FRESH AIR SUPPLY VENTILATION is on, the unit temporarily suspends the ventilation (closes all the panels and flaps, stops the fan, stops the ventilation) and starts the CLEANING FILTER operation. 24 HOUR FRESH AIR SUPPLY VENTILATION will be restarted after the CLEANING FILTER operation is completed.

Condition	Status
CLEANING FILTER operation	ON
Operation	ON → OFF
Accumulated fan rotation time after the last CLEANING FILTER operation (including thermostat off time)	18 hours or more
Room temperature	10°C or more

■ **Forced CLEANING FILTER operation**

As the unit is required to stop for starting CLEANING FILTER operation, if the unit operates all day and night, the CLEANING FILTER operation may not start. Therefore, if the indoor fan operates for more than 24 hours, CLEANING FILTER operation starts when all the below conditions are met. When the 24 HOUR FRESH AIR SUPPLY VENTILATION is on, the unit temporarily suspends the ventilation (closes all the panels and flaps, stops the fan, stops the ventilation) and starts the CLEANING FILTER operation. 24 HOUR FRESH AIR SUPPLY VENTILATION will be restarted after the CLEANING FILTER operation is completed.

Condition	Status
CLEANING FILTER operation (automatic)	ON
Operation	Thermostat off or continuous operation of compressor for more than 30 minutes.
Indoor fan operation time	Continuous operation for more than 24 hours.
Room temperature	10°C or more

* The conditions are set to prevent starting CLEANING FILTER operation if the room temperature has not reached the target temperature. (If the compressor operates for more than 30 minutes continuously, it is considered that the room temperature has come closer to the target temperature.)



Note

CLEANING FILTER operation (manual, automatic, forced) will not start under the below conditions:

- When a filter malfunction is detected (determined by the signal from the filter position sensor).
- While the MOLD PROOF / CLEANING FILTER lamp (green) is blinking.
- When the room temperature is lower than 10°C

CLEANING FILTER operation starts after the residual operation of the humidifying fan is completed, because dust may be scattered if the CLEANING FILTER operation starts while the humidifying fan is rotating.

■ **MOLD PROOF / CLEANING FILTER lamp (green)**

MOLD PROOF / CLEANING FILTER lamp blinks after operating for 20000 hours (calculated from accumulated fan operation time) or when a brush malfunction is detected.

Brush malfunction is detected if the limit switch for the brush does not turn on/off while the brush motor is operating. (No sign of malfunction will be indicated.)

1.15 INFORMATION

- Room temperature, indoor humidity, outdoor temperature, and power consumption are displayed.
- Point the remote controller at the indoor unit for 2 seconds.

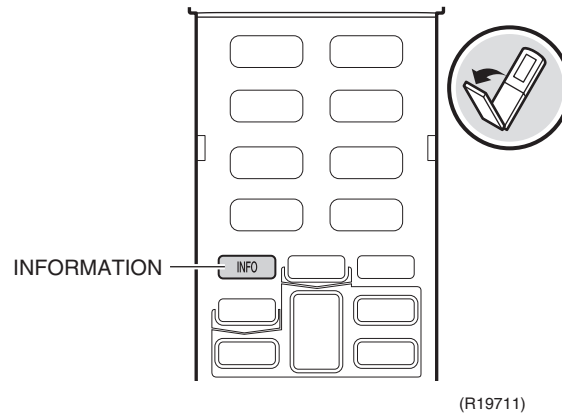

* Refer to the operation manual for details.

1.16 Brightness Setting of Indoor Unit Lamps

The brightness of the indoor unit lamps can be adjusted HIGH, LOW, or OFF.

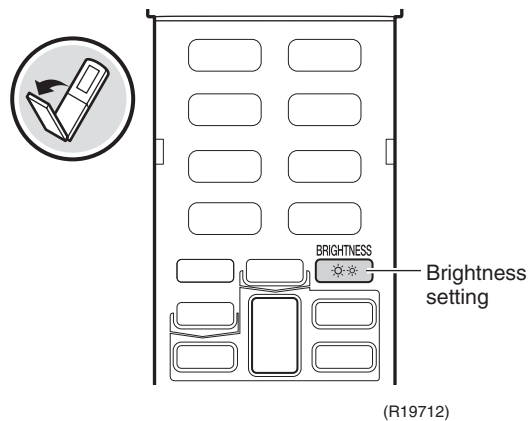

* Refer to the operation manual for details.

1.17 TIMER Operation

1.17.1 ON/OFF TIMER

Operation

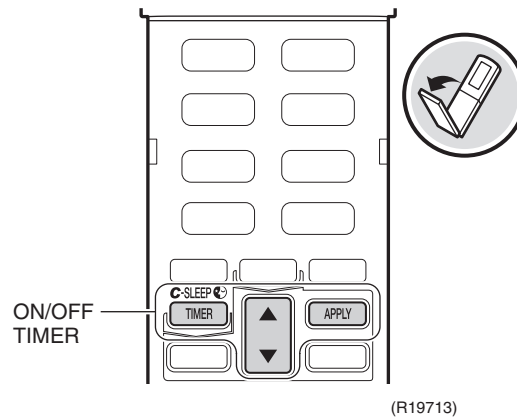

* Refer to the operation manual for details.

Features

- Time can be set in the unit of 10 minutes.
- When the 24-hour ON/OFF TIMER is set, the indication of present time disappears.
- Time is kept in memory in the next operation unless it is cancelled.
- The clock error is ± 30 seconds per month.
- 24-Hour ON/OFF TIMER or DAILY ON/OFF TIMER can be selected.



Note

ON TIMER

The microcomputer monitors the room temperature and the outdoor temperature before preset time and operation starts automatically about 1 hour before so that the room temperature becomes optimum at the preset time.

1.17.2 COUNTDOWN OFF Timer

Operation

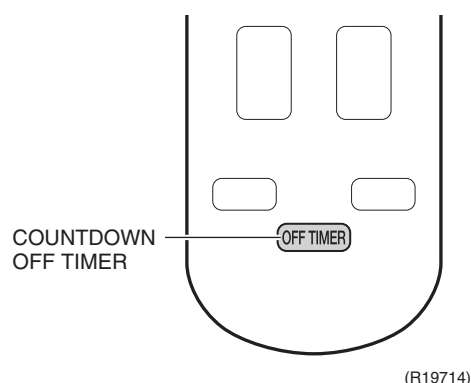

* Refer to the operation manual for details.

Features

The COUNTDOWN OFF timer can be set by simple button pressing. The operation is stopped when the set time comes. The time can be set in the unit of 0.5 hour for maximum 9.5 hours. It can be used in combination with the ON timer.

1.17.3 Combination of ON Timer and OFF Timer

ON timer and OFF timer, or ON timer and COUNTDOWN OFF timer can be used in combination.

Refer to the operation manual for details.

1.18 COMFORT SLEEP TIMER Operation

COMFORT SLEEP TIMER operation keeps the indoor temperature and humidity at suitable levels for a comfortable sleep and refreshing morning.

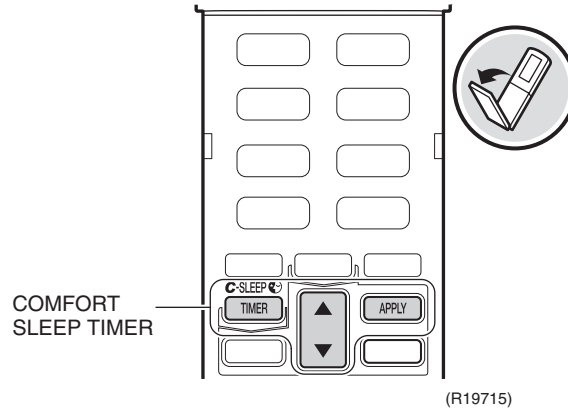

* Refer to the operation manual for details.

1.19 QUICK HEATING TIMER Operation

Outline

- QUICK HEATING TIMER operation blows warm air quickly when heating in the morning. It creates a warm zone around the indoor unit, blowing warm air at a weak airflow rate. The warm zone ranges about 1.5 m from the air conditioner.
- Preparatory heating operation preheats 30 minutes before and after the set time for QUICK HEATING TIMER, to be able to start heating operation quickly at any time.

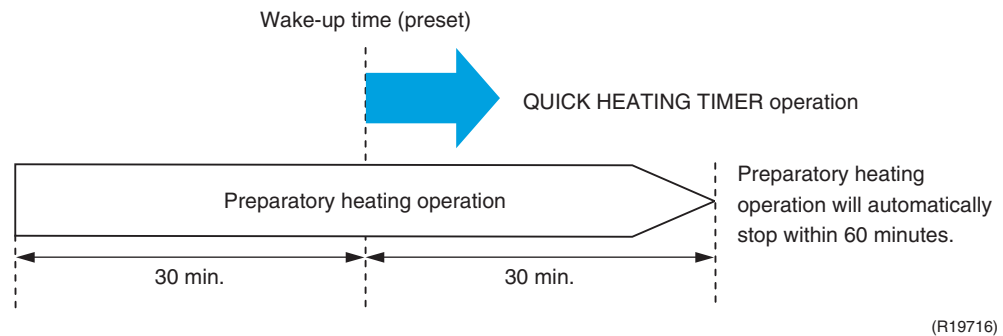

Operation

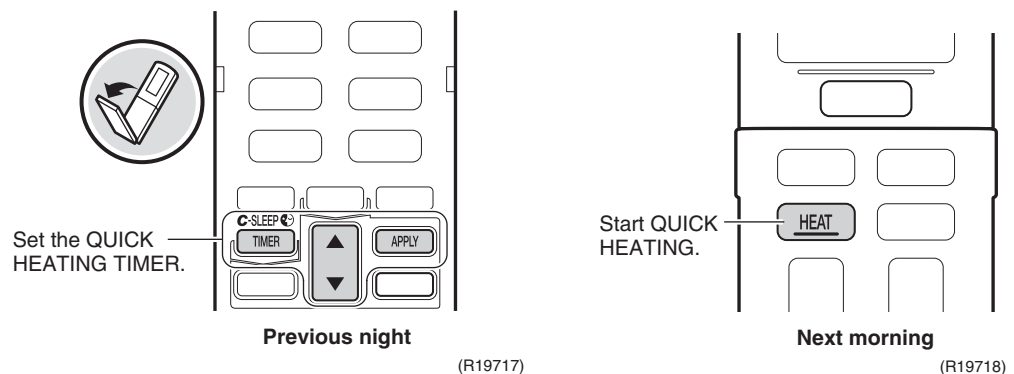

* Refer to the operation manual for details.

1.20 Other Functions

1.20.1 Hot-Start Function

In order to prevent the cold air blast that normally occurs when heating operation is started, the temperature of the indoor heat exchanger is detected, and the airflow is either stopped or significantly weakened resulting in comfortable heating.

i Note: The cold air blast is prevented using similar control when defrost control starts or when the thermostat is turned ON.

1.20.2 Signal Receiving Sign

When the indoor unit receives a signal from the remote controller, the unit emits a signal receiving sound.

1.20.3 Indoor Unit ON/OFF Button

An ON/OFF button is provided on the display of the unit.

- Press this button once to start operation. Press once again to stop it.
- This button is useful when the remote controller is missing or the battery has run out.
- The operation mode refers to the following table.

Mode	Temperature setting	Airflow rate
AUTO	25°C	Automatic

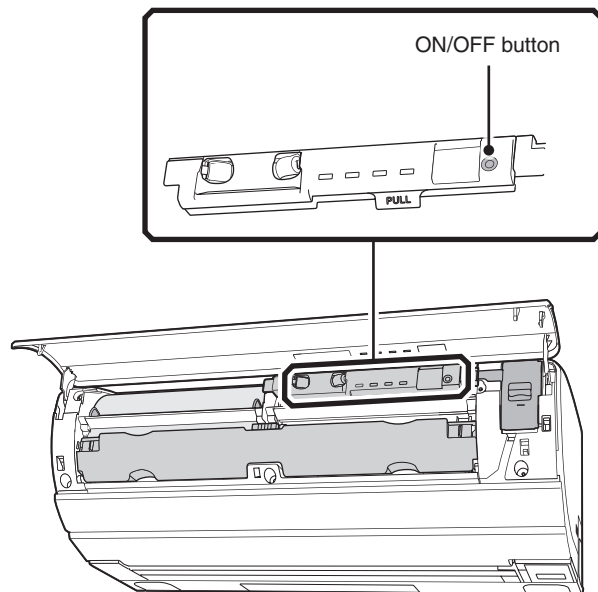

(R19719)

<Forced cooling operation>

Forced cooling operation can be started by pressing the ON/OFF button for 5 ~ 9 seconds while the unit is not operating.

Refer to page 194 for detail.

i Note: When the ON/OFF button is pressed for 10 seconds or more, the forced cooling operation is stopped.

1.20.4 Auto-restart Function

Even if a power failure (including one for just a moment) occurs during the operation, the operation restarts automatically when the power is restored in the same condition as before the power failure.

i Note: It takes 3 minutes to restart the operation because the 3-minute standby function is activated.

2. Control Specification

2.1 Frequency Control

Outline

The compressor frequency is determined according to the difference between the room thermistor temperature and the target temperature.

When the shift of the frequency is less than zero ($\Delta F < 0$) by PI control, the target frequency is used as the command frequency.

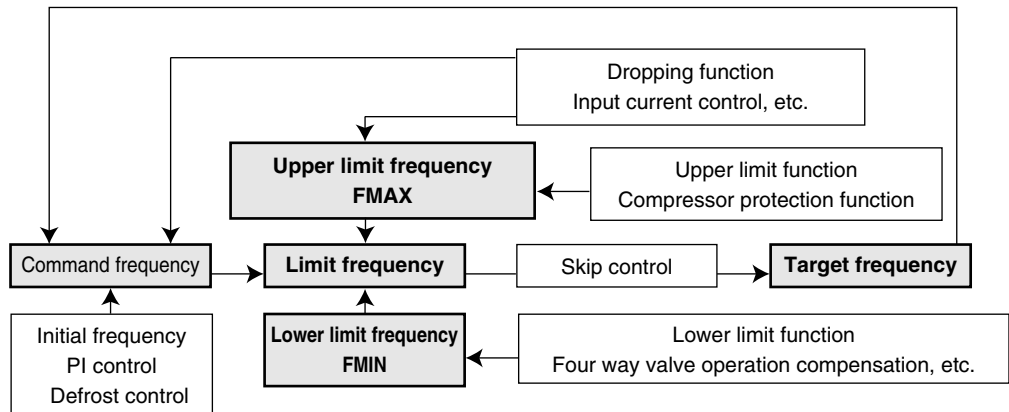

(R18023)

Detail

1. Determine command frequency

- ◆ Command frequency is determined in the following order of priority.
 1. Limiting defrost control time
 2. Forced cooling
 3. Indoor frequency command

2. Determine upper limit frequency

- ◆ The minimum value is set as an upper limit frequency among the frequency upper limits of the following functions:
Compressor protection, input current, discharge pipe temperature, heating peak-cut, freeze-up protection, defrost control.

3. Determine lower limit frequency

- ◆ The maximum value is set as a lower limit frequency among the frequency lower limits of the following functions:
Four way valve operation compensation, draught prevention, pressure difference upkeep.

4. Determine prohibited frequency

- ◆ There is a certain prohibited frequency such as a power supply frequency.

Initial Frequency

When starting the compressor, the frequency is initialised according to the ΔD value of the indoor unit.

< ΔD signal: Indoor Frequency Command>

The difference between the room thermistor temperature and the target temperature is taken as the ΔD signal and is used for frequency command

Temperature difference	ΔD signal	Temperature difference	ΔD signal	Temperature difference	ΔD signal	Temperature difference	ΔD signal
-2.0	*OFF	0	4	2.0	8	4.0	C
-1.5	1	0.5	5	2.5	9	4.5	D
-1.0	2	1.0	6	3.0	A	5.0	E
-0.5	3	1.5	7	3.5	B	5.5	F

*OFF = Thermostat OFF

PI Control**1. P control**

The ΔD value is calculated in each sampling time (15 ~ 20 seconds), and the frequency is adjusted according to its difference from the frequency previously calculated.

2. I control

If the operating frequency does not change for more than a certain fixed time, the frequency is adjusted according to the ΔD value.

When the ΔD value is low, the frequency is lowered.

When the ΔD value is high, the frequency is increased.

3. Frequency control when other controls are functioning

- ◆ When frequency is dropping;
Frequency control is carried out only when the frequency drops.
- ◆ For limiting lower limit;
Frequency control is carried out only when the frequency rises.

4. Upper and lower limit of frequency by PI control

The frequency upper and lower limits are set according to the command of the indoor unit.

When the indoor or outdoor unit quiet operation command comes from the indoor unit, the upper limit frequency is lowered than the usual setting.

2.2 Controls at Mode Changing / Start-up

2.2.1 Preheating Control

Outline

The inverter operation in open phase starts with the conditions of the preheating command from the indoor unit, the outdoor temperature, and the discharge pipe temperature. Preheating control is set to OFF by default.

Detail

Outdoor temperature $\geq 7^{\circ}\text{C}$

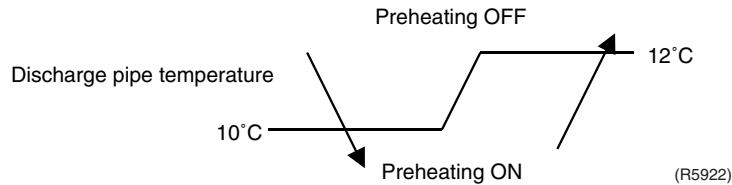

Outdoor temperature $< 7^{\circ}\text{C}$

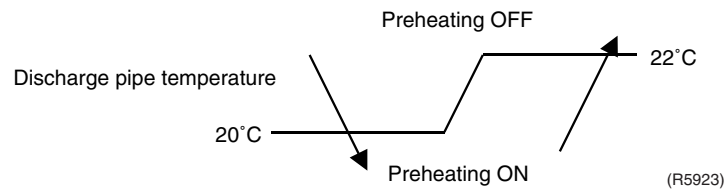

2.2.2 Four Way Valve Switching

Outline

In heating operation, current is conducted, and in cooling and defrost control, current is not conducted. In order to eliminate the switching sound as the four way valve coil switches from ON to OFF when the heating is stopped, the OFF delay switch of the four way valve is carried out.

Detail

OFF delay switch of four way valve

The four way valve coil is energised for 160 seconds after the operation is stopped.

2.2.3 Four Way Valve Operation Compensation

Outline

At the beginning of the operation as the four way valve is switched, the pressure difference to activate the four way valve is acquired when the output frequency is higher than a certain fixed frequency, for a certain fixed time.

Detail

Starting Conditions

1. When the compressor starts and the four way valve switches from OFF to ON
 2. When the four way valve switches from ON to OFF during operation
 3. When the compressor starts after resetting
 4. When the compressor starts after the fault of four way valve switching
- The lower limit of frequency keeps **A** Hz for **B** seconds with any conditions 1 through 4 above.

	Cooling	Heating
A (Hz)	46	52
B (seconds)	60	60

2.2.4 3-Minute Standby

Turning on the compressor is prohibited for 3 minutes after turning it off.
(The function is not activated when defrosting.)

2.2.5 Compressor Protection Function

When turning the compressor from OFF to ON, the upper limit of frequency is set as follows.
(The function is not activated when defrosting.)

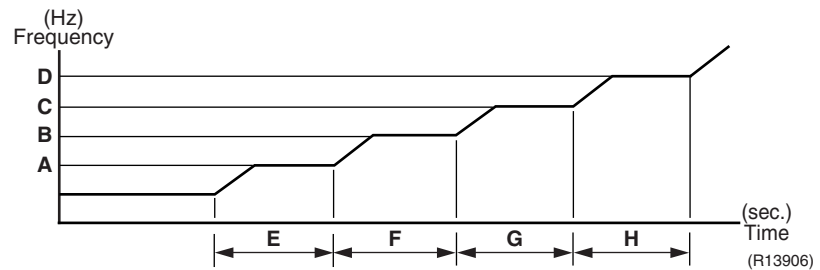

A (Hz)	52
B (Hz)	68
C (Hz)	80
D (Hz)	98
E (seconds)	120
F (seconds)	120
G (seconds)	480
H (seconds)	60

2.3 Discharge Pipe Temperature Control

Outline

The discharge pipe temperature is used as the internal temperature of the compressor. If the discharge pipe temperature rises above a certain level, the upper limit of frequency is set to keep the discharge pipe temperature from rising further.

Detail

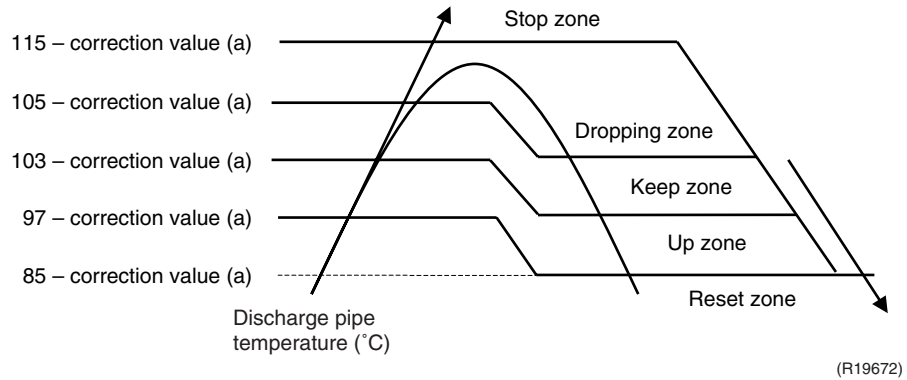

Correction value (a) = correction value by operation frequency (b)
+ correction value by outdoor temperature (c)

Correction value by operation frequency (b)

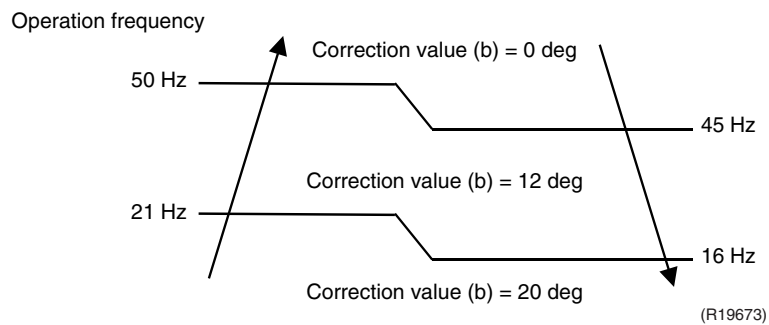

Correction value by outdoor temperature (c)

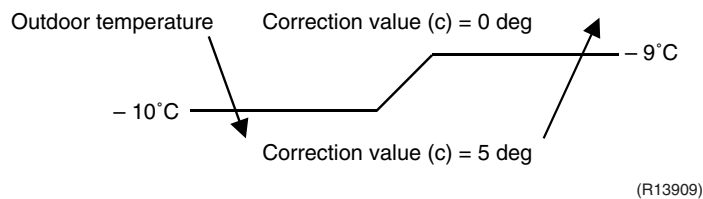

Zone	Control
Stop zone	When the temperature reaches the stop zone, the compressor stops.
Dropping zone	The upper limit of frequency decreases.
Keep zone	The upper limit of frequency is kept.
Up zone	The upper limit of frequency increases.
Reset zone	The upper limit of frequency is cancelled.

2.4 Input Current Control

Outline

The microcomputer calculates the input current while the compressor is running, and sets the frequency upper limit based on the input current. The input current control is the upper limit control of frequency and takes priority over the lower limit control of four way valve operation compensation.

Detail

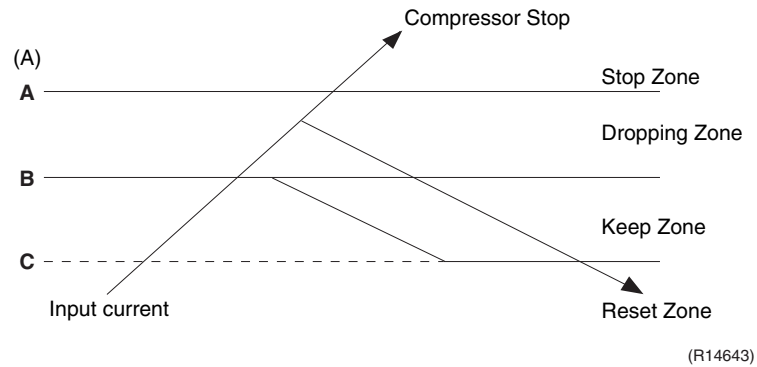

Frequency control in each zone

Stop zone

- ◆ After 5 seconds in this zone, the compressor is stopped.

Dropping zone

- ◆ The upper limit of the compressor frequency is defined as operation frequency – 2 Hz.
- ◆ After this, the output frequency is lowered by 2 Hz every second until it reaches the keep zone.

Keep zone

- ◆ The present maximum frequency goes on.

Reset zone

- ◆ Limit of the frequency is cancelled.

	25 class		35 class		50 class	
	Cooling	Heating	Cooling	Heating	Cooling	Heating
A (A)	21.0		21.0		21.0	
B (A)	10.0	9.75	10.0	12.75	10.0	14.0
C (A)	9.0	8.75	9.0	11.75	9.0	13.0

Limitation of current dropping and stop value according to the outdoor temperature

- ◆ The current drops when outdoor temperature becomes higher than a certain level (depending on the model).

2.5 Freeze-up Protection Control

During cooling operation, the signal sent from the indoor unit controls the operating frequency limitation and prevents freezing of the indoor heat exchanger. (The signal from the indoor unit is divided into zones.)

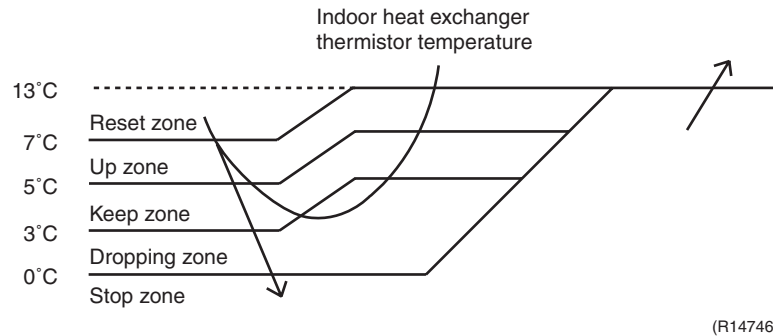

Zone	Control
Stop zone	When the temperature reaches the stop zone, the compressor stops.
Dropping zone	The upper limit of frequency decreases.
Keep zone	The upper limit of frequency is kept.
Up zone	The upper limit of frequency increases.
Reset zone	The upper limit of frequency is cancelled.

2.6 Heating Peak-cut Control

During heating operation, the indoor heat exchanger temperature determines the frequency upper limit to prevent abnormal high pressure.

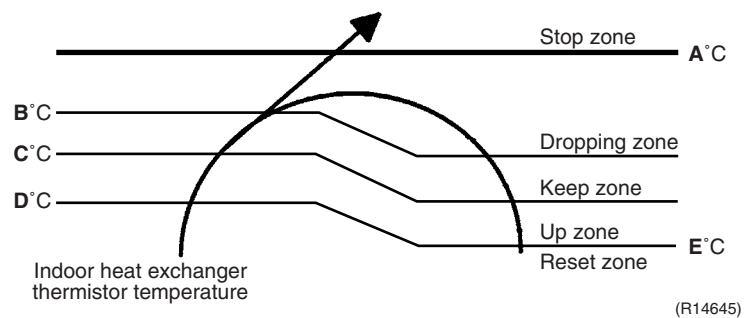

Zone	Control
Stop zone	When the temperature reaches the stop zone, the compressor stops.
Dropping zone	The upper limit of frequency decreases.
Keep zone	The upper limit of frequency is kept.
Up zone	The upper limit of frequency increases.
Reset zone	The upper limit of frequency is cancelled.

A (°C)	B (°C)	C (°C)	D (°C)	E (°C)
54.5	51.5	48.5	46.5	44.0

2.7 Draught Prevention Control (Hot-Start Function)

Outline Draught prevention control prevents cold draught when the unit is started up in heating operation.

Detail

- Draught prevention control is conducted by monitoring the indoor heat exchanger temperature and the set temperature on the remote controller (T_s). When the indoor heat exchanger temperature drops below a certain level or when the T_s exceeds 20°C , the minimum frequency of the compressor increases 4 Hz per 120 seconds.

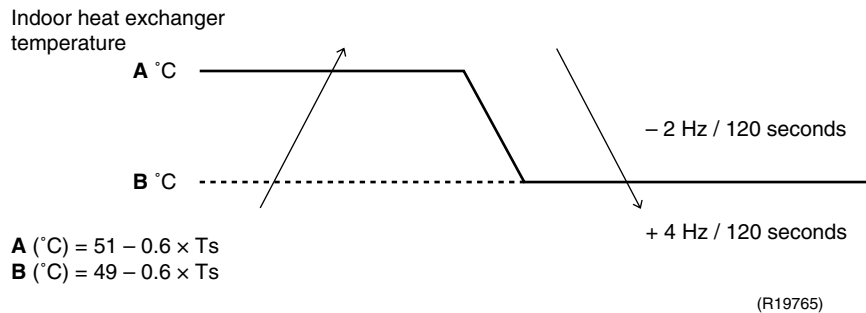

Also, the followings are controlled in order to improve energy efficiency, considering room thermistor temperature, set temperature, and airflow rate.

After starting heating operation, the unit controls the indoor heat exchanger temperatures **A** and **B** as follows, if the condition $\Delta D \leq 4$ continues for 60 minutes

* Refer to page 46 as for ΔD .

Condition	A ($^\circ\text{C}$)	B ($^\circ\text{C}$)
$27^\circ\text{C} \leq$ Room thermistor temperature	$T_s + 2^\circ\text{C}$	T_s
$20^\circ\text{C} \leq$ Room thermistor temperature < 27°C	Indoor fan speed > M tap	$T_s + 10^\circ\text{C}$
	M tap \geq Indoor fan speed > L tap	$T_s + 9^\circ\text{C}$
	L tap \geq Indoor fan speed	$T_s + 7^\circ\text{C}$
Room thermistor temperature < 20°C	$T_s + 2^\circ\text{C}$	T_s

- When the indoor heat exchanger is not hot enough, the indoor fan does not start at the set speed. The fan speed increases step by step. The limitation of the fan speed is lifted when the indoor heat exchanger temperature rises above $H^\circ\text{C}$.

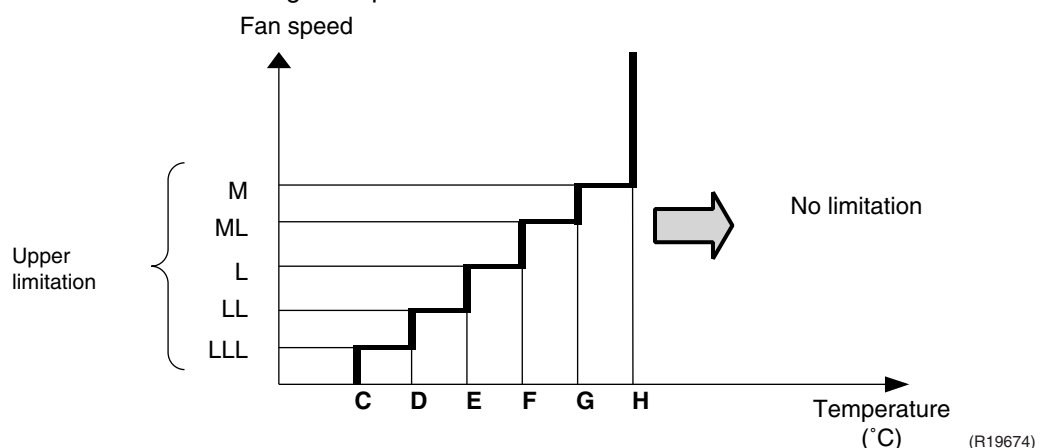

C ($^\circ\text{C}$)	D ($^\circ\text{C}$)	E ($^\circ\text{C}$)	F ($^\circ\text{C}$)	G ($^\circ\text{C}$)	H ($^\circ\text{C}$)
10	25	35	37	38	39

2.8 Dew Prevention Control

Outline

Cooling the air around us means that the air is dehumidified (condensation of water on the indoor heat exchanger). But because the air is cooled down, less moisture can present in the air and as a consequence the relative humidity of the air rises. When the relative humidity of the outlet air nears 100%, water may be blown out. To prevent this from happening, the unit changes, its target evaporating temperature and the frequency of the compressor under certain circumstances. Normally speaking, even under these conditions (dew prevention safety active), the room should still be cooled down, only slower. Of course, if the capacity of the indoor unit is small in comparison to the heat load, this is not the case and capacity shortage complaints may follow.

Detail

- When the indoor heat exchanger temperature is lower than the target temperature of the indoor heat exchanger, the compressor frequency decreases by 2 Hz in every minute.
- The target temperature of the indoor heat exchanger is calculated with the room temperature and the indoor humidity.

2.9 Outdoor Fan Control

1. Fan OFF delay when stopped

The outdoor fan is turned OFF 70 seconds after the compressor stops.

2. Fan ON control to cool down the electrical box

The outdoor fan is turned ON when the electrical box temperature is high while the compressor is OFF.

3. Fan OFF control during defrosting

The outdoor fan is turned OFF during defrosting.

4. Fan ON/OFF control when operation starts / stops

The outdoor fan is turned ON when the operation starts. The outdoor fan is turned OFF when the operation stops.

5. Fan speed control during cooling operation

The rotation speed of the outdoor fan is fixed. However, when the outdoor temperature is low, the unit may lower the fan rotation frequency to set a pressure difference. Also, when the outdoor temperature is high, the unit may raise the fan rotation frequency to cool the electrical box.

Class	Cooling
25 class	710 rpm
35 class	780 rpm
50 class	860 rpm

6. Fan speed control during heating operation

The rotation speed of the outdoor fan is fixed. However, when the outdoor temperature is high, the unit may lower the fan rotation frequency to set a pressure difference.

Class	Heating
25 class	700 rpm
35 class	780 rpm
50 class	820 rpm

2.10 Defrost Control

Outline

Defrosting is carried out by the cooling cycle (reverse cycle). The defrosting time or outdoor heat exchanger temperature must be more than a certain value to finish defrosting.

Detail

Conditions for Starting Defrost

- The starting conditions are determined with the outdoor temperature and the outdoor heat exchanger temperature.
- The system is in heating operation.
- The compressor operates for 6 minutes.
- More than 25 minutes of accumulated time have passed since the start of the operation, or ending the previous defrosting.

Conditions for Cancelling Defrost

The judgement is made with the outdoor heat exchanger temperature. (6 ~ 30°C)

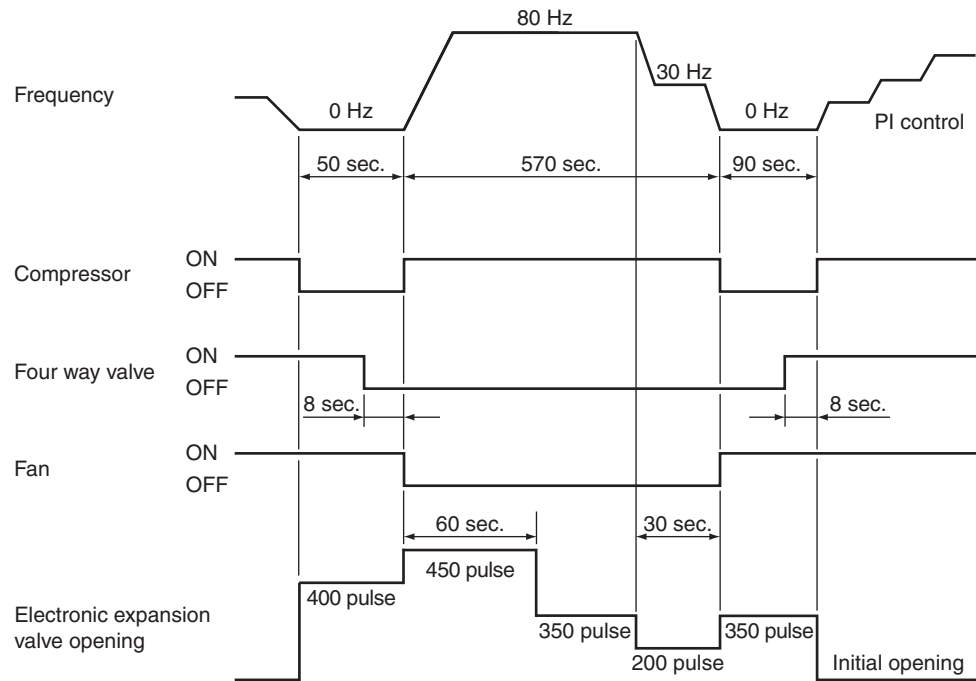

(R19675)

2.11 Electronic Expansion Valve Control

Outline

The following items are included in the electronic expansion valve control.

Electronic expansion valve is fully closed

1. Electronic expansion valve is fully closed when turning on the power.
2. Pressure equalising control

Open Control

1. Electronic expansion valve control when starting operation
2. Electronic expansion valve control when the frequency changes
3. Electronic expansion valve control for defrosting
4. Electronic expansion valve control when the discharge pipe temperature is abnormally high
5. Electronic expansion valve control when the discharge pipe thermistor is disconnected

Feedback Control

Target discharge pipe temperature control

Detail

The followings are the examples of electronic expansion valve control which function in each operation mode.

Operation mode	Main control	Secondary control	
		Control when the frequency changes	High discharge pipe temperature control
Power ON	Power initialising control	–	–
Cooling operation	Starting control	–	●
	Target discharge pipe temperature control	●	●
Stop	Pressure equalising control	–	–
Heating operation	Starting control	–	●
	Target discharge pipe temperature control	●	●
Stop	Pressure equalising control	–	–
Operation with discharge pipe thermistor disconnected	Starting control	–	●
	Target discharge pipe temperature control	–	–
Stop	Pressure equalising control	–	–

● : Available
– : Not available

2.11.1 Fully Closing with Power ON

The electronic expansion valve is initialised when turning on the power. The opening position is set and the pressure is equalised.

2.11.2 Pressure Equalising Control

When the compressor is stopped, the pressure equalising control is activated. The electronic expansion valve opens, and develops the pressure equalisation.

2.11.3 Opening Limit Control

The maximum and minimum opening of the electronic expansion valve are limited.

Maximum opening (pulse)	470
Minimum opening (pulse)	10

The electronic expansion valve is fully closed when cooling operation stops, and is opened at a fixed degree during defrosting.

2.11.4 Starting Operation Control

The electronic expansion valve opening is controlled when the operation starts, and preventing superheating or liquid compression.

2.11.5 Control when the Frequency Changes

When the target discharge pipe temperature control is active, if the target frequency changes to a specified value in a certain time period, the target discharge pipe temperature control is cancelled and the target opening of the electronic expansion valve is changed according to the frequency shift.

2.11.6 High Discharge Pipe Temperature Control

When the compressor is operating, if the discharge pipe temperature exceeds a certain value, the electronic expansion valve opens and the refrigerant runs to the low pressure side. This procedure lowers the discharge pipe temperature.

2.11.7 Discharge Pipe Thermistor Disconnection Control

Outline

The disconnection of the discharge pipe thermistor is detected by comparing the discharge pipe temperature with the condensation temperature. If the discharge pipe thermistor is disconnected, the electronic expansion valve opens according to the outdoor temperature and the operation frequency, operates for a specified time, and then stops.

After 3 minutes, the operation restarts and checks if the discharge pipe thermistor is disconnected. If the discharge pipe thermistor is disconnected, the system stops after operating for a specified time.

If the disconnection is detected repeatedly, the system is shut down. When the compressor runs for 60 minutes without any error, the error counter is reset.

Detail

When the starting control (360 seconds) finishes, the detection timer for disconnection of the discharge pipe thermistor (720 seconds) starts. When the timer is over, the following adjustment is made.

1. When the operation mode is cooling
When the following condition is fulfilled, the discharge pipe thermistor disconnection is ascertained.
Discharge pipe temperature + 6°C < outdoor heat exchanger temperature
2. When the operation mode is heating
When the following condition is fulfilled, the discharge pipe thermistor disconnection is ascertained.
Discharge pipe temperature + 6°C < indoor heat exchanger temperature

When the thermistor is disconnected

When the disconnection is ascertained, the compressor continues operation for 9 minutes and then stops.

When the compressor stops repeatedly, the system is shut down.

2.11.8 Target Discharge Pipe Temperature Control

The target discharge pipe temperature is obtained from the indoor and outdoor heat exchanger temperature, and the electronic expansion valve opening is adjusted so that the actual discharge pipe temperature becomes close to the target discharge pipe temperature. (Indirect SH (superheating) control using the discharge pipe temperature)

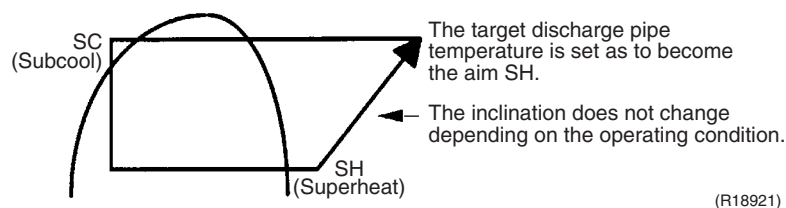

The electronic expansion valve opening and the target discharge pipe temperature are checked every 20 seconds. The opening degree of the electronic expansion valve is adjusted by the followings.

- ◆ Target discharge pipe temperature
- ◆ Actual discharge pipe temperature
- ◆ Previous discharge pipe temperature

Part 5 Installation / Operation Manual



1. Installation Manual	59
2. Operation Manual.....	78

1. Installation Manual

Safety Precautions



	Read the precautions in this manual carefully before operating the unit.		This appliance is filled with R32.
---	--	---	------------------------------------

- The precautions described herein are classified as WARNING and CAUTION. They both contain important information regarding safety. Be sure to observe all precautions without fail.
- Meaning of WARNING and CAUTION notices

⚠ WARNING..... Failure to follow these instructions properly may result in personal injury or loss of life.



⚠ CAUTION..... Failure to observe these instructions properly may result in property damage or personal injury, which may be serious depending on the circumstances.

- The safety marks shown in this manual have the following meanings:

	Be sure to follow the instructions.		Be sure to establish an earth connection.		Never attempt.
---	-------------------------------------	---	---	--	----------------

- After completing installation, conduct a trial operation to check for faults and explain to the customer how to operate the air conditioner and take care of it with the aid of the operation manual.

⚠ WARNING

- **Ask your dealer or qualified personnel to carry out installation work.**
Do not attempt to install the air conditioner yourself. Improper installation may result in water leakage, electric shocks or fire.
- **Install the air conditioner in accordance with the instructions in this installation manual.**
Improper installation may result in water leakage, electric shocks or fire.
- **Be sure to use only the specified accessories and parts for installation work.**
Failure to use the specified parts may result in the unit falling, water leakage, electric shocks or fire.
- **Install the air conditioner on a foundation strong enough to withstand the weight of the unit.**
A foundation of insufficient strength may result in the equipment falling and causing injury.
- **Electrical work must be performed in accordance with relevant local and national regulations and with instructions in this installation manual. Be sure to use a dedicated power supply circuit only.**
Insufficiency of power circuit capacity and improper workmanship may result in electric shocks or fire.
- **Use a cable of suitable length.**
Do not use tapped wires or an extension lead, as this may cause overheating, electric shocks or fire.
- **Make sure that all wiring is secured, the specified wires are used, and that there is no strain on the terminal connections or wires.**
Improper connections or securing of wires may result in abnormal heat build-up or fire.
- **When wiring the power supply and connecting the wiring between the indoor and outdoor units, position the wires so that the control box lid can be securely fastened.**
Improper positioning of the control box lid may result in electric shocks, fire or over heating terminals.
- **If refrigerant gas leaks during installation, ventilate the area immediately.** 
Toxic gas may be produced if the refrigerant comes into contact with fire.
- **After completing installation, check for refrigerant gas leakage.** 
Toxic gas may be produced if the refrigerant gas leaks into the room and comes into contact with a source of fire, such as a fan heater, stove or cooker.
- **When installing or relocating the air conditioner, be sure to bleed the refrigerant circuit to ensure it is free of air, and use only the specified refrigerant (R32).**
The presence of air or other foreign matter in the refrigerant circuit causes abnormal pressure rise, which may result in equipment damage and even injury.
- **During installation, attach the refrigerant piping securely before running the compressor.**
If the refrigerant pipes are not attached and the stop valve is open when the compressor is run, air will be sucked in, causing abnormal pressure in the refrigeration cycle, which may result in equipment damage and even injury.
- **During pump-down, stop the compressor before removing the refrigerant piping.**
If the compressor is still running and the stop valve is open during pump-down, air will be sucked in when the refrigerant piping is removed, causing abnormal pressure in the refrigeration cycle, which may result in equipment damage and even injury.

Safety Precautions

WARNING

- **Be sure to earth the air conditioner.**
Do not earth the unit to a utility pipe, lightning conductor or telephone earth lead. Imperfect earthing may result in electric shocks. 
- **Be sure to install an earth leakage circuit breaker.**
Failure to install an earth leakage circuit breaker may result in electric shocks or fire.
- **Do not use means to accelerate the defrosting process or to clean, other than those recommended by the manufacturer.**
- **The appliance must be stored in a room without continuously operating ignition sources (for example: open flames, an operating gas appliance or an operating electric heater).**
- **Do not pierce or burn.**
- **Be aware that refrigerants may not contain an odour.**
- **The appliance must be installed, operated and stored in a room with a floor area larger than 1.8m².**
- **Comply with national gas regulations.**

CAUTION

- **Do not install the air conditioner at any place where there is a danger of flammable gas leakage.**
In the event of a gas leakage, build-up of gas near the air conditioner may cause a fire to break out. 
- **While following the instructions in this installation manual, install drain piping to ensure proper drainage and insulate piping to prevent condensation.**
Improper drain piping may result in indoor water leakage and property damage.
- **Tighten the flare nut according to the specified method such as with a torque wrench.**
If the flare nut is too tight, it may crack after prolonged use, causing refrigerant leakage.
- **Take adequate steps to prevent the outdoor unit being used as a shelter by small animals.**
Small animals making contact with electrical parts can cause malfunctions, smoke or fire. Please instruct the customer to keep the area around the unit clean.
- **The temperature of refrigerant circuit will be high, please keep the inter-unit wire away from copper pipes that are not thermally insulated.**
- **Only qualified personnel can handle, fill, purge and dispose of the refrigerant.**

N002

■ Important information regarding the refrigerant used

This product contains fluorinated greenhouse gases covered by the Kyoto Protocol. Do not vent gases into the atmosphere.

Refrigerant type: **R32**

GWP⁽¹⁾ value: **550** *







⁽¹⁾GWP = global warming potential

The refrigerant quantity is indicated on the unit name plate.

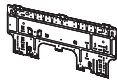



* This value is based on F gas regulation (824/2006).

Accessories

Indoor unit

<p>(A) Mounting plate</p> 	1	<p>(B) Air-purifying and deodorising filter</p> 	1	<p>(C) Indoor unit fixing screws (M4 x 12L)</p> 	3
<p>(D) Wireless remote controller</p> 	1	<p>(E) Remote controller holder</p> 	1	<p>(F) Dry batteries AA.LR6 (alkaline)</p> 	2

Outdoor unit

<p>(G) Humidifying hose (8m)</p> 	1	<p>(H) Drain socket</p> 	1	<p>(J) Joint</p> 	1
<p>(K) Binding bands</p> 	3	<p>(L) Operation manual</p>	1	<p>(M) Installation manual</p>	1

- The standard humidifying hose is 8m.
- The extension hose (option) is 2m (KPMH974A402).
- An humidifying hose of 10m (KPMH974A42) is also available as an option to replace the standard one (8m).

Choosing an Installation Site

Before choosing the installation site, obtain user approval.

1. Indoor unit

- The indoor unit should be sited in a place where:
 - 1) the restrictions on installation specified in “Indoor/Outdoor Unit Installation Drawings” on page 6 are met,
 - 2) both air inlet and outlet are free of obstructions,
 - 3) the unit is not in the path of direct sunlight,
 - 4) the unit is away from the source of heat or steam,
 - 5) there is no source of machine oil vapour (this may shorten indoor unit life),
 - 6) cool/warm air is circulated throughout the room,
 - 7) the unit is away from electronic ignition type fluorescent lamps (inverter or rapid start type) as they may shorten the remote control range,
 - 8) the unit is at least 1m away from any television or radio set (unit may cause interference with the picture or sound),
 - 9) space allows for the moving range of the flap in operation above curtain rails or other objects,
 - If (**) is 70mm or more, allow for 15mm of space from the indoor unit.
 - If it is less than 15mm, this can affect the opening and closing of the shutter (bottom air inlet).
 - 10) a height of 2.5m or more is allowed for installation,
 - 11) no laundry equipment is located nearby.

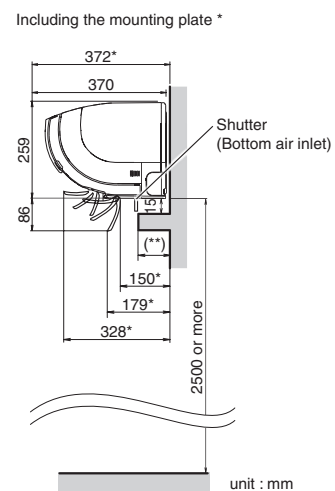

Choosing an Installation Site

2. Wireless remote controller (When mounting on a wall etc.)

- Turn on all the fluorescent lamps in the room, if any, and find the site where remote control signals are properly received by the indoor unit (within 7m).
- Select a place where the remote controller is not hit by direct sunlight. (Selecting a place where direct sunlight hits the remote controller makes it difficult for the remote controller to receive the signal from the indoor unit.)

3. Outdoor unit

- The outdoor unit should be sited in a place where:
 - 1) the restrictions on installation specified in "Indoor/Outdoor Unit Installation Drawings" on page 6 are met,
 - 2) the ground is solid enough to bear the weight and vibration of the unit and where the operating sound will not be amplified,
 - 3) the hot air discharged from the unit or the operating sound will not cause a nuisance to the neighbors of the user,
 - 4) there is no bedroom or the like nearby, so that the operating sound will cause no trouble,
 - 5) there are sufficient spaces for carrying the unit into and out of the site,
 - 6) both air inlet and outlet have clear paths of air (they should be free of snow in snowy districts),
 - 7) there is no fear of inflammable gas leakage in a nearby place,
 - 8) units, power cords and inter-unit wires at least 3m away from television and radio sets (This is to prevent interference to images and sounds. Noises may be heard even if they are more than 3m away depending on radio wave conditions),
 - 9) the unit is not directly exposed to salt, sulfidized gases, or machine oil vapour (they may shorten outdoor unit life),
 - 10) nothing which must be kept away from moisture is under the unit since drain flows out of the outdoor unit,
 - 11) the air is clean, and there are no sources of unpleasant odours close by.

NOTE

Cannot be installed hanging from ceiling or stacked.

⚠ CAUTION

When operating the air conditioner in a low outdoor ambient temperature, be sure to follow the instructions described below.

- To prevent exposure to wind, install the outdoor unit with its suction side facing the wall.
- Never install the outdoor unit at a site where the suction side may be exposed directly to wind.
- To prevent exposure to wind, it is recommended to install a baffle plate on the air discharge side of the outdoor unit.
- In heavy snowfall areas, select an installation site where the snow will not affect the unit.

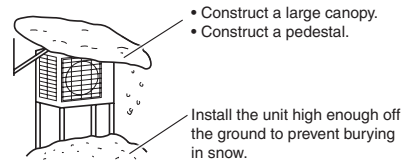

Precautions for humidifying hose installation work

- When embedding ㊟ humidifying hose:
Cannot be installed to the existing embedded piping. Embedding work is separately necessary.
- The length of the ㊟ humidifying hose is marked on the hose packing material.
 - 1) Use an extension hose (option) when extending the ㊟ humidifying hose.
 - 2) The length of the ㊟ humidifying hose needs to be set to ensure humidifying capacity. Cut off any excess hose.
Use the remote controller to set the hose length. (Refer to "9. Setting the humidifying hose length" on page 16.)
- If the ㊟ humidifying hose needs to be cut to be laid, cut it, lay it, and connect it using the ㊵ joint included with the outdoor unit or an elbow (field supply). When doing this, wrap it to prevent air leaks with the ㊶ binding band included with the outdoor unit. (Refer to "4-2 Connecting the cut humidifying hoses" on page 8.)
- When laying the ㊟ humidifying hose inside the wall, block the ends of the ㊟ humidifying hose with tape or the like to prevent water or anything else from entering it until it is connected to the indoor unit and outdoor unit ducts.

Indoor/Outdoor Unit Installation Drawings

How to attach the indoor unit

- Using the Δ marks (3 locations) on top of the indoor unit, attach the (A) mounting plate hooks onto the indoor unit.
- Attach the tabs on the bottom frame onto the (A) mounting plate. If the tabs are not hooked onto the plate, remove the front grille to hook them. (Check to see if the tabs are hooked securely.)

How to remove the indoor unit

Push up the mark part on the bottom of the front grille (bottom), discharge the tabs, and then remove the unit while lifting it up.

Max. allowable piping length	10m
Min. allowable piping length*	1.5m
Max. allowable piping height	8m
Gas pipe	O.D. 9.5mm
Liquid pipe	O.D. 6.4mm
Max. allowable refrigerant charge amount **	1.34kg

Refrigerant piping must be kept to a minimum.
 * The suggested shortest piping length is 1.5m, in order to avoid noise from the outdoor unit and vibration. (Mechanical noise and vibration may occur depending on how the unit is installed and the environment in which it is used.)
 ** Do not additionally charge refrigerant.

50mm or more from walls (on both sides)
 • If the wall on one side is sufficiently away, the distance from the other wall can be 20mm at the minimum.

Install the hose with a downward slope.

Do not bend the (G) humidifying hose more than 90°.

Cut thermal insulation pipe to an appropriate length and wrap it with tape, making sure that no gap is left in the insulation pipe's cut line.

Refrigerant piping must be protected from physical damage. Install a plastic cover or equivalent.

Allow 300mm of work space below the ceiling surface.

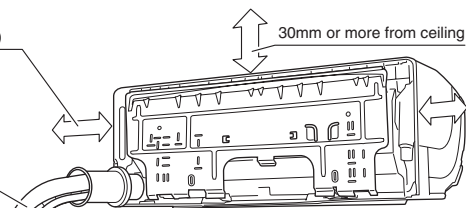

Do not install the trap to the (G) humidifying hose as much as possible.

The flare connection should be installed outdoors.

(G) Humidifying hose
 If it is difficult to lay the (G) humidifying hose, cut it, lay it, and connect it using the (J) joint included with the outdoor unit or an elbow (field supply).

CAUTION
 * Set the piping length from 1.5m to 10m.

Wrap the insulation pipe with the finishing tape from bottom to top.

(D) Wireless remote controller
 Hook
 (E) Remote controller holder
 Screws (field supply: M3 x 20L)
 Set the (F) batteries.
 Before screwing the (E) remote controller holder to the wall, make sure that control signals are properly received by indoor unit.

250mm from wall

Allow space for piping and electrical servicing.

Connect the flare from the indoor unit side.

In sites with poor drainage, use block bases for outdoor unit. Adjust foot height until the unit is leveled. Otherwise, water leakage or pooling of water may occur.

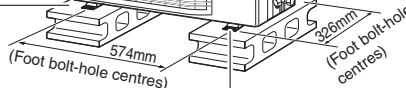

Where there is a danger of the unit falling, use foot bolts, or wires.

Stop valve cover

How to remove the stop valve cover.

- Remove the screw on the stop valve cover.
- Slide the cover downward to remove it.

How to attach the stop valve cover.

- Insert the upper part of the stop valve cover into the outdoor unit.
- Tighten the screws.

Indoor Unit Installation

1. Installing the mounting plate

- The (A) mounting plate is located at the back of the indoor unit. Remove a screw.
- The (A) mounting plate should be installed on a wall which can support the weight of the indoor unit.
 - Temporarily secure the (A) mounting plate to the wall, make sure that the plate is completely level, and mark the boring points on the wall.
 - Secure the (A) mounting plate to the wall with screws.

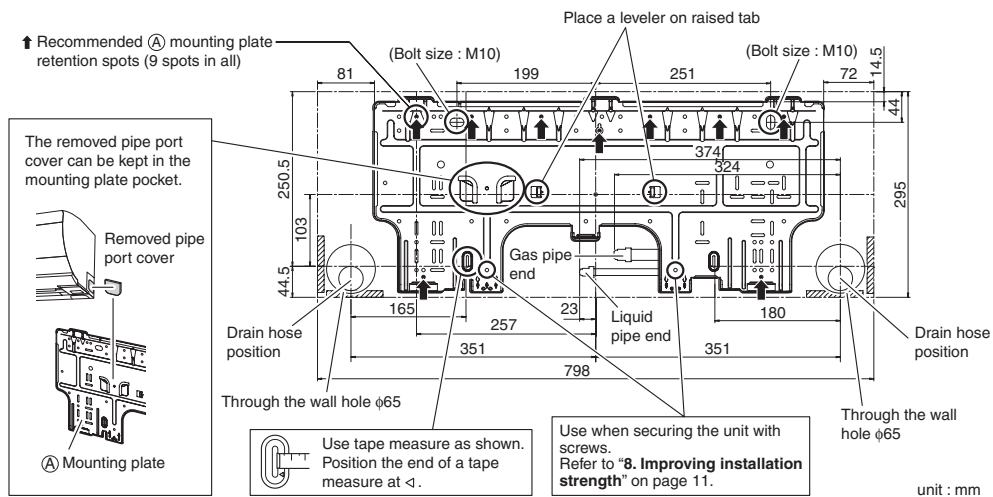

2. Boring a wall hole and installing wall embedded pipe

- For walls containing metal frame or metal board, be sure to use a wall embedded pipe and wall hole cover in the feed-through hole to prevent possible heat, electrical shock, or fire.
- Be sure to caulk the gaps around the pipes with caulking material to prevent water leakage.
 - Bore a feed-through hole of 65mm in the wall so it has a down slope toward the outside.
 - Insert a wall embedded pipe into the hole.
 - Insert a wall hole cover into wall pipe.
 - After completing refrigerant piping, wiring, and drain piping, caulk pipe hole gap with putty.

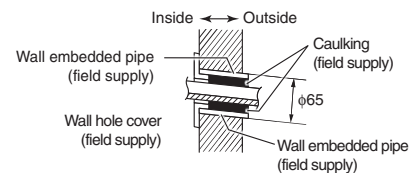

3. Installing inter-unit wiring

- Remove the screw cover and then the service lid.
- Pull out the inter-unit wire from the back of the indoor unit to the front. It is easier to pull out if bending up the wire edge in advance.
- To connect the inter-unit wire after hooking the unit onto the (A) mounting plate, connect the inter-unit wire as shown in the figure.

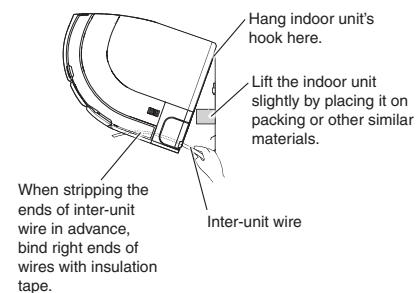
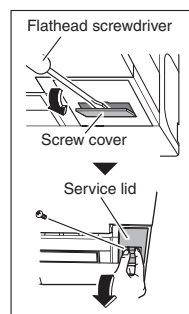

4. Humidifying hose installation work

4-1 Connecting to the indoor unit

- Connect the cuff side of the ㉔ humidifying hose to the indoor unit duct.

It is easier to connect the hose with the front grille removed.

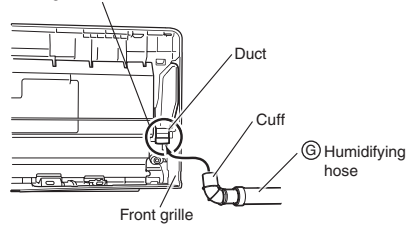

• Left-side piping

Insert as far as possible so that there are no gaps.

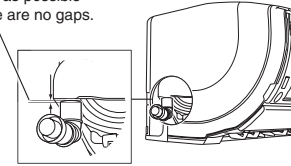

To pull out the ㉔ humidifying hose to the right side, turn the cuff 180° from the position shown in the above illustration.

• Left-bottom piping

Cut the cuff at this point.

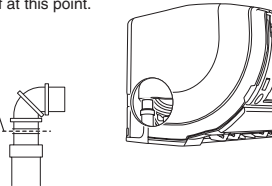

• Left-back piping

Cut the skirt section of the cuff with scissors (cut the dotted line section).

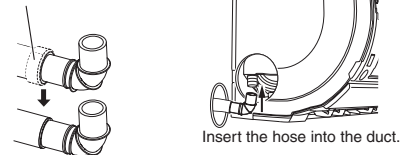

Insert the hose into the duct.

4-2 Connecting the cut humidifying hoses

- When installing the cut ㉔ humidifying hoses, follow the instructions below.

Insert each ㉔ humidifying hose to the rim of the ㉑ joint or an elbow (field supply) so that there are no gaps.



Apply the ㉒ binding bands at 10mm from the rim of the ㉑ joint or an elbow (field supply) to prevent the ㉔ humidifying hose from coming off.

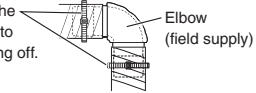

- Use not more than 1 elbow to ensure humidifying capacity.

4-3 How to replace the drain plug and drain hose

• Replacing onto the left side

- 1) Remove the insulation fixing screw on the right to remove the drain hose.
- 2) Reattach the insulation fixing screw on the right as it was. Forgetting to attach this may cause water leakages.
- 3) Remove the drain plug on the left side and attach it to the right side.
- 4) Insert the drain hose and tighten with included ㉓ indoor unit fixing screw.

How to set drain plug

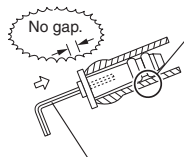

Do not apply lubricating oil (refrigerant oil) to the drain plug when inserting it. The application of lubrication oil to the drain plug will deteriorate the plug to cause drain leakage from the plug.

Insert a hexagon wrench (4mm).

Drain hose attachment position

The drain hose is on the back of the unit.

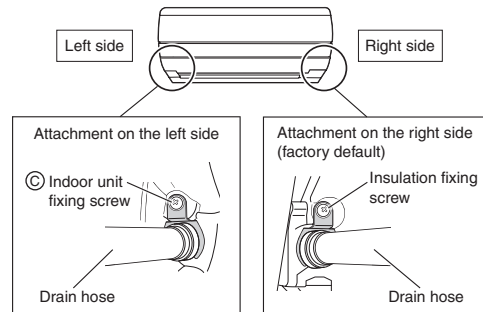

⚠ CAUTION

Use caution not to deform the cuff while installing the humidifying hose. Using a deformed cuff may cause a clapping sound.

Indoor Unit Installation

5. Laying piping, hoses, and wiring

- Lay the pipes, drain hose and ㉔ humidifying hose according to the orientation of the piping coming out of the unit, as shown in the figure.
- Make sure the drain hose is sloped downward.
- Wrap the pipes, drain hose and ㉔ humidifying hose together using insulation tape.

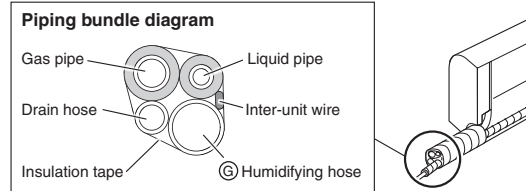

5-1 Right-side, right-back, or right-bottom piping

• Right-side piping

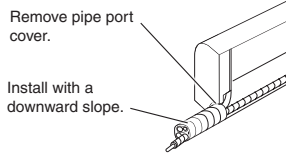

• Right-back piping

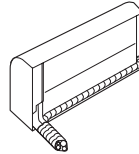

• Right-bottom piping

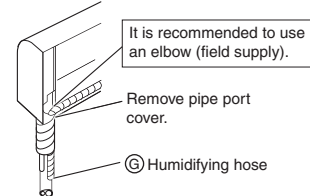

- 1) Wrap the pipes, hose and inter-unit wire using insulation tape as shown in the piping bundle diagram.
- 2) Put all the pipes through the through-hole in the wall and hook the indoor unit onto the ㉑ mounting plate.
- 3) Connect the pipes.

5-2 Left-side, left-back, or left-bottom piping

• Left-side piping

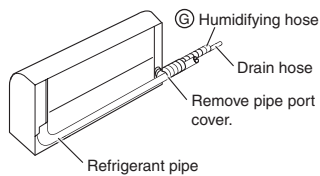

• Left-back piping

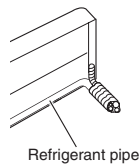

• Left-bottom piping

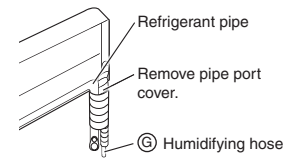

- 1) Replace the drain plug and drain hose. (Refer to "4-3 How to replace the drain plug and drain hose" on page 8.)
- 2) Pull in the refrigerant pipes and lay them so that it matches the liquid and gas piping marked on the ㉑ mounting plate.
- 3) Hook the indoor unit onto the ㉑ mounting plate.
- 4) Connect the pipes. If it is difficult to do, remove the front panel first.
- 5) Wrap the insulation on the pipes with insulation tape. If you are not replacing the drain hose, store it in the location shown below.

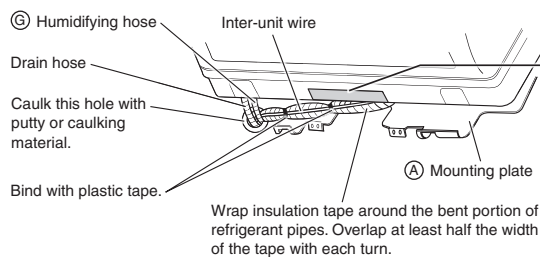

If installation is difficult, remove the pipe cover (4 tabs) and cut off the front grille (bottom).

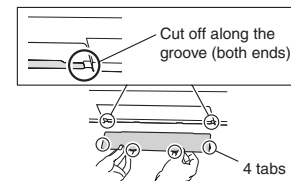

5-3 Wall embedded piping

Follow the instructions given under left-side, left-back, or left-bottom piping.

- 1) Insert the drain hose to this depth so it won't be pulled out of the drain pipe.

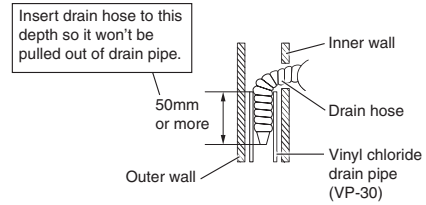

⚠ CAUTION

The indoor unit is large, so please be careful not to lose your balance when lifting it.

6. Wiring

- 1) Strip wire ends (15mm).
- 2) Match wire colours with terminal numbers on indoor and outdoor unit's terminal blocks and firmly screw wires to the corresponding terminals.
- 3) Connect the earth wires to the corresponding terminals.
- 4) Pull wires to make sure that they are securely latched up, then retain wires with wire retainer.
- 5) In case of connecting to the HA system. Run the HA connection cord and attach the S21. (Refer to "Connecting to the HA system" on page 18.)
- 6) Shape the wires so that the service lid fits securely, then close the service lid.

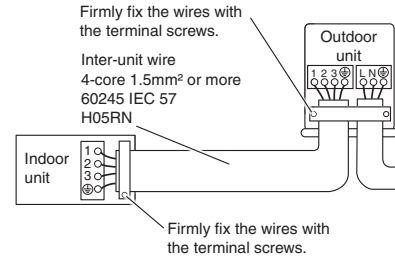
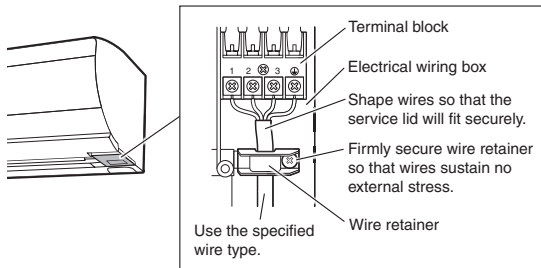

⚠ WARNING

- Do not use tapped wires, extension cords, or starburst connections, as they may cause overheating, electrical shock, or fire.
- Do not use locally purchased electrical parts inside the product. (Do not branch the power for the drain pump, etc., from the terminal block.) Doing so may cause electric shock or fire.
- Do not connect the power wire to the indoor unit. Doing so may cause electric shock or fire.

Indoor Unit Installation

7. Drain piping

- 1) Connect the drain hose, as described right.

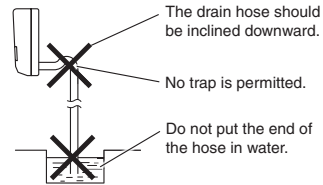

- 2) Remove the air filters and pour some water into the drain pan to check the water flows smoothly.

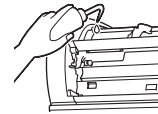

- 3) If drain hose extension or embedded drain piping is required, use appropriate parts that match the hose front end.

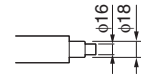
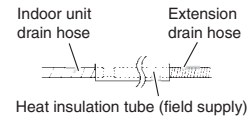
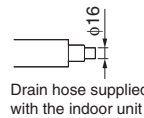
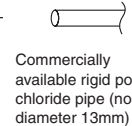
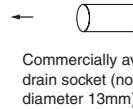
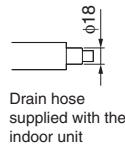

Figure of hose front end

- 4) When drain hose requires extension, obtain an extension hose with an inner diameter of 16mm. Be sure to thermally insulate the indoor section of the extension hose.



- 5) When connecting a rigid polyvinyl chloride pipe (nominal diameter 13mm) directly to the drain hose attached to the indoor unit as with embedded piping work, use any commercially available drain socket (nominal diameter 13mm) as a joint.



8. Improving installation strength

- We recommend screwing the indoor unit onto a (A) mounting plate in order to improve the installation strength.

- 1) Remove the pipe cover of the front grille (bottom). (4 tabs)
- 2) Secure the indoor unit with the (C) indoor unit fixing screws.
- 3) Attach the pipe cover.

Lift up the lower side of the indoor unit and remove the pipe cover.

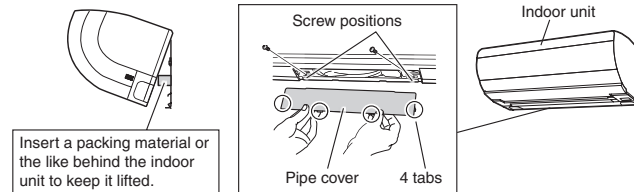

Outdoor Unit Installation Guidelines

- Where a wall or other obstacle is in the path of outdoor unit's intake or exhaust airflow, follow the installation guidelines below.
- For any of the below installation patterns, the wall height on the outlet side should be 1200mm or less.

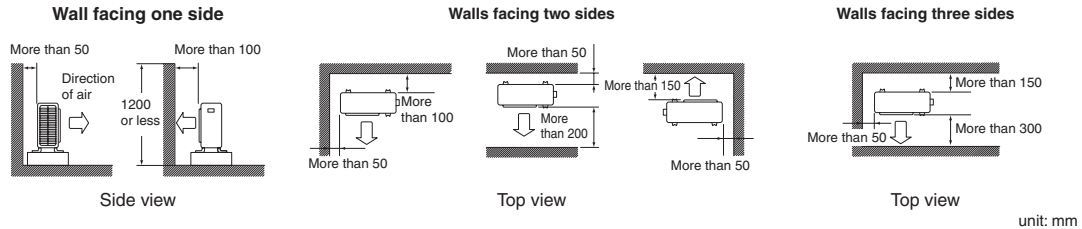

Precautions on Installation of Outdoor Unit

- Check the strength and level of the installation surface so that the unit does not cause any operating vibration or noise after installation.
- In accordance with the foundation drawing, fix the unit securely by means of the foundation bolts. (Prepare 4 sets of M8 or M10 foundation bolts, nuts and washers each which are available on the market.)
- It is best to screw in the foundation bolts until their ends are 20mm from the foundation surface.

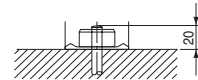

Outdoor Unit Installation

1. Installing outdoor unit

- 1) When installing the outdoor unit, refer to "Choosing an Installation Site" on page 5 and the "Indoor/Outdoor Unit Installation Drawings" on page 6.
- 2) If drain work is necessary, follow the procedures below.

2. Drain work

- 1) Use ⊕ drain socket for drainage.
- 2) If the drain port is covered by a mounting base or floor surface, place additional foot bases of at least 30mm in height under the outdoor unit's feet.
- 3) In cold areas, do not use a drain hose with the outdoor unit. (Otherwise, drain water may freeze, impairing heating performance.)

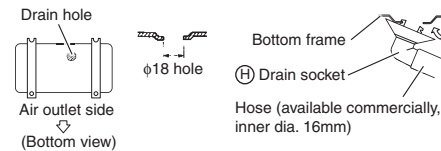

3. Flaring the pipe end

- 1) Cut the pipe end with a pipe cutter.
- 2) Remove burrs with the cut surface facing downward so that the chips do not enter the pipe.
- 3) Put the flare nut on the pipe.
- 4) Flare the pipe.
- 5) Check that the flaring is properly made.

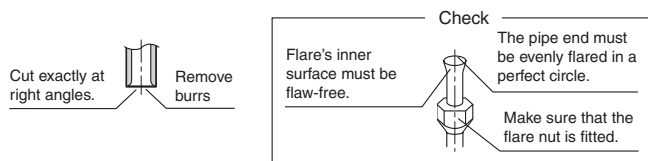

Set exactly at the position shown below.

Die	Flaring		
	Flare tool for R32 or R410A	Conventional flare tool	
A	Clutch-type	Clutch-type (Rigid-type)	Wing-nut type (Imperial-type)
	0-0.5mm	1.0-1.5mm	1.5-2.0mm

⚠ WARNING

- Do not use mineral oil on flared part.
- Prevent mineral oil from getting into the system as this would reduce the lifetime of the units.
- Never use piping which has been used for previous installations. Only use parts which are delivered with the unit.
- Never install a drier to this R32 unit in order to guarantee its lifetime.
- The drying material may dissolve and damage the system.
- Incomplete flaring may cause refrigerant gas leakage.

Outdoor Unit Installation

4. Refrigerant piping

⚠ CAUTION

- Use the flare nut fixed to the main unit. (To prevent cracking of the flare nut by aged deterioration.)
 - To prevent gas leakage, apply refrigeration oil only to the inner surface of the flare. (Use refrigeration oil for R32.)
 - Use torque wrenches when tightening the flare nuts to prevent damage to the flare nuts and gas leakage.
-
- Align the centres of both flares and tighten the flare nuts 3 or 4 turns by hand. Then tighten them fully with the torque wrenches.
 - Refrigerant oil for R410A can also be used for application to the inner flare.

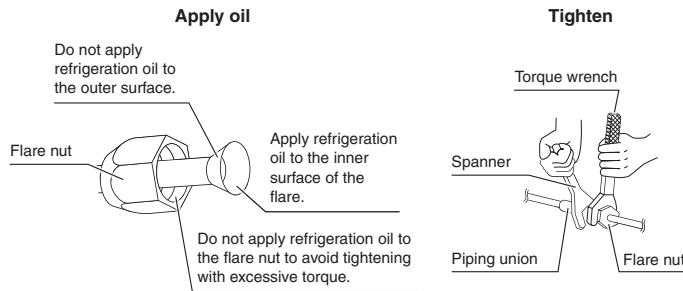

Flare nut tightening torque	
Gas side	Liquid side
9.5mm	6.4mm
32.7-39.9N · m (333-407kgf · cm)	14.2-17.2N · m (144-175kgf · cm)

Valve cap tightening torque	
Gas side	Liquid side
9.5mm	6.4mm
21.6-27.4N · m (220-280kgf · cm)	

Service port cap tightening torque	
10.8-14.7N · m (110-150kgf · cm)	

5. Refrigerant piping work

5-1 Cautions on pipe handling

- Protect the open end of the pipe against dust and moisture.
- All pipe bends should be as gentle as possible. Use a pipe bender for bending.

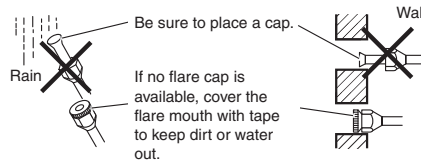

5-2 Selection of copper and heat insulation materials

When using commercial copper pipes and fittings, observe the following:

- Insulation material: Polyethylene foam
Heat transfer rate: 0.041 to 0.052W/mK (0.035 to 0.045kcal/mh°C)
Refrigerant gas pipe's surface temperature reaches 110°C max.
Choose heat insulation materials that will withstand this temperature.
- Be sure to insulate both the gas and liquid piping and to provide insulation dimensions as below.

Seal the edge of the insulation if there is a possibility that the condensation from the stop valve might drip onto the indoor unit through the gap between the insulation and the pipe.

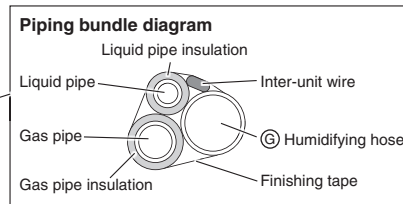
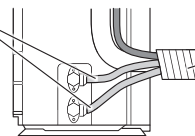

Gas side	Liquid side	Gas pipe thermal insulation	Liquid pipe thermal insulation
O.D. 9.5mm	O.D. 6.4mm	I.D. 12-15mm	I.D. 8-10mm
Minimum bend radius		Thickness 10mm Min.	
30mm or more			
Thickness 0.8mm (C1220T-O)			

- Use separate thermal insulation pipes for gas and liquid refrigerant pipes.

6. Evacuating the air with a vacuum pump and checking gas leakage

⚠ WARNING

- Do not mix any substance other than the specified refrigerant (R32) into the refrigeration cycle.
- When refrigerant gas leaks occur, ventilate the room as soon and as much as possible.
- R32, as well as other refrigerants, should always be recovered and never be released directly into the environment.
- **Use tools for R32 or R410A (such as the gauge manifold, charging hose, or vacuum pump adapter).**

- When piping work is completed, it is necessary to evacuate the air with a vacuum pump and check for gas leakage.
- Use a hexagonal wrench (4mm) to operate the stop valve rod.
- All refrigerant pipe joints should be tightened with a torque wrench at the specified tightening torque.

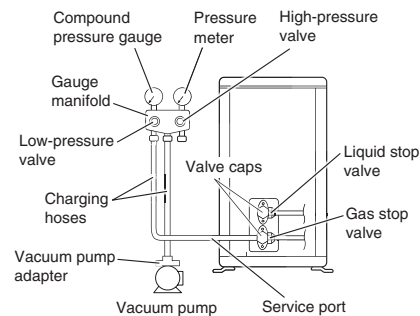

- 1) Connect projection side of charging hose (which comes from gauge manifold) to gas stop valve's service port.
- 2) Fully open gauge manifold's low-pressure valve (Lo) and completely close its high-pressure valve (Hi).
(High-pressure valve subsequently requires no operation.)
- 3) Do vacuum pumping and make sure that the compound pressure gauge reads -0.1MPa (-76cmHg).
(The vacuum pump should run for at least 10 minutes.)
- 4) Close gauge manifold's low-pressure valve (Lo) and stop vacuum pump.
(Keep this state for a few minutes to make sure that the compound pressure gauge pointer does not swing back.)*1
- 5) Remove covers from liquid stop valve and gas stop valve.
- 6) Turn the liquid stop valve's rod 90° counterclockwise with a hexagonal wrench to open valve.
Close it after 5 seconds, and check for gas leakage.
Using soapy water, check for gas leakage from indoor unit's flare and outdoor unit's flare and valve rods.
After the check is complete, wipe all soapy water off.
- 7) Disconnect charging hose from gas stop valve's service port, then fully open liquid and gas stop valves.
(Do not attempt to turn valve rod beyond its stop.)
- 8) Tighten valve caps and service port caps for the liquid and gas stop valves with a torque wrench at the specified torques.

*1 If the compound pressure gauge pointer swings back, refrigerant may have water content or a loose pipe joint may exist. Check all pipe joints and retighten nuts as needed, then repeat steps 2) through 4).

Outdoor Unit Installation

7. Wiring

⚠ WARNING

- Do not use tapped wires, extension cords, or starburst connections, as they may cause overheating, electrical shock, or fire.
- Do not use locally purchased electrical parts inside the product. (Do not branch the power for the drain pump, etc., from the terminal block.) Doing so may cause electric shock or fire.
- Be sure to install an earth leak detector. (One that can handle higher harmonics.)
(This unit uses an inverter, which means that an earth leak detector capable of handling harmonics must be used in order to prevent any malfunction of the earth leak detector itself.)
- Use an all-pole disconnection type circuit breaker with at least 3mm between the contact point gaps.
- The earth leakage circuit breaker must operate at 30mA or lower.
- Do not connect the power wire to the indoor unit. Doing so may cause electric shock or fire.

- Do not turn on the circuit breaker until all work is completed.
 - Strip the insulation from the wire (20mm).
 - Connect the inter-unit wires between the indoor and outdoor units **so that the terminal numbers match**. Tighten the terminal screws securely. We recommend a flathead screwdriver be used to tighten the screws. The screws are packed with the terminal block.

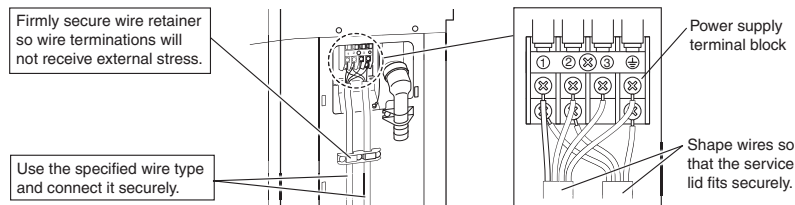
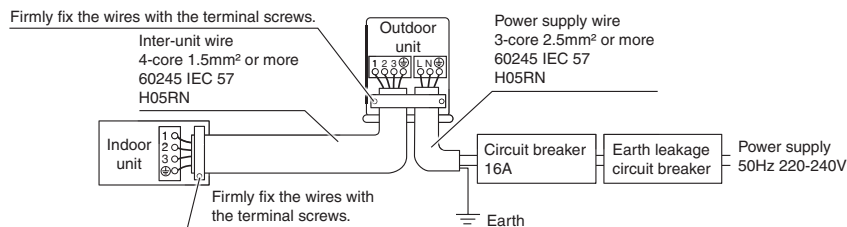

⚠ CAUTION

- When using stranded wires, make sure to use a round crimp-style terminal for connection to the power supply terminal block. Place the round crimp-style terminals on the wires up to the covered part and secure in place.
- Use the following method when installing a round crimp-style terminal.

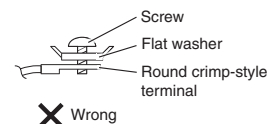
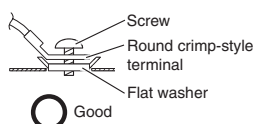
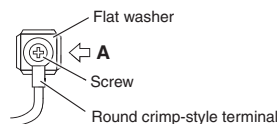
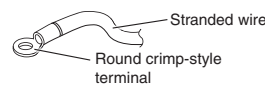

Arrow view A

- Use the following method when installing a single core wire.

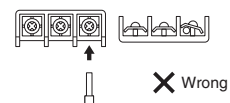

8. Connecting the humidifying hose

- If the air conditioner is operated without the ⑥ humidifying hose connected, humidified air fills the outdoor unit and may cause a short-circuit on the printed circuit board. Be sure to connect it.
 - Connect the ⑥ humidifying hose to the outdoor humidifying duct.
 - Apply a ⑦ binding band to prevent the ⑥ humidifying hose from coming off.

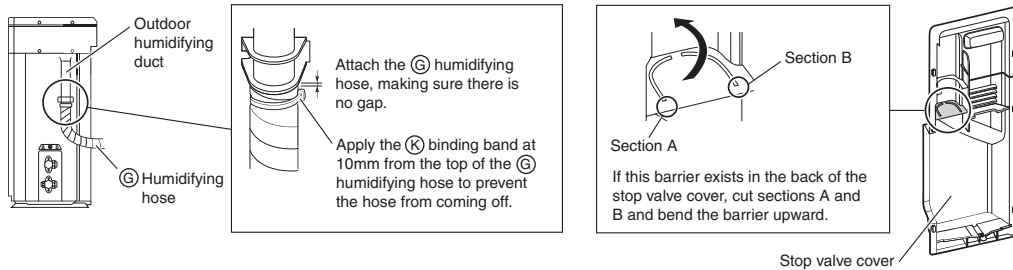

Binding part of binding band

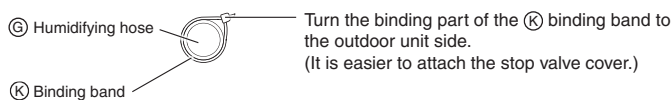

9. Setting the humidifying hose length

- Set the humidifying hose length to ensure humidifying capacity. Use the remote controller to set the humidifying hose length. When doing this, power on the unit as communication is established between the unit and the remote controller.
 - Press **SETUP** for at least 5 seconds.
 - The default menu is displayed.
 - To exit the menu, press **CANCEL** or leave it unoperated for 60 seconds. The display will return to the normal display.
 - Press **▲**. Select "Hose length".
 - Press **APPLY** to enter the humidifying hose length setting mode.
 - Be sure to direct the remote controller toward the indoor unit.
 - The currently set humidifying hose length will be displayed. (No setting is made by default.)
 - Press **▲** and set the humidifying hose length.

The humidifying hose length can be set in 5 stages:

~3M	3.1M~4M	4.1M~6M	6.1M~8M	8.1M~10M
-----	---------	---------	---------	----------
 - When you set the humidifying hose length, press **APPLY**.
 - Direct the remote controller toward the indoor unit.
 - Press **CANCEL**.
 - The setting of the humidifying hose length is complete.
 - If you set the humidifying hose length incorrectly, cancel the setting with "Length Reset" at step 4), and then set the length again. When the humidifying hose length is already set, only reset is displayed at step 4).
 - Incorrectly setting the humidifying hose can cause poor performance and noise. Be sure to set it. (When not set, error code "UA" will be displayed.)

< When the unit cannot be powered on >

- When you set the humidifying hose length without powering on the indoor unit. In the above step 3), "Receive failure" is displayed. However, with the operations of steps 4) and 5), "Length set" is displayed, and the humidifying hose length is saved in the remote controller. The error code "H" should be displayed during the operations of steps 4) and 5).
- When you operate the air conditioner, the humidifying hose length will be sent to the indoor unit and the humidifying hose length will be set.

Installation Tips

■ Removing and installing the front panel

• Removal method

- 1) Hook your fingers on both sides of the front panel and open until the panel stops.
Pushing further up from the stopping position allows the panel to be removed more easily.
- 2) While pushing the left side front panel shaft outward, push up the front panel and remove it. (Remove the right side front panel shaft in the same manner.)
- 3) After removing both front panel shafts, pull the front panel toward yourself and remove it.

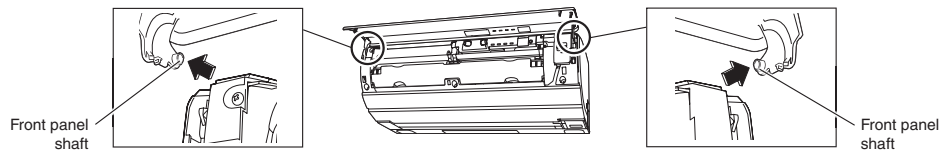

• Installation method

- Insert the right and left front panel shafts on the front panel into the shaft holes one at a time and slowly close the panel.
(Press on both sides of the front panel.)

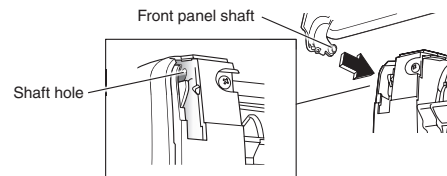

■ Removing and installing the front grille

• Removal method

- 1) Remove the front panel.
- 2) Direct the flap and the auxiliary flap downward.
- 3) Remove the streamer unit. (See Fig. 1)
- 4) Remove the screws that secure the front grille (right). (3 screws) (See Fig. 2)
- 5) While lifting up the front grille (top) with the flathead screwdriver, unhook the tabs and remove the front grille (right). (See Fig. 3)
- 6) Remove the screws that secure the front grille (left), (2 screws) (See Fig. 4)
- 7) While lifting up the front grille (top) with the flathead screwdriver, unhook the tabs and remove the front grille (left).
- 8) Insert the flathead screwdriver and remove the screw cover. (See Fig. 5)
- 9) Remove the screw that secures the service lid and remove the service lid. (See Fig. 6)
- 10) While lifting up the centre part of the front grille (bottom) toward yourself, unhook the 3 tabs. (See Fig. 7)

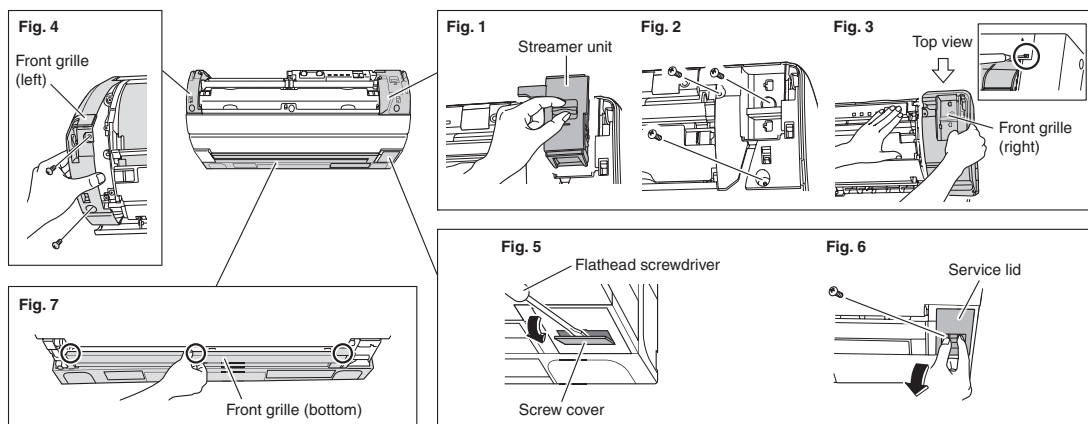

• **Installation method**

- 1) Attach the front grille (bottom).
Make sure that the tabs on both sides are securely hooked. (See Fig. 8)
- 2) Attach the service lid and secure it with a screw.
- 3) Attach the screw cover.
- 4) Attach the front grilles (left and right) and tighten the mounting screws (2 screws for the left side, 3 for the right side).
The front grilles (left and right) are likely to override the front grille (bottom). Pay due caution when attaching them. (See Fig. 9)

Fig. 8

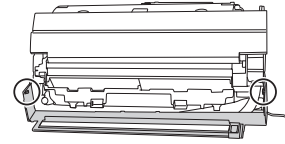
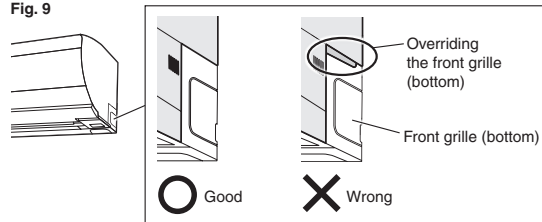

Fig. 9



■ **How to set the different addresses**

- When 2 indoor units are installed in one room, the 2 wireless remote controllers can be set for different addresses.
Change the address setting of one of the two units.
- For details, refer to the operation manual.

■ **Connecting to the HA system
(Wired remote controller, central remote controller etc.)**

- 1) Remove the front panel, streamer unit, and front grille (right). (3 screws) (Refer to page 17)
- 2) Remove the electrical wiring box cover. (3 tabs)
- 3) Insert the HA connection cord into the HA connector "S21" (white).
- 4) Route the HA connection cord.
- 5) Reattach the electrical wiring box cover to the original position. (3 tabs)
- 6) Reattach the front grille (right), streamer unit, and front panel to the original positions.

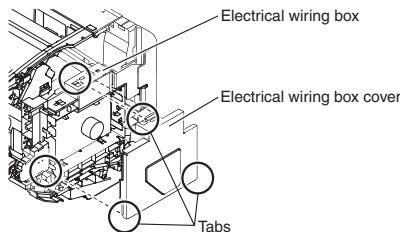

How to route the HA connection cord

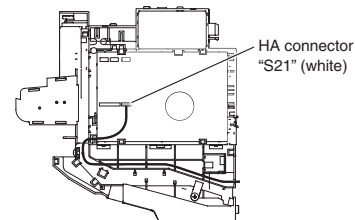

■ **Pump down operation**

In order to protect the environment, be sure to pump down when relocating or disposing of the unit.

- 1) Remove the valve cap from liquid stop valve and gas stop valve.
- 2) Carry out forced cooling operation.
- 3) After 5 to 10 minutes, close the liquid stop valve with a hexagonal wrench.
- 4) After 2 to 3 minutes, close the gas stop valve and stop forced cooling operation.

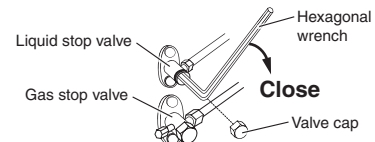

After the operation, reattach the valve cap to the original condition.

< **Forced cooling operation** >

Using the indoor unit ON/OFF switch

Open the front panel and press the indoor unit ON/OFF switch for at least 5 seconds. (The operation will start.)

- Forced cooling operation will stop automatically after about 15 minutes.
To stop the operation, press the indoor unit ON/OFF switch.

CAUTION

After closing the liquid stop valve, close the gas stop valve within 3 minutes, then stop the forced cooling operation.

Trial Operation and Testing

1. Setting of the position where the indoor unit is installed

- By setting the room shape and the relation with the installation position, proper airflow direction control can be obtained. If this is not set correctly, proper indoor temperature control may not be provided depending on the airflow settings.

For details, refer to the operation manual.

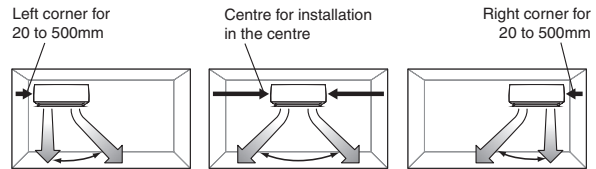

- Press **SETUP**.
- Press **▲** to select "INSTALLED POSITION" and press **APPLY**.
- Select the appropriate item and press **APPLY**.

2. Installing the air-purifying and deodorising filter

- Open the front panel and remove the dust box. Pull down the filter stopper frame (yellow) on the right side.

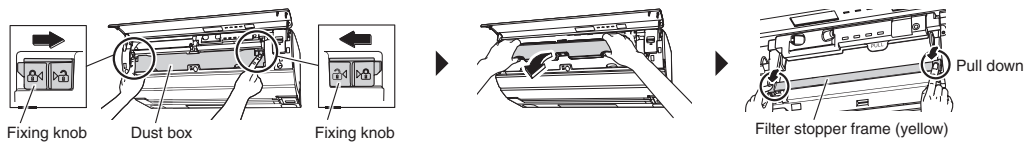

- Direct the display unit (black) upward and remove the air filter.

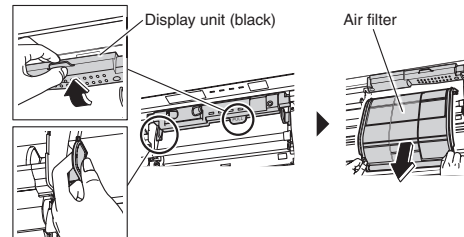

- Install the **(B)** air-purifying and deodorising filter.

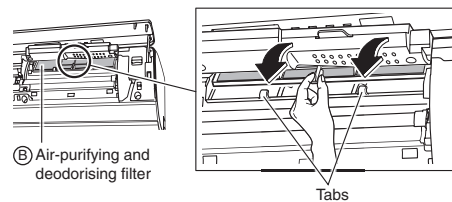

- Restore the air filter and the dust box to the original positions.

3. Trial operation and testing

3-1 Measure the supply voltage and make sure that it falls in the specified range

3-2 Trial operation should be carried out in either COOLING or HEATING operation

- In COOLING operation, select the lowest programmable temperature; in HEATING operation, select the highest programmable temperature.
 - Trial operation may be disabled in either mode depending on the indoor temperature. Use the remote controller for trial operation as described below.
 - After trial operation is complete, set the temperature to a normal level (26°C to 28°C in COOLING operation, 20°C to 22°C in HEATING operation).
 - For protection, the system disables restart operation for 3 minutes after it is turned off.

3-3 To perform a trial operation for humidifying operation, activate trial operation mode from the remote controller following the instructions below and press HUMIDIFY

Trial operation from remote controller
1) Press SETUP for at least 5 seconds. (The default menu will be displayed.)
2) Press ↑ to select "Test mode" and press APPLY . <ul style="list-style-type: none"> • The unit enters trial operation mode, and "T" is displayed on the screen.
3) Press the button for the operation mode (COOLING/HEATING/HUMIDIFY) you want to test. <ul style="list-style-type: none"> • Trial operation will stop automatically after about 30 minutes. To quit a trial operation, press OFF .

3-4 Operate the unit in accordance with the operation manual to check that it operates normally

3-5 Make sure that the air conditioner is not in operation before performing CLEANING FILTER operation

- 1) Press +FILTER and make sure that CLEANING FILTER operation functions without error.

3-6 After trial operation, reset the total power consumption

- 1) Press SETUP .
- 2) Press ↓ to select "RESET USED POWER" and press APPLY .
- 3) "RESET with APPLY" is displayed. When you press APPLY , the total power consumption is reset.
- Even when the air conditioner is not operating, it consumes some electric power. If the customer is not going to use the unit soon after it is installed, turn off the circuit breaker to avoid wasting electricity.

4. Test items

Test items	Symptom	Check
Indoor and outdoor units are installed properly on solid bases.	Fall, vibration, noise, narrower detectable range of the INTELLIGENT EYE sensor	
Are the air filter and the dust box attached properly?	Noise, water leakage, CLEANING FILTER operation disabled	
Did you install the air-purifying and deodorising filter?	Noise, water leakage, CLEANING FILTER operation disabled	
Have you performed a leak test to ensure that there are no refrigerant gas leaks?	Incomplete cooling/heating function	
Refrigerant gas and liquid pipes and indoor drain hose extension are thermally insulated.	Water leakage	
Draining line is properly installed.	Water leakage	
Did you ask the customer whether drain work for the outdoor unit is necessary?	Dripping of drain water from the hole in the bottom of the outdoor unit	
Does the drain hose produce abnormal noise (clopping sound) when using the ventilation fan or others?	Noise (Use of optional air cut drain plug.)	
System is properly earthed.	Electric shock hazard	
The specified wires are used for inter-unit wiring connections.	Inoperative or burn damage	
Indoor or outdoor unit's air inlet or outlet has clear path of air.	Incomplete cooling/heating function	
Stop valves are opened.	Incomplete cooling/heating function	
Indoor unit properly receives remote controller commands.	Inoperative	
Did you check the address setting?	Inoperative	
Did you set the humidifying hose length?	<ul style="list-style-type: none"> • The OPERATION lamp blinks for about 2 minutes from power-on while the air conditioner is stopped. • Poor performance and noise 	
Did you set the room shape properly?	Poor cooling performance	

2. Operation Manual

Safety precautions



Read the precautions in this manual carefully before operating the unit.



This appliance is filled with R32.

- Keep this manual where the user can easily find it.
- The precautions described herein are classified as WARNING and CAUTION. They both contain important information regarding safety. Be sure to observe all precautions without fail.



WARNING Failure to follow these instructions properly may result in personal injury or loss of life.



CAUTION Failure to observe these instructions properly may result in property damage or personal injury, which may be serious depending on the circumstances.



Never attempt.



Be sure to follow the instructions.



Be sure to establish an earth connection.

- After reading, keep this manual in a convenient place so that you can refer to it whenever necessary. If the equipment is transferred to a new user, be sure also to hand over the manual.

WARNING



- Do not use means to accelerate the defrosting process or to clean, other than those recommended by the manufacturer.
- The appliance must be stored in a room without continuously operating ignition sources (for example: open flames, an operating gas appliance or an operating electric heater).
 - Do not pierce or burn.
 - Be aware that refrigerants may not contain an odour.
- The appliance must be installed, operated and stored in a room with a floor area larger than 1.8m².
- In order to avoid fire, explosion or injury, do not operate the unit when harmful, among which flammable or corrosive gases, are detected near the unit.
- Be aware that prolonged, direct exposure to cool or warm air from the air conditioner, or to air that is too cool or too warm can be harmful to your physical condition and health.
- Do not place objects, including rods, your fingers, etc., in the air inlet or outlet. Product malfunctioning, product or injury damage may result due to contact with the air conditioner's high-speed fan blades.
- Do not attempt to repair, dismantle, reinstall or modify the air conditioner yourself as this may result in water leakage, electric shocks or fire hazards.
- Do not use flammable spray near the air conditioner, or otherwise fire may result.
- Do not use a refrigerant other than the one indicated on the outdoor unit (R32) when installing, moving or repairing. Using other refrigerants may cause trouble or damage to the unit, and personal injury.
- To avoid electric shocks, do not operate with wet hands.



- Beware of fire in case of refrigerant leakage. If the air conditioner is not operating correctly, i.e. not generating cool or warm air, refrigerant leakage could be the cause. Consult your dealer for assistance. The refrigerant within the air conditioner is safe and normally does not leak. However, in the event of a leakage, contact with a naked burner, heater or cooker may result in generation of noxious gas. Do not use the air conditioner until a qualified service person confirms that the leakage has been repaired.
- Do not attempt to install or repair the air conditioner yourself. Improper workmanship may result in water leakage, electric shocks or fire hazards. Please contact your local dealer or qualified personnel for installation and maintenance work.
- When the air conditioner is malfunctioning (giving off a burning odour, etc.) turn off power to the unit and contact your local dealer. Continued operation under such circumstances may result in a failure, electric shocks or fire hazards.
- Be sure to install an earth leakage circuit breaker. Failure to install the earth leakage circuit breaker may result in electric shocks or fire.





- Be sure to earth the unit. Do not earth the unit to a utility pipe, lightning conductor or telephone earth lead. Imperfect earthing may result in electric shocks.

CAUTION



- Do not use the air conditioner for purposes other than those for which it is intended. Do not use the air conditioner for cooling precision instruments, food, plants, animals or works of art as this may adversely affect the performance, quality and/or longevity of the object concerned.
- Do not expose plants or animals directly to airflow from the unit as this may cause adverse effects.

-
-
-  Do not place appliances that produce naked flames in places exposed to the airflow from the unit as this may impair combustion of the burner.
 - Do not block air inlets nor outlets. Impaired airflow may result in insufficient performance or trouble.
 - Do not sit on the outdoor unit, put things on the unit, or pull the unit. Doing so may cause accidents, such as falling or toppling down, thus resulting in injury, product malfunctioning, or product damage.
 - Do not place objects that are susceptible to moisture directly beneath the indoor or outdoor units. Under certain conditions, condensation on the main unit or refrigerant pipes, air filter dirt or drain blockage may cause dripping, resulting in fouling or failure of the object concerned.
 - After prolonged use, check the unit stand and its mounts for damage. If they are left in a damaged condition, the unit may fall and cause injury.
 - To avoid injury, do not touch the air inlet or aluminium fins of the indoor or outdoor units.
 - The appliance is not intended for use by unattended young children or infirm persons. Impairment of bodily functions and harm to health may result.
 - Children should be supervised to ensure that they do not play with the unit or its remote controller. Accidental operation by a child may result in impairment of bodily functions and harm health.
 - Avoid impacts to the indoor and outdoor units, or otherwise product damage may result.
 - Do not place flammable items, such as spray cans, within 1m of the air outlet.
The spray cans may explode as a result of hot air from the indoor or outdoor units.
 - Be careful not to let pets urinate on the air conditioner. Urination on the air conditioner may result in electric shocks or fire.
 - Do not wash the air conditioner with water, as this may result in electric shocks or fire.
 - Do not place water containers (vases etc.) above the unit, as this may result in electric shocks or fire hazards.
-
-  To avoid oxygen depletion, ensure that the room is adequately ventilated if equipment such as a burner is used together with the air conditioner.
 - Before cleaning, be sure to stop unit operation, turn off the circuit breaker or remove the power cord. Otherwise, an electric shock and injury may result.
 - Only connect the air conditioner to the specified power supply circuit. Power supplies other than the one specified may result in electric shocks, overheating and fires.
 - Arrange the drain hose to ensure smooth drainage. Imperfect drainage may cause wetting of the building, furniture etc.
 - Do not place objects in direct proximity of the outdoor unit and do not let leaves and other debris accumulate around the unit. Leaves are a hotbed for small animals which can enter the unit. Once in the unit, such animals can cause malfunctions, smoke or fire when making contact with electrical parts.
 - Do not place objects around the indoor unit.
Doing so may have an adverse influence on the performance, product quality, and life of the air conditioner.
 - This appliance is not intended to be used by persons with reduced physical, sensory or mental capabilities, or with lack of operation knowledge, unless they have been given supervision or instruction concerning the appliance use by person responsible for their safety.
Keep out of children's reach to ensure that they do not play with the appliance.
 - For care and cleaning, call service personnel.
-

P002

This is an appliance that is not accessible to the general public.

Installation site

< To install the air conditioner in the following types of environments, consult the dealer >

- Places with an oily environment or where steam or soot occurs.
- Salty environment such as coastal areas.
- Places where sulfide gas occurs such as hot springs.
- Places where snow may block the outdoor unit.
- The indoor unit is at least 1m away from any television or radio set (unit may cause interference with the picture or sound).
- The drain from the outdoor unit must be discharged to a place of good drainage.

Consider nuisance to your neighbours from noises

< For installation, choose a place as described below >

- A place solid enough to bear the weight of the unit which does not amplify the operating sound or vibration.
- A place from where the air discharged from the outdoor unit or the operating sound will not annoy your neighbours.

Electrical work

- For power supply, be sure to use a separate power circuit dedicated to the air conditioner.

System relocation

- Relocating the air conditioner requires specialized knowledge and skills. Please consult the dealer if relocation is necessary for moving or remodeling.

Names and functions of parts

Indoor unit

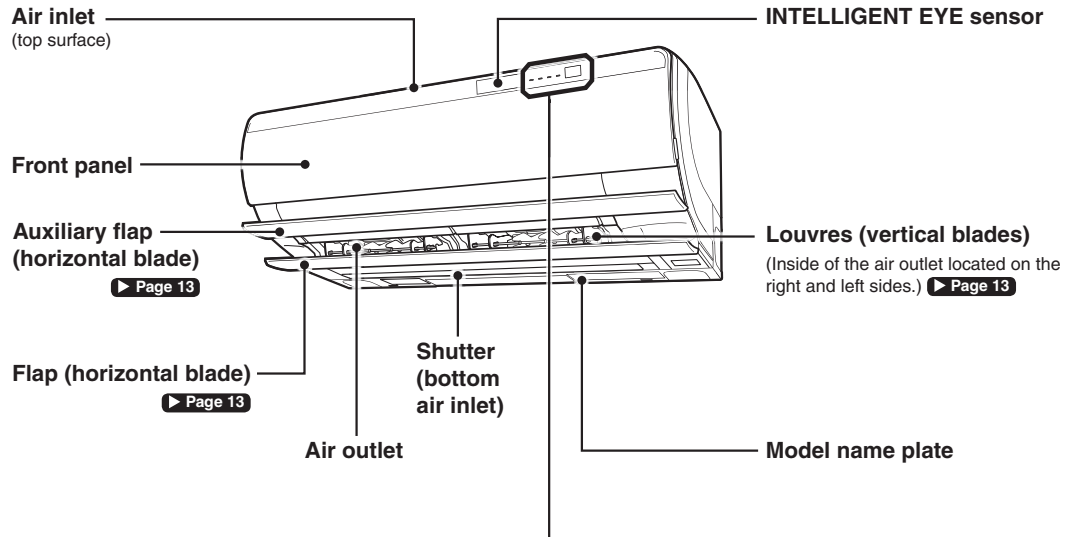

■ Display

**MOLD PROOF /
CLEANING FILTER lamp (green)**

QUICK HEATING TIMER lamp (red)

OPERATION lamp (green)

TIMER lamp (orange)

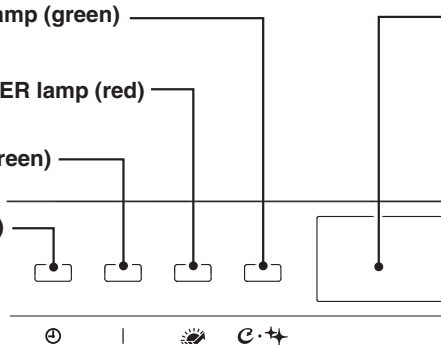

Transmitter/Receiver

- Sends/receives signals to/from the remote controller.
- The OPERATION lamp blinks with beep sound to indicate signal reception.

Case	Sound type
Operation start	beep-beep
Setting change	beep
Operation stop	long beep

< List of lamps >

Lamp	Colour	State	Description
TIMER lamp	orange	Lights up	TIMER is set. ▶ Page 17
		Blinks	It is time to clean the streamer unit. ▶ Page 36
OPERATION lamp	green	Lights up	The air conditioner is running.
		Blinks	Check the error code. ▶ Page 40
QUICK HEATING TIMER lamp	dark red	Lights up	QUICK HEATING TIMER is set. ▶ Page 21
	bright red		Preparatory heating operation or QUICK HEATING TIMER operation is running. ▶ Page 21
MOLD PROOF / CLEANING FILTER lamp	green	Lights up	The air conditioner is running with the AUTO MOLD PROOF set to "On". ▶ Page 27
			MOLD PROOF operation or CLEANING FILTER operation is running. ▶ Page 27, 28
		Blinks	It is time to clean the dust box. ▶ Page 37

When the front panel is open ▶ Page 35

■ Display unit

INTELLIGENT EYE sensor

Detects human motion to confirm that a person is in the area.

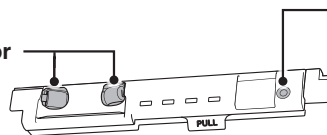

Indoor unit ON/OFF switch

- Press to start the operation with the mode set to "AUTO" and airflow rate to "AUTO". Press the button again to stop the operation.
- Use this button when no remote controller is immediately available.

Air supply filter (black)

Removes dust taken in from the outdoor air. ▶ Page 39

Humidifying temperature and humidity sensor
(inside the unit)

Detects the temperature and humidity of the humidified air to control the degree of humidity.

Dust box

Scrapes dust off the air filter with the dust brush and collects it. ▶ Page 37

Air filter (white)

(2 locations at right and left) ▶ Page 38

Streamer unit

Prevents mold and allergens with the decomposition power of the streamer discharge. ▶ Page 36

Air-purifying and deodorising filter (black)

Adsorbs mold, allergens and odour. ▶ Page 39

Indoor temperature and humidity sensor
(inside the unit)

Detects the temperature and humidity in the room.

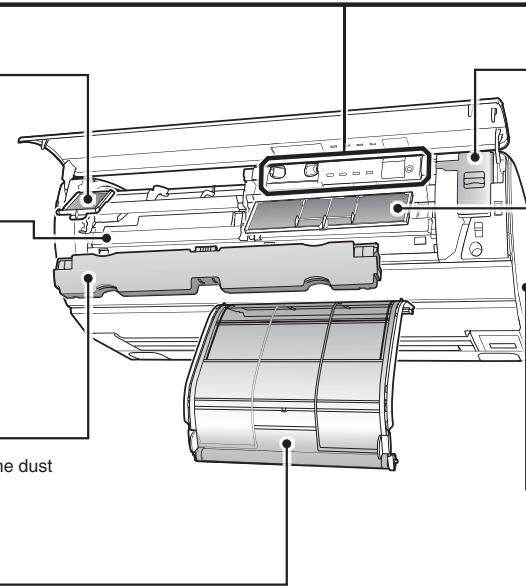

Outdoor unit

Humidifying unit air inlet
(front and back)

Humidifying unit air outlet (front)

Humidifying unit

Air inlet
(side and back)

Air outlet

Drain outlet
(rear side of the bottom)

Drains water out from the outdoor unit during HEATING or HUMID HEATING operation.

Outdoor temperature sensor
(back)

Detects the outdoor temperature.

Refrigerant pipes, inter-unit wire and humidifying hose

Earth terminal (inside)

Drain hose

Drains water from the indoor unit during COOLING, "SARARA" DRY or DRY COOLING operation.

Model name plate

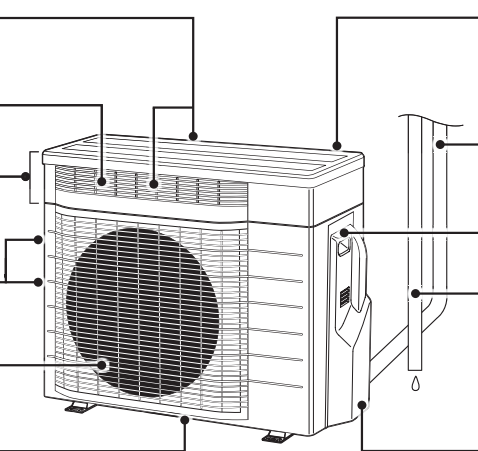

Names and functions of parts

Remote controller

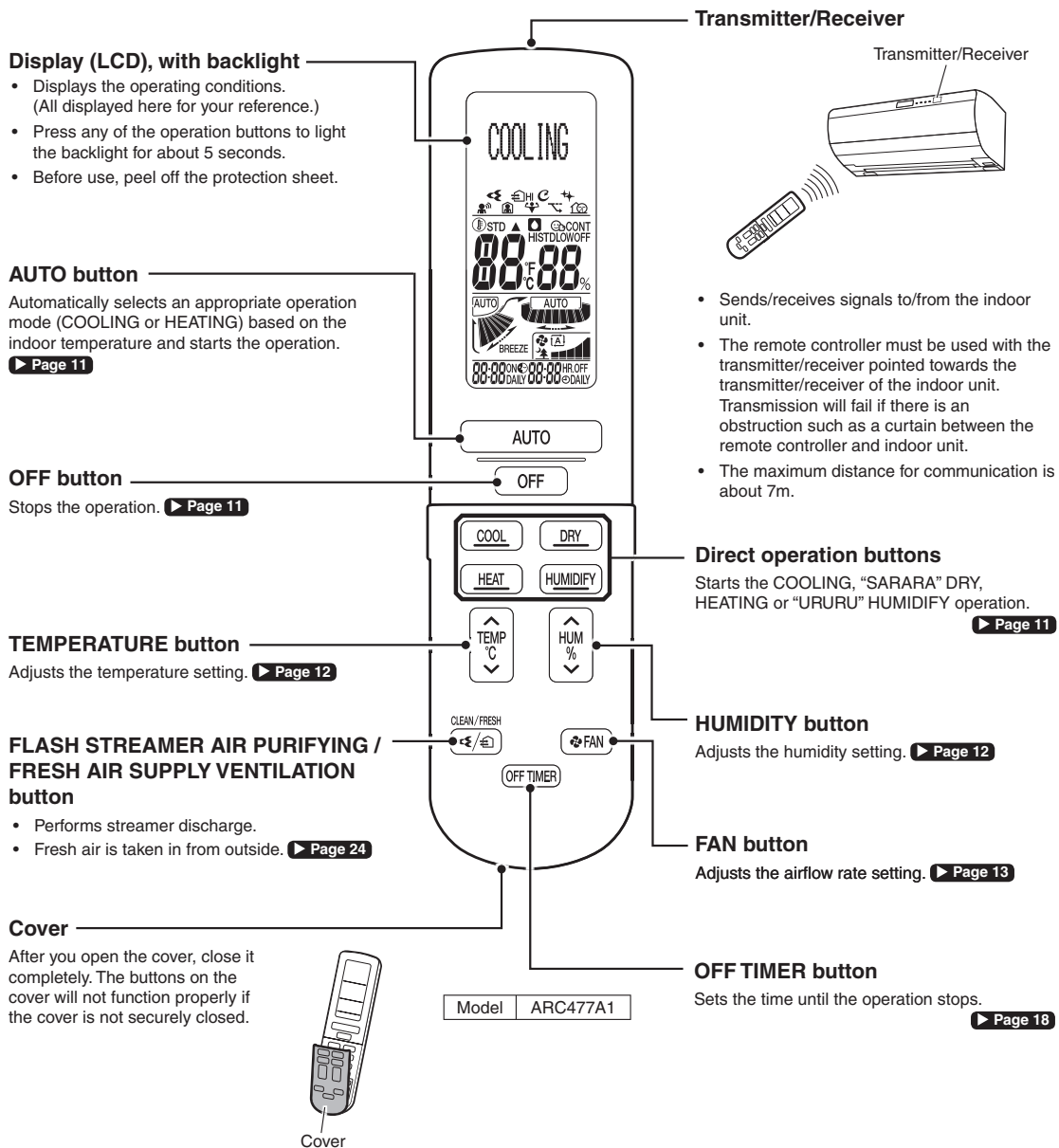

Notes on remote controller

- Take care to avoid dropping the remote controller or getting it wet. (Dropping or getting it wet may break it.)
- When the remote controller gets dirty, wipe it with a dry soft cloth.
- Signal communication may become poor if an electronic-starter-type fluorescent lamp (such as inverter-type lamps) or TV is in the room. Consult the service shop if that is the case.
- The sensitivity may become poor if the transmitter/receiver is exposed to direct sunlight.

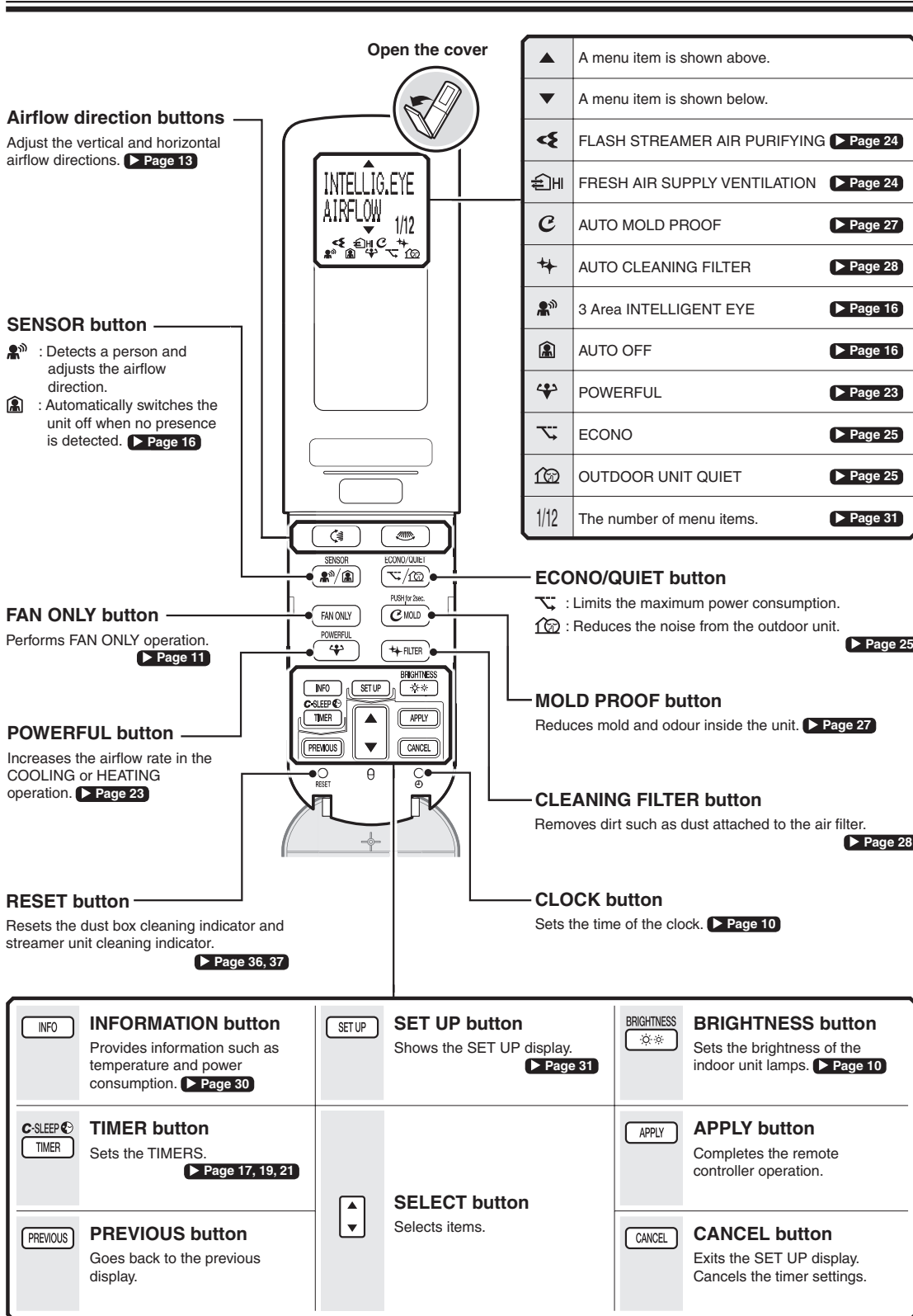

Preparation before operation

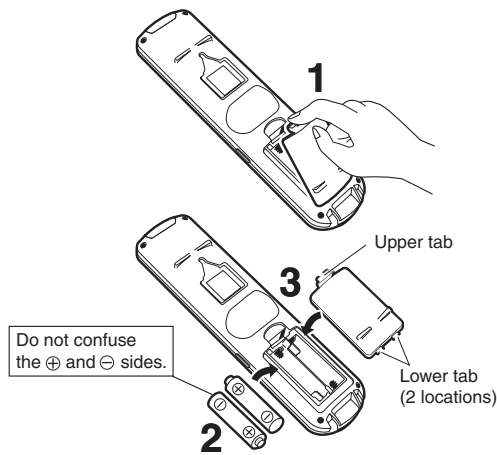

To set the batteries

1. Pull down the upper tab to open the cover.
2. Insert 2 dry batteries AA.LR6 (alkaline).
 - Using batteries other than AA.LR6 (alkaline) may lead to improper operation.
3. Insert the 2 lower tabs on the cover to put the cover back in place.

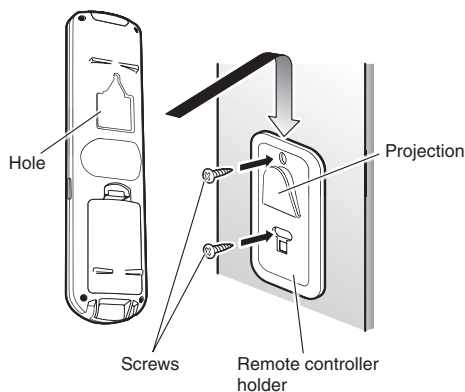

To fix the remote controller holder to a wall

1. Choose a place where the signals can reach the unit.
2. Fix the remote controller holder to a wall, a pillar, or similar location with the screws procured locally.
3. Fit the projection of the remote controller holder into the hole at the back of the remote controller.

Turn on the circuit breaker

- After the power is turned on, the flaps of the indoor unit open and close once to set the reference position.

Notes on batteries

- The batteries will last for about 1 year. If the remote controller display begins to fade and the reception degrades within 1 year, however, replace both batteries with new AA.LR6 (alkaline) ones at the same time.
- The batteries that come with the remote controller are for initial operation. The batteries may run out in less than 1 year.
- When the TIMERS are set, the settings are cancelled after replacing the batteries. Set the TIMERS again.
- When the air conditioner is not used for a long time, take the batteries out.

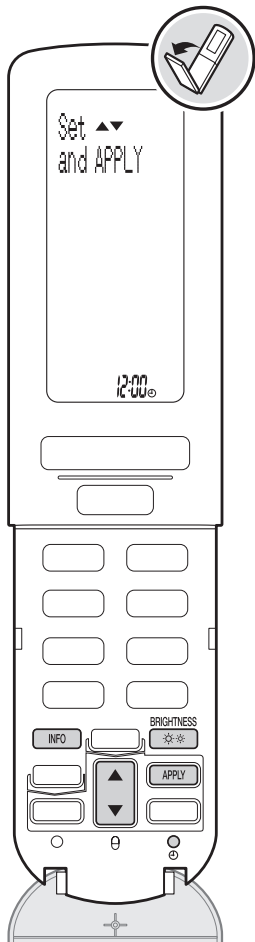

To set the clock

1. Press .

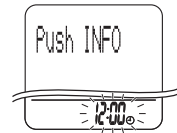

2. Press  **to set the clock to the current time.**

- Each time you press , the time changes by 1 minute. If you press and hold the button, the time changes by 10 minutes.



3. Press .

- After "CLOCK Set" appears, the normal screen is displayed again.



< To set the clock after replacing the batteries >

When the clock is set, the set time is saved in the indoor unit. After replacing the batteries, direct the remote controller toward the indoor unit and press . (The time will be set automatically.) If "12:00" keeps on blinking, follow steps 1 to 3 above.

To set the position where the indoor unit is installed

Set "INSTALLED POSITION" in the menu settings.

- To adjust the airflow properly, set the "INSTALLED POSITION".  **Page 31, 33**

To set the brightness of the indoor unit lamps

Press .



Note on setting the clock

- If the indoor unit's internal clock is not set to the correct time, the ON/OFF TIMER, COMFORT SLEEP TIMER and QUICK HEATING TIMER will not operate punctually.

To set operation modes

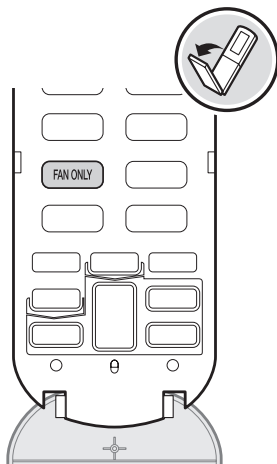
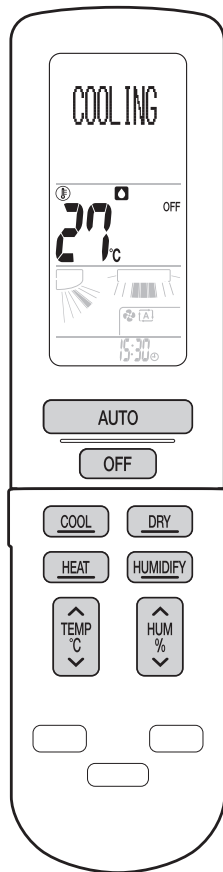

OPERATION lamp (green)

AUTO operation

To operate in appropriate operation mode (COOLING or HEATING) based on the set temperature and the indoor temperature.

Press **AUTO**.

COOLING operation

To lower the temperature.

Press **COOL**.

“SARARA” DRY operation

To lower the humidity.

Press **DRY**.

DRY COOLING operation

To lower the temperature and humidity.

Press **%** during COOLING operation.

- Press **TEMP** during “SARARA” DRY operation to switch the operation to DRY COOLING.

HEATING operation

To raise the temperature.

Press **HEAT**.

“URURU” HUMIDIFY operation

To raise the humidity.

Press **HUMIDIFY** while the unit is not operating.

HUMID HEATING operation

To raise the temperature and humidity.

Press **HUMIDIFY** during HEATING operation.

- Press the button again to go back to HEATING operation.
- Press **HUM** during HEATING operation or **TEMP** during “URURU” HUMIDIFY operation to switch the operation to HUMID HEATING.

FAN ONLY operation

To blow air.

Press **FAN ONLY**.

< To stop the operation >

Press **OFF**.

 **To adjust the temperature**

Press  .

 **To adjust the humidity**

Press  .

Notes on humidity settings

Setting	Description
 : MOISTURISING	Keeps the humidity high and does not blow air directly on the body to make the operation gentle to your skin. The operation is recommended when you are worried about the dryness of your skin. The airflow rate cannot be changed.
CONT : CONTINUOUS	Continues humidifying or dehumidifying.
HI : HIGH	Humidifies or dehumidifies with high power.
STD : STANDARD	Humidifies or dehumidifies with moderate power.
LOW : LOW	Humidifies or dehumidifies with low power.
OFF : OFF	Does not perform humidity control.

Notes on temperature and humidity settings in each operation mode

Mode	Temperature	Humidity
AUTO	18-30°C	The humidity setting is not available.
COOLING	18-32°C	*3
DRY COOLING		MOISTURISING, CONTINUOUS, LOW, STANDARD, HIGH or OFF *4
“SARARA” DRY	*1	CONTINUOUS, LOW, STANDARD or HIGH
HEATING	10-30°C	*5
HUMID HEATING		OFF *6 , LOW, STANDARD, HIGH, CONTINUOUS or MOISTURISING
“URURU” HUMIDIFY		LOW, STANDARD, HIGH or CONTINUOUS

- *1 When the temperature is changed, the DRY COOLING operation starts.
- *2 When the temperature is changed, the HUMID HEATING operation starts.
- *3 When the humidity is lowered, the DRY COOLING operation starts.
- *4 When “OFF” is selected, the COOLING operation starts.
- *5 When the humidity is raised, the HUMID HEATING operation starts.
- *6 When “OFF” is selected, the HEATING operation starts.

Notes on “SARARA” DRY operation

- This mode mixes dehumidified cool air with room air to adjust the air outlet temperature and remove moisture.
- When the indoor temperature rises, the DRY COOLING operation automatically starts.
- When the outdoor temperature is lower than the indoor temperature, dehumidifying is less effective.
- When the outdoor temperature is lower than 18°C, the room is dehumidified by alternating the COOLING and HEATING operations. In addition, the ventilation is controlled properly and the room humidity is lowered by taking outdoor air into the room. (Air intake dehumidifying)

Notes on DRY COOLING operation

- In order to lower the humidity, the airflow rate during the DRY COOLING operation becomes lower than that in the COOLING operation.
- When the humidity is not lowered, “SARARA” DRY operation automatically starts.

Note on “URURU” HUMIDIFY operation

- The humidifying unit collects moisture from the outdoor air to humidify the room.

Note on HUMID HEATING operation

- When the indoor temperature rises by HEATING operation, the indoor humidity may drop temporarily.

To adjust the airflow

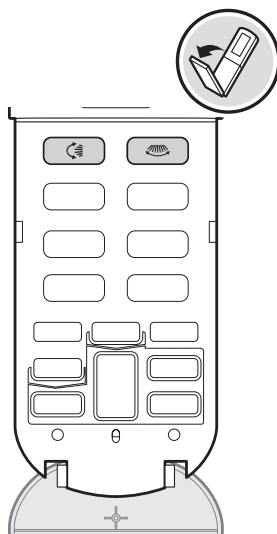
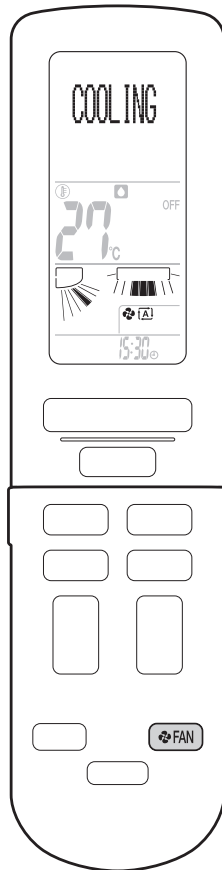

To adjust the airflow rate

Press .

- Each time you press the button, the airflow rate indicator changes. (Some indicators may not appear depending on the operation mode. ▶ Page 14)



- When the airflow is set to “”, indoor unit quiet operation will start and the operating sound from the unit will become quieter.
- If the temperature does not reach the desired point, change the airflow rate setting.

To adjust the airflow direction

< To change the vertical airflow direction >

Press .

- Each time you press the button, the airflow direction indicator changes. (Some indicators may not appear depending on the operation mode. ▶ Page 14)
- The flaps move vertically.

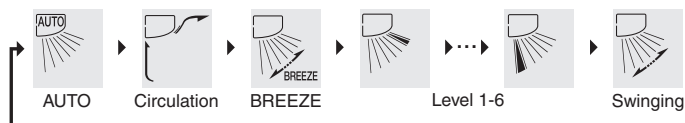

< To change the horizontal airflow direction >

Press .

- Each time you press the button, the airflow direction indicator changes. (Some indicators may not appear depending on the setting of “INSTALLED POSITION”. ▶ Page 33)
- The louvres move horizontally.

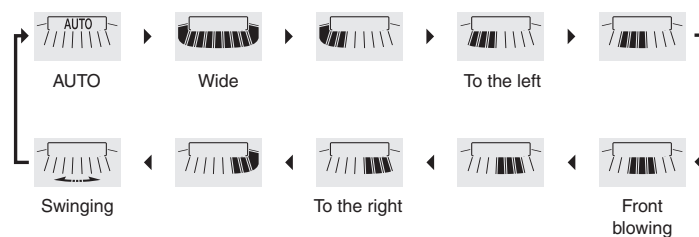

< To combine vertical and horizontal airflow directions (3-D airflow) >



Set the vertical and horizontal airflow directions to “Swinging”.



Swinging



Swinging

- The flaps and louvres move alternately.
- To cancel 3-D airflow, press  or .

Notes on airflow rate

- When the airflow rate setting is “AUTO”, starting COOLING, “SARARA” DRY, or DRY COOLING operation (including the operation selected with “AUTO”) triggers the deodorising function which reduces odour coming from the indoor unit and the unit does not blow air immediately. Wait for about 40 seconds. (SMELL PROOF)
- When the airflow rate is lowered, the flaps and louvres will stop. When the vertical airflow direction is set to “Swinging”, the flaps stop in an upward direction.
- At smaller airflow rates, the cooling/heating effect is also smaller.

< Airflow rate settings in each operation mode >

Mode	Airflow rate setting
“SARARA” DRY / DRY COOLING	AUTO
AUTO / COOLING / HEATING / “URURU” HUMIDIFY / HUMID HEATING* / FAN ONLY	AUTO, Indoor unit quiet, Airflow rate 1-5

* When the humidity is set to “MOISTURISING”, the airflow rate becomes “AUTO”.

Notes on vertical airflow direction

“AUTO”, “Circulation” and “BREEZE” airflow can be set according to the operation mode.

■ Circulation airflow



This setting blows air far using the space of the ceiling. Moreover, air can be circulated in the whole room by taking air from the shutter (bottom air inlet), to eliminate the temperature variation.

■ BREEZE airflow



This setting automatically adjusts the airflow rate and vertical airflow direction to generate a breeze-like airflow. It is a comfortable airflow even when it blows on your body.

< Settings of “AUTO”, “Circulation”, and “BREEZE” airflow in each operation mode >

Mode	Airflow direction setting		
	AUTO	Circulation	BREEZE
AUTO	✓	-	-
COOLING / “SARARA” DRY / DRY COOLING	✓	✓	✓
HEATING / “URURU” HUMIDIFY / HUMID HEATING	✓	-	-
FAN ONLY	-	✓	✓

< Settings of “AUTO” airflow in each operation mode >

Mode	Airflow direction setting
COOLING / DRY COOLING	Circulation airflow ► BREEZE airflow
HEATING / HUMID HEATING	Downward air blowing and circulation airflow are repeated.
“SARARA” DRY	When the indoor temperature is a little lower
	When the indoor temperature is a little higher
“URURU” HUMIDIFY	Circulation airflow
	BREEZE airflow

< Movable range of the flaps >

The movable range of the flaps varies according to the operation mode.

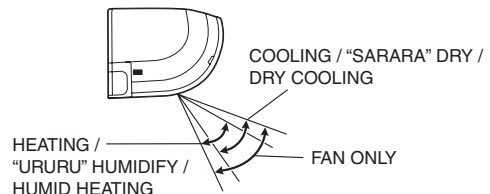

⚠ CAUTION

- Always use a remote controller to adjust the angles of the flaps and louvres. If you attempt to move the flaps and louvres forcibly by hand when they are swinging, the mechanism may be damaged.
- Always use a remote controller to adjust the louvres angles. Inside the air outlet, a fan is rotating at a high speed.

To adjust the airflow

Note on 3-D airflow

- Using 3-D airflow circulates cold air, which tends to collect at the bottom of the room, and hot air, which tends to collect near the ceiling, throughout the room, preventing areas of cold and hot developing.

Note on horizontal airflow direction

- When the horizontal airflow direction is set to "AUTO", the INTELLIGENT EYE sensor is activated. The INTELLIGENT EYE sensor detects a person in the left-side, front, and right-side areas and directs the airflow away from that person.

< INTELLIGENT EYE sensor >

The INTELLIGENT EYE sensor detects the movements of a person (heat-generating object) to confirm where people are.

Example (for Comfort) ▶ Page 16

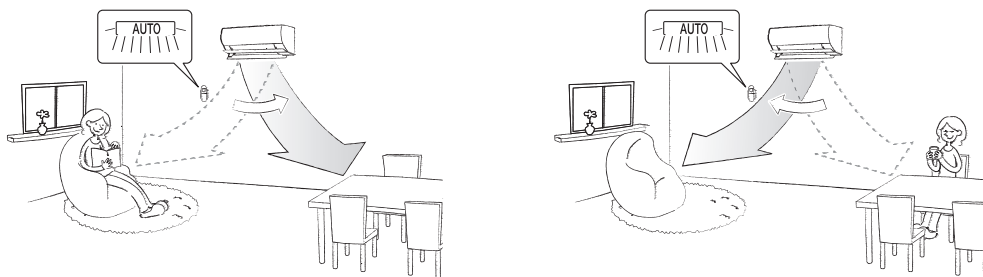

- The maximum distance that people can be detected is about 9m in front of the indoor unit.
- The movement of small animals including dogs and cats or a temperature change due to a heat-generating object such as another heating appliance or electrical appliance may incorrectly be detected as a person. In addition, areas exposed to sunlight may incorrectly be detected as a person.
- If several persons are detected in the same room, the airflow direction is changed based on the position of the last detected person.
- The area just under or right beside the indoor unit cannot be detected.
- Application range is as follows.

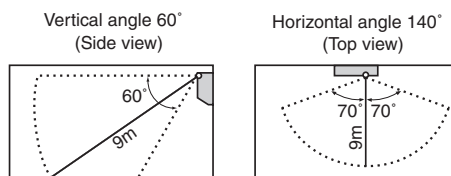

To operate wisely using the sensor

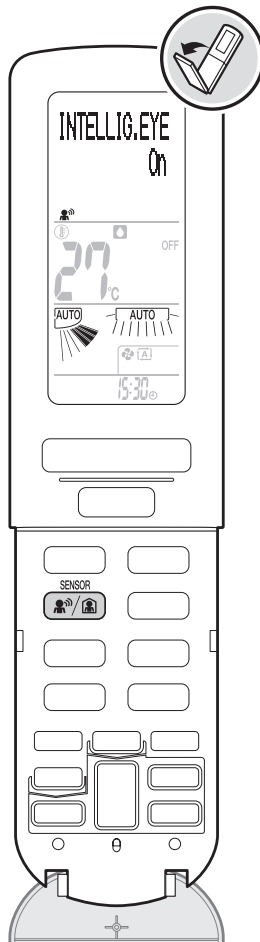

3 Area INTELLIGENT EYE operation

Whether to blow air away from a person or not can be set according to your preference. The INTELLIGENT EYE sensor detects the movement of a person and automatically changes the airflow direction.

AUTO OFF operation

When the INTELLIGENT EYE sensor judges that there is no one in the room, it changes the set temperature +2°C in COOLING / -2°C in HEATING operation. When the set time elapses with no change in the condition, the air conditioner automatically stops the operation.

< To use the operation >

Press and select the setting of your preference.

- Each time you press the button, the setting changes.

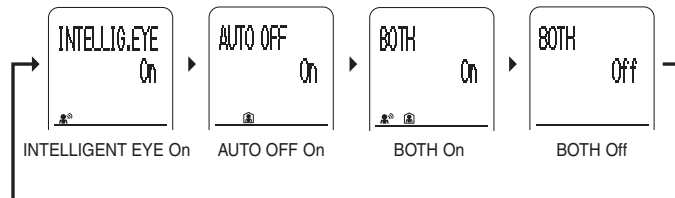

- “”, “”, or “” is displayed on the LCD.

Settings of 3 Area INTELLIGENT EYE

Focus	Blows air on a person.
Comfort *	Does not blow air on a person.

* Default setting

You can change the setting at “INTELLIG.EYE AIRFLOW” of the menu settings. ▶ [Page 31, 32](#)

Settings of AUTO OFF

1 HR *	Stops the operation 1 hour after the sensor judges that there is no one in the room.
3 HR	Stops the operation 3 hours after the sensor judges that there is no one in the room.

* Default setting

You can change the setting at “AUTO OFF time” of the menu settings. ▶ [Page 31, 32](#)

< To cancel the operation >

Press and select “BOTH Off”.

- “”, “”, or “” disappears from the LCD.

Note on 3 Area INTELLIGENT EYE operation

- POWERFUL operation is cancelled when 3 Area INTELLIGENT EYE is selected.

Note on 3 Area INTELLIGENT EYE and AUTO OFF operations

- If no presence detected in the room for 20 minutes, the air conditioner changes the set temperature +2°C in COOLING / -2°C in HEATING operation.
When the indoor temperature exceeds 30°C, the operation changes the temperature +1°C in COOLING operation from set temperature.

To use the timer

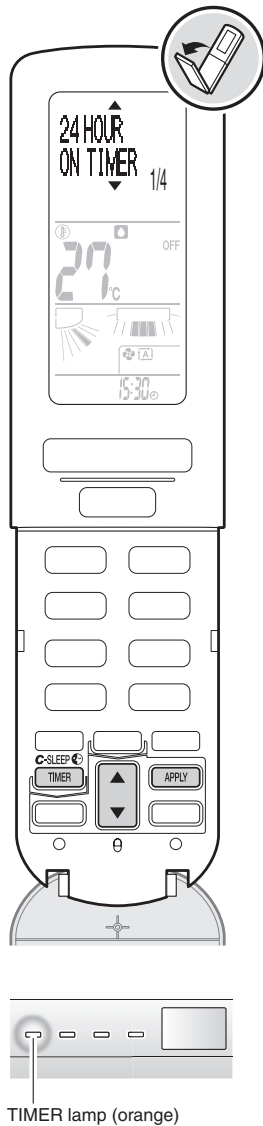

ON/OFF TIMER operation

This function controls the operation start and stop time.
When you set the timer, you can select the operation frequency either once or daily.

< To use the operation >

1. Press .

2. Press to select the item and press .

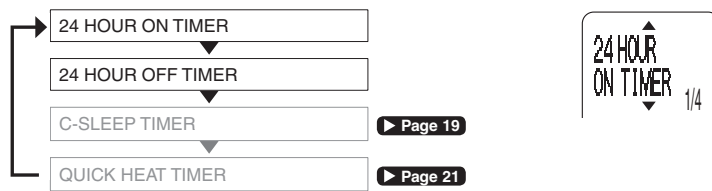

3. Press to select the item and press .

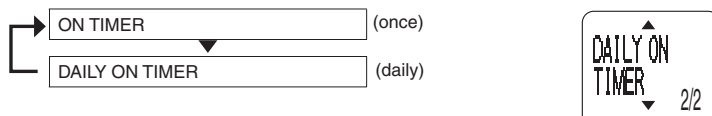

4. Press to set the start/stop time and press .

- The time that was set last is displayed (from the second time).
- Each time you press , the time changes by 10 minutes. If you press and hold the button, the time changes continuously.
- After setting, the set time and "ON" or "OFF" are displayed on the LCD. When daily is selected, "DAILY" is displayed on the LCD as well.
- The TIMER lamp (orange) lights up.



< To change or cancel the setting >

1. Follow steps 1 and 2 above and then select the TIMER you want to change.

2. Press to select the item and press .



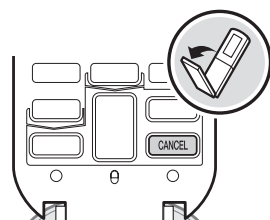
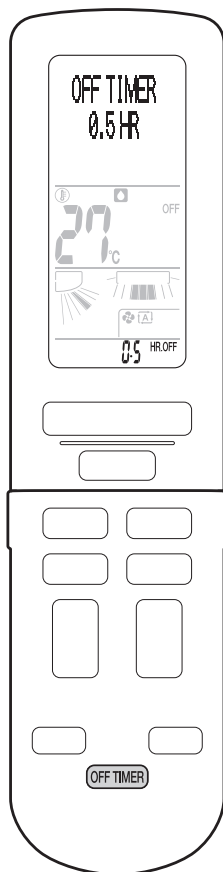

COUNTDOWN OFF TIMER operation

You can set the timer for the remaining time until the scheduled stop.
The timer should be set each time.

< To use the operation >

Press **OFF TIMER**.

- The time can be set in increments of 30 minutes each time the button is pressed (from 30 minutes to 9 hours 30 minutes).

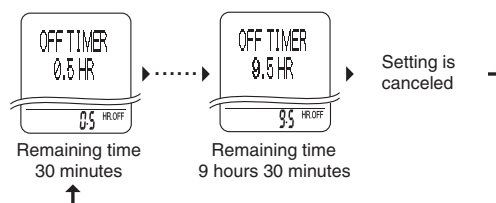

- “OFF” and remaining time until the scheduled stop are displayed on the LCD.
- The TIMER lamp (orange) lights up.

< To cancel the setting >

Press **OFF TIMER** until the setting is canceled.

- The TIMER lamp goes out.

< To combine ON and OFF / COUNTDOWN OFF TIMER operation >

You can combine the ON and OFF / COUNTDOWN OFF TIMERS.

Example

Current time: 23:00 (Air conditioner is operating.)

- OFF TIMER is set to 0:00 (or COUNTDOWN OFF TIMER is set to turn off the unit after 1 hour).
- ON TIMER is set to 7:00.

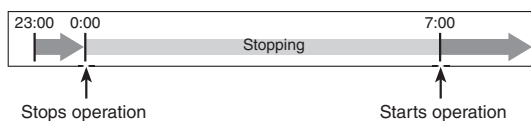

< To cancel all TIMER settings >

Press **CANCEL**.

- The TIMER lamp goes out.
- If the menu screen is open, press **CANCEL** twice.

Notes on TIMER operation

- If the COUNTDOWN OFF TIMER and OFF TIMER (once) are set simultaneously, priority is given to the timer set later.
- If you do not use the air conditioner for a long time, cancel the daily timer.
- If you change the frequency of the timer operation, cancel the present timer setting first and then set the timer again.
- When the TIMER lamp blinks, clean the streamer unit. ▶ [Page 36](#)
- In the following cases, set the timer again. (The timer is reset.)
 - Power failure.
 - The circuit breaker has been activated.
 - The circuit breaker has been turned off.
 - Batteries of the remote controller have been replaced.

To ensure a comfortable sleep

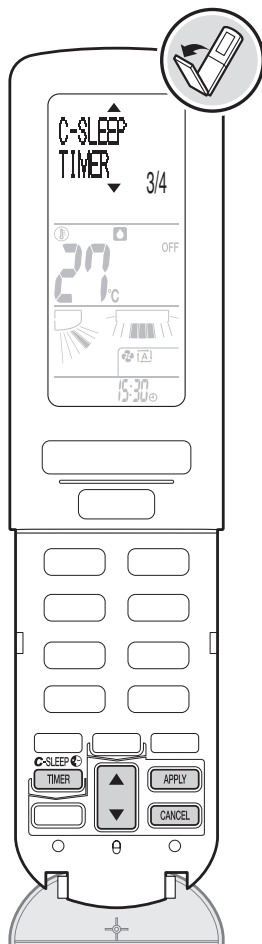

COMFORT SLEEP TIMER operation

COMFORT SLEEP TIMER operation keeps the indoor temperature and humidity at suitable levels for a comfortable sleep and refreshing morning.



< To use the operation >

1. Press  during COOLING or HEATING operation.

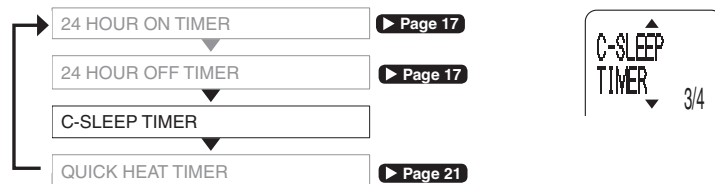
2. Press  to select the item and press .



3. Press  to set the wake-up time and press .

- The time that was set last is displayed (from the second time).
- Each time you press , the time changes by 10 minutes. If you press and hold the button, the time changes continuously.
- When this timer is set, the wake-up time and "

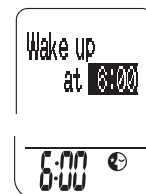



< To change or cancel the setting >

1. Follow steps 1 and 2 above and then select the TIMER you want to change.

2. Press  to select the item and press .



- Settings can be cancelled with .
- If the menu screen is open, press  twice.

Notes on COMFORT SLEEP TIMER operation

- When COMFORT SLEEP TIMER is set, the upper limit of the set temperature of HUMID HEATING is 22°C.
- After the COMFORT SLEEP TIMER operation is finished, the operation displayed on the remote controller will continue.
- If you set the COMFORT SLEEP TIMER while the ON TIMER is set, the ON TIMER will be cancelled.

< Temperature control of COMFORT SLEEP TIMER operation >

- Once COMFORT SLEEP TIMER operation starts, the temperature will be lowered 2°C in the next 3 hours, and then raised 1°C one hour before you wake up. (V-shaped temperature control)

Example (for 6 hours of sleep)

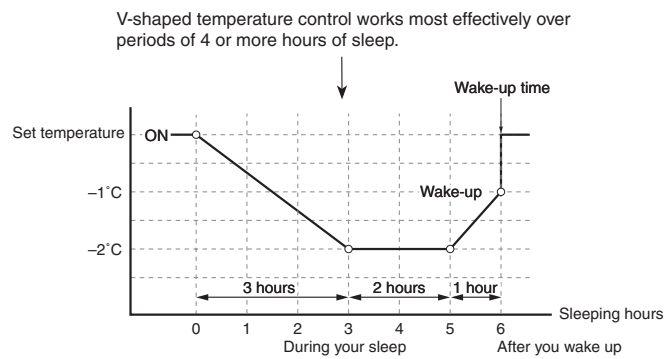

< Humidity control of COMFORT SLEEP TIMER operation >

- In DRY COOLING and HUMID HEATING operations, humidity is controlled based on the standard humidity. Standard humidity is the humidity determined by operation mode and set temperature. ("STD" is displayed on the LCD.)
- When the preset humidity is "MOISTURISING", humidity is constantly controlled on a higher level. ("☺" is displayed on the LCD.)
- In COOLING and HEATING operations, the humidity is not controlled.

Example (for 6 hours of sleep)

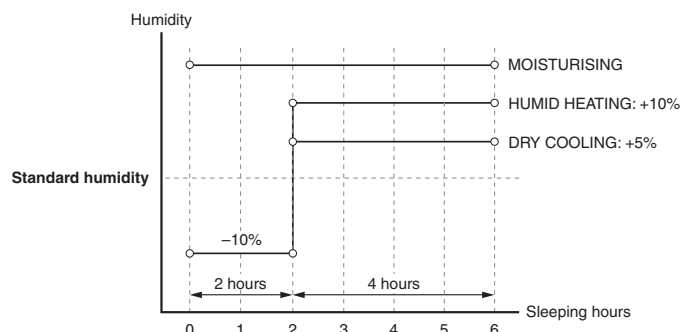

To guarantee high heating capacity when you wake up

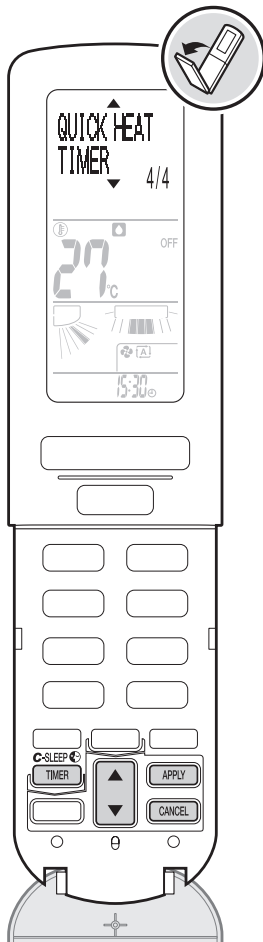

QUICK HEATING TIMER operation

This operation quickly blows warm air when the HEATING operation starts in the morning and makes a warm space (warmth zone) around the indoor unit.

How to set the QUICK HEATING TIMER

1. Press **C-SLEEP** **TIMER**.

2. Press **▲** to select the item and press **APPLY**.



3. Press **▲** to set the QUICK HEATING time and press

APPLY.

- Each time you press **▲**, the time changes by 10 minutes. If you press and hold the button, the time changes continuously.
- QUICK HEATING TIMER is set.
- The QUICK HEATING TIMER lamp (dark red) lights up.



4. Press **OFF** to stop the operation.

When the operation stops, defrosting operation automatically starts. (night defrosting)

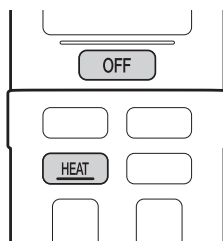

What happens in the morning?

The air conditioner starts warming up about 30 minutes before the set QUICK HEATING time. (preparatory heating operation)
The QUICK HEATING TIMER lamp (dark red) becomes brighter for a duration of about 30 minutes before and after the set QUICK HEATING time.

5. Confirm that the QUICK HEATING TIMER lamp (bright red) is illuminating and then press **HEAT**.

- The QUICK HEATING TIMER operation is performed for about 30 minutes.
- The OPERATION lamp (green) lights up.
- If **HEAT** is not pressed, the preparatory heating operation will stop after about 30 minutes of QUICK HEATING time.





About 30 minutes later, the air conditioner starts the normal HEATING operation.

< To change or cancel the setting >

1. Follow steps 1 and 2 on page 21 and then select the timer setting you want to change.

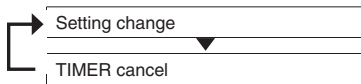
2. Press  to select the item and press .



- Settings can be cancelled with .
- If you cancel the QUICK HEATING TIMER operation halfway through, the operation goes back to the normal HEATING operation. Pressing  also goes back to the normal HEATING operation.





< To stop the operation >

Press .

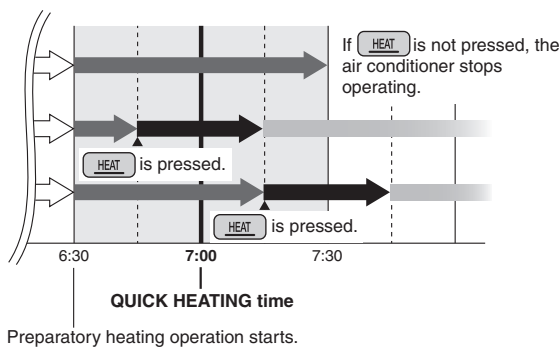
Example

QUICK HEATING time is set to 7:00.



	QUICK HEATING TIMER is set. (QUICK HEATING TIMER lamp (dark red) lights up.)
	Preparatory heating operation is running. (QUICK HEATING TIMER lamp (bright red) lights up.)
	QUICK HEATING TIMER operation is running. (QUICK HEATING TIMER lamp (bright red) and OPERATION lamp (green) light up.)
	Normal HEATING operation is running. (OPERATION lamp (green) lights up.)

Notes on warmth zone

- By blowing warmer air than the normal setting at a lower airflow rate, a warmth zone is created around the indoor unit.
- This function is effective within about 1.5m or less from the wall where the indoor unit is installed.

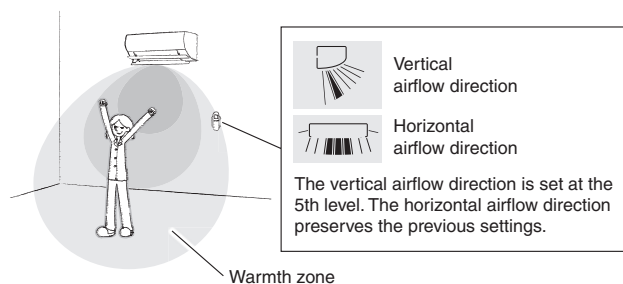

Notes on QUICK HEATING TIMER operation

- To blow warm air quickly, preparatory heating operation is performed for about 30 minutes before and after the set QUICK HEATING time. In this step, electric power is consumed.
- During the preparatory heating operation the flaps open and the fan starts rotating. Also warm air may be blown.
- If you go out and do not use the air conditioner for a long time, cancel the QUICK HEATING TIMER.
- Warm air may be blown at a later stage just after the QUICK HEATING TIMER lamp becomes red or when the protection control works.
- When the indoor temperature is 20°C or higher, or when the outdoor temperature is 16°C or higher, the preparatory heating operation does not start.
- "URURU" HUMIDIFY operation is not performed while the QUICK HEATING TIMER operation is performed.

To increase the cooling or heating power

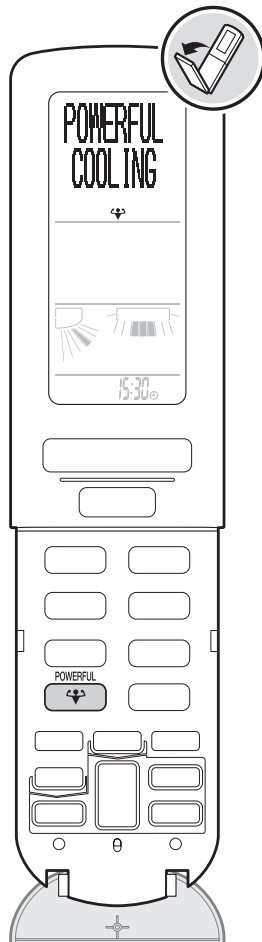

POWERFUL operation

POWERFUL operation quickly maximises the cooling/heating effect. You can get the maximum capacity.

< To use the operation >

Press  **during COOLING or HEATING operation.**

- When POWERFUL operation is set, the operation mode will be changed as follows.

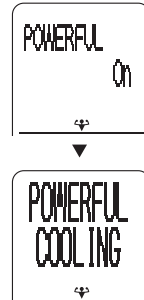

COOLING / DRY COOLING	▶	POWERFUL COOLING (set temperature 18°C)
HEATING / HUMID HEATING	▶	POWERFUL HEATING (set temperature 30°C)

- “” is displayed on the LCD.
- POWERFUL operation ends in 20 minutes. Then the system automatically operates again with the previous settings which were used before POWERFUL operation.
- Temperature and airflow rate cannot be changed.



< To cancel the operation >

Press  **again.**

- “” disappears from the LCD.
- The operation mode returns to the previous setting.
- POWERFUL operation is cancelled when **OFF**, the direct operation buttons,  or  is pressed.

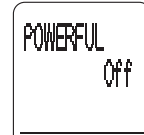

Notes on POWERFUL operation

- The unit's operating sound becomes louder during operation.
- You may not feel sufficient warmth for a while after the operation starts because this operation supplies a higher airflow rate than the normal HEATING operation and the blown air temperature may be lower.
- When using POWERFUL operation, there are some functions which are not available.
- POWERFUL operation will not increase the capacity of the air conditioner if the air conditioner is already in operation with its maximum capacity demonstrated.
- To maximize the cooling/heating effect, the capacity of outdoor unit is increased and the airflow rate is fixed to the maximum setting.

To purify the air in the room

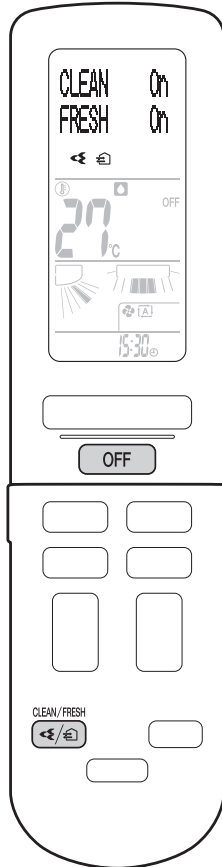

FLASH STREAMER AIR PURIFYING operation

Flash streamer discharge decomposes mold and allergic substances to clean the air in the room.



FRESH AIR SUPPLY VENTILATION operation

The air in the room is cleaned, taking in fresh air from outside.



< To use the operation >

Press .

- Each time you press the button, the setting changes.

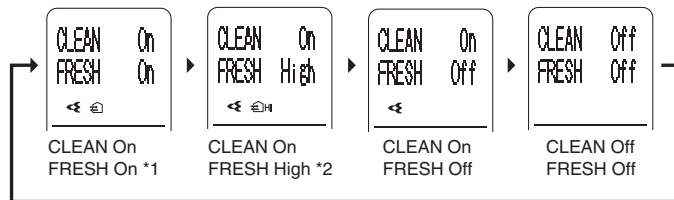

*1 Ventilation is performed at an automatically adjusted airflow rate.

*2 Ventilation is performed at a high airflow rate.

- “←”, “←HI”, or “←” is displayed on the LCD.
(These symbols are not displayed while the unit is not operating.)

< To stop the operation >

Press .

< To cancel the setting >

Press and select “Off”.

- “←”, “←HI”, or “←” disappears from the LCD.
- The operation mode returns to the previous setting.

Note on FLASH STREAMER AIR PURIFYING operation

- When the airflow becomes weak during operation, the streamer discharge may stop temporarily to prevent a small amount of ozone smell coming from the air outlet.

Notes on FRESH AIR SUPPLY VENTILATION operation

- Sounds from outdoors may be heard or odours may be taken in. Also, the unit's operating sound becomes a little louder.
- The unit's operating sound may be different depending on the outdoor temperature and humidity.

To consider the environment of use

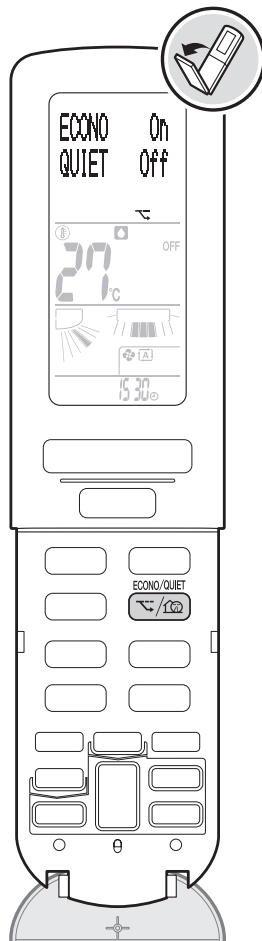

ECONO operation

ECONO operation enables efficient operation by limiting the maximum power consumption value. This function is useful for ensuring a circuit breaker does not trip when the unit runs alongside other appliances.

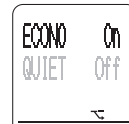

OUTDOOR UNIT QUIET operation

OUTDOOR UNIT QUIET operation lowers the noise level of the outdoor unit by changing the frequency and fan speed on the outdoor unit. This function is useful when you need to consider minimizing noise in your neighbourhood, such as during the night.



< To use the operation >

- Press  during operation and select the setting of your preference.

- Each time you press the button, the setting changes.

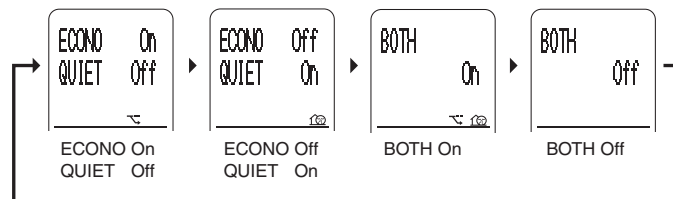

- ", ", or "

< To cancel the operation >

- Press  and select "Off".

- ", ", or "

Notes on the settings of ECONO and OUTDOOR UNIT QUIET in each operation mode

Mode	ECONO	OUTDOOR UNIT QUIET
AUTO / COOLING / DRY COOLING / HEATING / HUMID HEATING	✓	✓
"SARARA" DRY	✓	–
"URURU" HUMIDIFY / FAN ONLY	–	–

Notes on ECONO operation

< Image of running current and power consumption in ECONO operation >

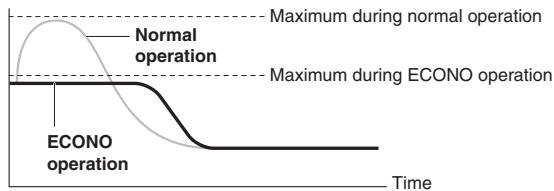

The maximum running current and power consumption of the air conditioner in ECONO operation vary with the connecting outdoor unit.

From start up until set temperature is reached

- Pressing **OFF** causes the settings to be cancelled, and “” disappears from the LCD.
- If the level of power consumption is already low, ECONO operation will not lower the power consumption.
- POWERFUL and ECONO operation cannot be used at the same time. Priority is given to the function of whichever button is pressed

Notes on OUTDOOR UNIT QUIET operation

- POWERFUL operation and OUTDOOR UNIT QUIET operation cannot be used at the same time. Priority is given to the function of whichever button is pressed last.
- Even when operation is stopped with **OFF** or indoor unit ON/OFF switch, “” will remain on the remote controller display unless the settings are cancelled.
- OUTDOOR UNIT QUIET operation will lower neither the frequency nor fan speed if they have already been lowered enough.

To keep the air conditioner clean

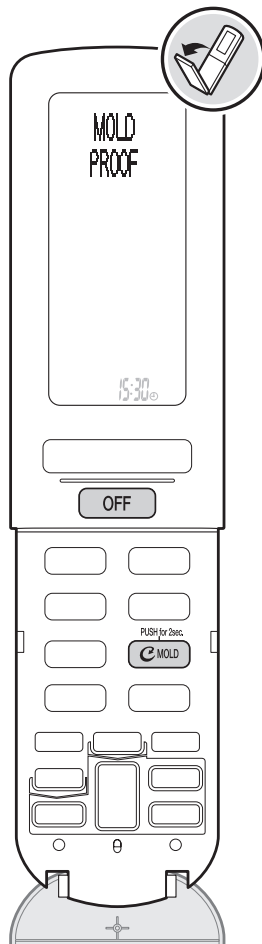

MOLD PROOF / CLEANING FILTER lamp (green)

Ⓒ MOLD PROOF operation

The inside of the air conditioner is dried to reduce the occurrence of mold and odour. When COOLING, "SARARA" DRY, or DRY COOLING operation is performed, condensation may occur inside the air conditioner and may cause mold or odour. It is recommended to dry the inside of the air conditioner by MOLD PROOF operation.

< To automatically operate: Default "Off" >

Press  for about 2 seconds during operation.

- "Ⓒ" is displayed on the LCD.
- MOLD PROOF operation automatically dries the inside of the air conditioner each time after the COOLING, "SARARA" DRY, or DRY COOLING operation is stopped.
- The MOLD PROOF / CLEANING FILTER lamp (green) lights up.
- The operation stops automatically in 100 minutes.

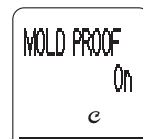

< To cancel the setting >

Press  again for about 2 seconds.

- "Ⓒ" disappears from the LCD.

< To manually operate >

Press  for about 2 seconds while the unit is not operating.

- "MOLD PROOF" is displayed on the LCD, and the display returns to normal after a while.
- The MOLD PROOF / CLEANING FILTER lamp (green) lights up during the operation.
- The operation stops automatically in 100 minutes.



< To cancel the operation halfway through >

Press .

- The MOLD PROOF / CLEANING FILTER lamp goes out.

Notes on automatic operation



■ COOLING / "SARARA" DRY / DRY COOLING operation is running.

■ MOLD PROOF operation is running.

- After COOLING, "SARARA" DRY, or DRY COOLING operation stops, the air conditioner starts the MOLD PROOF operation automatically, and then stops automatically in 100 minutes.
- Even when COOLING is selected in the AUTO operation, the AUTO MOLD PROOF operation is started when the AUTO operation is stopped.
- If the operation is turned off by COUNTDOWN OFF TIMER or OFF TIMER, AUTO MOLD PROOF is not performed.

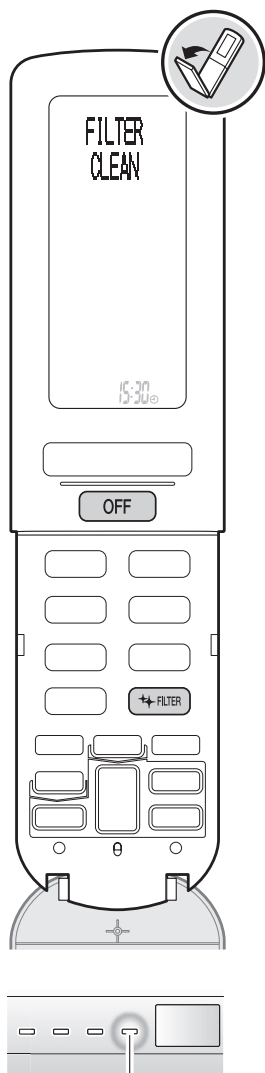

MOLD PROOF / CLEANING FILTER lamp (green)

CLEANING FILTER operation

The air filter will automatically be cleaned.

< To automatically operate: Default "On" >

Press during operation.

- “” is displayed on the LCD.
- The air filter will automatically be cleaned according to the operating hours (about once per day).
- The CLEANING FILTER operation time is a maximum of 11 minutes.
- The MOLD PROOF / CLEANING FILTER lamp (green) lights up during the operation.



< To cancel the setting >

Press again.

- “” disappears from the LCD.

< To manually operate >

Press while the unit is not operating.

- “FILTER CLEAN” is displayed on the LCD, and the display returns to normal after a while.
- The MOLD PROOF / CLEANING FILTER lamp (green) lights up during the operation.



< To cancel the operation halfway through >

Press .

- The MOLD PROOF / CLEANING FILTER lamp goes out.

Notes on automatic operation

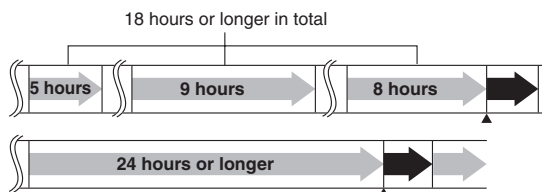

Air conditioner is operating.

CLEANING FILTER operation is running.

- CLEANING FILTER operation starts when you stop the unit after operating it for about 18 hours or longer.
- After the air conditioner has continued to operate for 24 hours or longer, the operation is suspended and the CLEANING FILTER operation is started. After cleaning is completed, the air conditioner restarts (including 24 HOUR FRESH AIR SUPPLY VENTILATION).

Page 34

To keep the air conditioner clean

Notes on MOLD PROOF operation

- This operation dries the inside of the air conditioner with the FAN ONLY and HEATING operation.
- This operation dries the inside of the air conditioner while streamer discharge is performed to reduce the development of mold and odour inside the air conditioner. But the function does not remove any adhered dust and mold.
- The HEATING operation will not start when the outdoor temperature is 24°C or higher or the indoor temperature is higher.
- The flaps may sometimes close to increase the drying effect inside the air conditioner.
- **When the MOLD PROOF / CLEANING FILTER lamp blinks, clean the dust box and reset the dust box cleaning indicator.**

▶ Page 37

Notes on CLEANING FILTER operation

- In this operation, dust is collected in the dust box.
- In an environment where oil or nicotine is attached to the air filter, the filter may not be completely cleaned by the CLEANING FILTER operation, and you may need to clean the air filter by yourself.
- You can remove the air filters and clean them manually as well. ▶ Page 38
- When the indoor temperature is lower than 10°C, the CLEANING FILTER operation will not start to protect the air filters.
- The CLEANING FILTER operation after the "URURU" HUMIDIFY, HUMID HEATING, or FRESH AIR SUPPLY VENTILATION operation may become longer than usual to protect the air conditioner.
- If the AUTO CLEANING FILTER is set to "Off", **the filter may not be completely cleaned unless you perform the CLEANING FILTER operation on a daily basis.**
- **When the MOLD PROOF / CLEANING FILTER lamp blinks, clean the dust box and reset the dust box cleaning indicator.**

▶ Page 37

< Relation between CLEANING FILTER operation and the indoor unit lamp >

Air conditioner	CLEANING FILTER operation	MOLD PROOF / CLEANING FILTER lamp
Operating	Automatic "On"	Goes out *1 *2
	Automatic "Off"	Goes out *2
Not operating	Automatic "On", operating	Lights up
	Automatic "Off", operating	Lights up
	Automatic "On / Off", not operating	Goes out

*1 When AUTO CLEANING FILTER operation is started after the unit has continued to operate for 24 hours or longer, the MOLD PROOF / CLEANING FILTER lamp will light up.

*2 If the AUTO MOLD PROOF is set to "On", the lamp will light up.

To know the status of your room and air conditioner

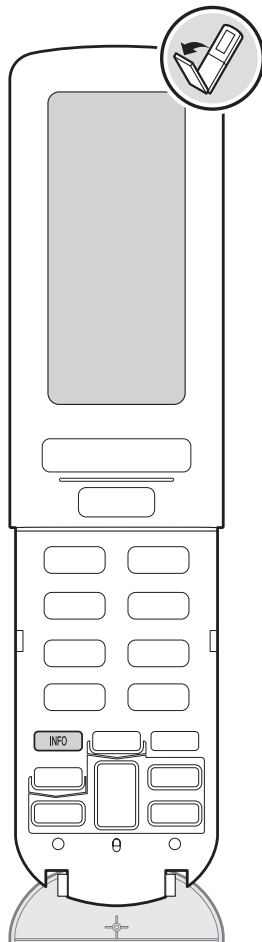

INFORMATION

The indicator displayed on the LCD gives information about temperature, power consumption, and so on.

The indicated indoor and outdoor temperatures are measured near the indoor and outdoor units.

The indicator should be used as a guide only.

< To see the information >

➤ **Direct the remote controller toward the indoor unit and press **INFO**.**

- Keep directing the remote controller toward the indoor unit for about 2 seconds.
A signal is received from the indoor unit.
- Each time you press the button, the information changes.

LCD example

When the indoor temperature is 30°C during DRY COOLING operation.

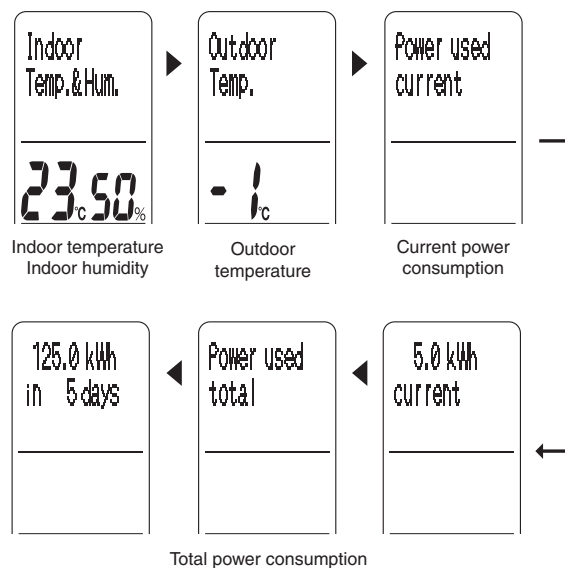

Notes on INFORMATION

- The total power consumption is displayed up to 9,999kWh. When the total power consumption exceeds 9,999kWh, the indicator shows 0kWh. Also, if the total number of days that the unit is used exceeds 999, the indicator shows 0 days. (The displayed number of days is the total time that the power to the unit is on.) Please use these indications as a guide.
- The power consumption is displayed in increments of 0.1kWh up to 50kWh and in increments of 1kWh after 50kWh.
- The indoor and outdoor temperatures are indicated by estimating the temperatures near the indoor and outdoor units based on the temperatures detected by the sensor attached to the indoor and outdoor units.
- If the signals from the remote controller do not properly reach the indoor unit, the setting displayed on the LCD may be different from the actual operation of the indoor unit. If you press **INFO** in that condition, the operation of the indoor unit will be changed according to the setting on the remote controller.
- If **INFO** is pressed when the outdoor temperature cannot be detected such as when the unit is stopped, the outdoor temperature is displayed as "--". In this case, press **INFO** again.
- Indoor and outdoor temperatures between -9°C and 39°C can be displayed.

To change the default settings

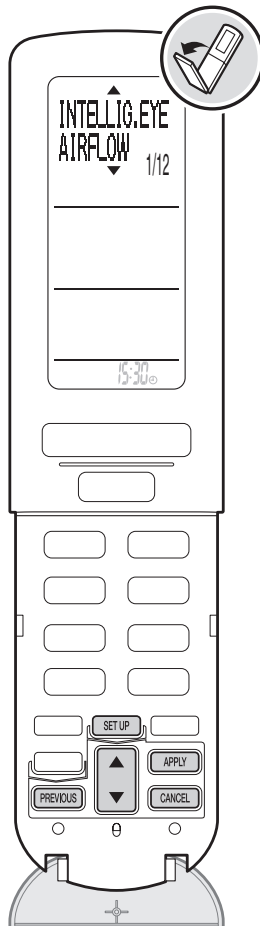

Menu settings

You can change the default settings according to your room's environment and your taste.

< To change the setting >

Press **SET UP**.

Press **▲** to select the item and press **APPLY**.

No.	Menu items	Page
1	INTELLIG.EYE AIRFLOW	32
2	AUTO OFF time	32
3	BREEZE AIRFLOW	32
4	HUMIDIFY AIRFLOW	32
5	CONTINUE DRY	33
6	INSTALLED POSITION	33
7	RESET USED POWER	33
8	SOUND VOLUME	33
9	CONTRAST	34
10	24 HOUR FRESH AIR	34
11	RC ADDRESS	34
12	CHILD LOCK	34

Press **▲** to select each setting and press **APPLY**.

- To set 24 HOUR FRESH AIR, RC ADDRESS, or CHILD LOCK, press for about 2 seconds.
- When the setting is completed, the menu screen is displayed again (except when setting CHILD LOCK).
- The menu screen will return to the original screen if no operation is made for about 1 minute.

< To return to the previous display >

Press **PREVIOUS**.





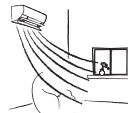
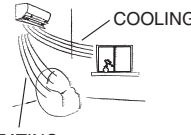



< To exit the menu settings >

Press **CANCEL**.

No.	Menu	Setting	Description
1	INTELLIG.EYE AIRFLOW	Focus	The INTELLIGENT EYE sensor detects an area where there is a person and adjusts the horizontal airflow direction to blow air directly on the person.
		Comfort*	The INTELLIGENT EYE sensor detects an area where there is a person and adjusts the horizontal airflow direction to avoid blowing air directly on the person.
<p>< Note ></p> <p>■ Focus</p> <ul style="list-style-type: none"> The vertical airflow direction is adjusted so that the maximum airflow rate is achieved. <p>■ Comfort</p> <ul style="list-style-type: none"> The unit blows air upward in the COOLING operation and downward in the HEATING operation. <div style="display: flex; justify-content: space-around; align-items: center;">   </div>			
2	AUTO OFF time	1 HR *	<p>Sets the time for stopping the operation to after 1 hour or after 3 hours.</p> <ul style="list-style-type: none"> This function is not activated during the following operations. <div style="border: 1px solid black; padding: 5px; width: fit-content; margin: 5px auto;"> MOLD PROOF, QUICK HEATING TIMER and CLEANING FILTER operation </div> <p>This function will be activated after the end of each operation.</p> <ul style="list-style-type: none"> This function is not totally activated if the 24 HOUR FRESH AIR SUPPLY VENTILATION is set.
		3 HR	
<p>< Note ></p> <ul style="list-style-type: none"> This function changes the set temperature +2°C in COOLING / -2°C in HEATING and the operation stops after the preset time elapses if it is judged that no one is in the room. 3 minutes before the operation stops, the OPERATION lamp blinks to lower the airflow rate. After that, the operation stops. In this mode, the operation stops automatically. It is recommended to set the AUTO OFF operation to "Off" if a small child or a sick person is in the room. (If a person does not move much, the sensor judges that no one is in the room and the air conditioner may be stopped.) If the operation has been stopped by AUTO OFF operation, the LCD will not show "OFF" 			
3	BREEZE AIRFLOW	Auto *	Sets the BREEZE AIRFLOW rate to "Auto".
		Low	Sets the BREEZE AIRFLOW rate to "Low".
<p>< Note ></p> <ul style="list-style-type: none"> This function sets the airflow rate when the vertical airflow direction is set to "BREEZE". If you are disturbed by the unit's operating sound, set it to "Low". 			
4	HUMIDIFY AIRFLOW	Auto *	Sets the humidified airflow rate to "Auto".
		High	Sets the humidified airflow rate to "High".
		Low	Sets the humidified airflow rate to "Low".
<p>< Note ></p> <ul style="list-style-type: none"> This function sets the humidified airflow rate in the "URURU" HUMIDIFY and HUMID HEATING operations. To increase the humidified airflow rate, set it to "High" and if you are disturbed by the sound of the humidifying operation, set it to "Low". 			

* Default setting

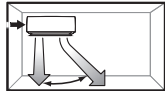
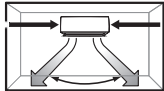
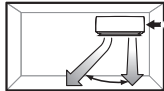
To change the default settings

No.	Menu	Setting	Description
5	CONTINUE DRY	On *	CONTINUE DRY operation is performed.
		Off	CONTINUE DRY operation is not performed.
<p>< Note ></p> <ul style="list-style-type: none"> When the indoor temperature or humidity falls far below the preset value, the fans of indoor and outdoor units are stopped to keep the room comfortable. This operation is activated in the COOLING, "SARARA" DRY, and DRY COOLING operations. When the CONTINUE DRY is set to "On", starting the COOLING, "SARARA" DRY, or DRY COOLING operation triggers the deodorising function which reduces any unpleasant odour coming from the indoor unit and the unit does not blow air for 40 seconds. Before the outdoor unit operates, the indoor temperature may be higher than the set temperature. 			
6	INSTALLED POSITION	 *	Oblong centre * The horizontal airflow direction blows air evenly to the right and left.
			Oblong right corner The horizontal airflow direction blows air to the left.
			Oblong left corner The horizontal airflow direction blows air to the right.
			Horizontal centre The horizontal airflow direction blows air evenly to the right and left.
			Horizontal right corner The horizontal airflow direction blows air to the left.
			Horizontal left corner The horizontal airflow direction blows air to the right.
<p>< Note ></p> <ul style="list-style-type: none"> Airflow direction is properly controlled by inputting data on the room shape and installation position of the indoor unit in the remote controller. Set oblong or horizontal according to the room shape. If you do not set the right corner and left corner correctly, the airflow direction may not be properly controlled in some airflow settings. The airflow direction range at the horizontal airflow setting (airflow direction that can be selected with ) will change according to the settings for the installation position. <p>< Setting guides ></p> <div style="display: flex; justify-content: space-around; align-items: flex-end;"> <div style="text-align: center;">  <p>When the distance is 2 to 50cm, set to the left corner.</p> </div> <div style="text-align: center;">  <p>When the unit is installed in the centre, set to centre.</p> </div> <div style="text-align: center;">  <p>When the distance is 2 to 50cm, set to the right corner.</p> </div> </div>			
7	RESET USED POWER	Reset with APPLY	Resets the total power consumption to 0kWh.
<p>< Note ></p> <ul style="list-style-type: none"> This function resets the total power consumption. To check the power consumption, press . 			
8	SOUND VOLUME	High	The volume is high.
		Low *	Normal volume.
		Off	The volume is off.
<p>< Note ></p> <ul style="list-style-type: none"> This function sets the volume of the receiving tone of the indoor unit. 			

* Default setting

No.	Menu	Setting	Description
9	CONTRAST	1 to 5	<ul style="list-style-type: none"> You can set the contrast between 1 and 5. The default setting is "3". The higher the figure, the darker the indicator.
		<p>< Note ></p> <ul style="list-style-type: none"> This function sets the contrast of the LCD. 	
10	24 HOUR FRESH AIR	Push APPLY 2sec. On	Starts 24 HOUR FRESH AIR SUPPLY VENTILATION operation.
		Push APPLY 2sec. Off *	Stops 24 HOUR FRESH AIR SUPPLY VENTILATION operation.
<p>< Note ></p> <ul style="list-style-type: none"> Even if you stop the air conditioner with the remote controller, it continues ventilation for 24 hours until you change the setting to "Off". The 24 HOUR FRESH AIR SUPPLY VENTILATION starts itself when the circuit breaker has been turned on. (The OPERATION lamp of the unit is off during the operation. No display is shown on the remote controller.) When the 24 HOUR FRESH AIR SUPPLY VENTILATION is solely operated, the streamer discharge cannot be started. When the AUTO CLEANING FILTER is set to "On" and the normal operation of the air conditioner stops for 24 hours or longer, the 24 HOUR FRESH AIR SUPPLY VENTILATION is terminated and the CLEANING FILTER operation starts (and lasts for about 11 minutes). After the filter has been cleaned, the 24 HOUR FRESH AIR SUPPLY VENTILATION restarts. ▶Page 28 			
11	RC ADDRESS	Push APPLY 2sec. 1 *	<p>The default setting is "1" for both the indoor unit and remote controller.</p> <p>< To set the address to "2" ></p> <ol style="list-style-type: none"> Open the front panel, and turn on the circuit breaker. Press SETUP. Press ▲ to select "RC ADDRESS" and press APPLY. Press ▼ to select "2". Press APPLY for 2 seconds and send a signal to the indoor unit. The OPERATION lamp (green) blinks for about 1 minute. (This is not an error blink.) Press the indoor unit ON/OFF switch while the OPERATION lamp is blinking.
		Push APPLY 2sec. 2	
<p>< Note ></p> <ul style="list-style-type: none"> This function sets the address when you install 2 indoor units in the same room and do not want to operate them with 1 remote controller. When you set one of the indoor units and one of the 2 remote controllers to "2", the set remote controller can send a signal only to the set indoor unit. 			
12	CHILD LOCK	Push APPLY 2sec. On	Press APPLY for about 2 seconds to activate the child lock function.
		Push APPLY 2sec. Off	Press APPLY for about 2 seconds to cancel the child lock function.
<p>< Note ></p> <ul style="list-style-type: none"> This function prevents children from operating the remote controller by mistake. 			
 <p>is displayed and the buttons except SETUP is disabled.</p>			

* Default setting

Cleaning (for service personnel)

⚠ CAUTION

- Be sure to stop the operation and turn off the circuit breaker before cleaning.
- For care and cleaning, call service personnel.

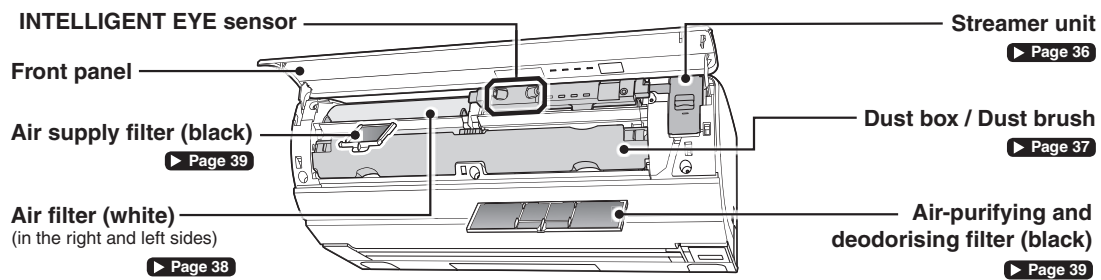

Front panel

When?

When you find dirt or dust.

How?

- Wipe gently with a soft cloth moistened with water or neutral liquid detergent.
- Make sure to clean the back of the front panel.

⚠ CAUTION

- When removing and attaching the front panel, stand on a solid, stable base and take care not to fall.
- When removing and attaching the front panel, support the panel securely with your hands to prevent it from falling.

Removing the front panel

1. Turn off the circuit breaker.
2. Hold the panel at both ends and open until the panel stops.

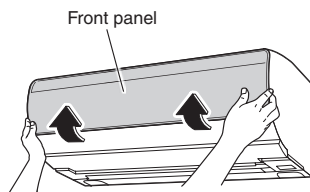

- Pushing further up from the stopping position allows the panel to be removed more easily.

3. Remove the front panel.

- While pushing the left-side front panel shaft outward, push up the front panel and remove it. (Remove the right-side front panel shaft in the same manner.)
- After removing both front panel shafts, pull the front panel toward yourself and remove it.

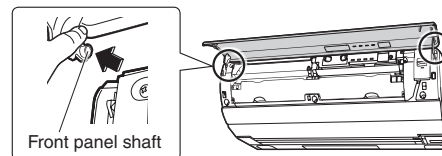

Attaching the front panel

1. Insert the right and left front panel shafts on the front panel into the shaft holes one at a time.

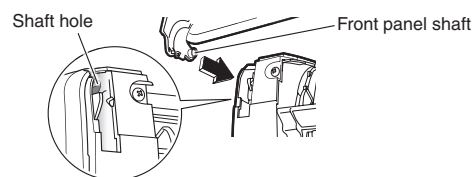

2. Close the front panel slowly and press on both sides of the front panel.

Confirm that the front panel is securely installed.

Indoor unit / INTELLIGENT EYE sensor

When?

When you find dirt or dust.

How?

- Wipe gently with a soft, dry cloth.
- Make sure to clean the lens part of the INTELLIGENT EYE sensor.

CAUTION

- Do not touch the aluminium fins of the indoor unit. (It may cause an injury.)
- Do not use the following to clean the air conditioner. (It may cause deformation, discolouration or scratches.)
 - Water hotter than 40°C
 - Volatile liquid such as benzene, petrol and thinner
 - Polishing compound
 - Rough materials such as scrubbing brush

Streamer unit

When?

When the **TIMER lamp (orange)** blinks or once in a season.

The **TIMER lamp** blinks to indicate that the streamer unit needs cleaning when the total operation time of the air conditioner exceeds 1,800 hours. (**Streamer unit cleaning indicator**) Clean the streamer unit.

Streamer discharge is disabled while the lamp is blinking.

How?

- 1) Soak the streamer unit in lukewarm water or cold water (for about 1 hour).
- 2) Use a cotton bud or soft cloth to clean the unit. (**Wear rubber gloves.**)
- 3) Wash the unit with running water and drain it thoroughly.
- 4) Dry the unit in a well-ventilated shady area (for about 1 day).

Reset the indicator after cleaning.

Turn on the circuit breaker, and press **RESET** and then **APPLY** while the air conditioner is not operating. ▶ **Page 8**

- The streamer unit cleaning indicator goes out.

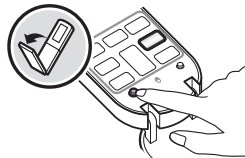

If dust adheres to the needles

Gently wipe the dust from the needles with a soft material such as a cotton bud, moistened with water or neutral liquid detergent. When wiping dust off, be careful not to deform the needles. A deformed needle will lower the deodorisation ability.

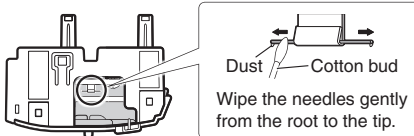

Removing the streamer unit

- **Hold the grip of the streamer unit and pull it toward yourself.**

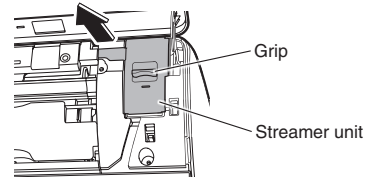

Attaching the streamer unit

- **Insert the streamer unit all the way in.**

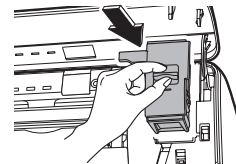

Attention

- If you cannot remove dirt or dust completely, add neutral liquid detergent to lukewarm water or cold water and soak the filter in it.
- Follow the instructions regarding neutral liquid detergent when you use it. Wash the streamer unit thoroughly with water after using detergent to remove any residue.
- Be careful not to leave any lint on the streamer unit. (Lint may cause the unit to malfunction.)
- Do not disassemble the streamer unit.

Cleaning (for service personnel)

Dust box / Dust brush

When?

When the **MOLD PROOF / CLEANING FILTER lamp** (green) blinks.



The **MOLD PROOF / CLEANING FILTER lamp** blinks to indicate that the dust box needs cleaning when there is dust in the dust box or when the dust brush gets dirty with the **CLEANING FILTER** operation (automatic or manual). (**Dust box cleaning indicator**) Clean the dust box.

CLEANING FILTER operation cannot be performed while the lamp is blinking.

How?

- Use a vacuum cleaner to remove dust or wash with water.
- If you have washed the dust box with water, dry it well in the shade.

Reset the indicator after cleaning.

Turn on the circuit breaker, and press  and then  while the air conditioner is not operating. **▶ Page 8**

- The dust box cleaning indicator goes out.

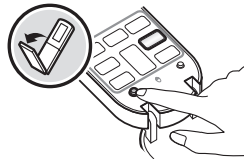

Removing the dust box

1. Slide the right and left fixing tabs (blue) inwards and slowly pull the dust box out with both hands.

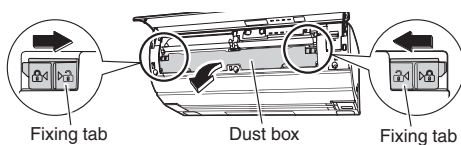

2. Open the dust box.

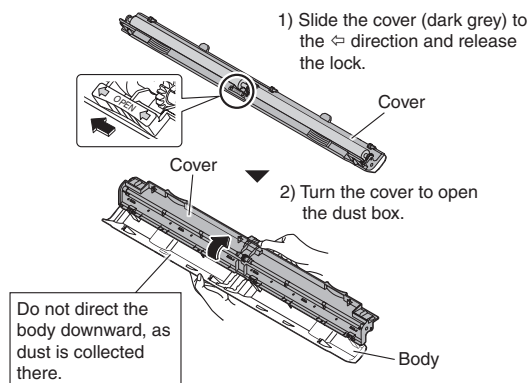

< Removing or attaching the dust brush >

- 1) Pull the centre of the dust brush.
- 2) Take out the dust brush from the right-side and left-side shaft holes.
- 3) Pull out the dust brush.

For installation, attach the dust brush to the shaft holes, and push it in the dust box.

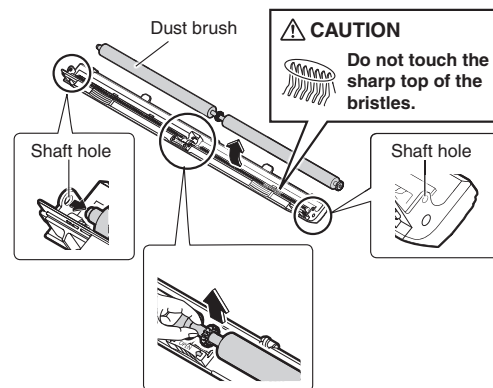

Confirm that the dust brush is securely attached. Otherwise, the dust brush may not rotate and the **CLEANING FILTER** operation may not be performed.

Attaching the dust box

1. Close the dust box, and then slide the cover to lock the dust box.

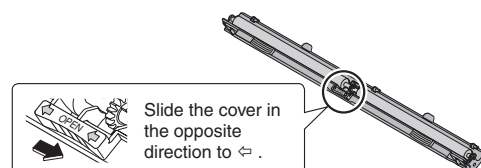

2. Hold the dust box with both hands and attach it in the unit so that the dust brush faces the air conditioner side.

3. Slide the fixing tabs at both ends outwards.

CLEANING FILTER operation will not be correctly performed if the tabs are not securely locked.

When you clean the filters, open the front panel and remove the dust box.

Air filter (white)

If the AUTO CLEANING FILTER operation is set to "On", basically no care is required. ▶ Page 28
 When you are aware of dirt, such as when oil or nicotine is attached to the air filter or when the AUTO CLEANING FILTER operation is set to "Off", clean the filter.

When?

When you find dirt or dust.

How?

- Use a vacuum cleaner to remove dust.
- If you cannot remove dirt or dust completely, soak the filter in lukewarm water with neutral liquid detergent and clean with a sponge.
- After washing the filter, drain it.
- Smooth the filter by hand and dry it well in the shade.

Attention

- Do not disassemble the air filter.

Removing the air filter

1. Pull down the filter holding frame (yellow).

- The tabs of the filter holding frame (yellow) are provided one on each side.

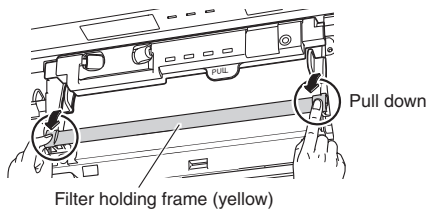

2. Pull out the air filter.

- 1) Hold the PULL tab on the display unit (black), direct the unit upward.
- 2) Raise the grips of the air filter (blue) upward to the front.
- 3) Pull the grips downward.

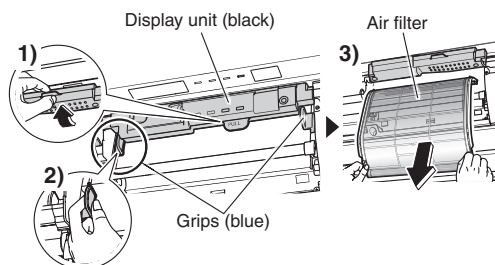

Attaching the air filter

1. Hold the grips (blue) and insert the filter along the rail.

- After attaching the air filter, direct the display unit (black) downward.

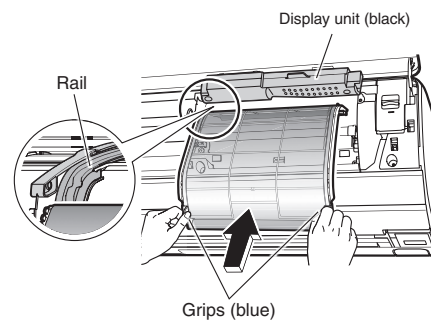

2. Push up the filter holding frame (yellow) until it clicks.

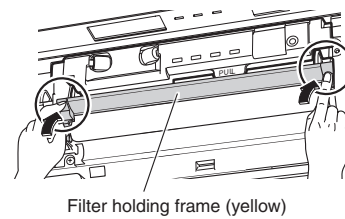

If the frame is not securely locked, the front panel may be damaged.

After cleaning, start the CLEANING FILTER operation to check that the air filter operates correctly. ▶ Page 28

Cleaning (for service personnel)

When you clean the filters, open the front panel and remove the dust box.

Air-purifying and deodorising filter (black)

When?

When you find dust.

How?

- Use a vacuum cleaner to remove dust.

Attention

- Never wash the filter in water.

Removing the air-purifying and deodorising filter

1. Remove the right-side air filter. ▶ Page 38
2. Lift the grip and remove the filter from the tabs.

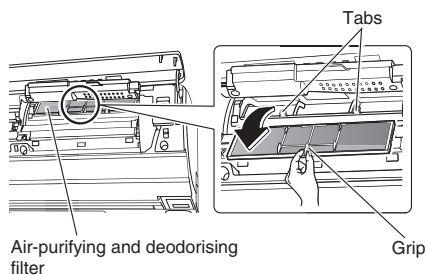

Attaching the air-purifying and deodorising filter

Return the air-purifying and deodorising filter to its position.

- Hang the air-purifying and deodorising filter on the tabs of the air conditioner.

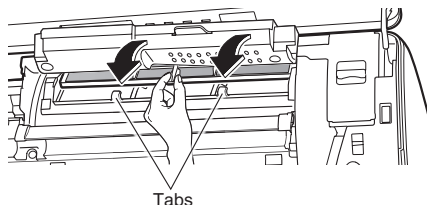

CLEANING FILTER operation will not be performed properly if the air-purifying and deodorising filter is not attached correctly. After cleaning, start the CLEANING FILTER operation to check that the air filter operates correctly. ▶ Page 28

- Dispose of old filters as non-flammable waste.
- To order an air-purifying and deodorising filter, contact the service shop where you bought the air conditioner.

Item	Air-purifying and deodorising filter (with frame) 1 set
Part No.	KAF046A41

Air supply filter (black)

When?

When you find dirt or dust.

How?

- Use a vacuum cleaner to remove dust.
- If you cannot remove dust completely, soak the filter (with the frame) in lukewarm water or cold water for about 10 to 15 minutes and wash it.

Attention

- Do not rub the filter.
- After soaking the air supply filter, drain it and dry it well in the shade.

Removing the air supply filter

1. Remove the left-side air filter. ▶ Page 38
2. Raise the filter holding frame (yellow), hold the grip and pull it to the front.

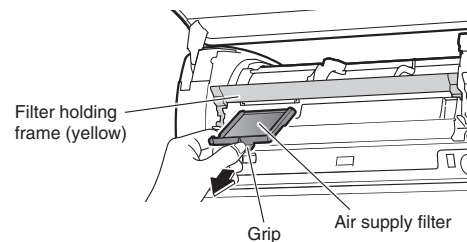

Attaching the air supply filter

Return the air supply filter to its position.

- Direct ▲ on the filter upward and insert the air supply filter until it clicks.

After cleaning, start the CLEANING FILTER operation to check that the air filter operates correctly. ▶ Page 28

When the OPERATION lamp (green) blinks

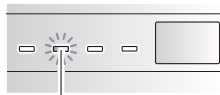

OPERATION lamp (green)

When the TIMER lamp (orange) blinks ▶ Page 36

When the MOLD PROOF / CLEANING FILTER lamp (green) blinks ▶ Page 37

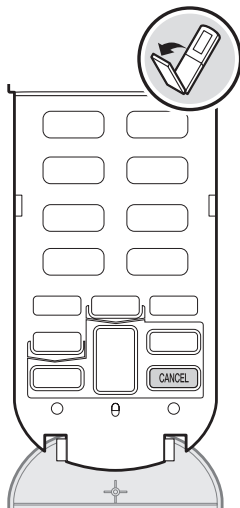

When the OPERATION lamp (green) blinks, turn off the circuit breaker. After about 1 minute, turn it on again and start operation.

If the OPERATION lamp still blinks, check the error code according to the steps below and take appropriate action.

< To check the error code >

1. Direct the remote controller toward the indoor unit and press **CANCEL for about 5 seconds.**

- An error code is displayed on the LCD.

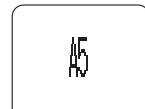

2. Check the error code and take the action described below.

Error code	Check operation and action
A5	Is the air filter soiled or dusty? <ul style="list-style-type: none"> • Stop the operation and start the CLEANING FILTER operation. ▶ Page 28

Turn off the circuit breaker and turn it on again. Then start operation.

E7	Is any foreign object stuck in the outdoor unit fan? <ul style="list-style-type: none"> • Turn off the circuit breaker, and then remove foreign objects.
F3,F6,L3,L4,L5	Is the air outlet of the outdoor unit blocked by a car or the like? <ul style="list-style-type: none"> • Turn off the circuit breaker, and then remove the obstruction.

Turn on the circuit breaker and start operation.

Other error codes	Check the model name (or control code *) and contact the service shop.
-------------------	--

3. Check the OPERATION lamp again and take the action described below.

OPERATION lamp	Action
Lights up	Continue the operation for a while and if the OPERATION lamp does not blink, keep on using the air conditioner.
Blinks again	Check the model name (or control code *) and contact the service shop.

< * To check the control code >

Press **CANCEL again while the error code is displayed on the LCD.**

- A 4-digit control code is displayed on the LCD.
If the model name cannot be checked with the indoor unit, use this control code for the inquiry.

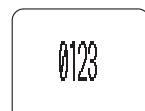

Attention

- When **CANCEL** is pressed for about 5 seconds when the OPERATION lamp is not blinking, "00" is displayed.
- For other possible failures. ▶ Page 41-45

The following error code indicates an error of the humidifying unit or some sensors. Only the COOLING and HEATING operations are available in this case. Contact the service shop as soon as possible.

PH, PA, P9, CC, CA, U7

FAQ

Indoor unit

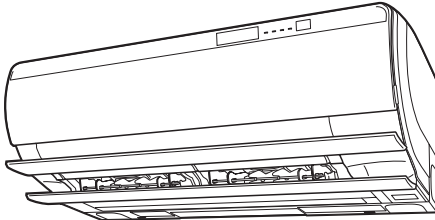

The flaps do not start swing immediately.

- The air conditioner is adjusting the flaps position. The flaps will start moving soon.

The air conditioner stops generating airflow during operation.

- Once the set temperature is reached, the airflow rate is reduced and operation stopped in order to avoid generating cool airflow (during heating) or in order to keep the humidity from rising (during cooling). Operation will resume automatically when the indoor temperature rises or falls.

Operation does not start soon.

- **When AUTO button, direct operation buttons or FAN ONLY button was pressed soon after operation was stopped.**
- **When the mode was reselected.**
 - This is to protect the air conditioner. You should wait for about 3 minutes.

The HEATING operation stops suddenly and a flowing sound is heard.

- The outdoor unit is taking away the frost. The HEATING operation starts after the frost on the outdoor unit is removed. You should wait for about 3 to 10 minutes.

Outdoor unit

The outdoor unit emits water or steam.

- **In HEATING operation**
 - The frost on the outdoor unit melts into water or steam when the air conditioner is in defrost operation.
- **In COOLING or "SARARA" DRY operation**
 - Moisture in the air condenses into water on the cool surface of outdoor unit piping and drips.

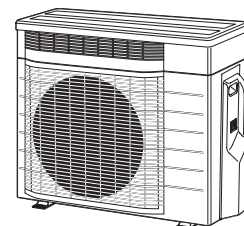

Commonly occurring sounds



- **A hissing sound**
 - This is a sound generated when humidified air or ventilated air is discharged.
 - Operating sound may vary depending on the outdoor temperature or humidity.
- **Roaring sound**
 - This is a sound of ventilating operation. (When ventilating operation is combined with COOLING/HEATING operation, it is possible to stop only ventilating operation.) ▶ Page 24
- **Hissing or cracking sound**
 - This is a sound of streamer discharge.
- **Roaring sound**
 - This is a sound of the dust brush rubbing the air filter to remove dust from the air filter in CLEANING FILTER operation.
- **Clicking sound while the air conditioner is or is not in operation**
 - This is a sound of operation of the electric components or valve that controls the refrigerant.
- **A sound like a flow of water**
 - This is a sound of the refrigerant flowing in the air conditioner.
 - This is a pumping sound of the water in the air conditioner and heard when the water is pumped out from the air conditioner in cooling or drying operation.
- **Blowing sound**
 - This is a sound generated when the direction of the flow of the refrigerant changes in the air conditioner.
- **Ticking sound**
 - This is a sound generated when the air conditioner slightly expands or shrinks due to temperature change.
- **Clopping sound**
 - This is a sound that comes from the inside of the air conditioner when the ventilating fan is operated with the room closed. This sound may decrease when the window is opened or the ventilating fan is stopped.
- **Whistling sound**
 - This is a sound generated when the refrigerant flows during defrosting operation.

Troubleshooting (for service personnel)



Before making an inquiry or a request for repair, check the following.
If the problem persists, consult the service shop.

	<p>Not trouble</p> <p>These cases are not troubles.</p>		<p>Check</p> <p>Please check again before calling a repair person.</p>
---	--	---	---



The air conditioner does not operate

Case	Description / where to check
Operation was started during CLEANING FILTER operation.	 <ul style="list-style-type: none"> The air filter is moving back to the normal position. Wait for up to about 3 minutes.
Operation was started immediately after CLEANING FILTER operation stopped.	
The air conditioner does not operate. [OPERATION lamp is off]	 <ul style="list-style-type: none"> Has the circuit breaker been tripped or the fuse blown? Is it power failure? Are batteries set in the remote controller? Does the address of the indoor unit match that of the remote controller? Set the address again. ▶ Page 34
The air conditioner does not operate. [OPERATION lamp is blinking]	 <ul style="list-style-type: none"> Turn off the power with the circuit breaker and restart operation with the remote controller. If the OPERATION lamp is still blinking, check the error code and consult the service shop. ▶ Page 40

The air conditioner stops operating

Case	Description / where to check
Operation stops suddenly. [OPERATION lamp is on]	 <ul style="list-style-type: none"> For system protection, the air conditioner may stop operating on a sudden large voltage fluctuation. It automatically resumes operation in about 3 minutes.
Operation stops suddenly. [OPERATION lamp is blinking]	 <ul style="list-style-type: none"> Is there anything blocking the air inlet or air outlet of the indoor unit or outdoor unit? Stop operation and after turning off the circuit breaker, remove the obstruction. Then restart operation with the remote controller. If the OPERATION lamp is still blinking, check the error code and consult the service shop. ▶ Page 40

The air conditioner does not stop operating

Case	Description / where to check
The air conditioner continues operating even after COOLING, "SARARA" DRY, or DRY COOLING operation is stopped.	 <ul style="list-style-type: none"> This happens when the unit is in AUTO MOLD PROOF operation. When you want to stop MOLD PROOF operation in the middle, press <input type="button" value="OFF"/>. If the AUTO MOLD PROOF operation does not suit your preference, set the operation to "Off". ▶ Page 27
The air conditioner continues operating even after operation is stopped.	 <ul style="list-style-type: none"> <ul style="list-style-type: none"> Immediately after the air conditioner is stopped <ul style="list-style-type: none"> This happens when defrosting operation (night defrosting) is running. (When QUICK HEATING TIMER is set.) ▶ Page 21 The outdoor unit fan continues rotating for another about 1 minute for system protection. While the air conditioner is not in operation <ul style="list-style-type: none"> When the outdoor temperature is high, the outdoor unit fan may start rotating for system protection. When 24 HOUR FRESH AIR SUPPLY VENTILATION is enabled, the air conditioner continuously performs the ventilating operation with the OPERATION lamp off even after another operation is stopped. This happens when preparatory heating operation for QUICK HEATING TIMER is running. ▶ Page 21 This happens when the unit is in CLEANING FILTER operation. Wait for about 11 minutes. ▶ Page 28

Troubleshooting (for service personnel)

The room does not cool down/warm up

Case	Description / where to check
Air does not come out.	<input checked="" type="checkbox"/> <ul style="list-style-type: none"> ■ In HEATING operation <ul style="list-style-type: none"> • The air conditioner is warming up. Wait for about 1 to 4 minutes. ■ In COOLING / "SARARA" DRY / DRY COOLING operation <ul style="list-style-type: none"> • When the airflow rate setting is "AUTO", a function to prevent emission of an odour contained in the indoor unit operates. This keeps air from coming out immediately after operation is started. Wait for about 40 seconds. ▶ Page 14
Air does not come out / Air comes out.	<input type="checkbox"/> <ul style="list-style-type: none"> ■ Is the airflow rate setting appropriate? <ul style="list-style-type: none"> • Is the airflow rate setting low, such as "Indoor unit quiet" or "1"? Increase the airflow rate setting. ■ Is the set temperature appropriate? ■ Is the adjustment of the airflow direction appropriate?
Air comes out.	<input type="checkbox"/> <ul style="list-style-type: none"> • Is there any furniture directly under or beside the indoor unit? • Is the air conditioner in ECONO operation? ▶ Page 25 • Are the air filters dirty? • Is there anything blocking the air inlet or air outlet of the indoor unit or outdoor unit? • Is the window or door open? • Is the exhaust fan turning? • Are the ventilating operation and air conditioning operation used at the same time? <p style="text-align: right;">▶ Page 24</p>

Air has an odour

Case	Description / where to check
The air conditioner gives off an odour.	<input checked="" type="checkbox"/> <ul style="list-style-type: none"> • The air conditioner may take in an odour from outside. Stop humidifying operation and remove the cause of the odour. • When operation is switched to "SARARA" DRY operation, the humidity may increase temporarily, which may generate an odour. • The room odour absorbed in the unit is discharged with the airflow. We recommend you to have the indoor unit cleaned. Consult the service shop. • The air outlet may give out an odour because a small amount of ozone is generated. However, the amount is very small and does not harm your health. • This happens when the unit is in MOLD PROOF operation. ▶ Page 27

Commonly occurring sounds

Case	Description / where to check
Sound occurs during humidifying operation.	<input checked="" type="checkbox"/> <ul style="list-style-type: none"> ■ Operating sound is loud <ul style="list-style-type: none"> • In HUMID HEATING operation, the humidifying unit starts operating and therefore generates a slightly louder sound in the room. This sound is generated by the humidifying operation which becomes louder with increases in the airflow rate. • In ventilating operation, fresh air is taken in from outside. This may cause outside noise to sound loud. Operating sound becomes slightly louder as well. ▶ Page 24 ■ Operating sound changes <ul style="list-style-type: none"> • This happens when the humidifying fan starts or stops operating. • Outside sound may be loud.
Sound keeps coming out of the indoor unit even after humidifying operation is stopped.	<input checked="" type="checkbox"/> <ul style="list-style-type: none"> • To protect the air conditioner, the humidifying fan keeps turning for about another 3 minutes after operation is stopped.

Mist comes out

Case	Description / where to check
Mist comes out of the indoor unit.	<input checked="" type="checkbox"/> <ul style="list-style-type: none"> • This happens when the air in the room is cooled into mist by the cold airflow during COOLING or other operation. • This is because the air in the room is cooled by the heat exchanger and becomes mist during defrost operation.

Remote controller

Case	Description / where to check
The unit does not receive signals from the remote controller or has a low sensitivity. LCD is faint, is not working, or displays erratically.	<ul style="list-style-type: none"> ✓ The batteries may be exhausted. Replace all the batteries with new dry batteries AA.LR6 (alkaline). For details, refer to "Preparation before operation". ▶ Page 9
Other electric devices start operating.	<ul style="list-style-type: none"> ✓ If the remote controller activates other electric devices, move them away or consult the service shop.
2 air conditioners start operating at the same time.	<ul style="list-style-type: none"> ✓ If you do not want to operate 2 air conditioners at the same time, change the address setting. ▶ Page 34

Display

Case	Description / where to check
The air conditioner is operating even with the OPERATION lamp off.	<ul style="list-style-type: none"> ? Is the brightness of the indoor unit lamps set to "Off"? ▶ Page 10
The indoor unit lamps are dark.	<ul style="list-style-type: none"> ? Is the brightness of the indoor unit lamps set to "Low"? ▶ Page 10
When operation is started, the OPERATION lamp blinks for a while and then lights up.	<ul style="list-style-type: none"> ? Check the error code and consult the service shop. ▶ Page 40
The TIMER lamp blinks.	<ul style="list-style-type: none"> ? Clean the streamer unit. ▶ Page 36
The MOLD PROOF / CLEANING FILTER lamp blinks.	<ul style="list-style-type: none"> ? Clean the dust box. ▶ Page 37
The MOLD PROOF / CLEANING FILTER lamp blinks even after the dust box is cleaned.	<ul style="list-style-type: none"> ? Reset the dust box cleaning indicator. If the MOLD PROOF / CLEANING FILTER lamp still blinks, consult the service shop.

FLASH STREAMER AIR PURIFYING operation

Case	Description / where to check
There is a sign of burning on the metal section of the streamer unit.	<ul style="list-style-type: none"> ✓ This is a sign of streamer discharge and normal.
FLASH STREAMER AIR PURIFYING operation cannot be performed.	<ul style="list-style-type: none"> ? Is the front panel open? Close the front panel. ▶ Page 35 Is the streamer unit securely installed?
The sound of streamer discharge stopped.	<ul style="list-style-type: none"> ? Is the needle tip of the streamer unit dirty? Clean the needle. ▶ Page 36 Streamer discharge stops when the indoor temperature becomes close to the set temperature and the airflow rate decreases.

INTELLIGENT EYE sensor

Case	Description / where to check
The sensor does not respond.	<ul style="list-style-type: none"> ? The sensor is warming up for about 2 minutes after operation is started. Wait for a while. The sensor may not recognise small movements such as those made by sleeping persons or small children. The sensor may not work well if the indoor temperature is high. Even if the indoor temperature is low, the sensor may not recognise well persons whose clothing is cold just after coming back home in winter. The sensor does not work well especially when the person wears thick clothing. The sensor may not work well when a floor heating appliance or electric carpet is used. Make sure that the front panel is properly attached. If the front panel is not completely attached, the scope of the INTELLIGENT EYE sensor may become narrower. If the front panel is dirty, the sensor may not work. Clean the front panel. ▶ Page 35

Troubleshooting (for service personnel)

CLEANING FILTER operation

Case	Description / where to check
CLEANING FILTER operation does not function.	<input checked="" type="checkbox"/> <ul style="list-style-type: none"> To protect the air filters, CLEANING FILTER operation is not performed when the indoor temperature is 10°C or lower. ▶ Page 29 This happens when the MOLD PROOF / CLEANING FILTER lamp is blinking. Clean the dust box and reset the dust box cleaning indicator. ▶ Page 37
CLEANING FILTER operation is long.	<input checked="" type="checkbox"/> <ul style="list-style-type: none"> This is to protect the air conditioner. After humidifying or ventilating operation is stopped, CLEANING FILTER operation is not performed until the humidifying fan stops. Wait for about 15 minutes.
CLEANING FILTER operation does not stop. [MOLD PROOF / CLEANING FILTER lamp is off]	<input checked="" type="checkbox"/> <ul style="list-style-type: none"> ■ After the operation has been stopped manually <ul style="list-style-type: none"> The air filter is moving back to the normal position. Wait for up to about 3 minutes.
The air filter gets stuck during CLEANING FILTER operation.	<input type="checkbox"/> <ul style="list-style-type: none"> Check to see whether the filter section of the air filter is not deformed. Check to see whether the air filter, air-purifying and deodorising filter, and dust box are properly attached. ▶ Page 37-39
A large noise occurs in CLEANING FILTER operation.	<p>If the filter section of the air filter is deformed, consult the service shop.</p>
The air filter is still dirty even after CLEANING FILTER operation is performed.	<input type="checkbox"/> <ul style="list-style-type: none"> Is there too much dust in the dust box? ▶ Page 37 Grease and tar from tobacco may not be removed completely. Clean the air filter. ▶ Page 38

Others

Case	Description / where to check
Cold air comes out of the air conditioner when "SARARA" DRY operation is started.	<input checked="" type="checkbox"/> <ul style="list-style-type: none"> This is to quickly reduce the humidity.
Warm air comes out of the air conditioner during "URURU" HUMIDIFY operation.	<input checked="" type="checkbox"/> <ul style="list-style-type: none"> The air conditioner may perform weak HEATING operation when the indoor temperature becomes low.
The flaps do not close when operation is stopped.	<input type="checkbox"/> <ul style="list-style-type: none"> Did anyone touch the flaps while the air conditioner is in operation? Restart operation and stop it again to properly close the flaps.
The air conditioner suddenly starts showing strange behaviour during operation.	<input type="checkbox"/> <ul style="list-style-type: none"> The air conditioner may malfunction due to lightning or radio. If the air conditioner malfunctions, turn off the power with the circuit breaker and restart the operation with the remote controller.

Notes on operating conditions

- The air conditioner always consumes a small amount of electricity even while it is not operating.
- If the operation is continued under any conditions other than the table below,
 - A safety device may activate to stop the operation.
 - Dew may form on the indoor unit and drip from it when COOLING or "SARARA" DRY operation is selected.

	COOLING	"SARARA" DRY	HEATING	"URURU" HUMIDIFY
Outdoor temperature	-10-43°C	18-42°C	-20-24°C	-10-24°C
Indoor temperature	18-32°C	18-30°C	10-30°C	12-30°C
Indoor humidity	80% max.	80% max.	70% max.	70% max.

Call the service shop immediately

WARNING

- **When an abnormality (such as a burning smell) occurs, stop operation and turn the circuit breaker off.**
 - Continued operation in an abnormal condition may result in troubles, electric shocks or fire.
 - Consult the service shop where you bought the air conditioner.
- **Do not attempt to repair or modify the air conditioner by yourself.**
 - Incorrect work may result in electric shocks or fire.
 - Consult the service shop where you bought the air conditioner.

If one of the following symptoms takes place, call the service shop immediately.

- The power cord is abnormally hot or damaged.
- An abnormal sound is heard during operation.
- The circuit breaker, a fuse, or the earth leakage circuit breaker cuts off the operation frequently.
- A switch or a button often fails to work properly.
- There is a burning smell.
- Water leaks from the indoor unit.

Turn off the circuit breaker and call the service shop.



■ After a power failure

- The air conditioner automatically resumes operation in about 3 minutes. You should just wait for a while.
- When AUTO RESTART is "Off", start the operation using the remote controller.

■ Lightning

- If lightning may strike the neighbouring area, stop operation and turn the circuit breaker off for system protection.

■ When not in use for extended periods

- 1) Perform MOLD PROOF operation on a sunny day to dry the inside well. (How to perform MOLD PROOF operation. [▶ Page 27](#))
- 2) After operation is stopped, turn off the circuit breaker for the air conditioner.
- 3) Remove the batteries from the remote controller.
 - To resume using the air conditioner, turn on the circuit breaker. The air conditioner performs the operating check of each part.

Disposal requirements



Your product and the batteries supplied with the controller are marked with this symbol. This symbol means that electrical and electronic products and batteries shall not be mixed with unsorted household waste. For batteries, a chemical symbol can be printed beneath the symbol. This chemical symbol means that the battery contains a heavy metal above a certain concentration. Possible chemical symbols are:

■ Pb: lead (>0.004%)

Do not try to dismantle the system yourself: the dismantling of the product, treatment of the refrigerant, of oil and of other parts must be done by a qualified installer in accordance with relevant local and national legislation. Units and waste batteries must be treated at a specialized treatment facility for re-use, recycling and recovery. By ensuring correct disposal, you will help to prevent potential negative consequences for the environment and human health. Please contact the installer or local authority for more information.

Important information regarding the refrigerant used

- This product contains fluorinated greenhouse gases covered by the Kyoto Protocol.
Refrigerant type: **R32**
GWP⁽¹⁾ value: **550** *
⁽¹⁾GWP = global warming potential
- Periodical inspections for refrigerant leaks may be required depending on European or local legislation. Please contact your local dealer for more information.
* This value is based on F gas regulation (824/2006).

Part 6

Service Diagnosis

1. Service Diagnosis	124
1.1 Indoor Unit.....	124
1.2 Outdoor Unit.....	124
1.3 Remote Controller	124
2. Troubleshooting	126
2.1 Error Codes and Description	126
2.2 Air conditioner does not run.	127
2.3 Air conditioner runs but does not cool (heat) the room.	129
2.4 When operation starts, safety breaker works.	130
2.5 Air conditioner makes big noise and vibration.....	131
2.6 Air is not humidified enough.	132
2.7 FLASH STREAMER AIR PURIFYING operation does not run.	133
2.8 INTELLIGENT EYE operation does not run.	134
2.9 Indoor Unit PCB Abnormality	135
2.10 Freeze-up Protection Control / Heating Peak-cut Control	136
2.11 Fan Motor (DC Motor) or Related Abnormality.....	138
2.12 Thermistor or Related Abnormality (Indoor Unit).....	140
2.13 Humidity Sensor (for Humidifying) / Humidifying Thermistor Abnormality	141
2.14 Humidity Sensor (for Room) Abnormality.....	142
2.15 Outdoor Unit PCB Abnormality.....	143
2.16 OL Activation (Compressor Overload)	144
2.17 Compressor Lock	146
2.18 DC Fan Lock	147
2.19 Input Overcurrent Detection	148
2.20 Four Way Valve Abnormality.....	149
2.21 Discharge Pipe Temperature Control.....	151
2.22 High Pressure Control in Cooling	152
2.23 Compressor System Sensor Abnormality	153
2.24 Power Factor Correction Circuit Abnormality	154
2.25 Damper Abnormality.....	155
2.26 Position Sensor Abnormality	156
2.27 Thermistor or Related Abnormality (Outdoor Unit).....	158
2.28 Electrical Box Temperature Rise	160
2.29 Radiation Fin Temperature Rise	161
2.30 Output Overcurrent Detection	163
2.31 Humidifier Fan Motor System Abnormality / Fan Lock	165
2.32 Heater Wire Abnormality	166
2.33 Humidifying Thermistor Abnormality / Humidifying Heater Temperature Abnormality	167
2.34 Refrigerant Shortage	169
2.35 Low-voltage Detection or Over-voltage Detection.....	171
2.36 Signal Transmission Error (Between Indoor Unit and Outdoor Unit)....	173
2.37 Outdoor Unit PCB Abnormality or Communication Circuit Abnormality	175

2.38	Signal Transmission Error on Microcomputer for Humidifying	178
2.39	Unspecified Voltage (Between Indoor Unit and Outdoor Unit)	179
2.40	Improper Power Supply Wiring.....	180
2.41	Incomplete Setting for Hose Length	181
2.42	Lights-out of Microcomputer Status Lamp.....	182
3.	Check.....	183
3.1	Thermistor Resistance Check	183
3.2	Fan Motor Connector Output Check	184
3.3	Humidity Sensor Check.....	184
3.4	Power Supply Waveforms Check.....	185
3.5	Electronic Expansion Valve Check.....	185
3.6	Four Way Valve Performance Check	186
3.7	Inverter Unit Refrigerant System Check.....	186
3.8	Inverter Analyser Check	187
3.9	Rotating Pulse Check on Outdoor Unit PCB	189
3.10	Installation Condition Check.....	190
3.11	Discharge Pressure Check.....	190
3.12	Outdoor Fan System Check	191
3.13	Main Circuit Short Check.....	191
3.14	Power Module Check	192

1. Service Diagnosis

1.1 Indoor Unit

The operation lamp blinks when any of the following errors is detected.

1. When a protection device of the indoor or outdoor unit is activated, or when the thermistor malfunctions.
 2. When a signal transmission error occurs between the indoor and outdoor units.
- In either case, conduct the diagnostic procedure described in the following pages.

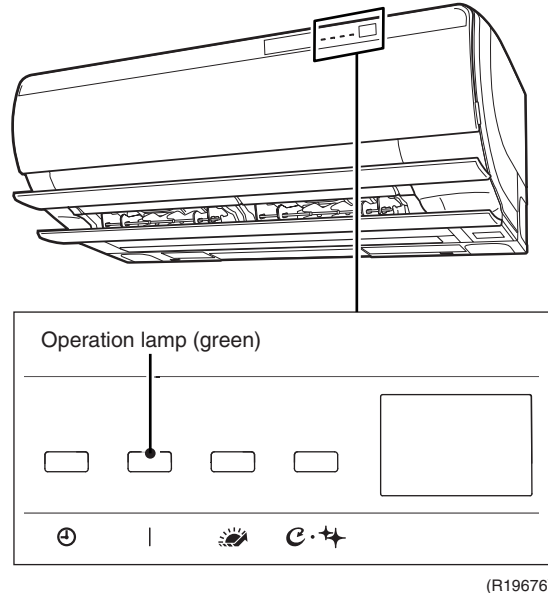

(R19676)

1.2 Outdoor Unit

The outdoor unit has one green LED (LED A) on the PCB. When the microcomputer works in order, the LED A blinks.

1.3 Remote Controller

Confirm the error code with the remote controller.

Method 1

- (1) Open the cover of the remote controller.
- (2) Press the **CANCEL** button for 5 seconds pointing the remote controller at the indoor unit.
- (3) The display on the remote controller shows an error code with a beep.

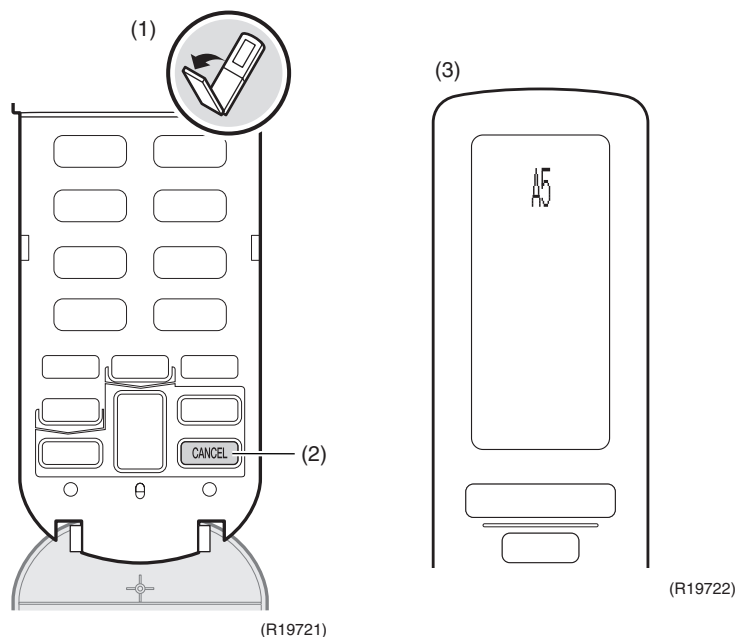

(R19721)

(R19722)

Method 2

- (1) Open the cover of the remote controller.
- (2) Press the **SET UP** button for 5 seconds.
- (3) Press the **▲** or **▼** button and select **Checking error code**.
- (4) Press the **APPLY** button pointing the remote controller at the indoor unit.
- (5) The display on the remote controller shows an error code with a long beep.



Note: To return to the normal mode, press the **SET UP** button for 5 seconds again or leave the remote controller untouched for 60 seconds.

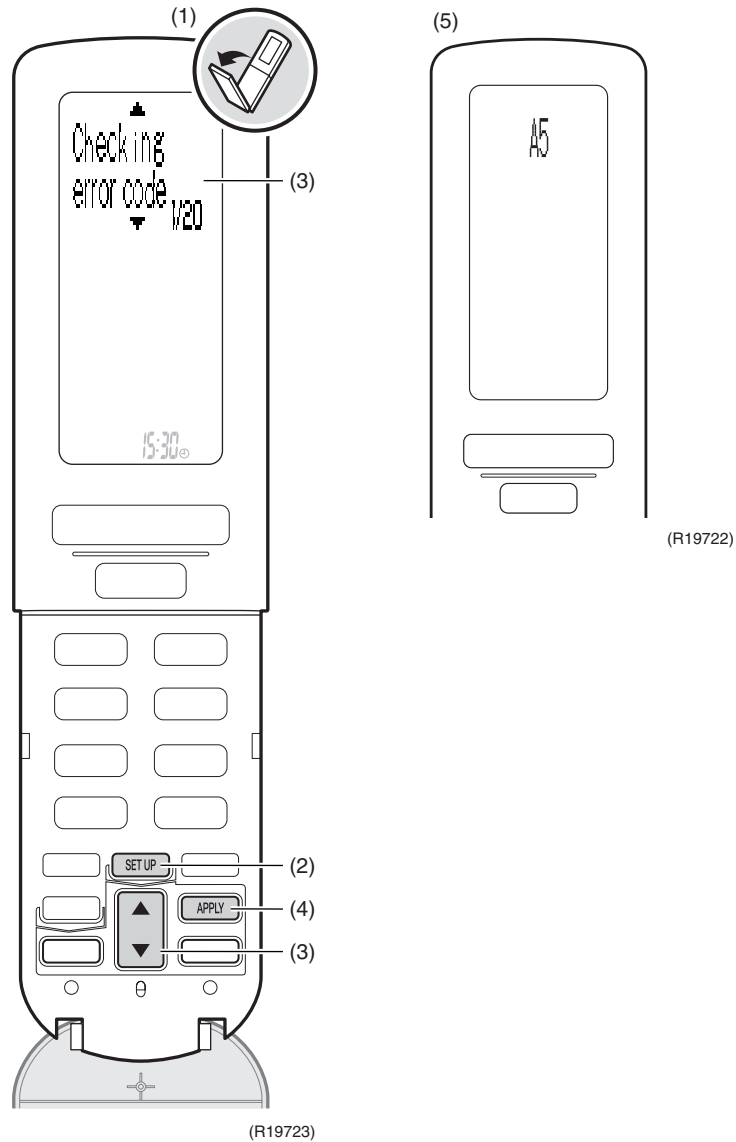

2. Troubleshooting

2.1 Error Codes and Description

Error Code	Unit	Description	Reference page	
Basic Failure Diagnosis		Air conditioner does not run.	127	
		Air conditioner runs but does not cool (heat) the room.	129	
		When operation starts, safety breaker works.	130	
		Air conditioner makes big noise and vibration.	131	
		Air is not humidified enough.	132	
		FLASH STREAMER AIR PURIFYING operation does not run.	133	
		INTELLIGENT EYE operation does not run.	134	
A1	Indoor	Indoor unit PCB abnormality	135	
A5		Freeze-up protection control / heating peak-cut control	136	
A6		Fan motor (DC motor) or related abnormality	138	
C4		Indoor heat exchanger thermistor or related abnormality	140	
C9		Room temperature thermistor or related abnormality	140	
CA		Humidity sensor (for humidifying) / humidifying thermistor abnormality	141	
CC		Humidity sensor (for room) abnormality	142	
E1	Outdoor	Outdoor unit PCB abnormality	143	
E5		OL activation (compressor overload)	144	
E6		Compressor lock	146	
E7		DC fan lock	147	
E8		Input overcurrent detection	148	
EA		Four way valve abnormality	149	
F3		Discharge pipe temperature control	151	
F6		High pressure control in cooling	152	
H0		Compressor system sensor abnormality	153	
		Power factor correction circuit abnormality	154	
H1		Damper abnormality	155	
H6		Position sensor abnormality	156	
H9		Outdoor temperature thermistor or related abnormality	158	
J3		Discharge pipe thermistor or related abnormality	158	
J6		Outdoor heat exchanger thermistor or related abnormality	158	
J8		Liquid pipe thermistor or related abnormality	158	
L3		Electrical box temperature rise	160	
L4		Radiation fin temperature rise	161	
L5		Output overcurrent detection	163	
P4		Radiation fin thermistor or related abnormality	158	
P9		Humidifying unit	Humidifier fan motor system abnormality / fan lock	165
PA			Heater wire abnormality	166
PH			Humidifying thermistor abnormality / humidifying heater temperature abnormality	167
U0	System	Refrigerant shortage	169	
U2		Low-voltage detection or over-voltage detection	171	
U4		Signal transmission error (between indoor unit and outdoor unit)	173	
	Outdoor	Outdoor unit PCB abnormality or communication circuit abnormality	175	
U7	Humidifying unit	Signal transmission error on microcomputer for humidifying	178	
UA	System	Unspecified voltage (between indoor unit and outdoor unit)	179	
		Improper power supply wiring	180	
	Indoor	Incomplete setting for hose length	181	
	System	Lights-out of microcomputer status lamp	182	

2.2 Air conditioner does not run.

Supposed Causes

- Power supply is OFF.
- Improper power supply voltage
- Improper connection of wire
- Incorrect combination of indoor unit and outdoor unit
- Battery shortage of remote controller
- Invalid address setting
- Protection device works
(dirty air filter, refrigerant shortage, overfilling, mixed air, etc.)
- Transmission error between indoor unit and outdoor unit
(Defective outdoor unit PCB)

Troubleshooting



Caution Be sure to turn off the power switch before connecting or disconnecting connectors, or parts may be damaged.

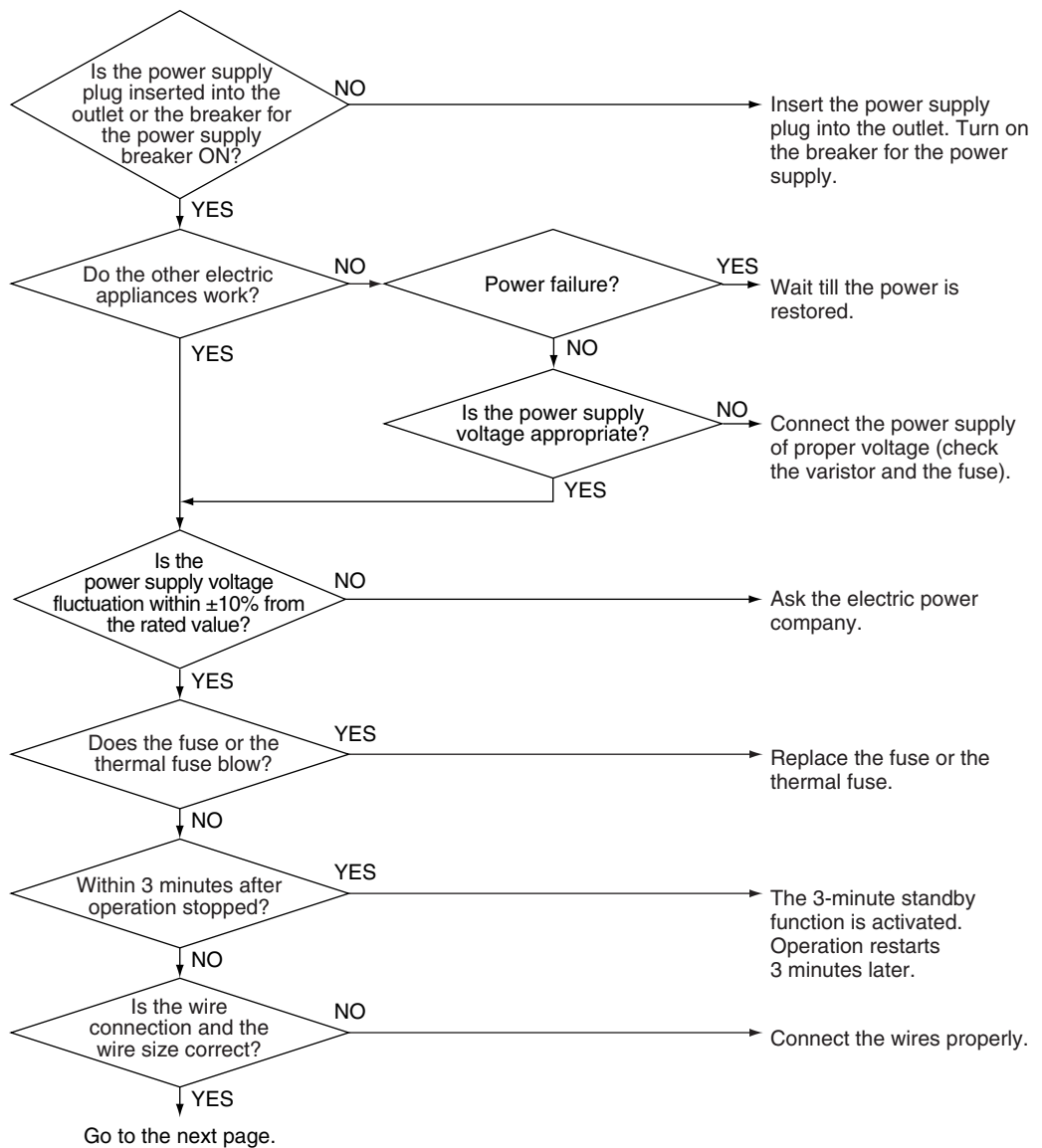

(R19677)

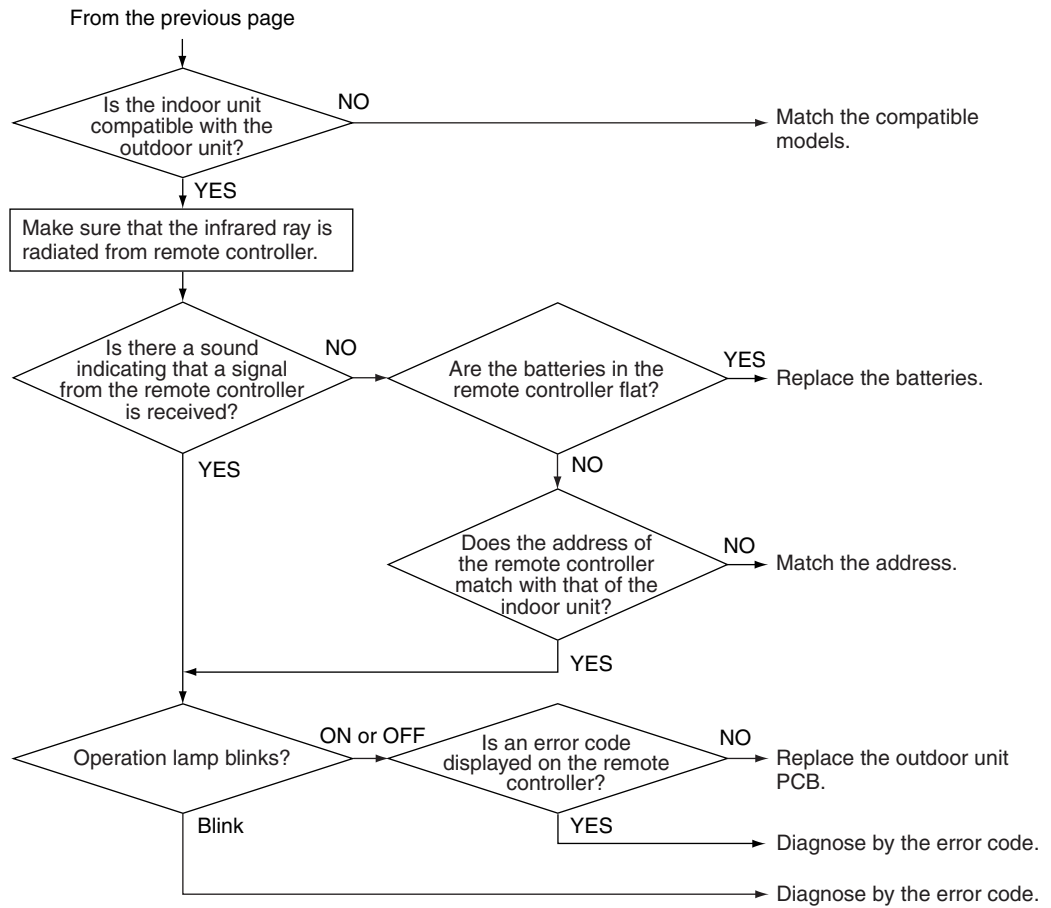

(R19678)

2.3 Air conditioner runs but does not cool (heat) the room.

Supposed Causes

- Refrigerant leakage
(Make sure that there is no refrigerant leakage or breaks due to over-tightened flare part.)
- Improper setting for temperature
- Incorrect combination of indoor unit and outdoor unit
- Clogged air filter
- Insufficient power
- Refrigerant piping is too long
- Defective field piping (squeezed, etc.)

Troubleshooting



Check No.01
Refer to P.183



Caution

Be sure to turn off the power switch before connecting or disconnecting connectors, or parts may be damaged.

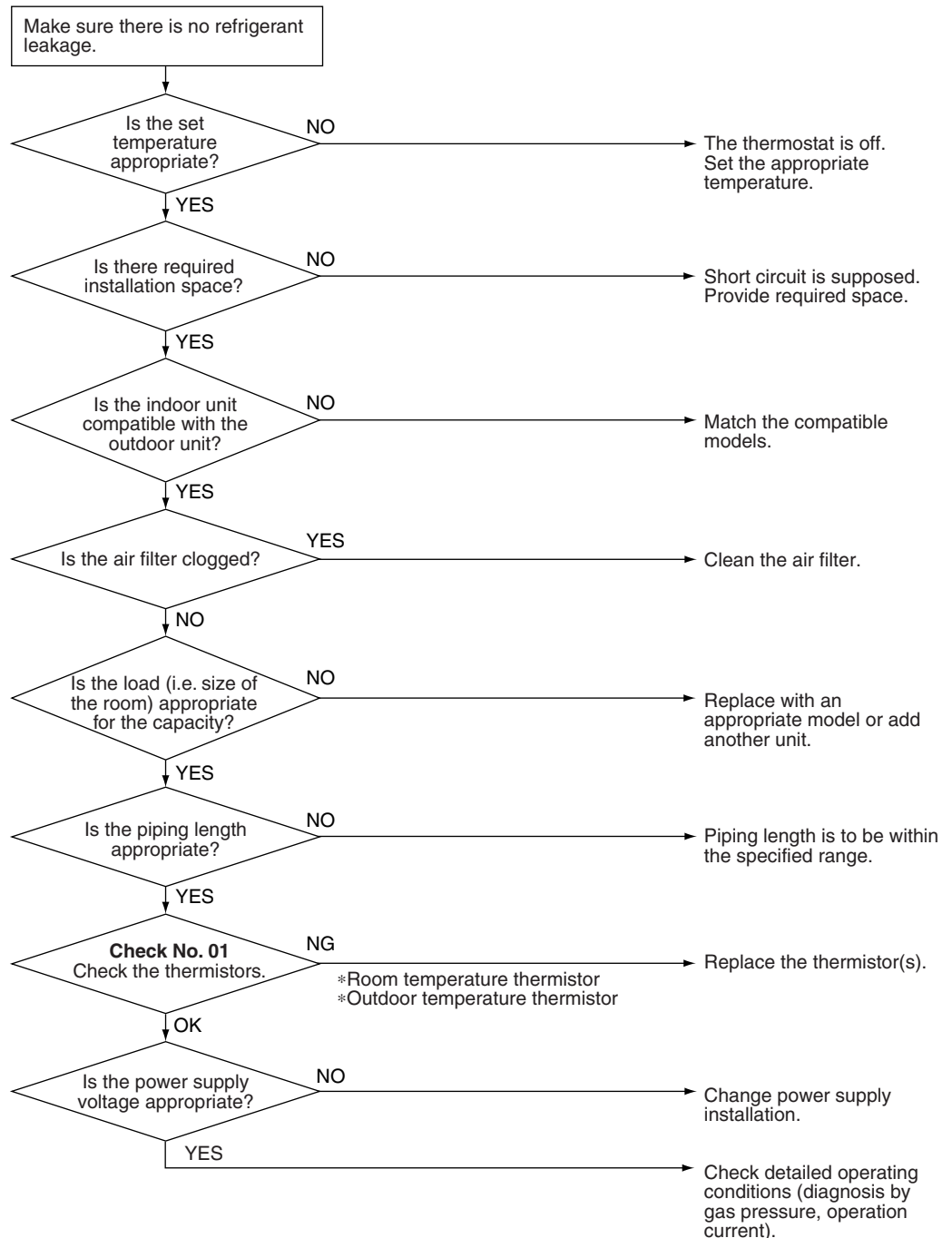

(R19679)

2.4 When operation starts, safety breaker works.

Supposed Causes

- Insufficient capacity of safety breaker
- Earth leakage breaker is too sensitive.
- Not exclusive circuit
- The power supply voltage fluctuation is not within $\pm 10\%$ from the rated value.
- The size of connecting wire is thin.
- Air is mixed.
- Overfilling of refrigerant
- Defective outdoor unit PCB (short circuit)

Troubleshooting



Check No.20
Refer to P.191

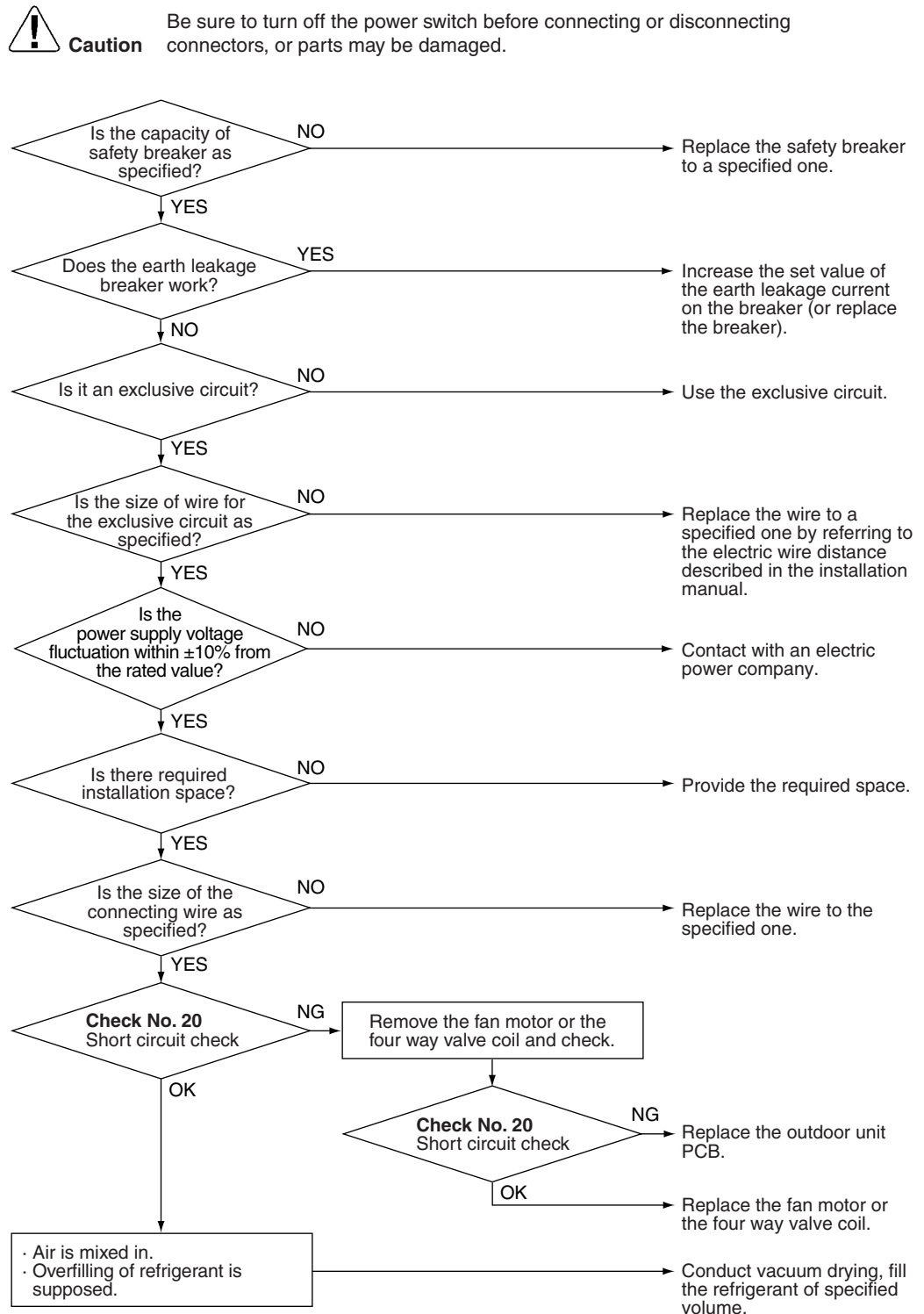

(R19680)

2.5 Air conditioner makes big noise and vibration.

Supposed Causes

- Refrigerant piping is too short.
- Mounting wall is too thin.
- Insufficient vibration prevention measures
- Deformation of the unit
- Improper quantity of refrigerant

Troubleshooting



Caution

Be sure to turn off the power switch before connecting or disconnecting connectors, or parts may be damaged.

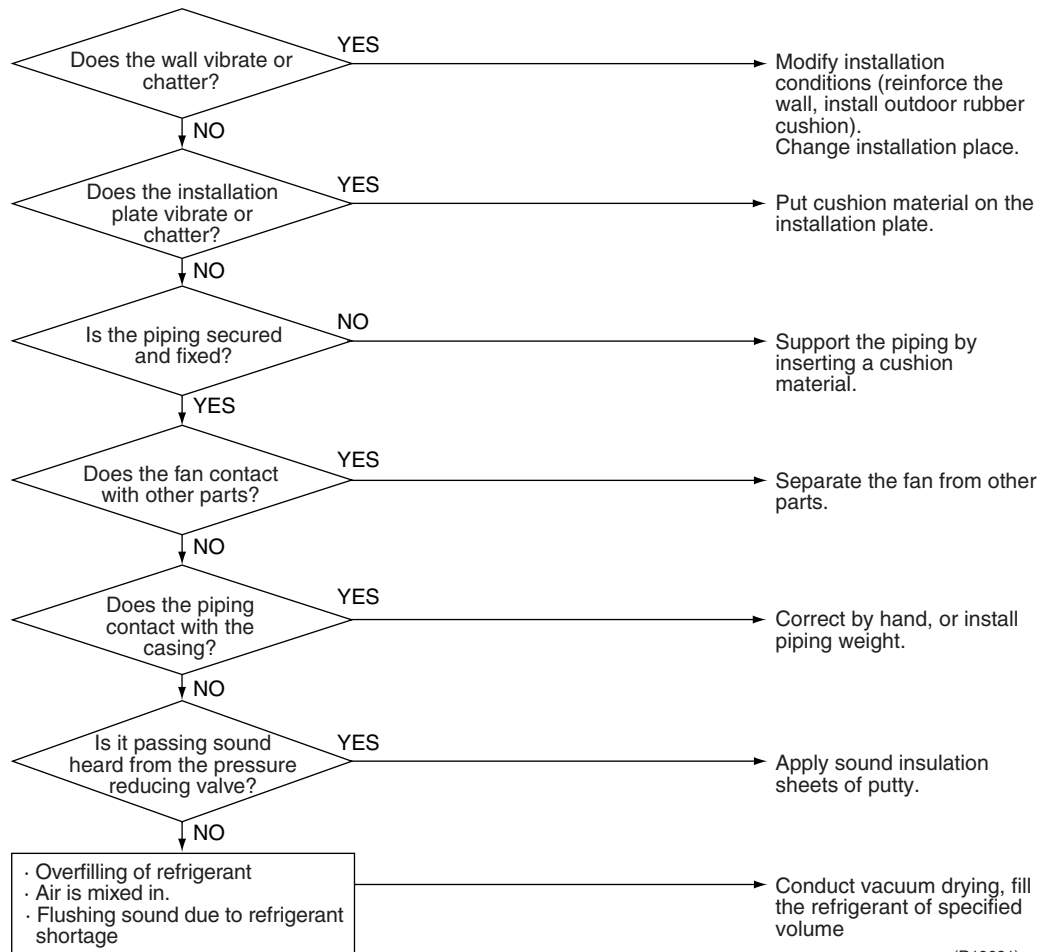

(R19681)

2.6 Air is not humidified enough.

Supposed Causes

- Hose length is not set.
- Improper setting for hose length
- Air is short-circuited at outdoor unit.
- Clogged air supply filter
- Insufficient heat insulation of duct
- Indoor ventilation is made too often.
- Ceiling is very high.

Troubleshooting

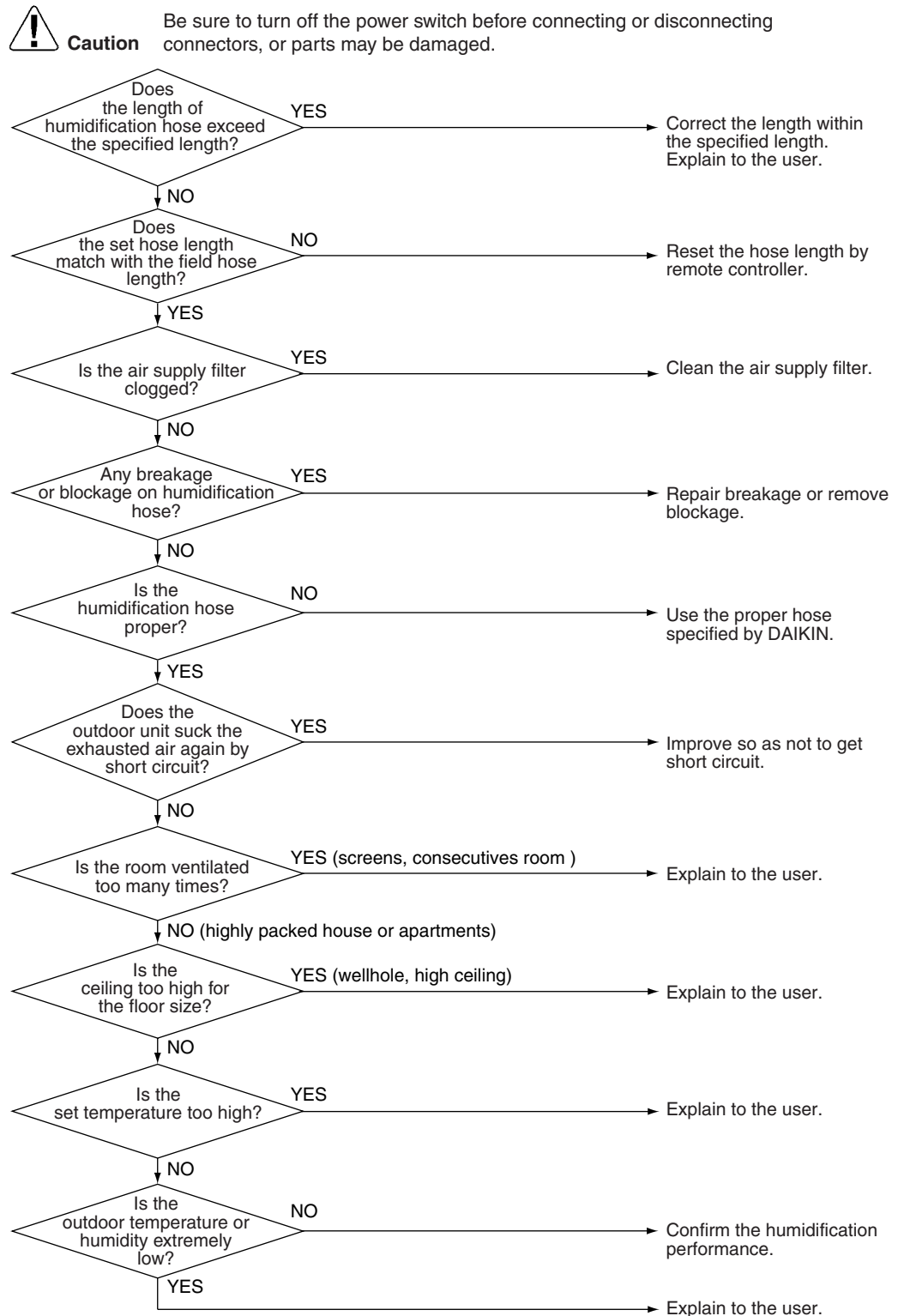

(R19682)

2.7 FLASH STREAMER AIR PURIFYING operation does not run.

Supposed Causes

- Front panel is open.
- Streamer unit cleaning indicator is not reset.
- Streamer unit is not installed.
- Dirty streamer unit
- Dust adheres to the needles of the streamer unit.
- Broken needles of streamer unit
- Disconnection of the connector
- Defective limit switch of the streamer unit

Troubleshooting



Check No.01
Refer to P.183



Caution Be sure to turn off the power switch before connecting or disconnecting connectors, or parts may be damaged.

* Streamer unit starts electric discharge 90 ~ 180 seconds after air purifying operation.

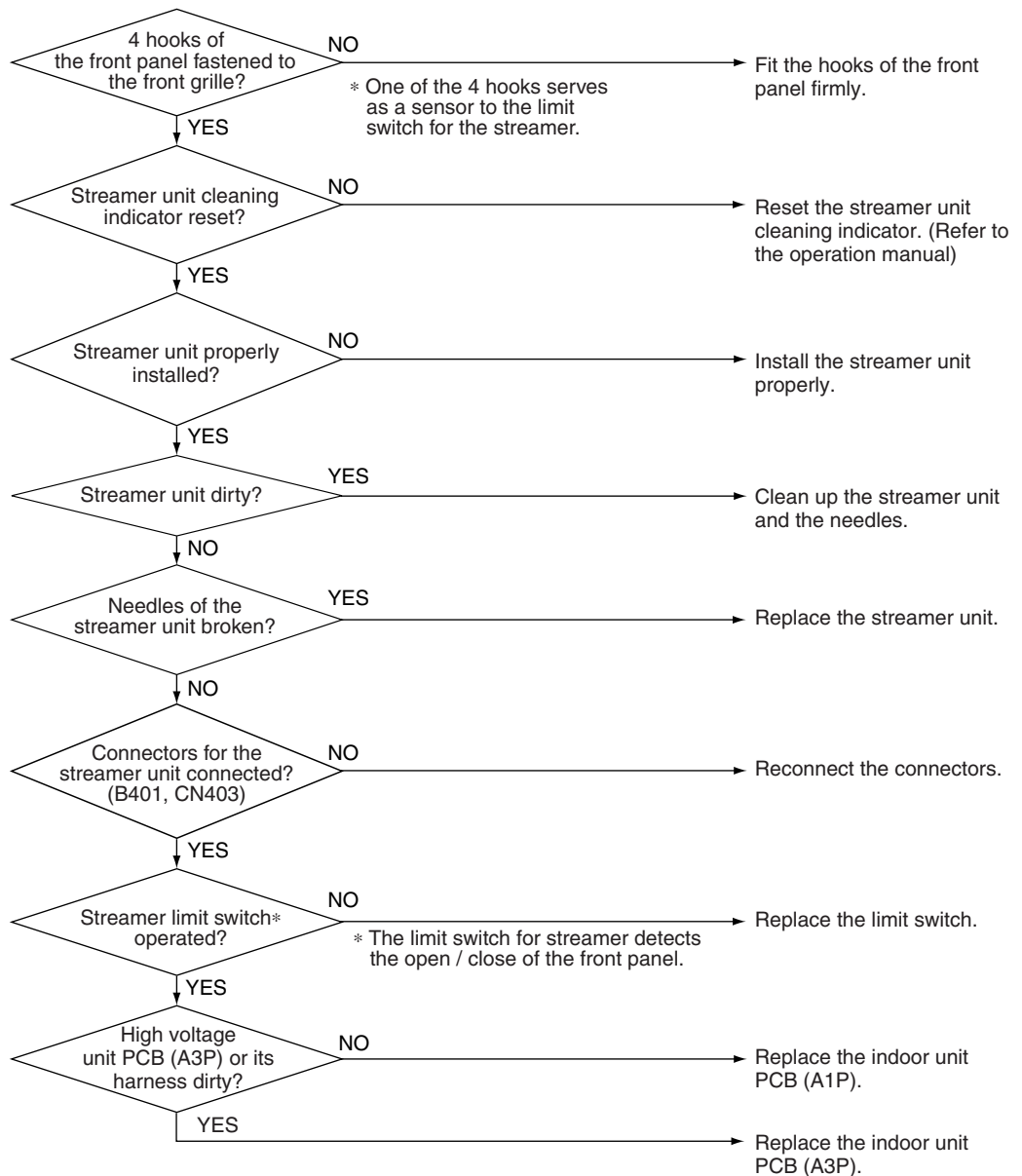

(R20442)

2.8 INTELLIGENT EYE operation does not run.

Supposed Causes

- Defective INTELLIGENT EYE sensor unit
- Disconnection of the harness
- Dirt on the front panel
- Dirt on the lens of the INTELLIGENT EYE sensor unit

Troubleshooting



Caution

Be sure to turn off the power switch before connecting or disconnecting connectors, or parts may be damaged.

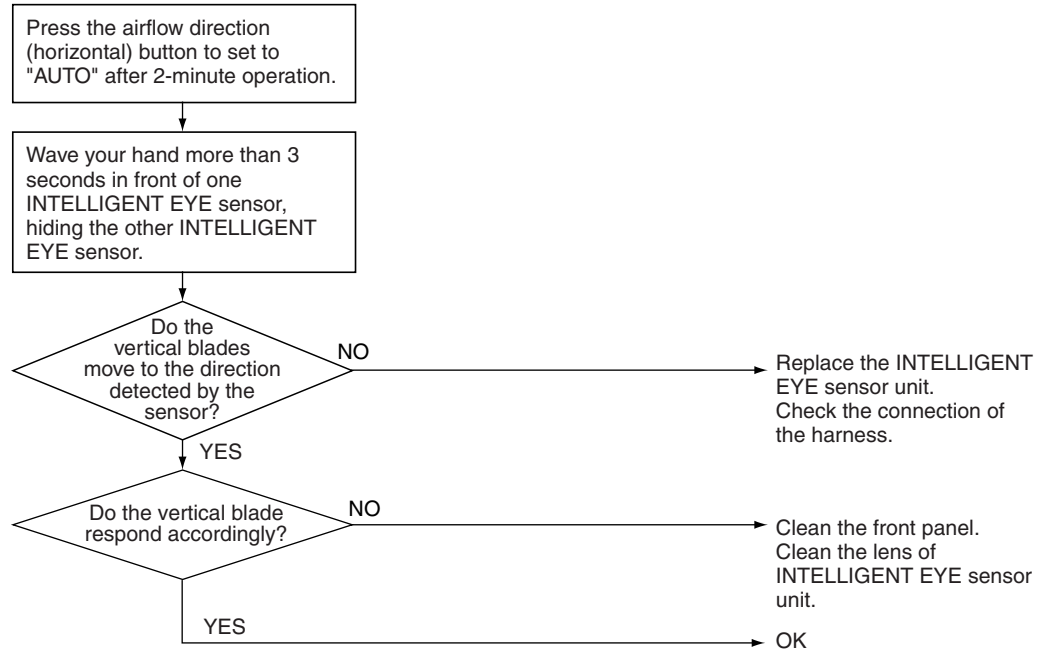

(R20443)

- Check the other sensor in the same way.



Note:

The INTELLIGENT EYE sensors recognize where human motion occurs.

- The sensors work within 9 m distance in front of the indoor unit.
- The sensors do not work directly below or directly beside the indoor unit.
- The sensors might misdetect other heaters, or home electric appliances, the motion of small animals like dogs and cats as a human motion.
- The sensors might also detect a place of sunlight wrongly.
- In case the sensors detect several people in a room, the airflow is directed to the last detected person.

2.9 Indoor Unit PCB Abnormality

Error Code	A1
Method of Error Detection	The system checks if the circuit works properly within the microcomputer of the indoor unit.
Error Decision Conditions	The system cannot set the internal settings.
Supposed Causes	<ul style="list-style-type: none"> ■ Wrong models interconnected ■ Defective indoor unit PCB (A1P) ■ Disconnection of connector ■ Reduction of power supply voltage

Troubleshooting

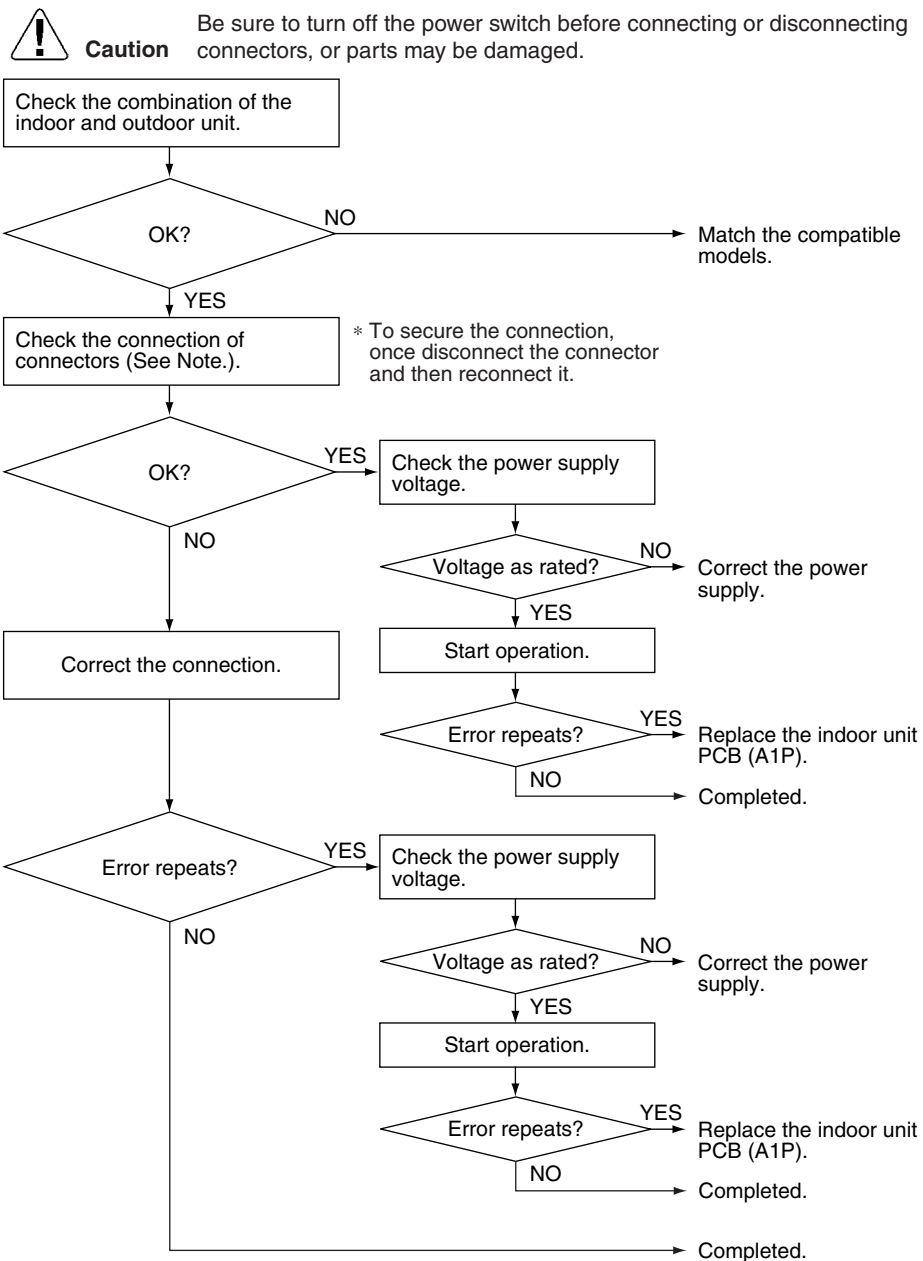

Note: Check the following connector.

Model Type	Connector
Wall mounted type	Terminal board ~ Control PCB (H1, H2, H3)

(R19513)

2.10 Freeze-up Protection Control / Heating Peak-cut Control

Error Code	A5
Method of Error Detection	<ul style="list-style-type: none"> ■ Freeze-up protection control During cooling operation, the freeze-up protection control (operation halt) is activated according to the temperature detected by the indoor heat exchanger thermistor. ■ Heating peak-cut control During heating operation, the temperature detected by the indoor heat exchanger thermistor is used for the heating peak-cut control (operation halt, outdoor fan stop, etc.)
Error Decision Conditions	<ul style="list-style-type: none"> ■ Freeze-up protection control During cooling operation, the indoor heat exchanger temperature is below 0°C. ■ Heating peak-cut control During heating operation, the indoor heat exchanger temperature is above 54.5°C
Supposed Causes	<ul style="list-style-type: none"> ■ Short-circuited air ■ Clogged air filter of the indoor unit ■ Dust accumulation on the indoor heat exchanger ■ Defective indoor heat exchanger thermistor ■ Defective indoor unit PCB (A1P)

Troubleshooting



Check No.01
Refer to P.183



Caution

Be sure to turn off the power switch before connecting or disconnecting connectors, or parts may be damaged.

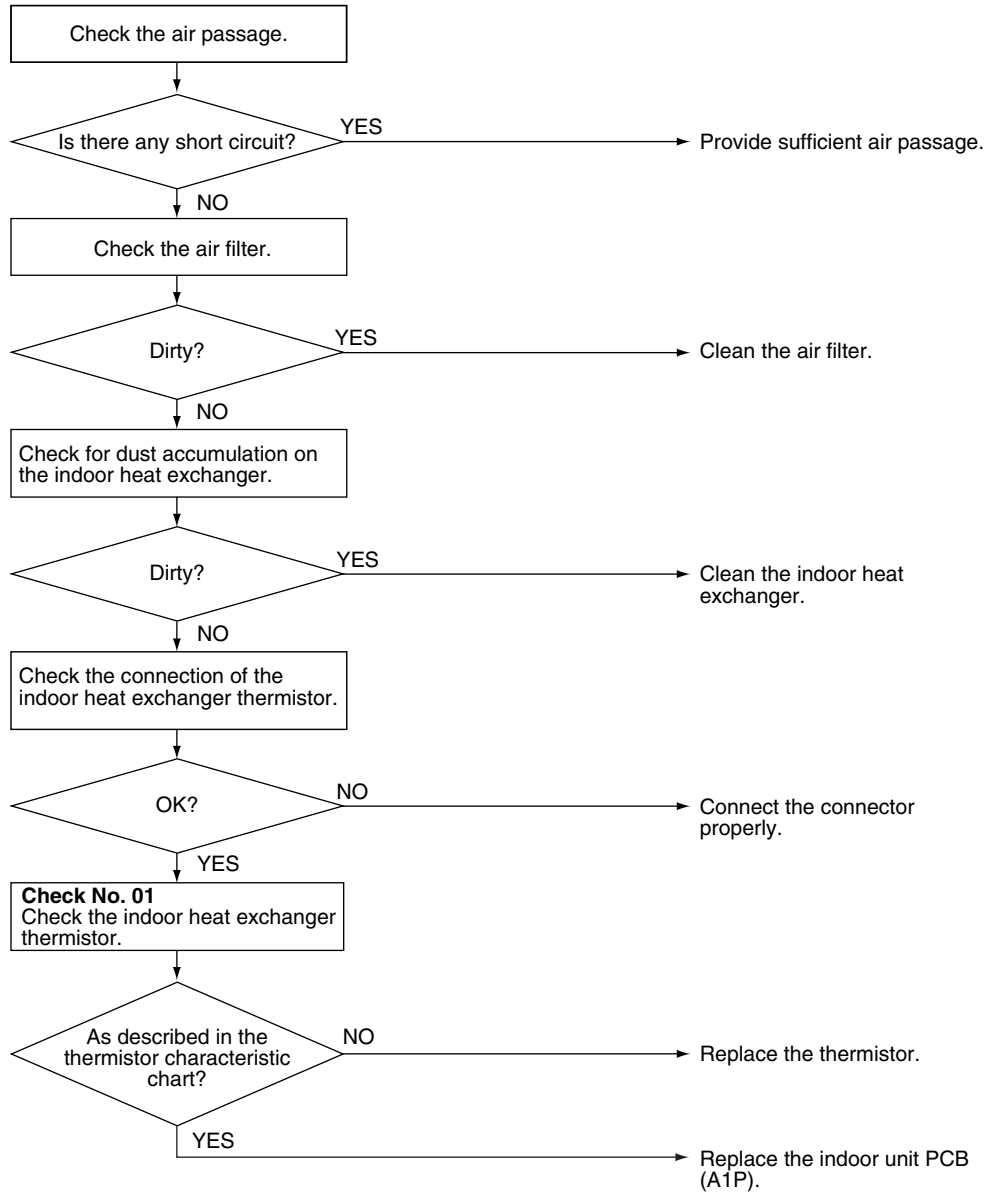

(R19514)

2.11 Fan Motor (DC Motor) or Related Abnormality

Error Code

A6

Method of Error Detection

The rotation speed detected by the microcomputer during fan motor operation is used to determine abnormal fan motor operation.

Error Decision Conditions

- The detected rotation speed is less than 50% of HH tap when the maximum fan motor rotation speed is commanded.
 - The fan does not rotate for more than 5 seconds after operation starts.
-

Supposed Causes

- Remarkable decrease in power supply voltage
- Layer short inside the fan motor winding
- Breaking of wire inside the fan motor
- Breaking of the fan motor lead wires
- Defective indoor unit PCB (A1P)

Troubleshooting

Check No.02
Refer to P.184

 **Caution** Be sure to turn off the power switch before connecting or disconnecting connectors, or parts may be damaged.

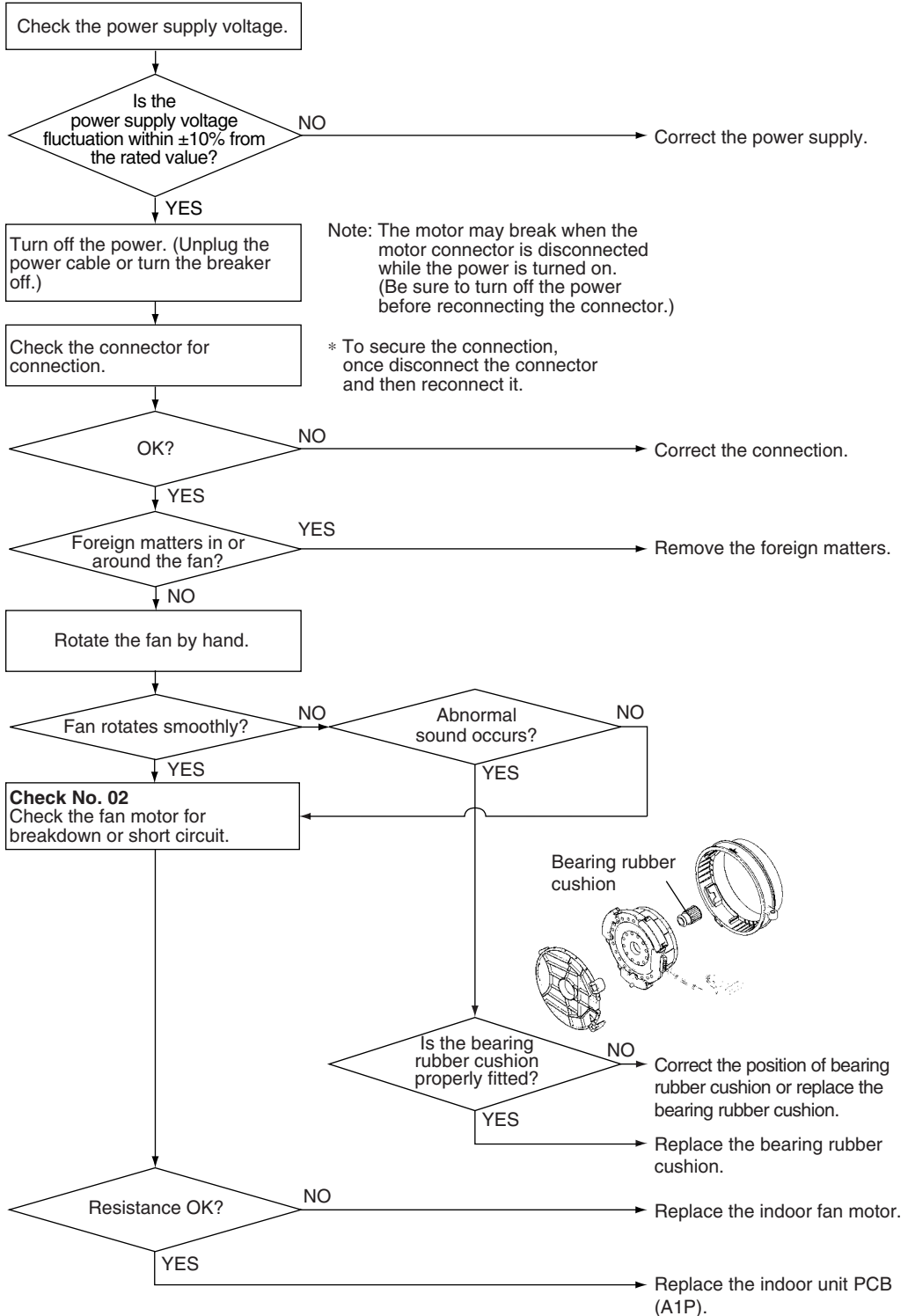

(R19724)

2.12 Thermistor or Related Abnormality (Indoor Unit)

Error Code	C4, C9
Method of Error Detection	The temperatures detected by the thermistors determine thermistor errors.
Error Decision Conditions	The thermistor input is 4.96 V and more or 0.04 V and less during compressor operation.
Supposed Causes	<ul style="list-style-type: none"> ■ Disconnection of connector ■ Thermistor corresponding to the error code is defective. ■ Defective indoor unit PCB (A1P, A4P)

Troubleshooting

Check No.01
 Refer to P.183

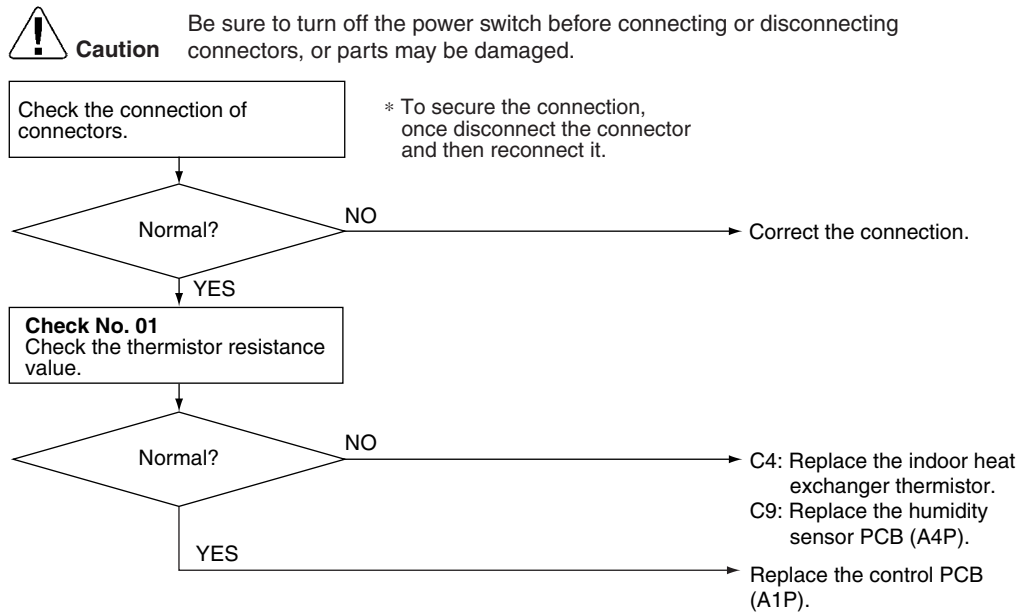

(R19725)

C4 : Indoor heat exchanger thermistor
C9 : Room temperature thermistor

2.13 Humidity Sensor (for Humidifying) / Humidifying Thermistor Abnormality

Error Code	CA
Method of Error Detection	The humidity detected by the humidity sensor determine humidity sensor errors.
Error Decision Conditions	The input from the humidity sensor is 4.96 V and more or 0.04 V and less during compressor operation.
Supposed Causes	<ul style="list-style-type: none"> ■ Disconnection of connector ■ Defective humidity sensor ■ Defective indoor unit PCB (A1P, A5P)

Troubleshooting

 **Check No.01**
Refer to P.183

 **Check No.07**
Refer to P.184

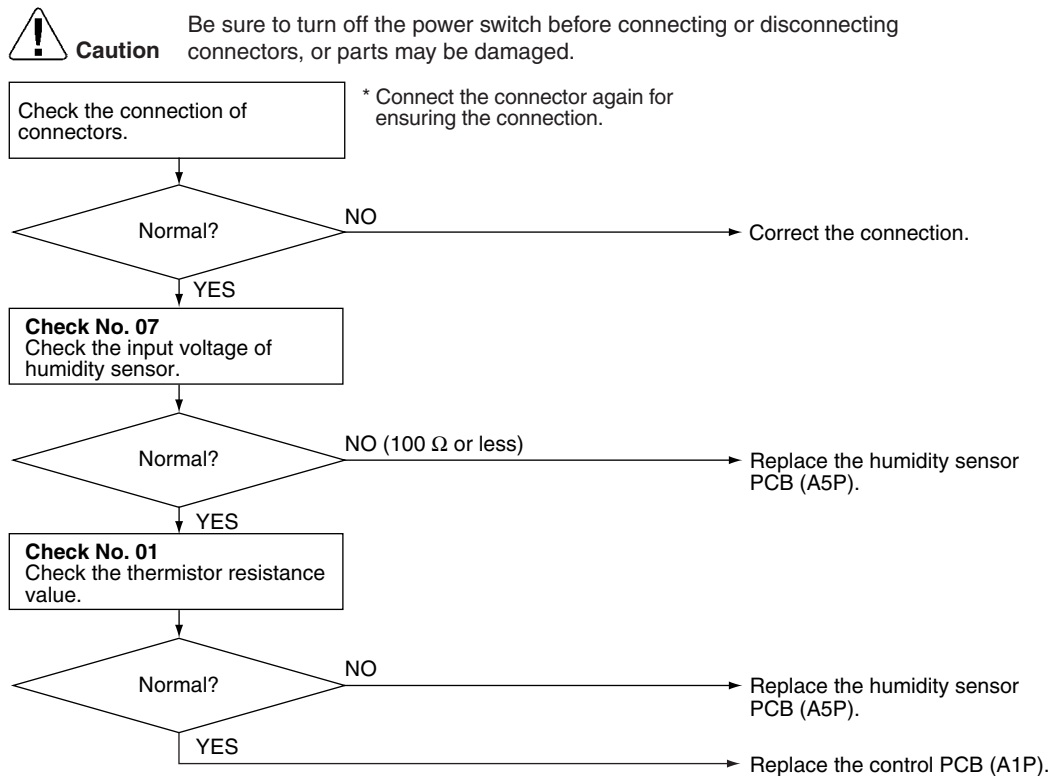

(R19726)

2.14 Humidity Sensor (for Room) Abnormality

Error Code	CC
Method of Error Detection	Sensor abnormality is detected by input value.
Error Decision Conditions	The input from the humidity sensor is 4.96 V and more or 0.04 V and less.
Supposed Causes	<ul style="list-style-type: none"> ■ Disconnection of connector ■ Defective humidity sensor ■ Defective indoor unit PCB (A1P, A4P)

Troubleshooting



Check No.07 Refer to P.184



Caution

Be sure to turn off the power switch before connecting or disconnecting connectors, or parts may be damaged.

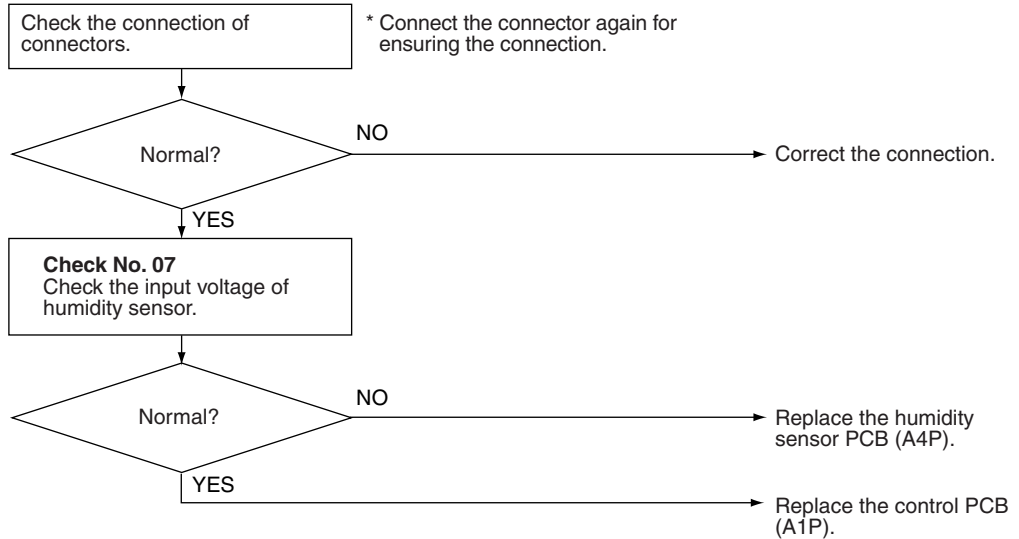

(R19683)

2.15 Outdoor Unit PCB Abnormality

Error Code	E1
Method of Error Detection	Detect within the programme of the microcomputer.
Error Decision Conditions	The programme of the microcomputer is in abnormal running order.
Supposed Causes	<ul style="list-style-type: none"> ■ Defective outdoor unit PCB ■ Noise ■ Momentary drop of voltage ■ Momentary power failure

Troubleshooting

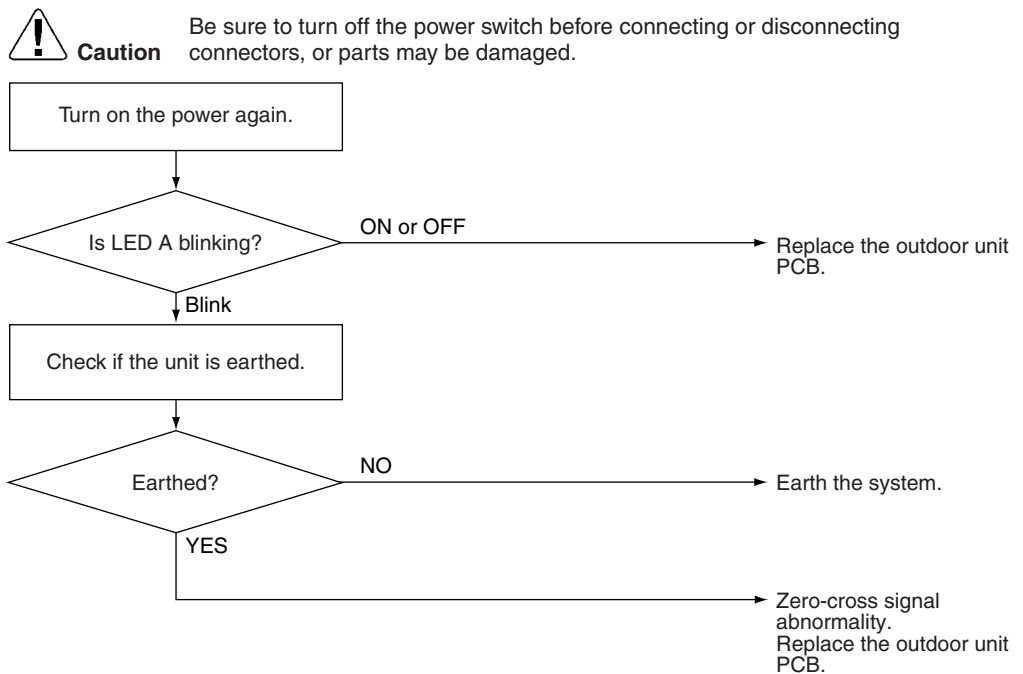

(R19727)

2.16 OL Activation (Compressor Overload)

Error Code	E5
Method of Error Detection	A compressor overload is detected through compressor OL.
Error Decision Conditions	<ul style="list-style-type: none">■ If the error repeats, the system is shut down.■ Reset condition: Continuous run for about 60 minutes without any other error
Supposed Causes	<ul style="list-style-type: none">■ Disconnection of discharge pipe thermistor■ Defective discharge pipe thermistor■ Disconnection of connector S40 or relay connector for OL (Q1M)■ Disconnection of 2 terminals of OL (Q1M)■ Defective OL (Q1M)■ Broken OL harness■ Defective electronic expansion valve or coil■ Defective four way valve or coil■ Defective outdoor unit PCB■ Refrigerant shortage■ Water mixed in refrigerant■ Defective stop valve

Troubleshooting



Check No.01
 Refer to P.183



Check No.12
 Refer to P.185

Check No.13
 Refer to P.186

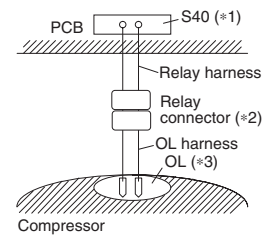
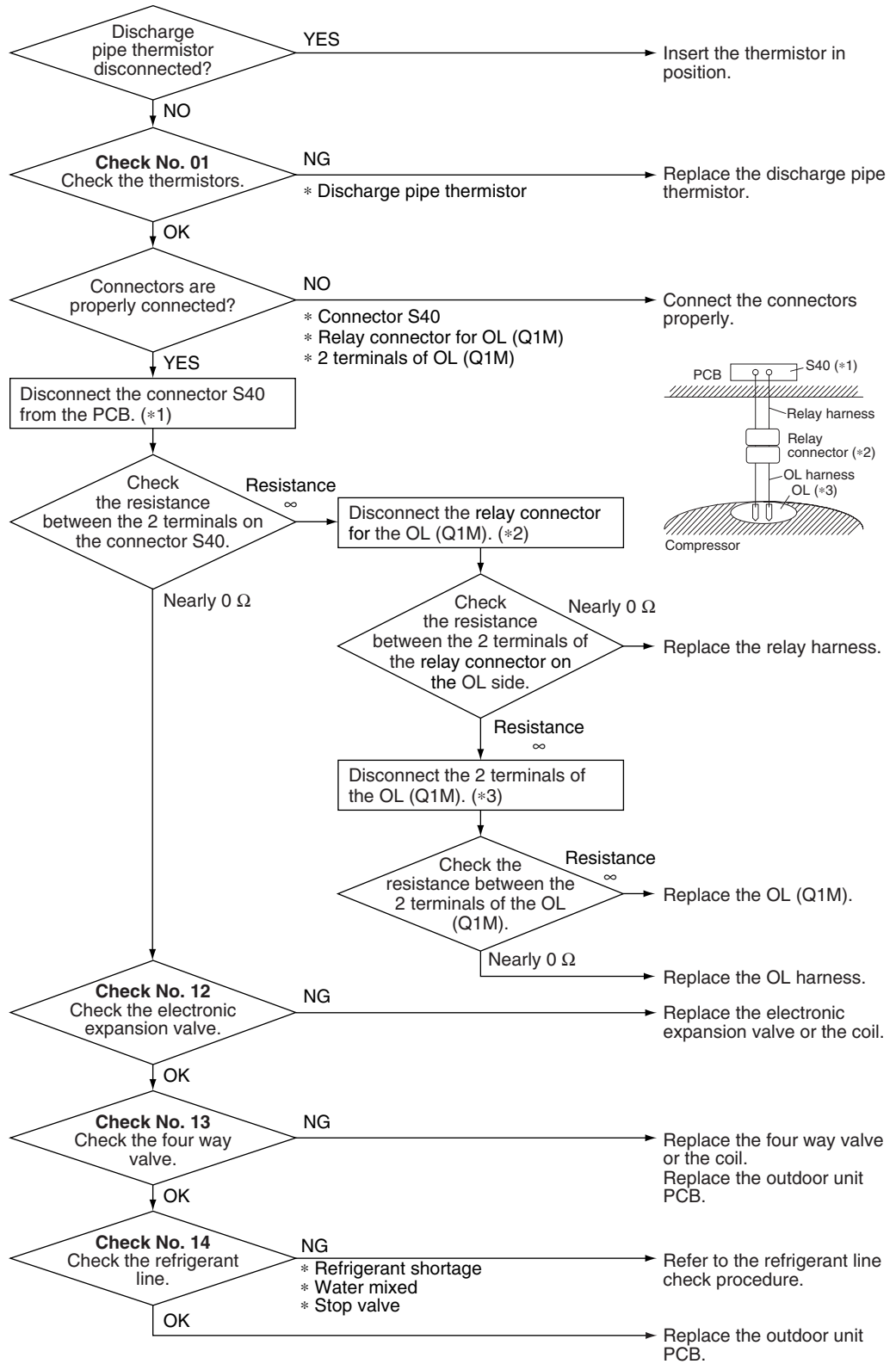
Check No.14
 Refer to P.186

 **Caution** Be sure to turn off the power switch before connecting or disconnecting connectors, or parts may be damaged.



 **Note:** OL (Q1M) activating temperature: 120°C
 OL (Q1M) recovery temperature: 95°C

(R19728)

2.17 Compressor Lock

Error Code	E6
Method of Error Detection	A compressor lock is detected by checking the compressor running condition through the position detection circuit.
Error Decision Conditions	<ul style="list-style-type: none"> ■ Operation stops due to overcurrent. ■ If the error repeats, the system is shut down. ■ Reset condition: Continuous run for about 11 minutes without any other error
Supposed Causes	<ul style="list-style-type: none"> ■ Compressor locked ■ Compressor harness disconnected

Troubleshooting

Check No.15
 Refer to P.187

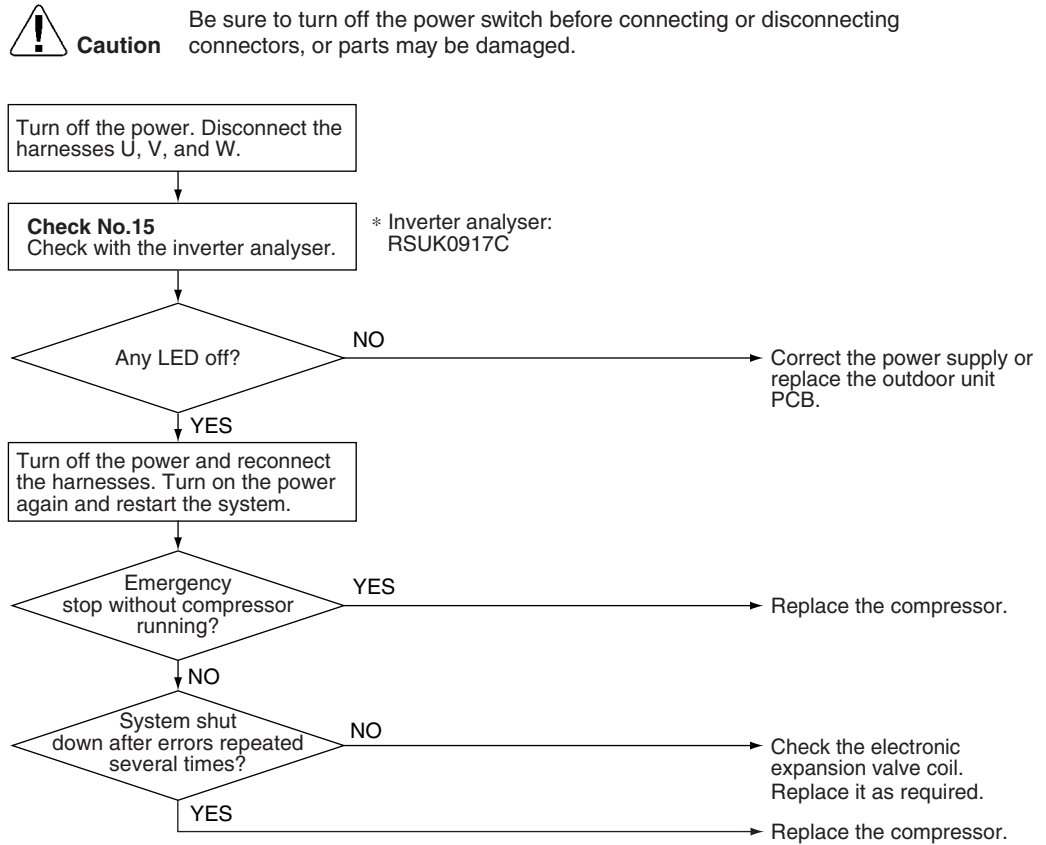

(R19477)

2.18 DC Fan Lock

Error Code	E7
Method of Error Detection	An error is determined with the high-voltage fan motor rotation speed detected by the Hall IC.
Error Decision Conditions	<ul style="list-style-type: none"> ■ The fan does not start in 60 seconds even when the fan motor is running. ■ If the error repeats, the system is shut down. ■ Reset condition: Continuous run for about 11 minutes without any other error
Supposed Causes	<ul style="list-style-type: none"> ■ Disconnection of the fan motor ■ Foreign matters stuck in the fan ■ Defective fan motor ■ Fuse for fan motor on the outdoor unit PCB is blown out. ■ Defective outdoor unit PCB

Troubleshooting

Check No.16
 Refer to P.189

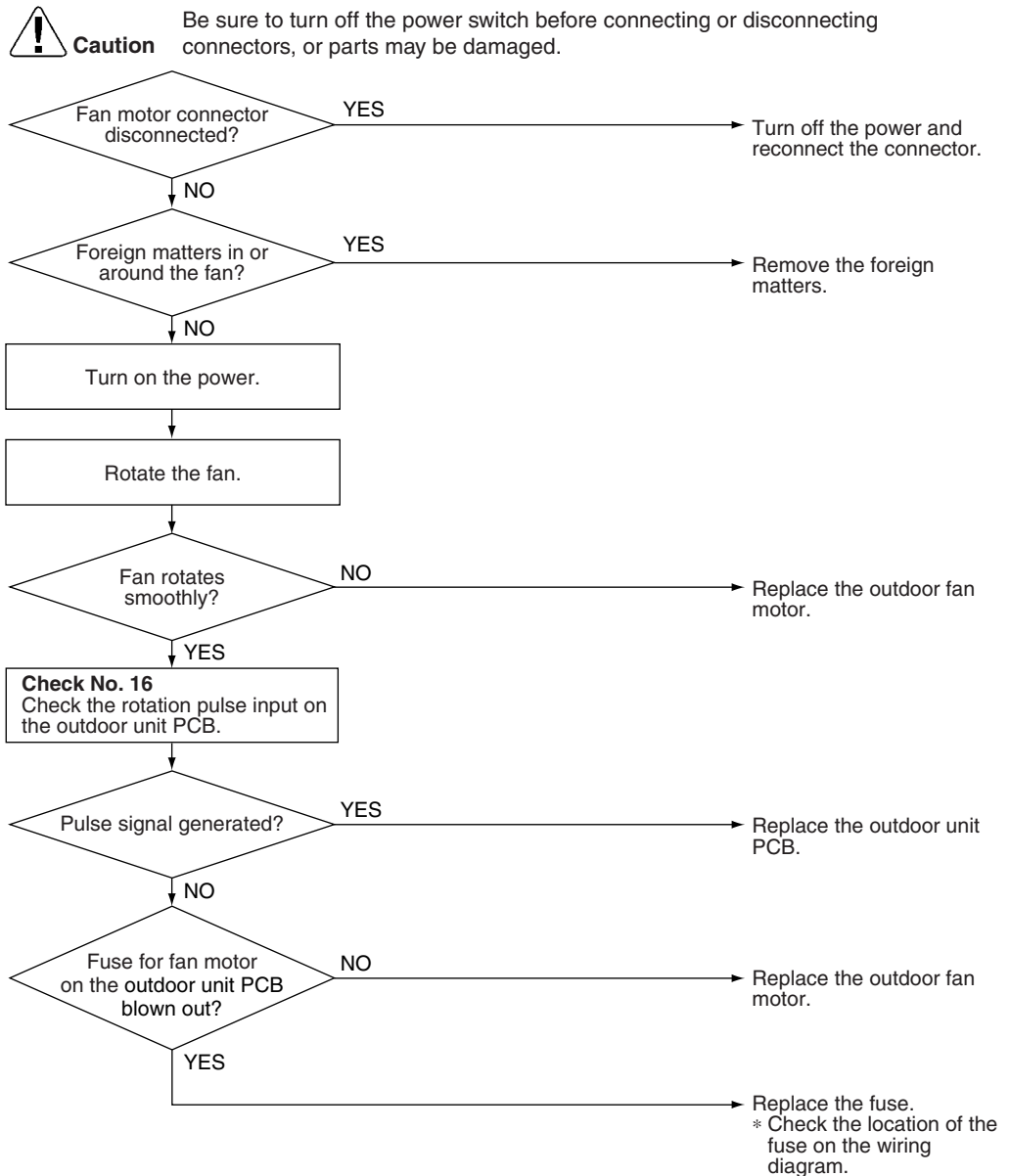

(R20202)

2.19 Input Overcurrent Detection

Error Code	E8
Method of Error Detection	An input overcurrent is detected by checking the input current value with the compressor running.
Error Decision Conditions	The current exceeds 21 A for 2.5 seconds with the compressor running. (The upper limit of the current decreases when the outdoor temperature exceeds a certain level.)
Supposed Causes	<ul style="list-style-type: none"> ■ Outdoor temperature is out of operation range. ■ Defective compressor ■ Defective power module ■ Defective outdoor unit PCB ■ Short circuit

Troubleshooting

Check No.15
 Refer to P.187

Check No.17
 Refer to P.190

Check No.18
 Refer to P.190

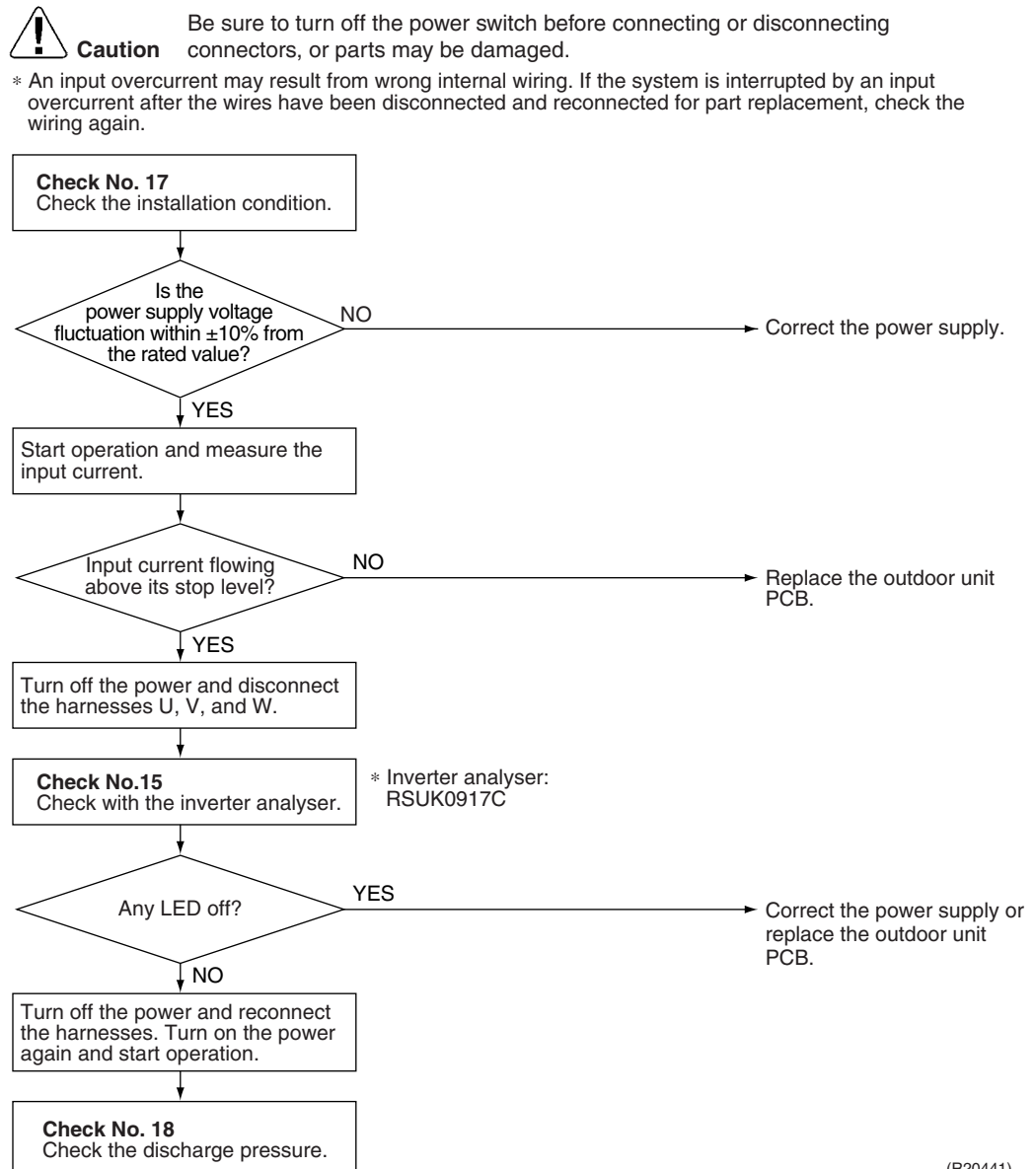

(R20441)

2.20 Four Way Valve Abnormality

Error Code	EA
Method of Error Detection	The room temperature thermistor and the indoor heat exchanger thermistor are checked if they function within their normal ranges in each operation mode.
Error Decision Conditions	<p>A following condition continues over 10 minutes after operating for 5 minutes.</p> <p><Cooling / Dry> A – B < -5°C</p> <p><Heating> B – A < -5°C</p> <p>A: Room thermistor temperature B: Indoor heat exchanger temperature</p> <ul style="list-style-type: none">■ If the error repeats, the system is shut down.■ Reset condition: Continuous run for about 60 minutes without any other error
Supposed Causes	<ul style="list-style-type: none">■ Disconnection of four way valve coil■ Defective four way valve, coil, or harness■ Defective outdoor unit PCB■ Defective thermistor■ Refrigerant shortage■ Water mixed in refrigerant■ Defective stop valve

Troubleshooting



Check No.01
Refer to P.183



Check No.13
Refer to P.186



Check No.14
Refer to P.186



Caution Be sure to turn off the power switch before connecting or disconnecting connectors, or parts may be damaged.

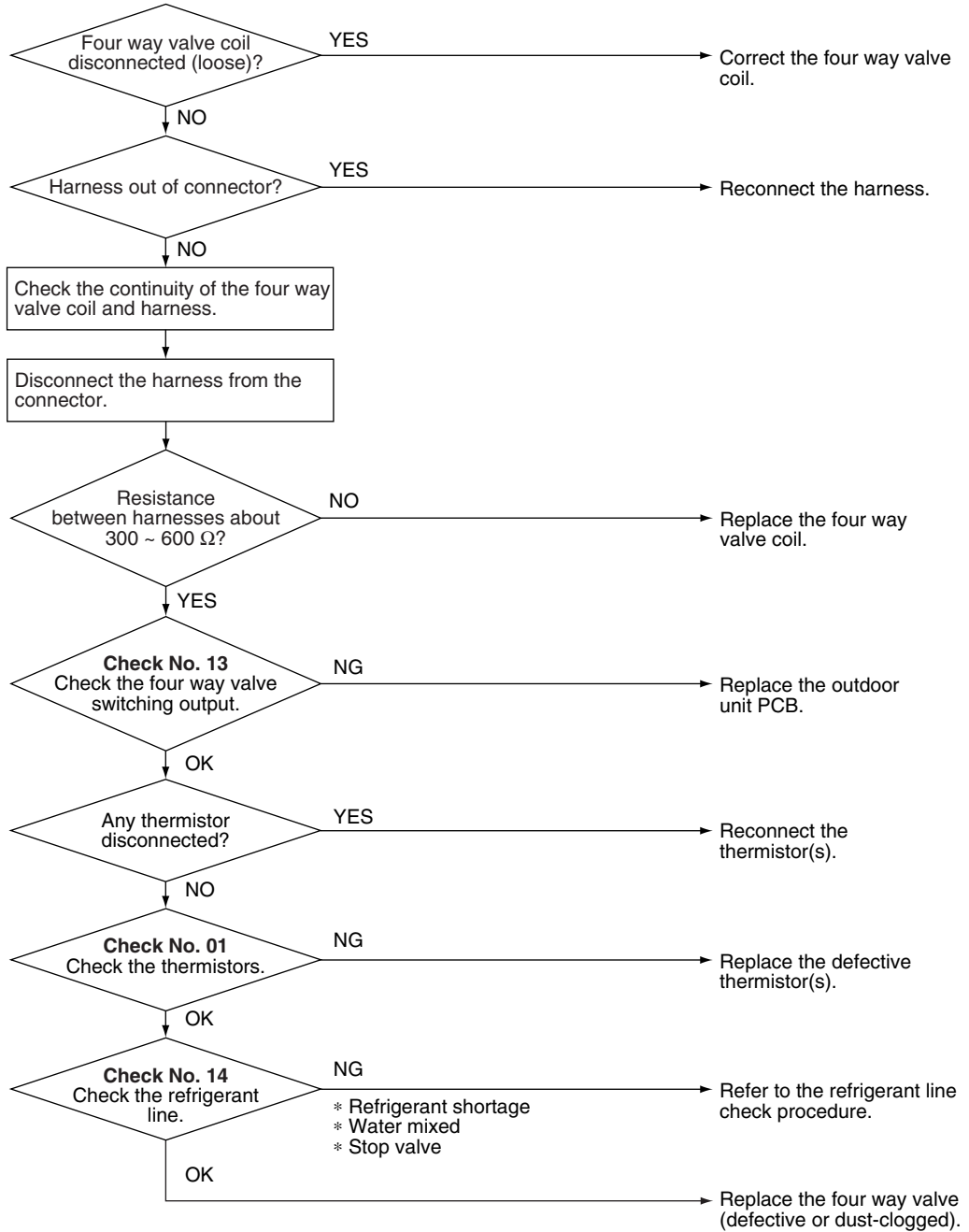



(R19729)

2.21 Discharge Pipe Temperature Control

Error Code	F3
Method of Error Detection	An error is determined with the temperature detected by the discharge pipe thermistor.
Error Decision Conditions	<ul style="list-style-type: none"> ■ If the temperature detected by the discharge pipe thermistor rises above 115°C, the compressor stops. ■ The error is cleared when the discharge pipe temperature has dropped below 85°C. ■ If the error repeats, the system is shut down. ■ Reset condition: Continuous run for about 60 minutes without any other error
Supposed Causes	<ul style="list-style-type: none"> ■ Defective discharge pipe thermistor (Defective outdoor heat exchanger thermistor or outdoor temperature thermistor) ■ Defective electronic expansion valve or coil ■ Refrigerant shortage ■ Defective four way valve ■ Water mixed in refrigerant ■ Defective stop valve ■ Defective outdoor unit PCB

Troubleshooting

-  **Check No.01**
Refer to P.183
-  **Check No.12**
Refer to P.185
-  **Check No.14**
Refer to P.186

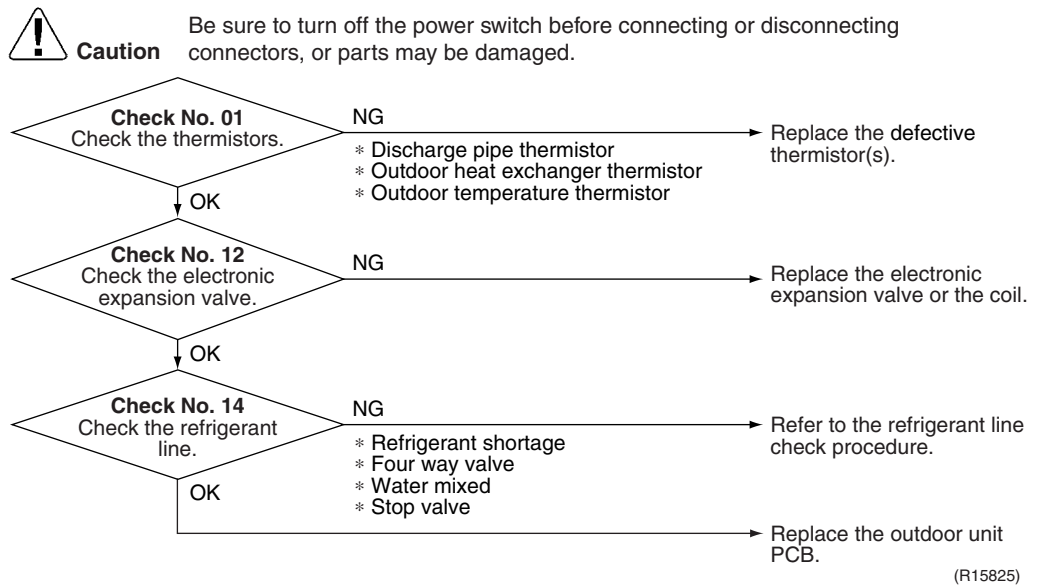

2.22 High Pressure Control in Cooling

Error Code	F6
Method of Error Detection	High-pressure control (operation halt, frequency drop, etc.) is activated in cooling operation if the temperature sensed by the outdoor heat exchanger thermistor exceeds the limit.
Error Decision Conditions	<ul style="list-style-type: none"> ■ The temperature sensed by the outdoor heat exchanger thermistor rises above about 54.5°C. ■ The error is cleared when the temperature drops below about 47.5°C.
Supposed Causes	<ul style="list-style-type: none"> ■ The installation space is not large enough. ■ Dirty outdoor heat exchanger ■ Defective outdoor fan motor ■ Defective stop valve ■ Defective electronic expansion valve or coil ■ Defective outdoor heat exchanger thermistor ■ Defective outdoor unit PCB

Troubleshooting



Check No.01
 Refer to P.183

Check No.12
 Refer to P.185

Check No.17
 Refer to P.190

Check No.18
 Refer to P.190

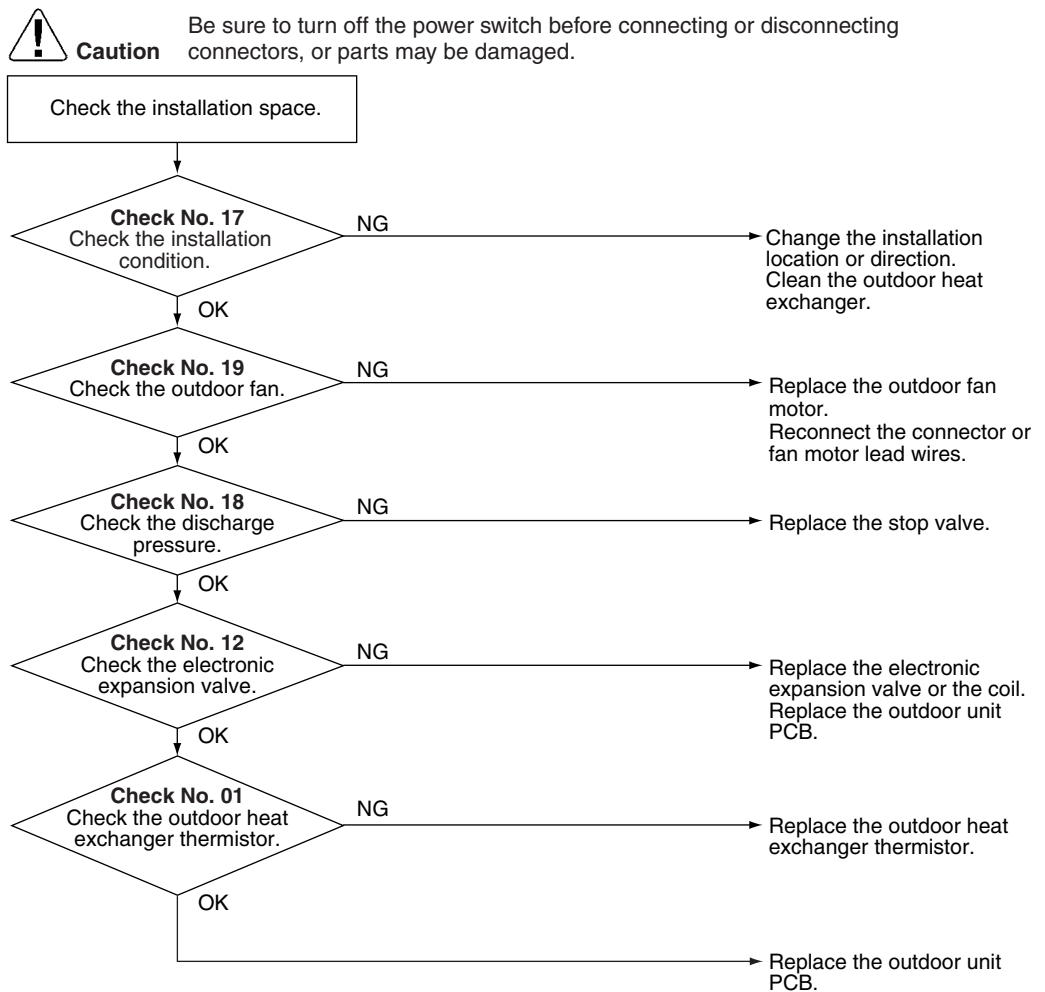

Check No.19
 Refer to P.191



(R15667)

2.23 Compressor System Sensor Abnormality

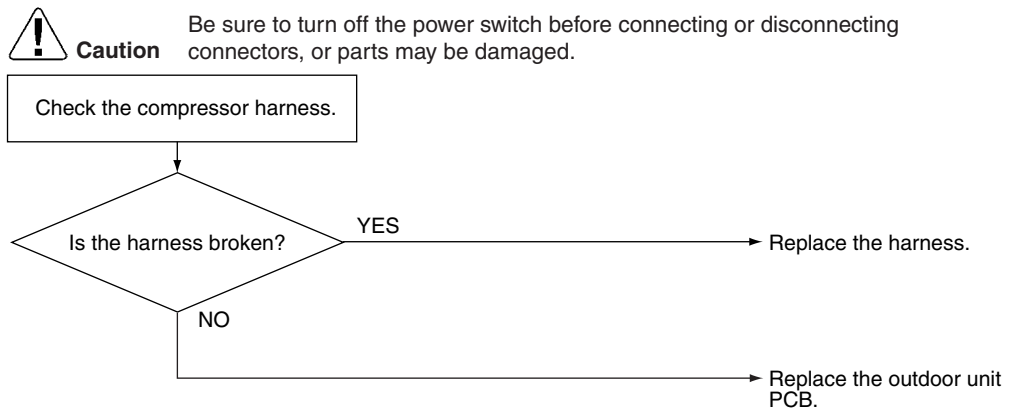
Error Code	H0
Method of Error Detection	The system checks the DC voltage before the compressor starts.
Error Decision Conditions	<ul style="list-style-type: none"> ■ The voltage converted from the DC current before compressor start-up is out of the range 0.5 ~ 4.5 V. ■ The DC voltage before compressor start-up is below 50 V.
Supposed Causes	<ul style="list-style-type: none"> ■ Broken or disconnected harness ■ Defective outdoor unit PCB
Troubleshooting	



(R20445)

2.24 Power Factor Correction Circuit Abnormality

Error Code

H0

Method of Error Detection

Overcurrent or overvoltage is detected on power factor correction circuit.

Error Decision Conditions

When the abnormal signal is detected from the power factor correction circuit.

Supposed Causes

- Defective reactor
- Reactor harness disconnection or wire breakage
- Defective outdoor unit PCB

Troubleshooting



Caution

Be sure to turn off the power switch before connecting or disconnecting connectors, or parts may be damaged.

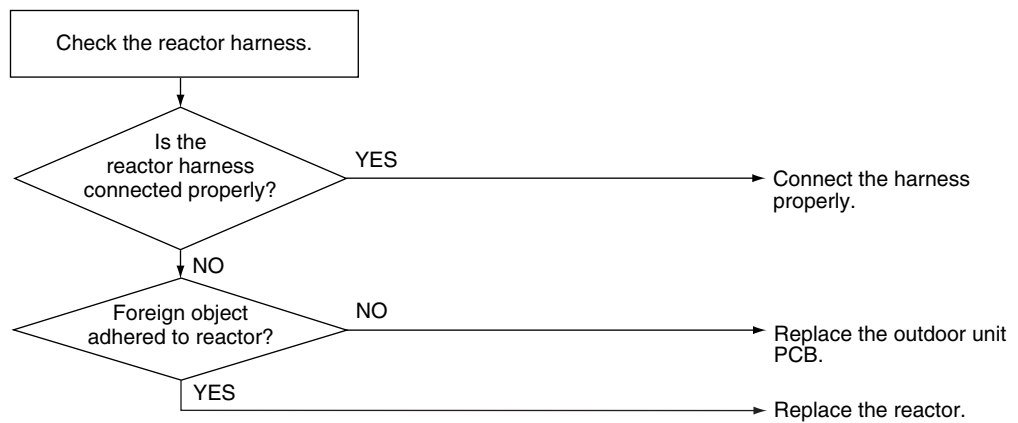

(R20211)

2.25 Damper Abnormality

Error Code	H1
Method of Error Detection	Damper abnormality is detected by improper behavior of the limit switch (LS) in the humidifying unit.
Error Decision Conditions	No ON/OFF of the limit switch is detected despite humidifying operation being started or stopped at power on or when humidifying operation (including ventilation) or MOLD PROOF operation is started.
Supposed Causes	<ul style="list-style-type: none"> ■ Damper malfunction due to icing ■ Damper being clogged with foreign object ■ Defective limit switch (including wiring error) ■ Defective damper motor

Troubleshooting

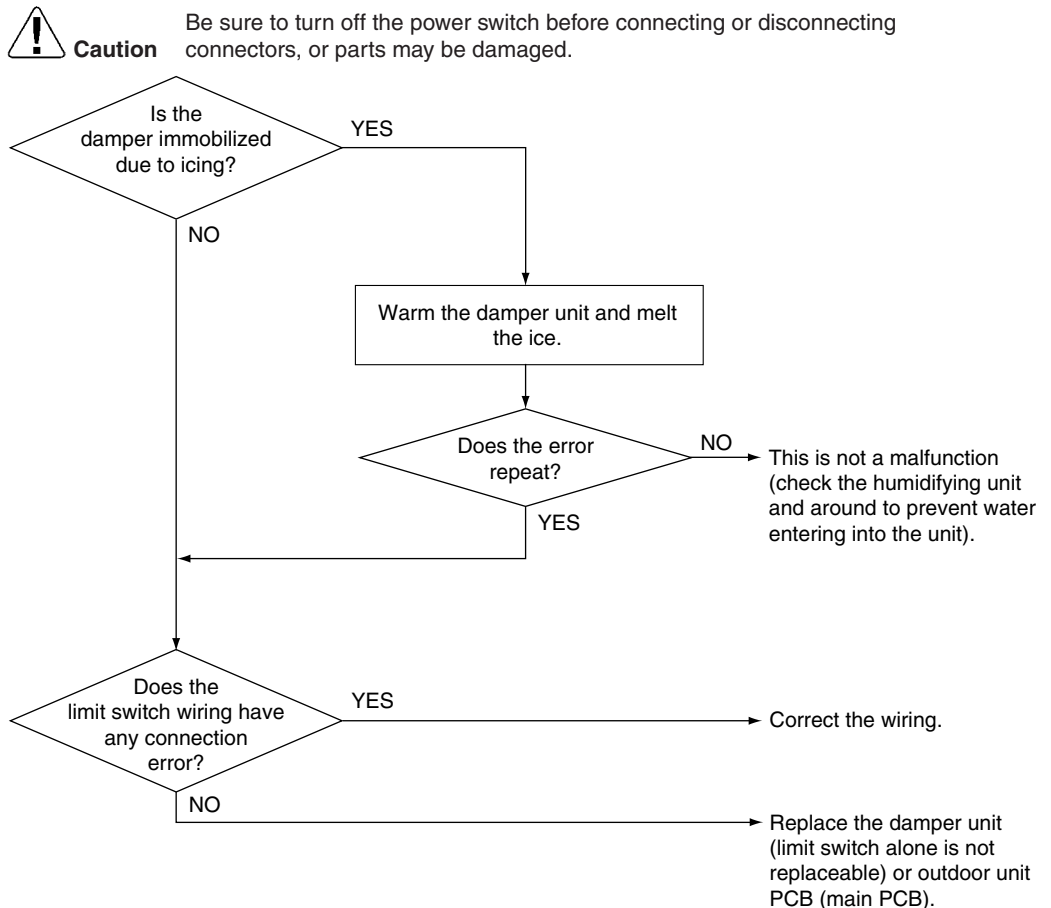

(R24976)

2.26 Position Sensor Abnormality

Error Code	H6
Method of Error Detection	A compressor start-up failure is detected by checking the compressor running condition through the position detection circuit.
Error Decision Conditions	<ul style="list-style-type: none">■ When the compressor does not run for 15 seconds after receiving operation start command.■ If the error repeats, the system is shut down.■ Reset condition: Continuous run for about 11 minutes without any other error
Supposed Causes	<ul style="list-style-type: none">■ Disconnection of the compressor relay cable■ Defective compressor■ Defective outdoor unit PCB■ Start-up failure caused by the closed stop valve■ Input voltage is outside the specified range.

Troubleshooting

 **Check No.15**
Refer to P.187

 **Check No.18**
Refer to P.190

 **Check No.20**
Refer to P.191

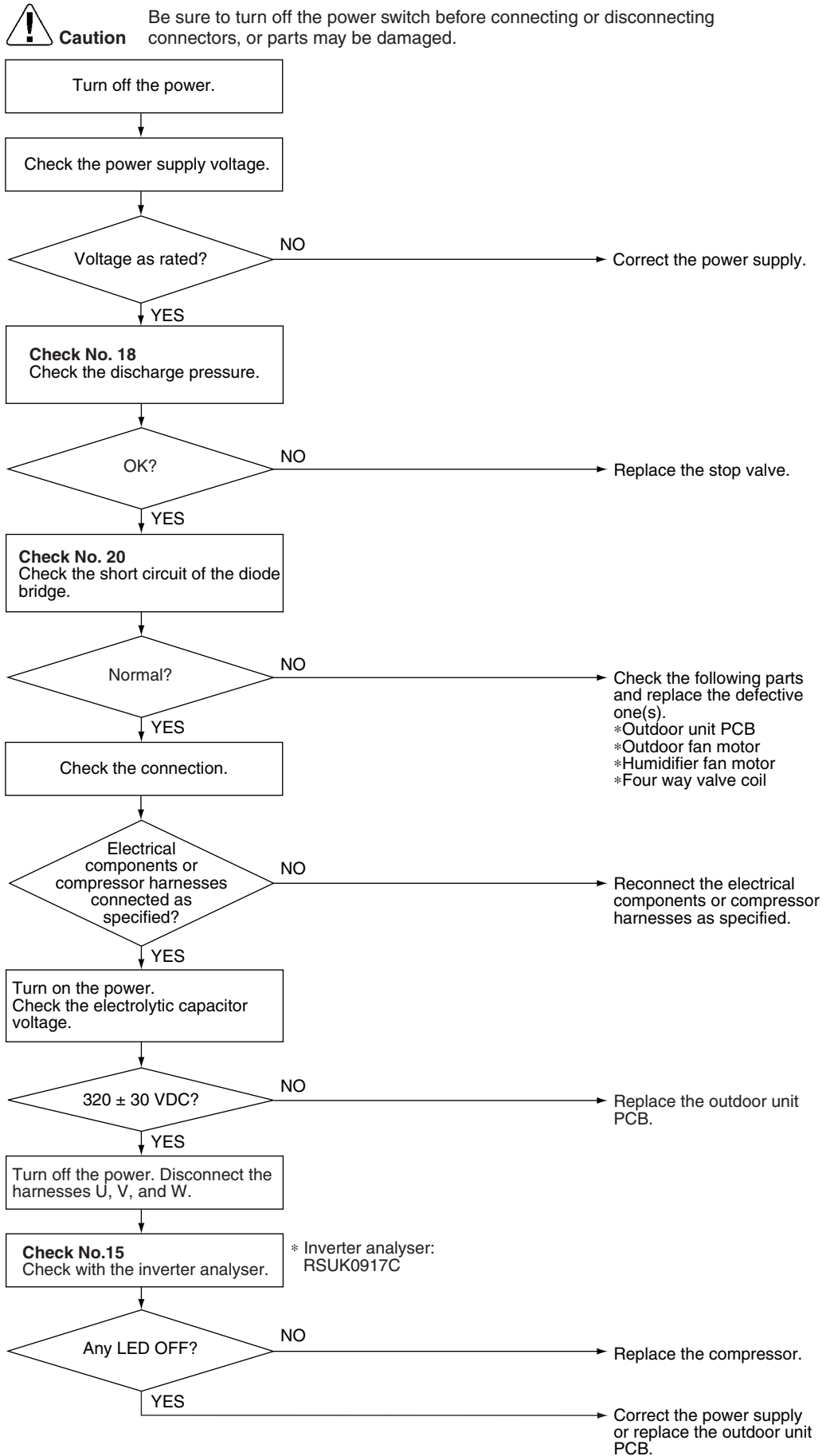

(R19730)

2.27 Thermistor or Related Abnormality (Outdoor Unit)

Error Code	H9, J3, J6, J8, P4
Method of Error Detection	This fault is identified based on the thermistor input voltage to the microcomputer. A thermistor fault is identified based on the temperature sensed by each thermistor.
Error Decision Conditions	<ul style="list-style-type: none"> ■ The thermistor input voltage is 4.98 V and more or 0.02 V and less for 5 seconds with the power on. ■ J3 error is judged if the discharge pipe temperature is lower than the heat exchanger temperature.
Supposed Causes	<ul style="list-style-type: none"> ■ Disconnection of the connector for the thermistor ■ Thermistor corresponding to the error code is defective. ■ Defective heat exchanger thermistor in the case of J3 error (outdoor heat exchanger thermistor in cooling operation, or indoor heat exchanger thermistor in heating operation) ■ Defective outdoor unit PCB
Troubleshooting	<p>In case of P4 (Radiation fin thermistor)</p> <p> Caution Be sure to turn off the power switch before connecting or disconnecting connectors, or parts may be damaged.</p> <p>Replace the outdoor unit PCB.</p>

Troubleshooting

Check No.01
 Refer to P.183

■ In case of H9, J3, J6, J8



Caution Be sure to turn off the power switch before connecting or disconnecting connectors, or parts may be damaged.

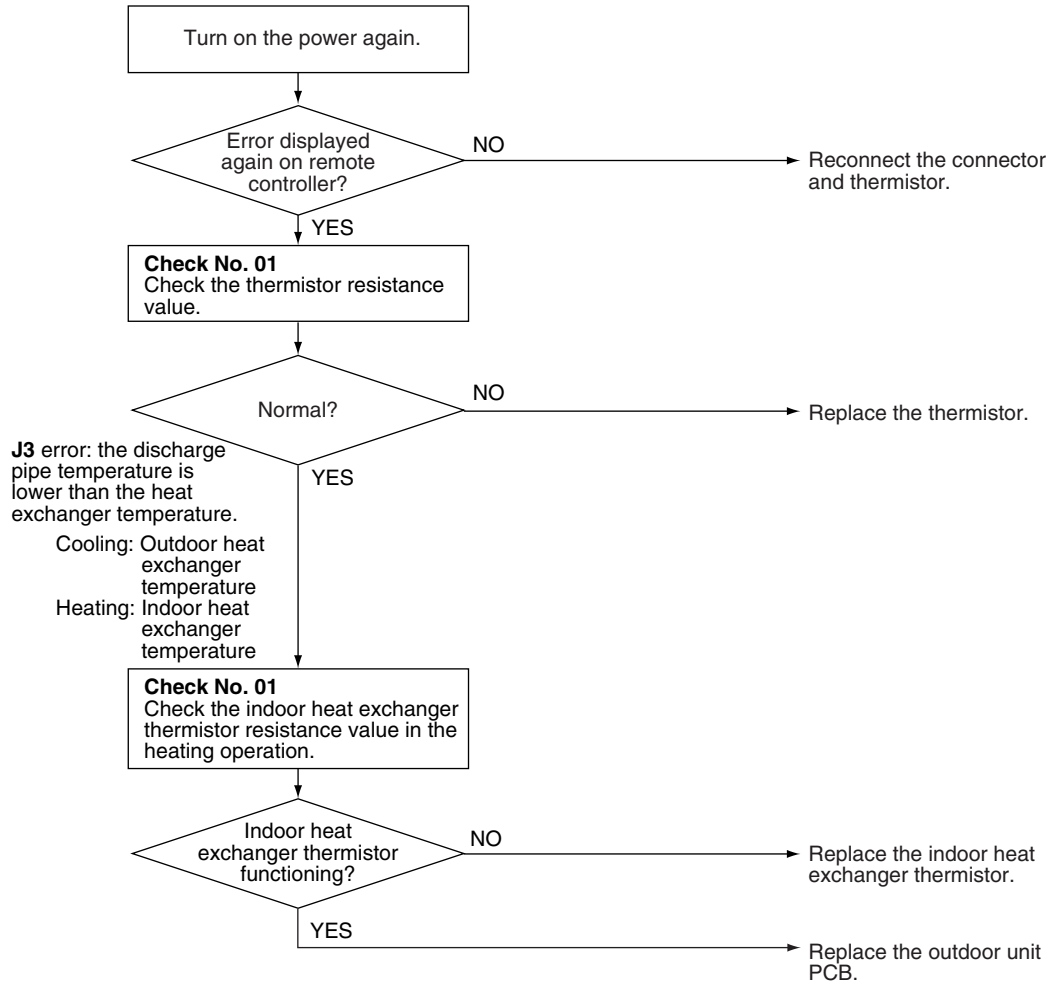



(R19731)

- H9:** Outdoor temperature thermistor
- J3:** Discharge pipe thermistor
- J6:** Outdoor heat exchanger thermistor
- J8:** Liquid pipe thermistor

2.28 Electrical Box Temperature Rise

Error Code	L3						
Method of Error Detection	An electrical box temperature rise is detected by checking the radiation fin thermistor with the compressor off.						
Error Decision Conditions	<ul style="list-style-type: none"> ■ With the compressor off, the radiation fin temperature is above A°C. ■ The error is cleared when the radiation fin temperature drops below B°C. ■ To cool the electrical components, the outdoor fan starts when the radiation fin temperature rises above C°C and stops when it drops below B°C. 						
	<table border="1"> <thead> <tr> <th>A (°C)</th> <th>B (°C)</th> <th>C (°C)</th> </tr> </thead> <tbody> <tr> <td>122</td> <td>64</td> <td>113</td> </tr> </tbody> </table>	A (°C)	B (°C)	C (°C)	122	64	113
A (°C)	B (°C)	C (°C)					
122	64	113					
Supposed Causes	<ul style="list-style-type: none"> ■ Defective outdoor fan motor ■ Short circuit ■ Defective radiation fin thermistor ■ Disconnection of connector ■ Defective outdoor unit PCB 						

Troubleshooting

- 
Check No.17
Refer to P.190
- 
Check No.19
Refer to P.191

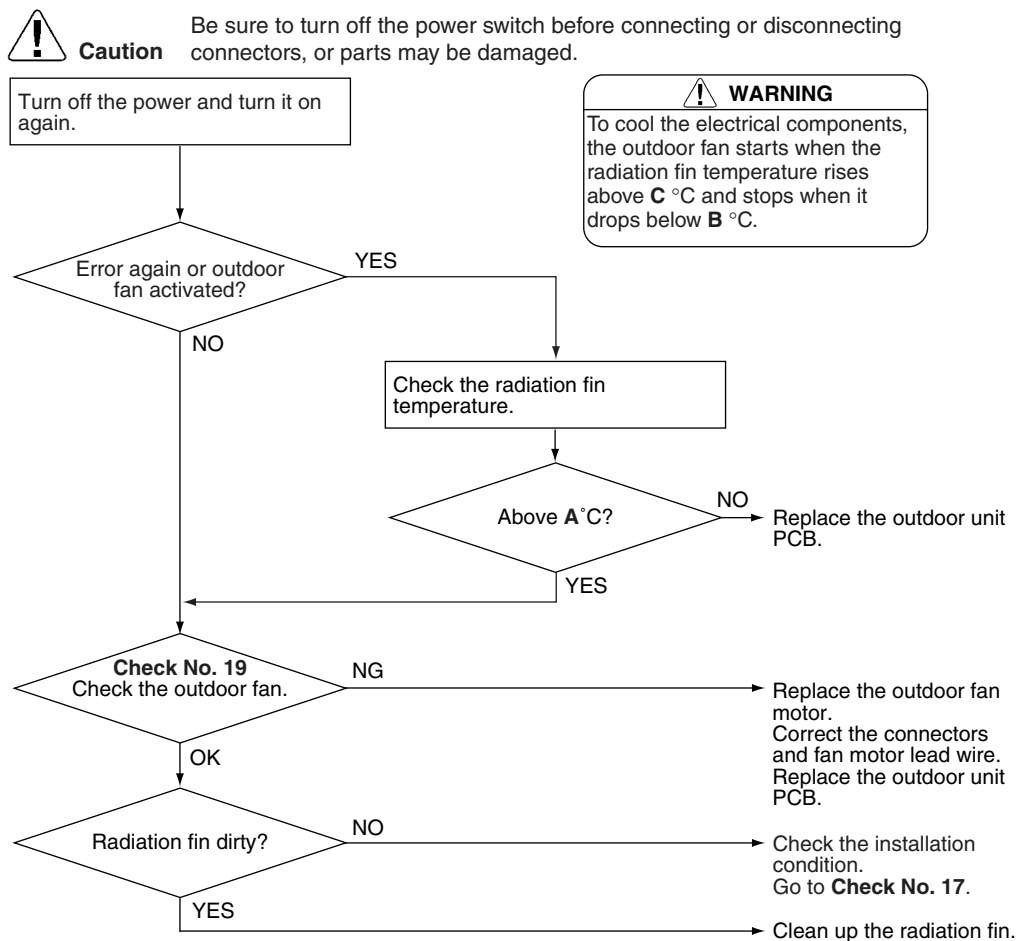

(R19556)

2.29 Radiation Fin Temperature Rise

Error Code	L4				
Method of Error Detection	A radiation fin temperature rise is detected by checking the radiation fin thermistor with the compressor on.				
Error Decision Conditions	<ul style="list-style-type: none"> ■ The radiation fin temperature with the compressor on is above A°C. ■ The error is cleared when the radiation fin temperature drops below B°C. ■ If the error repeats, the system is shut down. ■ Reset condition: Continuous run for about 60 minutes without any other error <table border="1" style="margin-left: 20px;"> <thead> <tr> <th>A (°C)</th> <th>B (°C)</th> </tr> </thead> <tbody> <tr> <td style="text-align: center;">86</td> <td style="text-align: center;">57</td> </tr> </tbody> </table>	A (°C)	B (°C)	86	57
A (°C)	B (°C)				
86	57				
Supposed Causes	<ul style="list-style-type: none"> ■ Defective outdoor fan motor ■ Short circuit ■ Defective radiation fin thermistor ■ Disconnection of connector ■ Defective outdoor unit PCB ■ Silicone grease is not applied properly on the radiation fin after replacing the outdoor unit PCB. 				

Troubleshooting



Check No.17
Refer to P.190



Check No.19
Refer to P.191

**Caution**

Be sure to turn off the power switch before connecting or disconnecting connectors, or parts may be damaged.

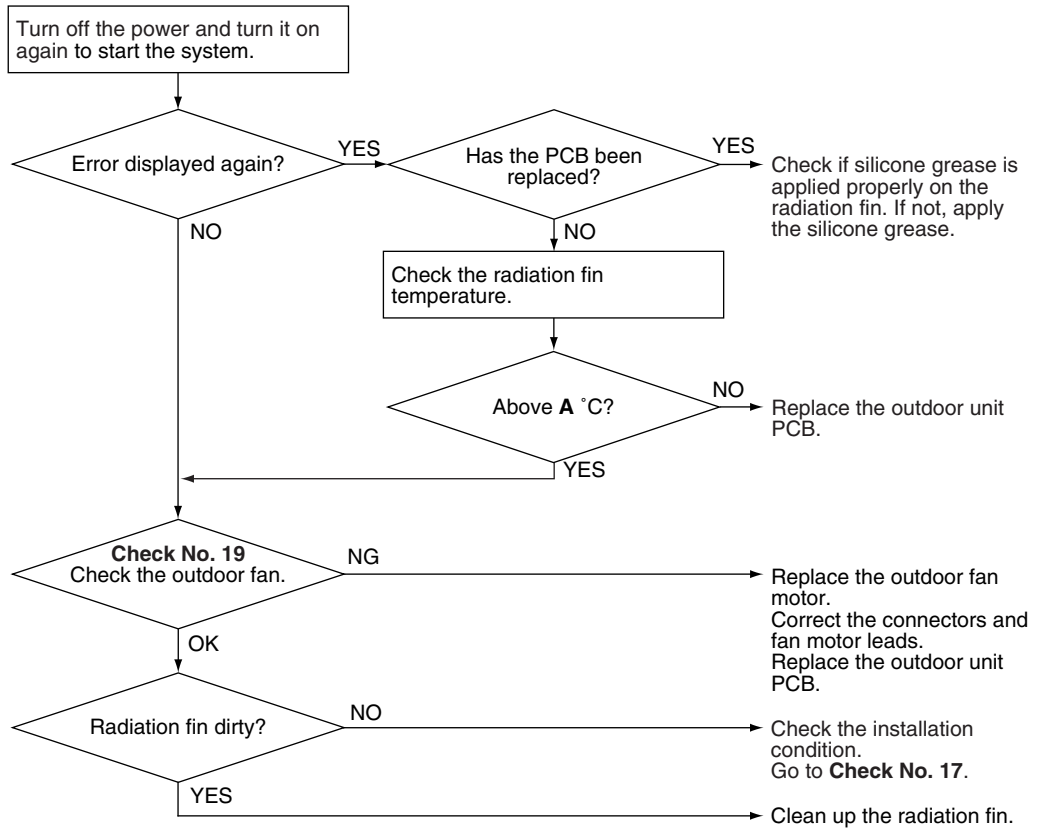

(R24980)

A (°C)
86



Note: Refer to Silicone Grease on Power Transistor / Diode Bridge on page 200 for detail.

2.30 Output Overcurrent Detection

Error Code	L5
Method of Error Detection	An output overcurrent is detected by checking the current that flows in the inverter DC section.
Error Decision Conditions	<ul style="list-style-type: none">■ A position signal error occurs while the compressor is running.■ A rotation speed error occurs while the compressor is running.■ An output overcurrent signal is fed from the output overcurrent detection circuit to the microcomputer.■ If the error repeats, the system is shut down.■ Reset condition: Continuous run for about 11 minutes without any other error
Supposed Causes	<ul style="list-style-type: none">■ Poor installation condition■ Closed stop valve■ Defective power module■ Wrong internal wiring■ Abnormal power supply voltage■ Defective outdoor unit PCB■ Defective compressor

Troubleshooting



Check No.15
Refer to P.187



Check No.17
Refer to P.190



Check No.18
Refer to P.190



Check No.22
Refer to P.192



Caution

Be sure to turn off the power switch before connecting or disconnecting connectors, or parts may be damaged.

* An output overcurrent may result from wrong internal wiring. If the system is interrupted by an output overcurrent after the wires have been disconnected and reconnected for part replacement, check the wiring again.

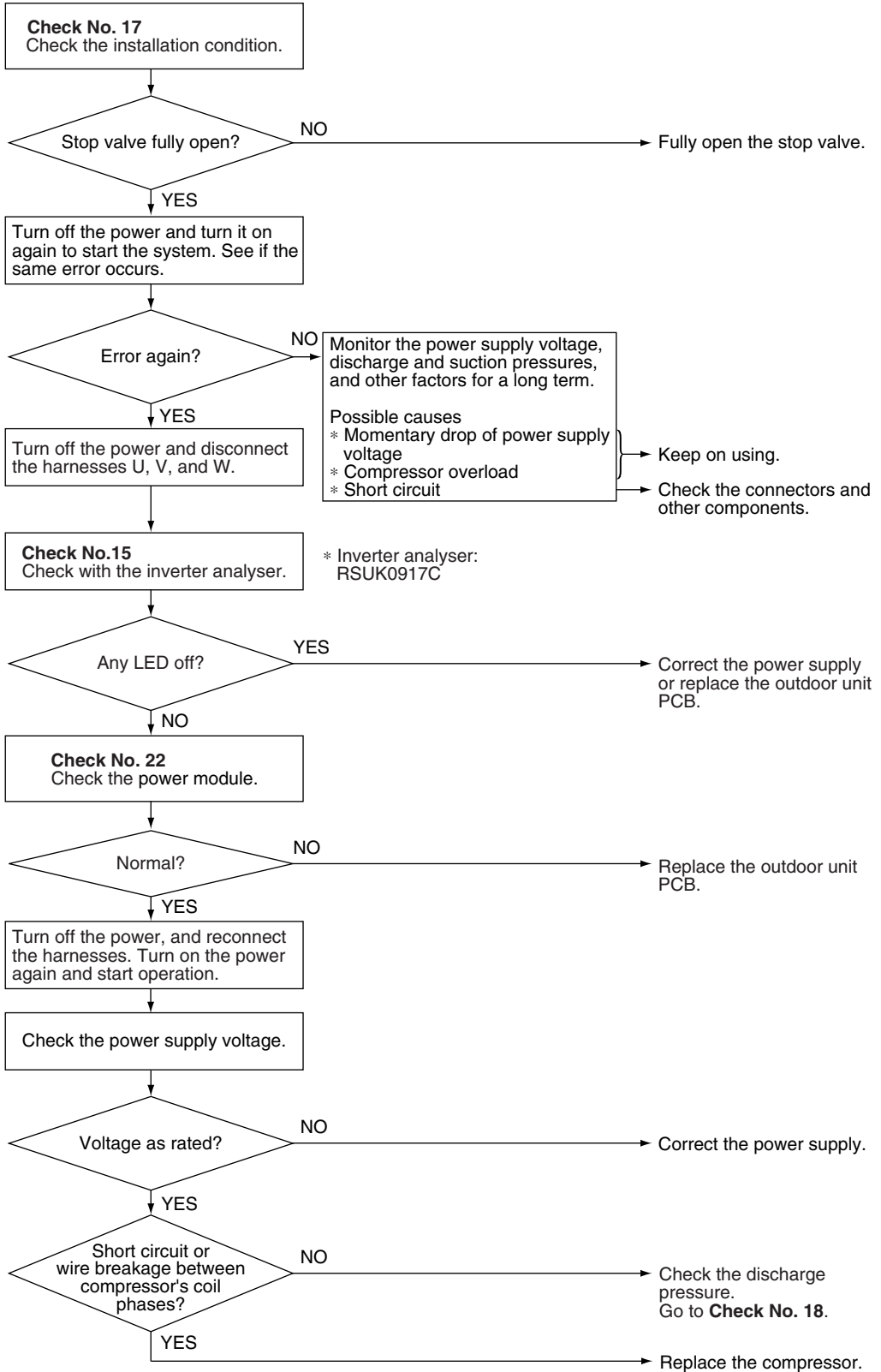

(R19545)

2.31 Humidifier Fan Motor System Abnormality / Fan Lock

Error Code	P9
Method of Error Detection	During humidifier fan motor running, fan motor system abnormality is identified based on the fan motor rotation speed detected by the Hall IC.
Error Decision Conditions	The fan motor rotation speed does not reach 100 rpm within 12 seconds after starting.
Supposed Causes	<ul style="list-style-type: none"> ■ Defective humidifier fan motor ■ Breakage of relay harness or loose connector ■ Detection fault of fan motor rotation speed due to defective outdoor unit PCB

Troubleshooting



Check No.16
Refer to P.189

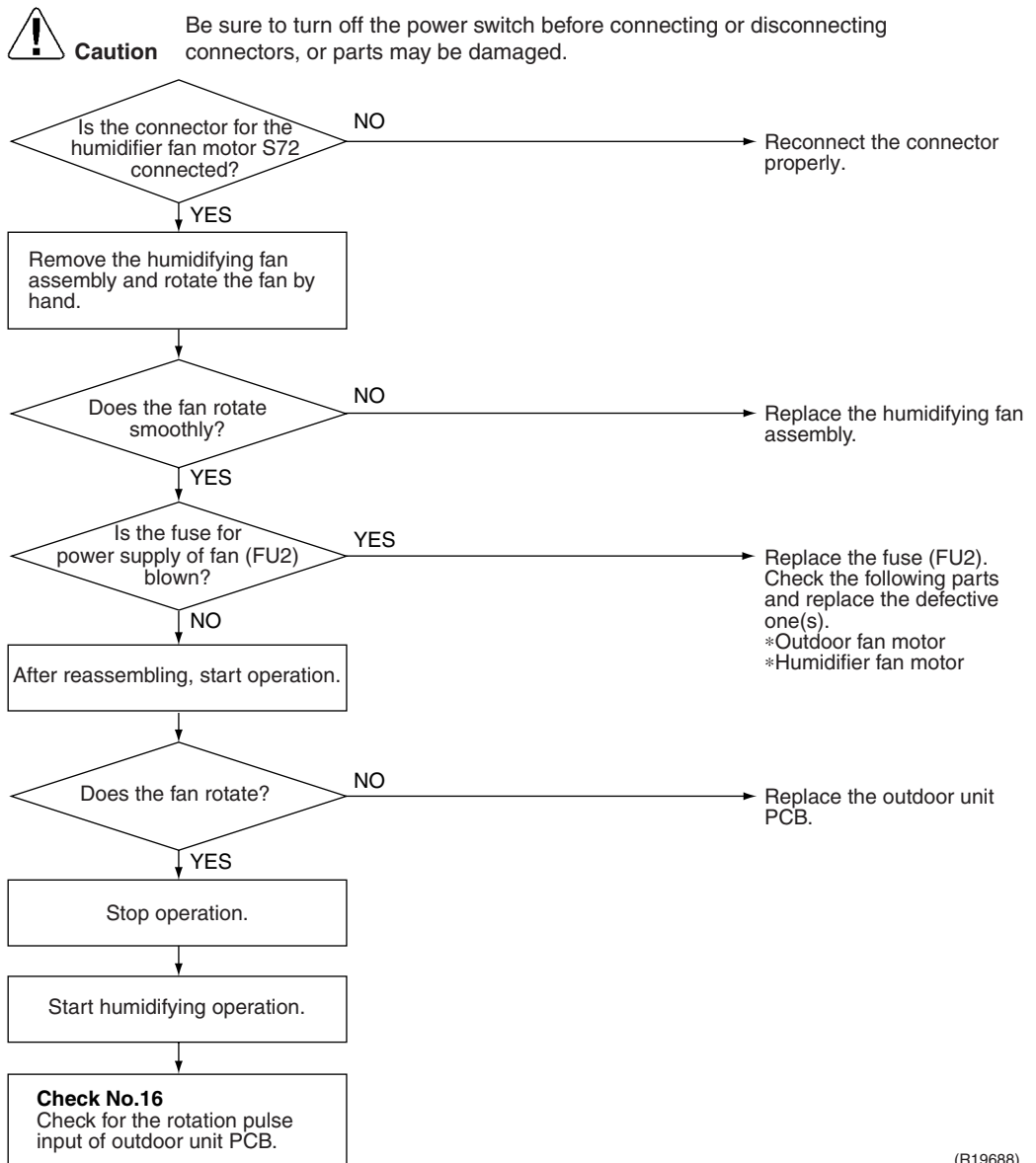

(R19688)



Note: FU2 is commonly used for the outdoor fan motor, humidifier fan motor, and the four way valve coil.

2.32 Heater Wire Abnormality

Error Code

PA

Method of Error Detection

An error is identified when the outlet temperature of humidifying fan does not reach a certain temperature within a given time after the heater is turned on.

Error Decision Conditions

The temperature detected by the humidifying thermistor is lower than the outdoor temperature (with the heater turned off) + 6°C, and this condition continues for 30 minutes.

Supposed Causes

- Power supply voltage is extremely low.
- Breakage of heater filament
- Breakage of heater harness
- Abnormal temperature detected by outdoor temperature thermistor
- Abnormal temperature detected by humidifying thermistor
- Defective main relay
- Blown thermal fuse
- Defective heater control part

Troubleshooting



Check No.01
Refer to P.183



Caution Be sure to turn off the power switch before connecting or disconnecting connectors, or parts may be damaged.

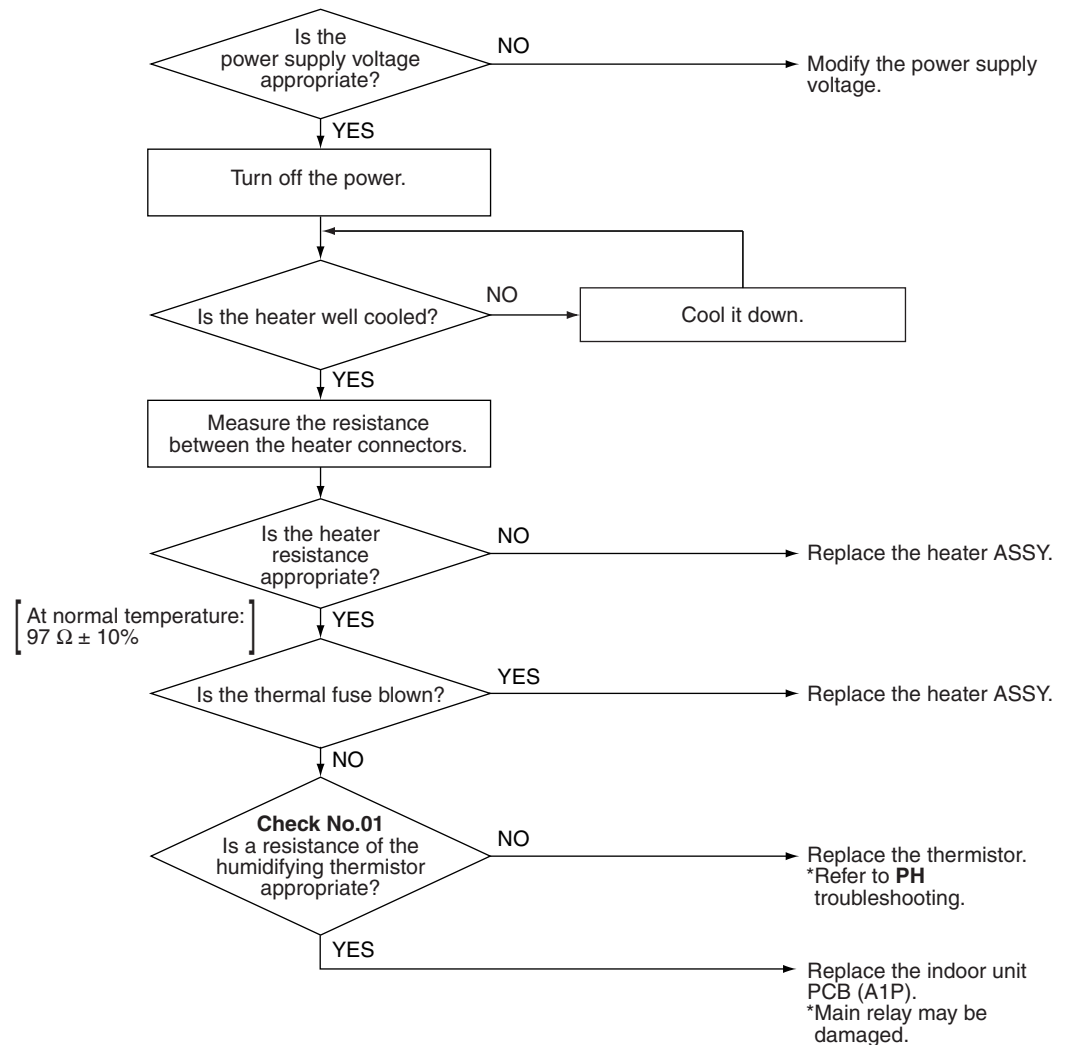

When the main relay (MRM10) is damaged, heater and rotor do not run.

(R19689)

2.33 Humidifying Thermistor Abnormality / Humidifying Heater Temperature Abnormality

Error Code	PH
Method of Error Detection	An error is identified when the temperature detected by the humidifying thermistor is abnormal.
Error Decision Conditions	<ul style="list-style-type: none">■ When the power is supplied and the thermistor input is 4.90 V and more or 0.06 V and less.■ The outlet temperature of humidifying fan is more than 90°C.
Supposed Causes	<ul style="list-style-type: none">■ Short circuit and wire breakage of humidifying thermistor■ Disconnection of connector■ Heater has a high power.■ Thermistor temperature detection error■ Defective rotor motor■ Defective hygroscopic fan motor■ Defective heater control part■ Defective humidifying fan

Troubleshooting



Check No.01
Refer to P.183



Check No.19
Refer to P.191

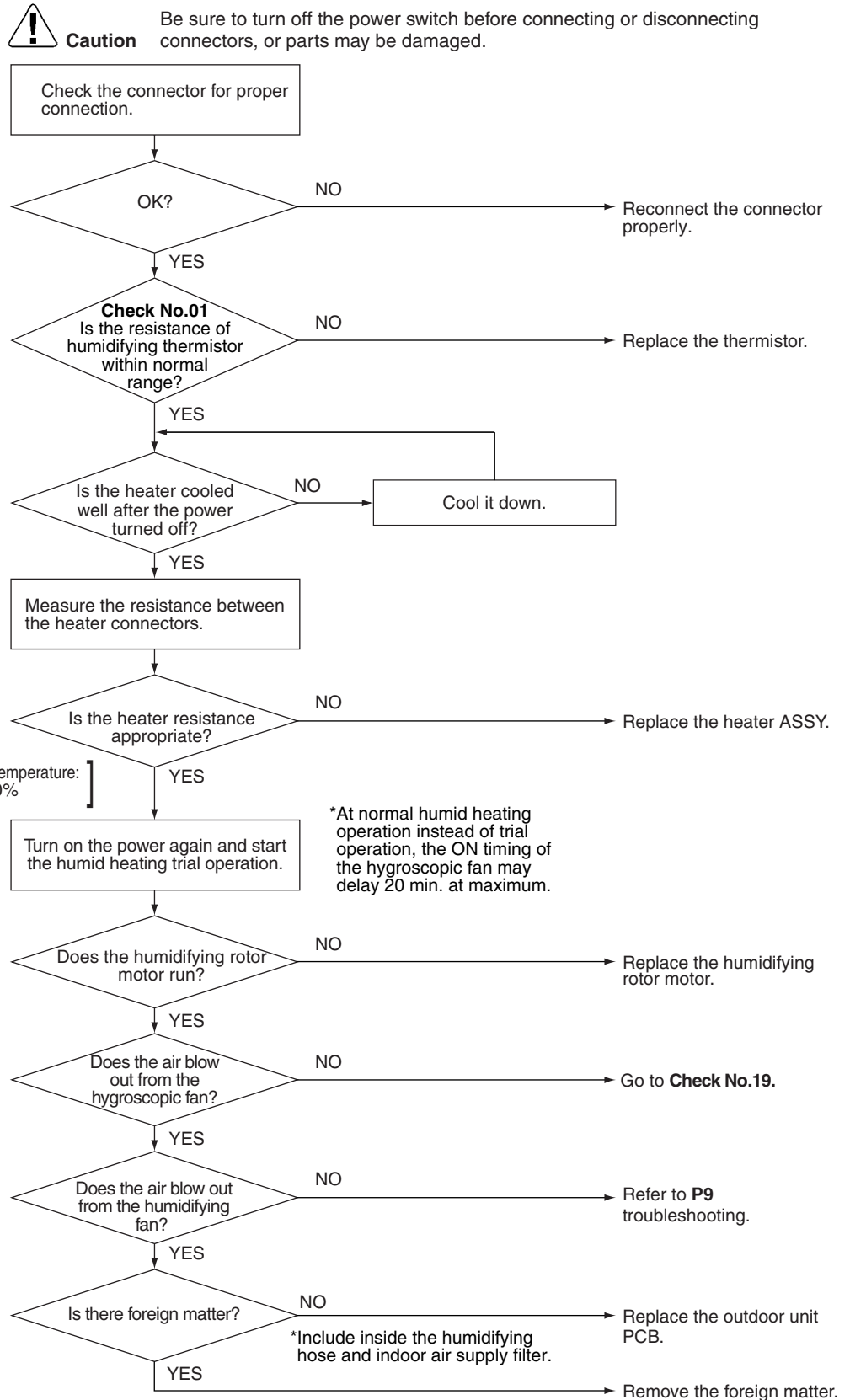

(R19690)

2.34 Refrigerant Shortage

Error Code	U0																									
Method of Error Detection	<p>Refrigerant shortage detection I: Refrigerant shortage is detected by checking the input current value and the compressor running frequency. If the refrigerant is short, the input current is lower than the normal value.</p> <p>Refrigerant shortage detection II: Refrigerant shortage is detected by checking the discharge pipe temperature and the opening of the electronic expansion valve. If the refrigerant is short, the discharge pipe temperature tends to rise.</p> <p>Refrigerant shortage detection III: Refrigerant shortage is detected by checking the difference between suction and discharge temperature.</p>																									
Error Decision Conditions	<p>Refrigerant shortage detection I: The following conditions continue for 7 minutes.</p> <ul style="list-style-type: none"> ◆ Input current × input voltage ≤ A × output frequency + B ◆ Output frequency > C <table border="1" style="margin-left: 20px;"> <thead> <tr> <th>A (-)</th> <th>B (W)</th> <th>C (Hz)</th> </tr> </thead> <tbody> <tr> <td>2800/256</td> <td>-350</td> <td>55</td> </tr> </tbody> </table> <p>Refrigerant shortage detection II: The following conditions continue for 80 seconds.</p> <ul style="list-style-type: none"> ◆ Opening of the electronic expansion valve ≥ D ◆ Discharge pipe temperature > E × target discharge pipe temperature + F <table border="1" style="margin-left: 20px;"> <thead> <tr> <th>D (pulse)</th> <th>E (-)</th> <th>F (°C)</th> </tr> </thead> <tbody> <tr> <td>470</td> <td>128/128</td> <td>20</td> </tr> </tbody> </table> <p>Refrigerant shortage detection III: When the difference of the temperature is smaller than G°C, it is regarded as refrigerant shortage.</p> <table border="1" style="margin-left: 20px;"> <thead> <tr> <th>Operation mode</th> <th>Description</th> <th>G (°C)</th> </tr> </thead> <tbody> <tr> <td rowspan="2">Cooling</td> <td>room thermistor temperature – indoor heat exchanger temperature</td> <td>4.0</td> </tr> <tr> <td>outdoor heat exchanger temperature – outdoor temperature</td> <td>4.0</td> </tr> <tr> <td rowspan="2">Heating</td> <td>indoor heat exchanger temperature – room thermistor temperature</td> <td>4.0</td> </tr> <tr> <td>outdoor temperature – outdoor heat exchanger temperature</td> <td>4.0</td> </tr> </tbody> </table> <ul style="list-style-type: none"> ■ If the error repeats, the system is shut down. ■ Reset condition: Continuous run for about 60 minutes without any other error 	A (-)	B (W)	C (Hz)	2800/256	-350	55	D (pulse)	E (-)	F (°C)	470	128/128	20	Operation mode	Description	G (°C)	Cooling	room thermistor temperature – indoor heat exchanger temperature	4.0	outdoor heat exchanger temperature – outdoor temperature	4.0	Heating	indoor heat exchanger temperature – room thermistor temperature	4.0	outdoor temperature – outdoor heat exchanger temperature	4.0
A (-)	B (W)	C (Hz)																								
2800/256	-350	55																								
D (pulse)	E (-)	F (°C)																								
470	128/128	20																								
Operation mode	Description	G (°C)																								
Cooling	room thermistor temperature – indoor heat exchanger temperature	4.0																								
	outdoor heat exchanger temperature – outdoor temperature	4.0																								
Heating	indoor heat exchanger temperature – room thermistor temperature	4.0																								
	outdoor temperature – outdoor heat exchanger temperature	4.0																								
Supposed Causes	<ul style="list-style-type: none"> ■ Disconnection of the discharge pipe thermistor, indoor or outdoor heat exchanger thermistor, room or outdoor temperature thermistor ■ Closed stop valve ■ Refrigerant shortage (refrigerant leakage) ■ Defective electronic expansion valve ■ Refrigerant drift in the outdoor heat exchanger ■ Poor compression performance of compressor 																									

Troubleshooting



Check No.01
Refer to P.183



Check No.12
Refer to P.185



Caution Be sure to turn off the power switch before connecting or disconnecting connectors, or parts may be damaged.

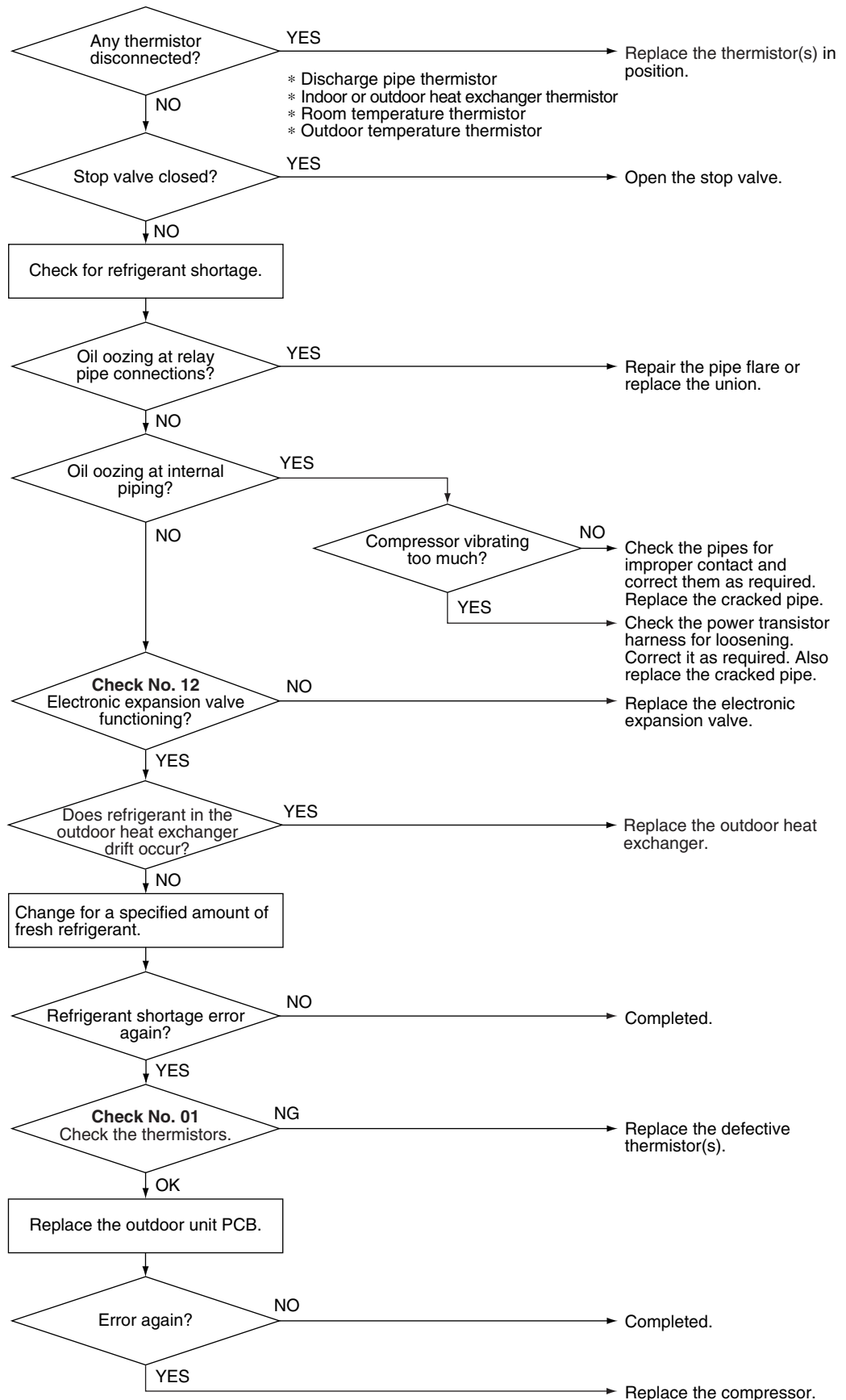

(R19373)

2.35 Low-voltage Detection or Over-voltage Detection

Error Code	U2
Method of Error Detection	<p>★ Indoor Unit</p> <p>The zero-cross detection of the power supply is evaluated by the indoor unit PCB.</p> <p>★ Outdoor Unit</p> <p>Low-voltage detection: An abnormal voltage drop is detected by the DC voltage detection circuit.</p> <p>Over-voltage detection: An abnormal voltage rise is detected by the over-voltage detection circuit.</p>
Error Decision Conditions	<p>★ Indoor Unit</p> <p>There is no zero-cross detection in approximately 10 seconds.</p> <p>★ Outdoor Unit</p> <p>Low-voltage detection:</p> <ul style="list-style-type: none"> ■ The voltage detected by the DC voltage detection circuit is below 150 ~ 180 V (depending on the model). ■ The compressor stops if the error occurs, and restarts automatically after 3-minute standby. <p>Over-voltage detection:</p> <ul style="list-style-type: none"> ■ An over-voltage signal is fed from the over-voltage detection circuit to the microcomputer. ■ The compressor stops if the error occurs, and restarts automatically after 3-minute standby.
Supposed Causes	<ul style="list-style-type: none"> ■ Power supply voltage is not as specified. ■ Defective DC voltage detection circuit ■ Defective over-voltage detection circuit ■ Defective PAM control part ■ Disconnection of compressor harness ■ Short circuit inside the fan motor winding ■ Noise ■ Momentary drop of voltage ■ Momentary power failure ■ Defective outdoor unit PCB ■ Defective indoor unit PCB

Troubleshooting

**Caution**

Be sure to turn off the power switch before connecting or disconnecting connectors, or parts may be damaged.

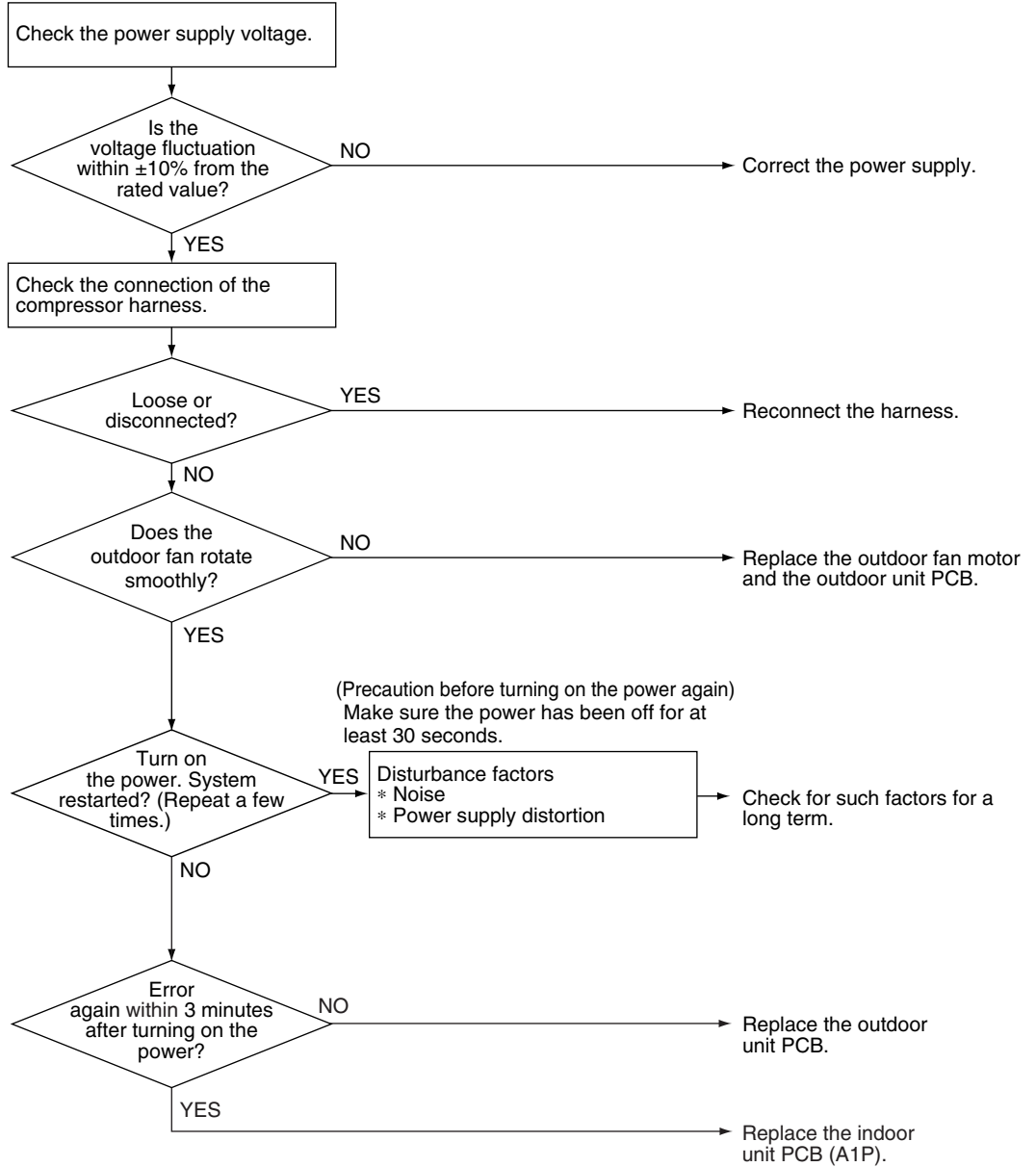

(R19955)

2.36 Signal Transmission Error (Between Indoor Unit and Outdoor Unit)

Error Code	U4
Method of Error Detection	The data sent from the outdoor unit is checked for problem.
Error Decision Conditions	The data sent from the outdoor unit cannot be received without error, or the disable status of signal transmission continues for 15 seconds.
Supposed Causes	<ul style="list-style-type: none">■ Wiring error■ Breaking of the connecting wires between the indoor unit and the outdoor unit■ Improper insulation of the connecting wires and earth■ Wiring length exceeds the specified range■ Defective outdoor unit PCB■ Defective indoor unit PCB■ Layer short inside the fan motor winding

Troubleshooting

Check No.11
Refer to P.185

Caution Be sure to turn off the power switch before connecting or disconnecting connectors, or parts may be damaged.

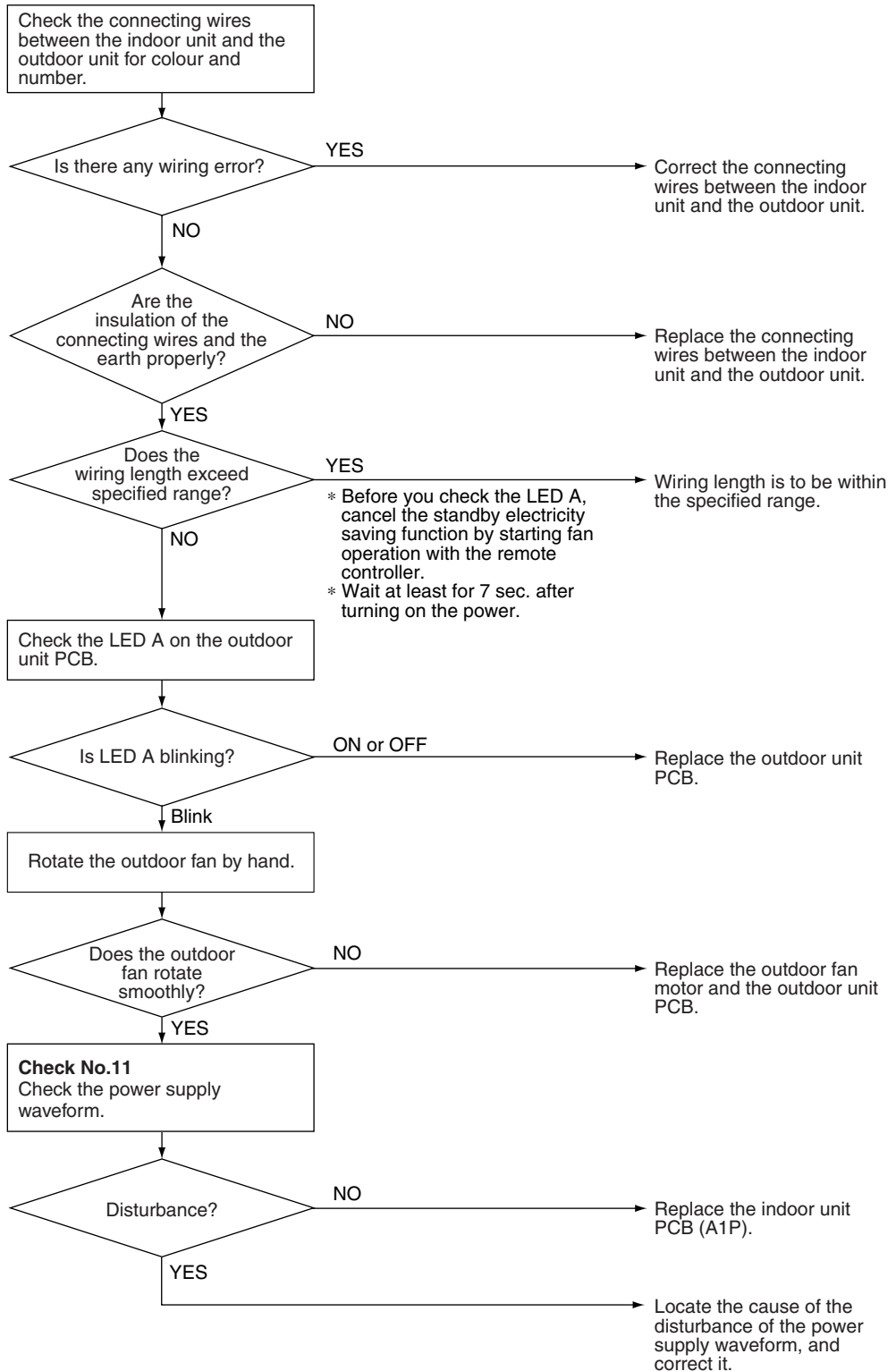

(R19684)

2.37 Outdoor Unit PCB Abnormality or Communication Circuit Abnormality

Error Code	U4
Method of Error Detection	Detection within the programme of the microcomputer
Error Decision Conditions	<ul style="list-style-type: none">■ The programme of the microcomputer does not work in order.■ Indoor-outdoor unit signal transmission cannot be performed for more than 15 seconds.
Supposed Causes	<ul style="list-style-type: none">■ Power supply voltage is not as specified.■ Improper earth work■ Defective varistor or fuse on the outdoor unit PCB■ Defective thermal fuse on the terminal board of the outdoor unit■ Disconnection of connecting wires■ Defective outdoor unit PCB■ Noise■ Disturbed power supply waveform■ Wrong wiring■ Improper insulation of the connecting wires and earth■ Defective indoor unit PCB

Troubleshooting

**Caution**

Be sure to turn off the power switch before connecting or disconnecting connectors, or parts may be damaged.

Check indoor unit also, because a communication circuit fault may be caused by the problem related to the indoor unit.

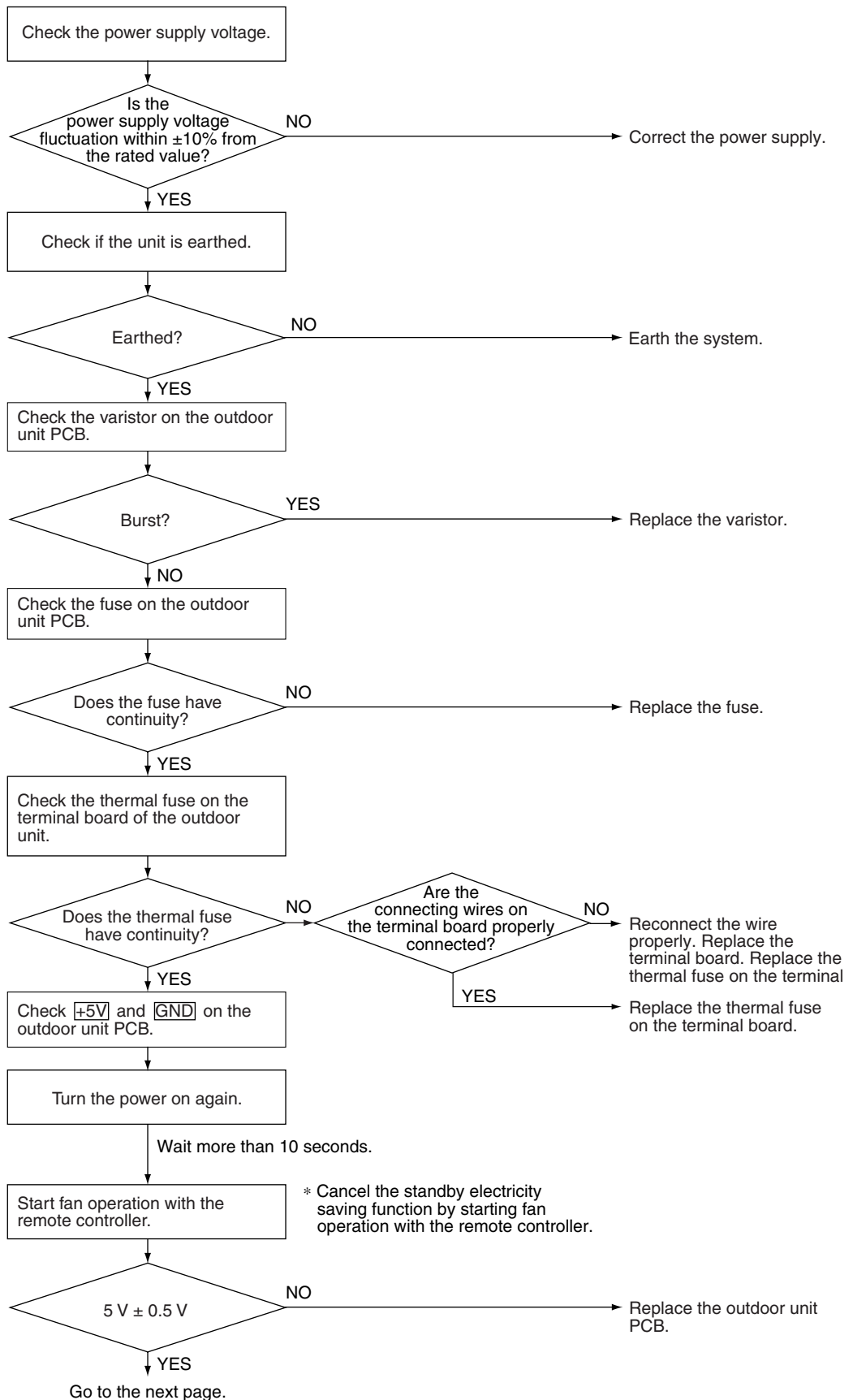

(R19686)

Check No.11
Refer to P.185

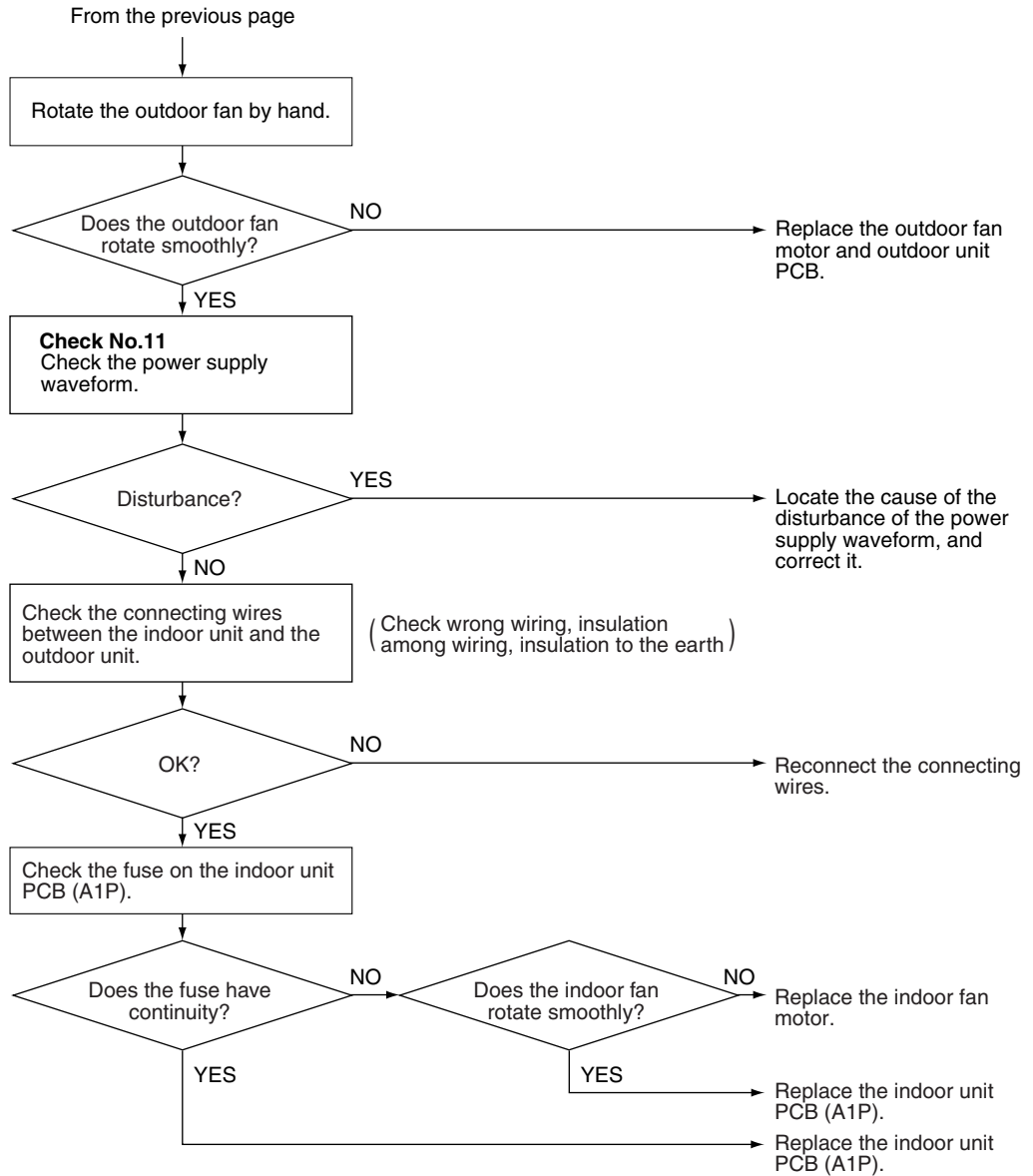

(R19687)

2.38 Signal Transmission Error on Microcomputer for Humidifying

Error Code

U7

Method of Error Detection

Communication error between microcomputers mounted on the outdoor unit PCB.

Error Decision Conditions

- The data sent from the microcomputer for humidifying can not be received for 10 seconds.
- Zero-cross signal on the microcomputer for humidifying cannot be detected.
- Error counter is reset when the data from the microcomputer for humidifying can be successfully received.

Supposed Causes

- Defective outdoor unit PCB
- Noise

Troubleshooting



Caution

Be sure to turn off the power switch before connecting or disconnecting connectors, or parts may be damaged.

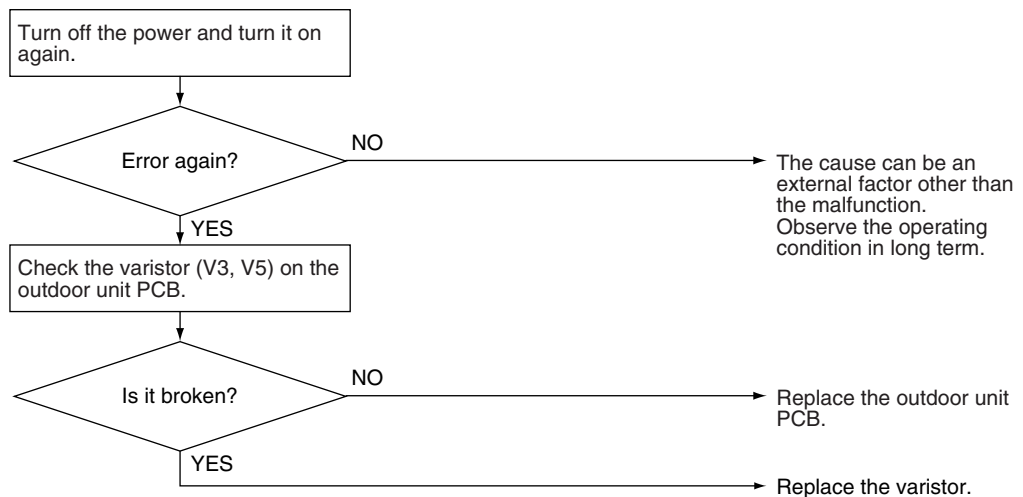

(R19732)

2.39 Unspecified Voltage (Between Indoor Unit and Outdoor Unit)

Error Code

UA

Method of Error Detection

Check the incompatible power supply between indoor unit and outdoor unit by using signal transmission.

Error Decision Condition

In case that the indoor unit model is not compatible with outdoor unit model.

Supposed Causes

- Wrong models interconnected
- Wrong wiring of connecting wires
- Wrong indoor unit PCB or outdoor unit PCB mounted
- Defective indoor unit PCB
- Defective outdoor unit PCB

Troubleshooting



Caution

Be sure to turn off the power switch before connecting or disconnecting connectors, or parts may be damaged.

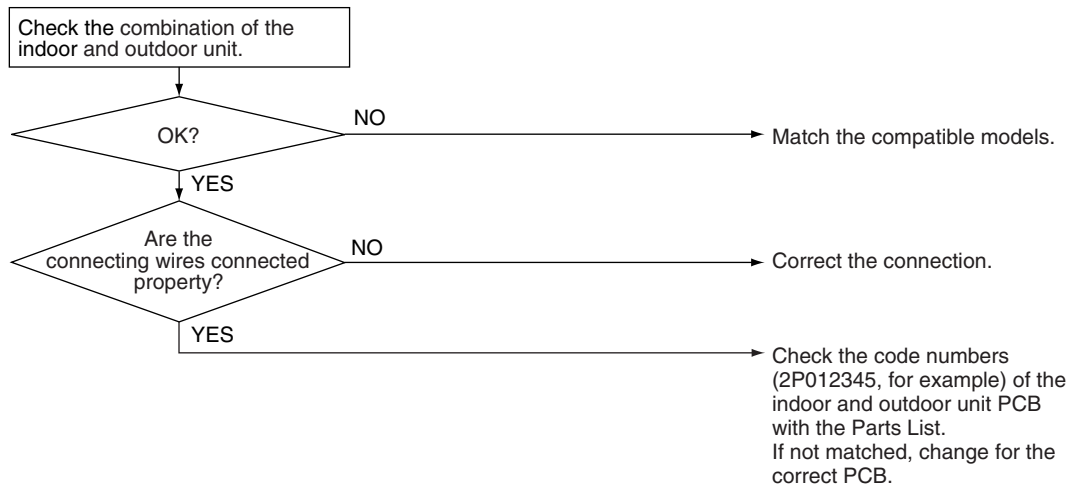

(R19506)

2.40 Improper Power Supply Wiring

Error Code	UA
Method of Error Detection	Check for the incompatible power supply of DC part by using the DC voltage detection circuit.
Error Decision Condition	<ul style="list-style-type: none"> ■ The voltage detected by the DC voltage detection circuit is 350 V and more or 180 V and less for more than 1 second. ■ If the error repeats, the system is shut down. ■ Reset condition: Continuous run for about 20 minutes without any other error
Supposed Causes	<ul style="list-style-type: none"> ■ Power supply voltage is not as specified. ■ Malfunction of DC voltage detection circuit

Troubleshooting

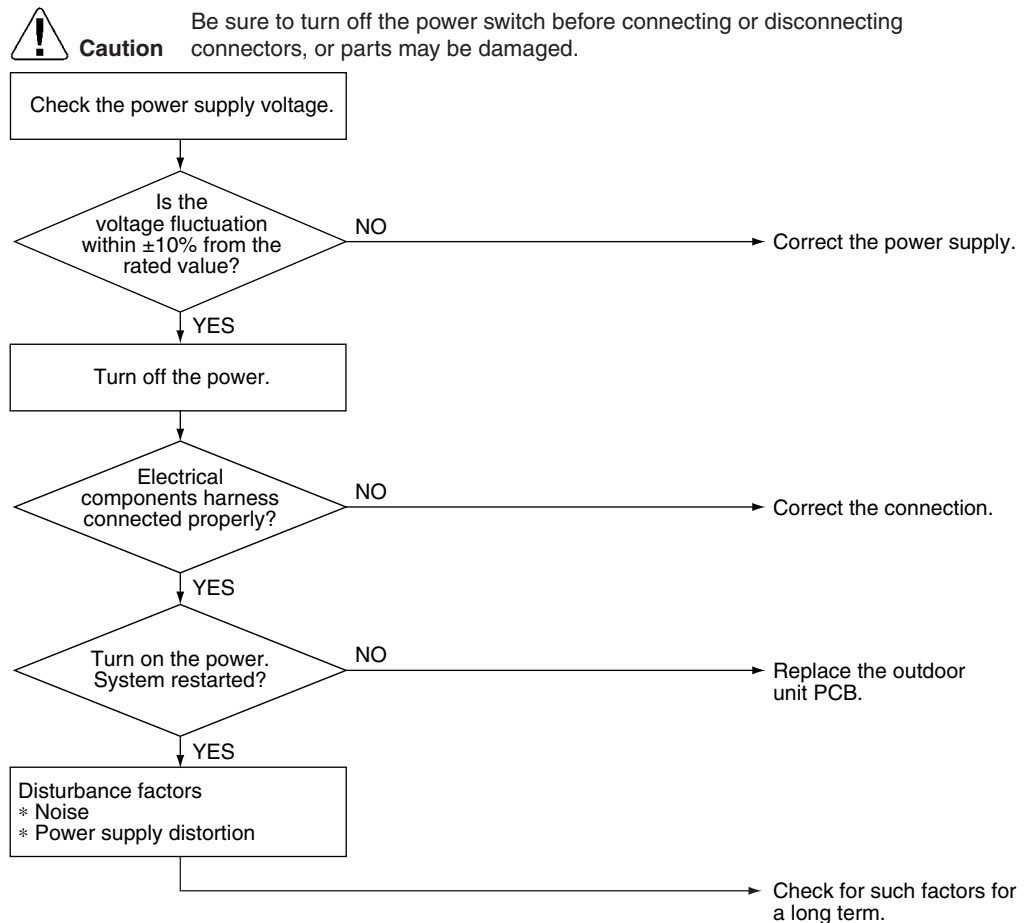

(R20444)

2.41 Incomplete Setting for Hose Length

Error Code	UA
Method of Error Detection	This fault occurs when the humidification hose length is not stored in the EEPROMs of the indoor unit and the outdoor unit. (Hose length is not stored at initial power on.)
Error Decision Conditions	When the humidification hose length is not stored in EEPROMs of the indoor unit and the outdoor unit.
Supposed Causes	<ul style="list-style-type: none"> ■ Hose length is not set. ■ Hose length is erased by replacement of the indoor unit PCB and the outdoor unit PCB. (When both the indoor unit PCB and the outdoor unit PCB are replaced simultaneously, the set value is erased.)

Troubleshooting

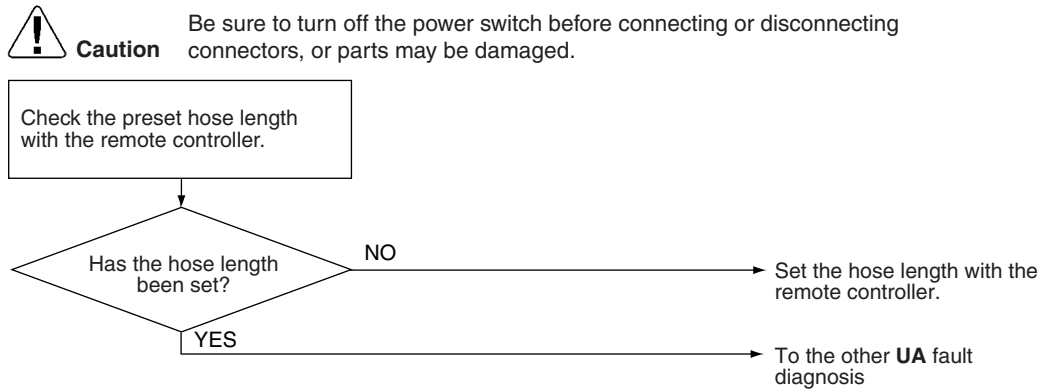

(R19685)

How to check the preset hose length

- (1) Open the cover of the remote controller.
- (2) Press the **SET UP** button for 5 seconds.
- (3) Press the **▲** or **▼** button and select **Hose length**.
- (4) Press the **APPLY** button pointing the transmitter of the remote controller at the indoor unit.
- (5) The display shows the preset hose length.



Note:

- When the hose length is not set, **Hose Unset** is displayed.
Referring to Humidifying Hose Length Setting on Part 7, set the hose length.
- To return to the normal mode,
 - * press the **SET UP** button for 5 seconds.
 - * close the cover of the remote controller.
 - * leave the remote controller for 60 seconds.

2.42 Lights-out of Microcomputer Status Lamp

Error Code	No display
Method of Error Detection	When a microcomputer fault is detected, LED A turns off.
Error Decision Conditions	
Supposed Causes	<ul style="list-style-type: none"> ■ Outdoor unit PCB is not power supplied. ■ Power supply failure due to noise

Troubleshooting

Caution

Be sure to turn off the power switch before connecting or disconnecting connectors, or parts may be damaged.

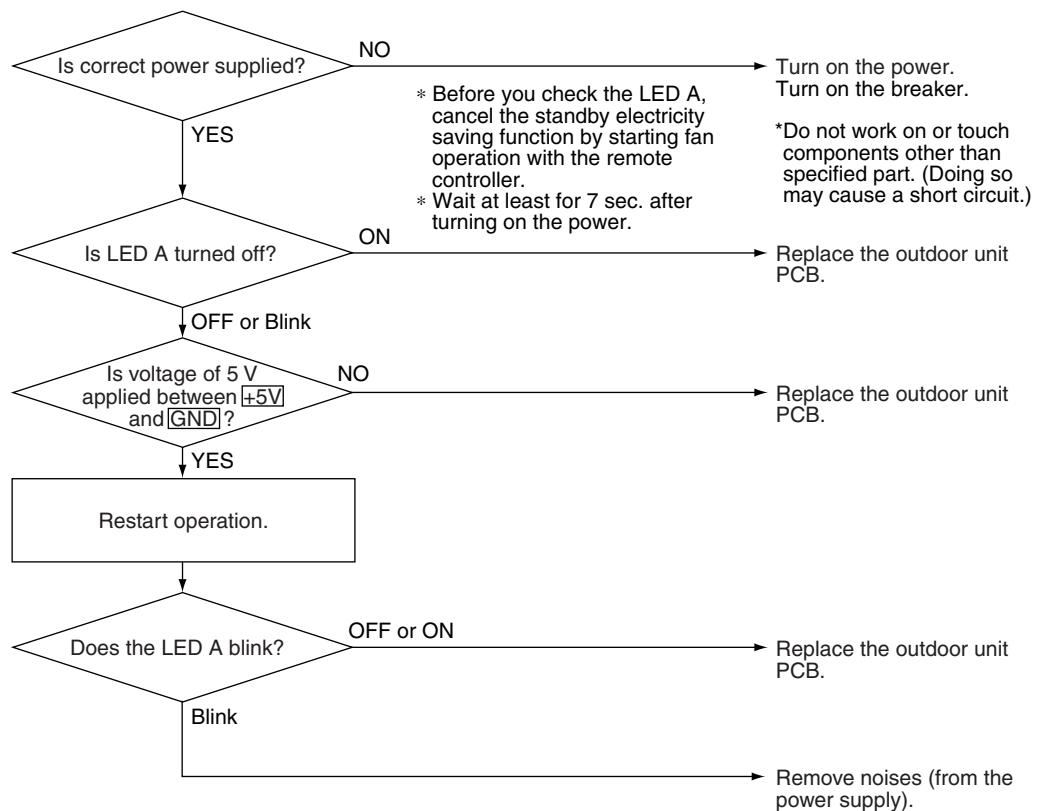

(R19691)

3. Check

3.1 Thermistor Resistance Check

Check No.01

Disconnect the connectors of the thermistors from the PCB, and measure the resistance of each thermistor using a multimeter.

The data is for reference purpose only.

Thermistor temperature (°C)	Resistance (kΩ)
-20	197.8
-15	148.2
-10	112.1
-5	85.60
0	65.93
5	51.14
10	39.99
15	31.52
20	25.02
25	20.00
30	16.10
35	13.04
40	10.62
45	8.707
50	7.176

(R25°C = 20 kΩ, B = 3950 K)

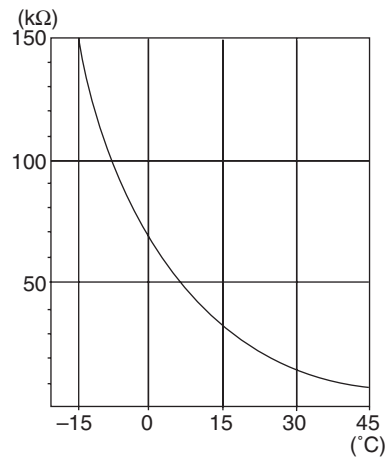

(R11905)

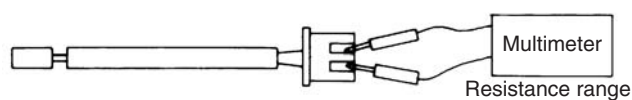

(R19733)

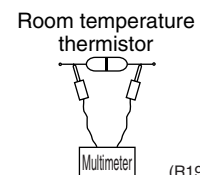

(R19559)

- When the room temperature thermistor is soldered on a PCB, remove the PCB from the control PCB to measure the resistance.
- When the connector of indoor heat exchanger thermistor is soldered on a PCB, remove the thermistor and measure the resistance.

3.2 Fan Motor Connector Output Check

Check No.02

1. Check the connection of connector.
2. Turn off the power.
3. Check if the resistances between the phases U - V (pins 1 - 7) and between the phases V - W (pins 7 - 4) are 45 ~ 65 Ω respectively.

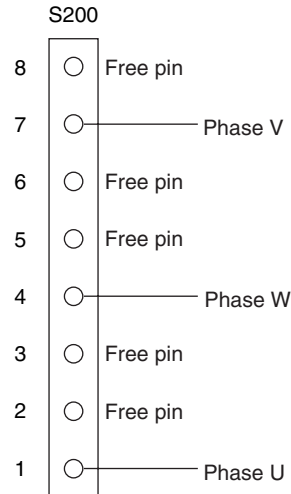

(R19733)

3.3 Humidity Sensor Check

Check No.07

1. Check the connection of connector.
 2. Check the input from the humidity sensor (*1).
 3. Change the ambient conditions (*2) and check that the input level changes accordingly.
- *1 The voltage value may differ depending on the sensors.
 *2 Change the humidity, temperature, airflow rate. To do this, merely breathe upon.

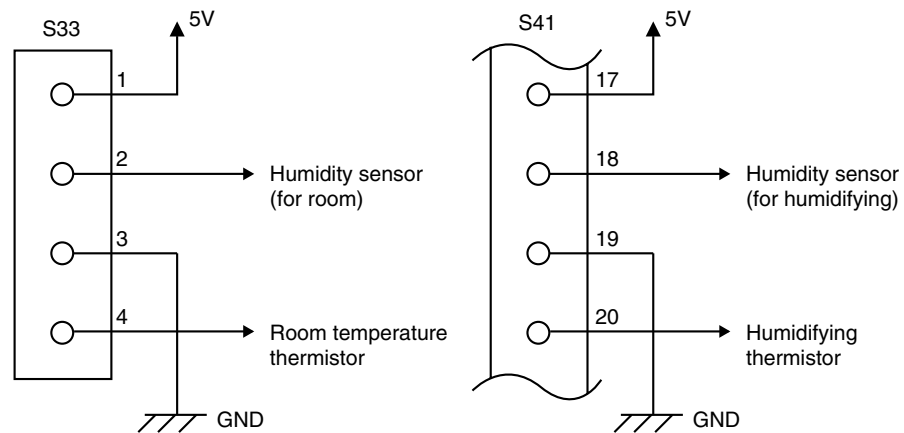

(R19734)

3.4 Power Supply Waveforms Check

Check No.11

Measure the power supply waveform between No. 1 and No. 2 on the terminal board, and check the waveform disturbance.

- Check if the power supply waveform is a sine wave. (Fig.1)
- Check if there is waveform disturbance near the zero cross. (sections circled in Fig.2)

Fig.1

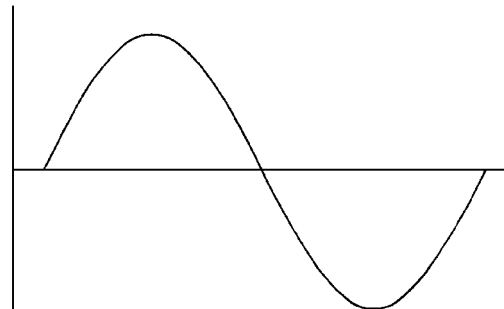

(R1736)

Fig.2

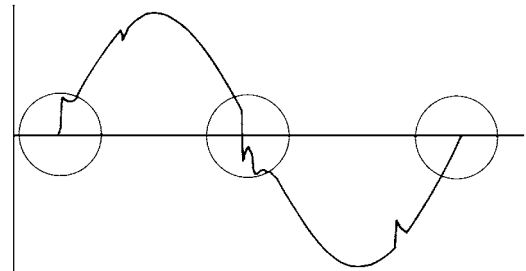

(R1444)

3.5 Electronic Expansion Valve Check

Check No.12

Conduct the followings to check the electronic expansion valve (EV).

1. Check if the EV connector is correctly connected to the PCB.
2. Turn the power off and on again, and check if the EV generates a latching sound.
3. If the EV does not generate a latching sound in the above step 2, disconnect the connector and check the continuity using a multimeter.
4. Check the continuity between the pins 1 - 6, 2 - 6, 3 - 6, 4 - 6. If there is no continuity between the pins, the EV coil is faulty.
5. If the continuity is confirmed in step 3, the outdoor unit PCB is faulty.

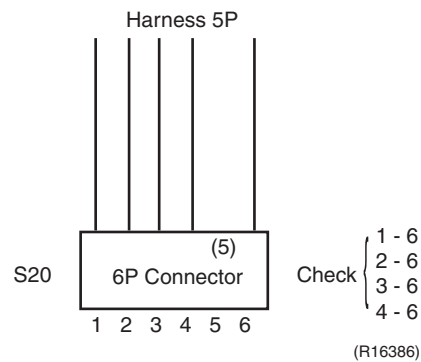

3.6 Four Way Valve Performance Check

Check No.13

< Caution on resetting the power supply >

* Be sure to wait for 30 sec. or more after turning off the power.

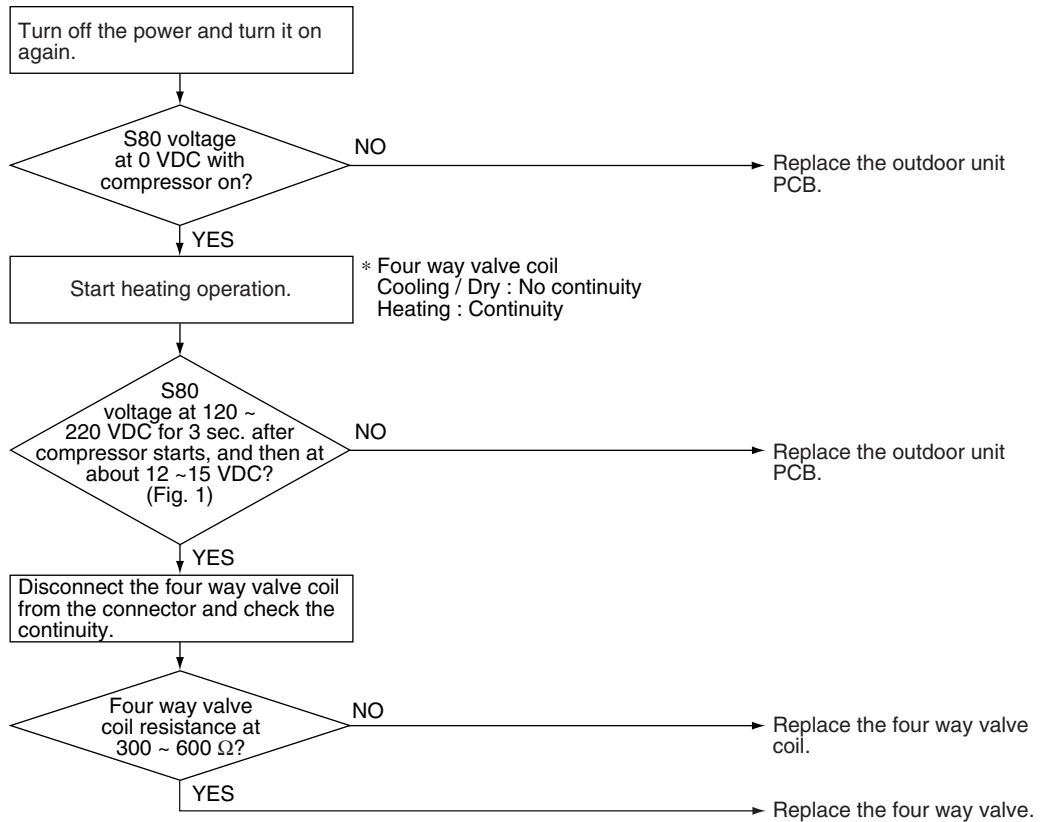

(Fig. 1)

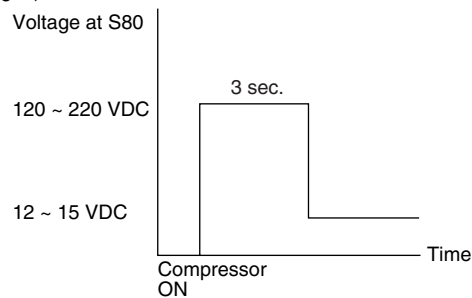

(R13938)

3.7 Inverter Unit Refrigerant System Check

Check No.14

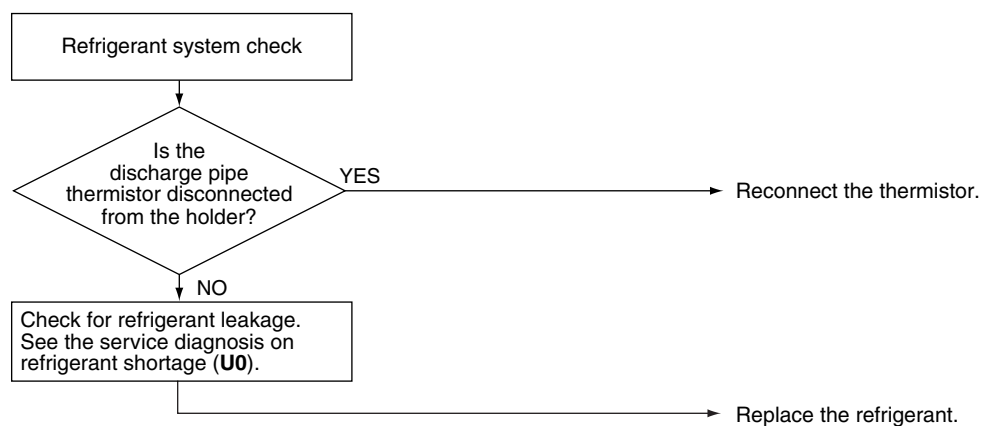

(R15833)

3.8 Inverter Analyser Check

Check No.15

■ Characteristics

Inverter analyser: RSUK0917C

If an abnormal stop occurs due to compressor startup failure or overcurrent output when using an inverter unit, it is difficult to judge whether the stop is caused by the compressor failure or some other failure (main PCB, power module, etc.). The inverter analyser makes it possible to judge the cause of trouble easily and securely. (Connect an inverter analyser as a quasi-compressor instead of compressor and check the output of the inverter)

■ Operation Method

Step 1

Be sure to turn the power off.

Step 2

Install an inverter analyser instead of a compressor.

Note:

Make sure the charged voltage of the built-in smoothing electrolytic capacitor drops to 10 VDC or below before carrying out the service work.

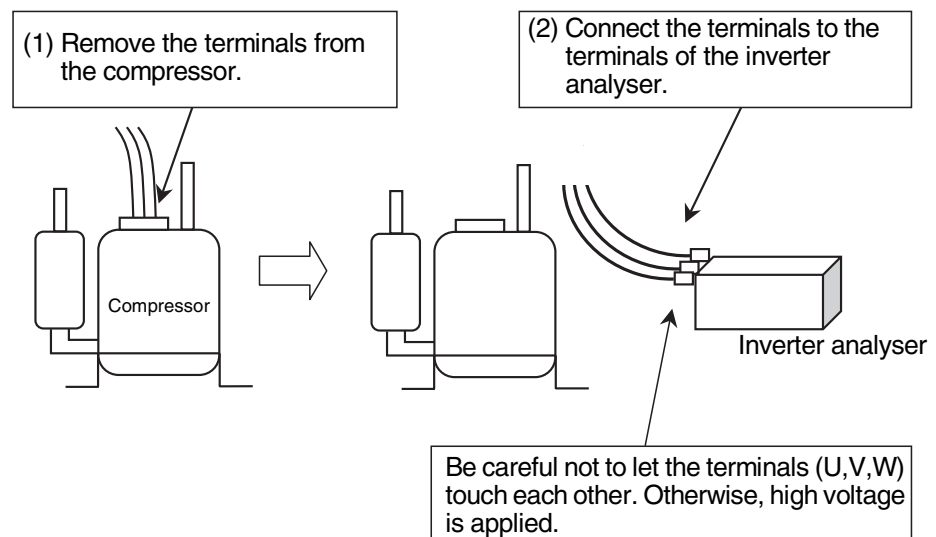

Reference:

If the terminals of the compressor are not FASTON terminals (difficult to remove the wire on the terminals), it is possible to connect wires available on site to the outdoor unit from output side of PCB. (Do not connect them to the compressor at the same time, otherwise it may result in incorrect detection.)

Step 3

Activate power transistor test operation from indoor unit.

- (1) Turn the power on.
- (2) Open the cover of the remote controller.
- (3) Press the **SET UP** button for 5 seconds.
- (4) Press the **▼** or **▲** button and select **Test mode**.
- (5) Press the **APPLY** button.
→ 7° is displayed.
- (6) Press the **FAN ONLY** button.
→ Power transistor test operation starts.

(2) Open the cover.

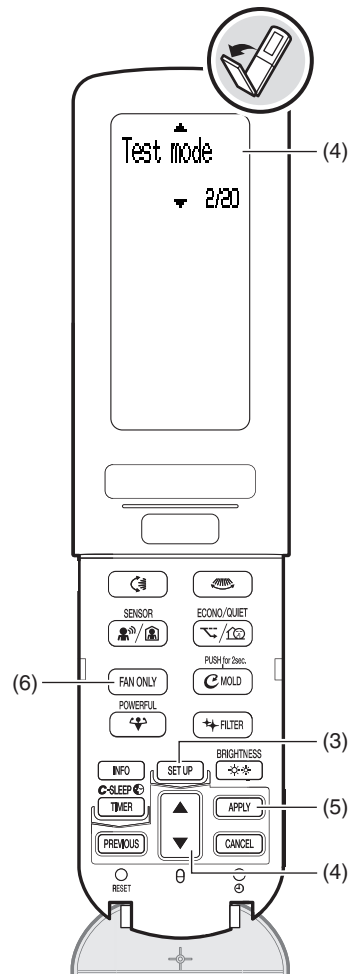

(R20203)

■ Diagnose method (Diagnose according to 6 LEDs lighting status.)

- (1) If all the LEDs are lit uniformly, the compressor is defective.
→ Replace the compressor.
- (2) If the LEDs are not lit uniformly, check the power module.
→ Refer to **Check No.22**.
- (3) If NG in **Check No.22**, replace the power module.
(Replace the PCB. The power module is united with the PCB.)
If OK in **Check No.22**, check if there is any solder cracking on the PCB.
- (4) If any solder cracking is found, replace the PCB or repair the soldered section.
If there is no solder cracking, replace the PCB.



Caution

- (1) When the output frequency is low, the LEDs blink slowly. As the output frequency increases, the LEDs blink quicker. (The LEDs look like they are lit.)
- (2) On completion of the inverter analyser diagnosis, be sure to re-crimp the FASTON terminals. Otherwise, the terminals may be burned due to loosening.

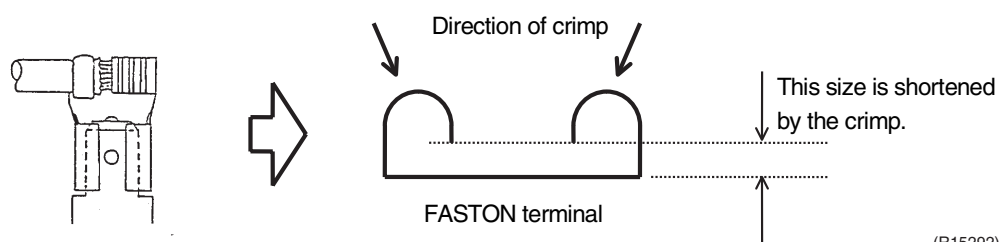

(R15292)

3.9 Rotating Pulse Check on Outdoor Unit PCB

Check No.16

Outdoor fan motor: S70

Humidifier fan motor: S72

Make sure that the voltage of 320 ± 30 V is applied.

1. Set operation off and power off. Disconnect the connector S70 or S72.
2. Check that the voltage between the pins 4 - 7 (S70) or the pins 5 - 8 (S72) is 320 VDC.
3. Check that the control voltage between the pins 3 - 4 (S70) or the pins 4 - 5 (S72) is 15 VDC.
4. Check that the rotation command voltage between the pins 2 - 4 (S70) or the pins 3 - 5 (S72) is 0 ~ 6.5 VDC.
5. Keep operation off and power off. Connect the connector S70 or S72.
6. Check whether 4 pulses (0 ~ 15 V) are output at the pins 1 - 4 (S70) or the pins 2 - 5 (S72) when the fan motor is rotated 1 turn by hand.

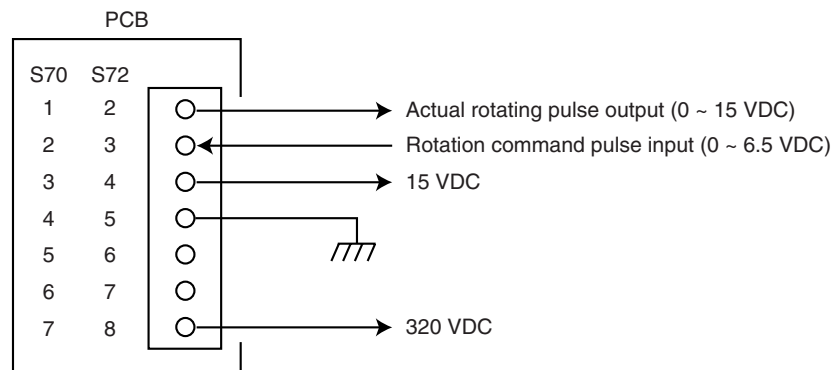

(R19735)

- | | |
|-------------------------------------|--|
| If NG in step 2 → Defective PCB | → Replace the outdoor unit PCB. |
| If NG in step 4 → Defective Hall IC | → Replace the corresponding fan motor. |
| If OK in both steps 2 and 4 | → Replace the outdoor unit PCB. |

3.10 Installation Condition Check

Check No.17

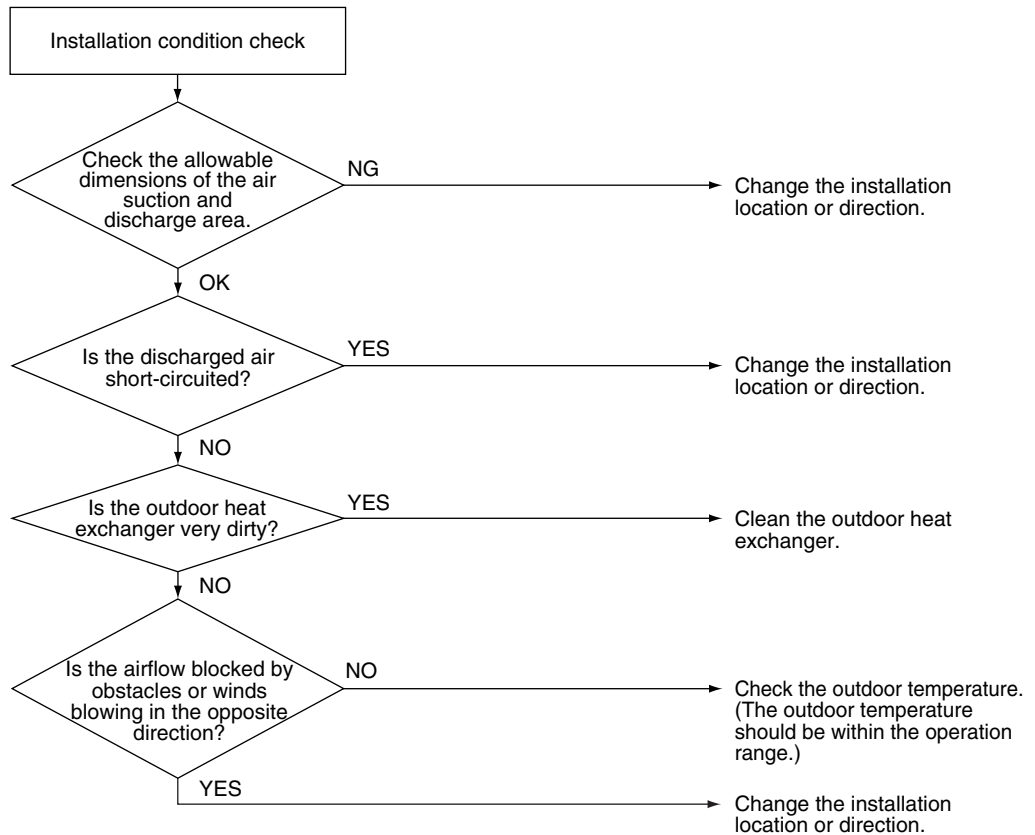

(R19394)

3.11 Discharge Pressure Check

Check No.18

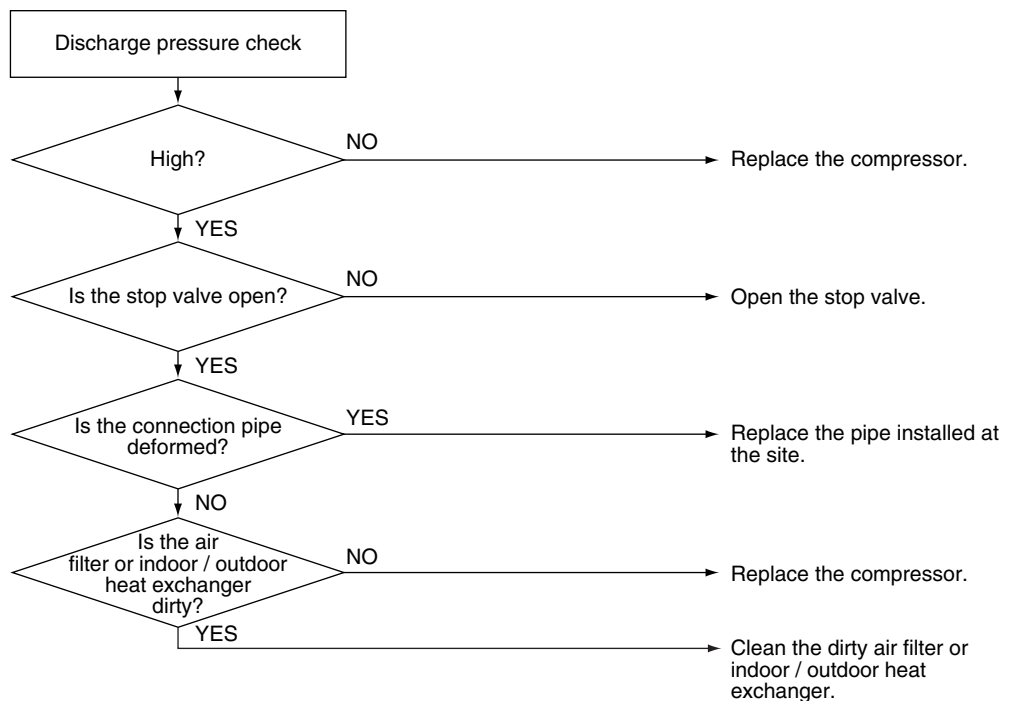

(R19385)

3.12 Outdoor Fan System Check

Check No.19

DC motor

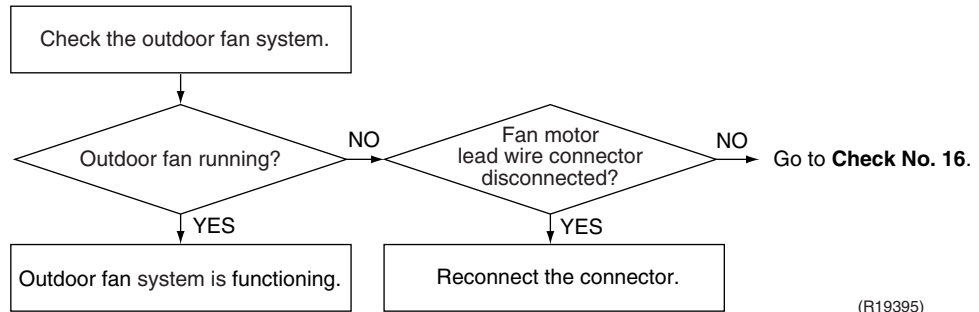

(R19395)

3.13 Main Circuit Short Check

Check No.20



Note: Check to make sure that the voltage between (+) and (-) of the diode bridge (DB1) is approximately 0 V before checking.

- Measure the resistance between the pins of the DB1 referring to the table below.
- If the resistance is ∞ or less than 1 kW, short circuit occurs on the main circuit.

Negative (-) terminal of multimeter (positive terminal (+) for digital multimeter)	~ (2, 3)	+ (4)	~ (2, 3)	- (1)
Positive (+) terminal of multimeter (negative terminal (-) for digital multimeter)	+ (4)	~ (2, 3)	- (1)	~ (2, 3)
Resistance is OK.	several k Ω ~ several M Ω	∞	∞	several k Ω ~ several M Ω
Resistance is NG.	0 Ω or ∞	0	0	0 Ω or ∞

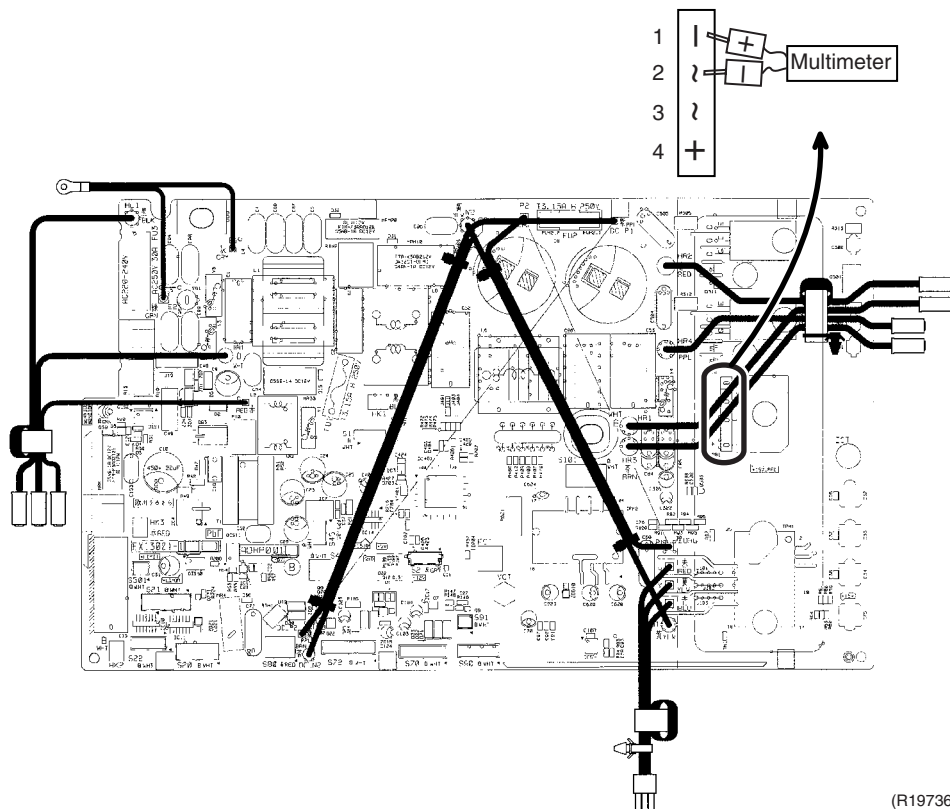

(R19736)

3.14 Power Module Check

Check No.22



Note: Check to make sure that the voltage between (+) and (-) of the diode bridge (DB1) is approximately 0 V before checking.

- Disconnect the compressor harness connector from the outdoor unit PCB. To disengage the connector, press the protrusion on the connector.
- Follow the procedure below to measure resistance between the (+) or (-) terminal of the diode bridge, and the U, V, or W terminal of the compressor with a multimeter. Evaluate the measurement results referring to the following table.

Negative (-) terminal of multimeter (positive terminal (+) for digital multimeter)	Diode bridge (+)	UVW	Diode bridge (-)	UVW
Positive (+) terminal of multimeter (negative terminal (-) for digital multimeter)	UVW	Diode bridge (+)	UVW	Diode bridge (-)
Resistance is OK.	several k Ω ~ several M Ω			
Resistance is NG.	0 Ω or ∞			

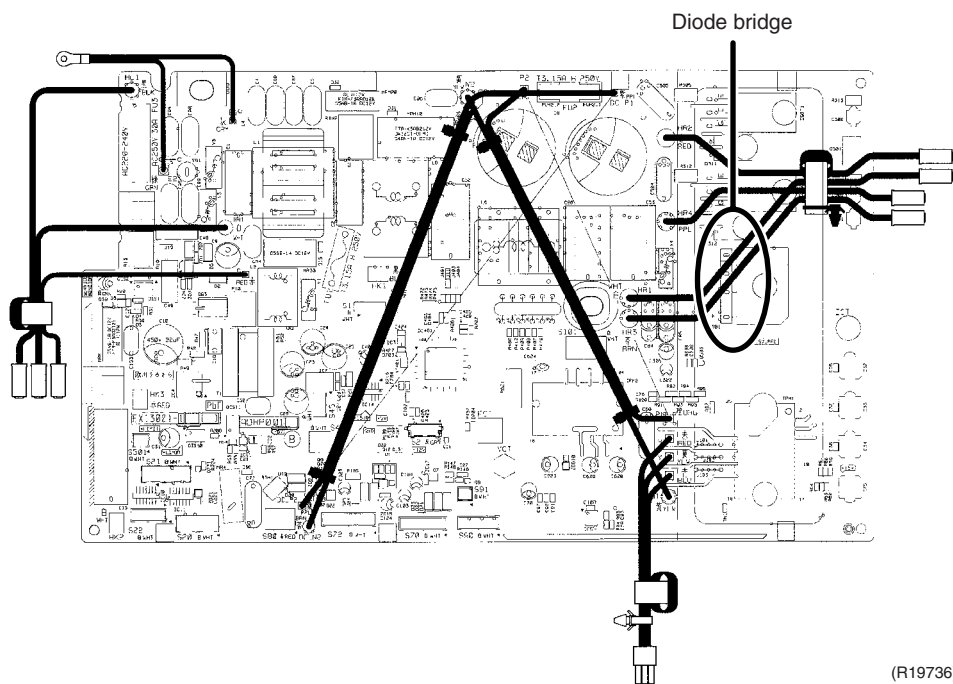

Part 7

Tips for Servicing

1. Tips for Servicing	194
1.1 Pump Down Operation	194
1.2 Forced Cooling Operation	194
2. Trial Operation	195
3. Field Settings	196
3.1 SET UP Menu	196
3.2 Service Setting Menu	196
3.3 Humidifying Hose Length Setting	199
4. Silicone Grease on Power Transistor / Diode Bridge	200

1. Tips for Servicing

1.1 Pump Down Operation

Outline

In order to protect the environment, be sure to conduct pump down operation when relocating or disposing the unit.

Detail

- 1) Remove the valve caps from the liquid stop valve and the gas stop valve.
- 2) Carry out forced cooling operation.
- 3) After 5 to 10 minutes, close the liquid stop valve with a hexagonal wrench.
- 4) After 2 to 3 minutes, close the gas stop valve and stop the forced cooling operation.
- 5) After the operation, reattach the valve caps.

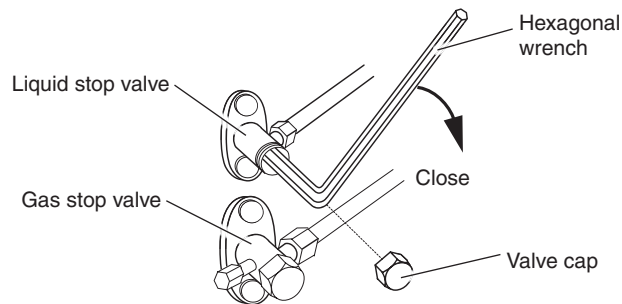

(R19737)



Refer to forced cooling operation below.

1.2 Forced Cooling Operation

Item	Forced Cooling
Conditions	The forced cooling operation is allowed when both the following conditions are met. <ol style="list-style-type: none"> 1) The outdoor unit is not abnormal and not in the 3-minute standby mode. 2) The outdoor unit is not operating.
Start	Press the forced cooling operation ON/OFF button (SW1) on the indoor unit for 5 seconds.
Command frequency	30 Hz
End	The forced cooling operation ends when any of the following conditions is fulfilled. <ol style="list-style-type: none"> 1) The operation ends automatically after 15 minutes. 2) Press the forced cooling operation ON/OFF button (SW1) on the indoor unit again. 3) Press the ON/OFF button on the remote controller.
Others	The protection functions are prior to all others in the forced cooling operation.

Indoor Unit

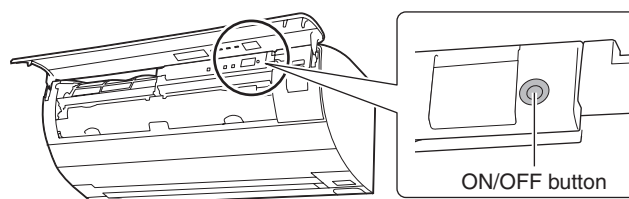

(R19738)

2. Trial Operation

Outline

Carry out the trial operation in accordance with the operation manual to ensure that all functions and parts, such as flap movement, are working properly.

Trial operation should be carried out in either cooling or heating operation.

Detail

1. Measure the power supply voltage and make sure that it falls within the specified range.
2. In cooling operation, select the lowest programmable temperature (18°C); in heating operation, select the highest programmable temperature (30°C).
 - ♦ Trial operation may be disabled in either operation mode depending on the room temperature.
 - ♦ After trial operation is complete, set the temperature to a normal level (26°C ~ 28°C in cooling, 20°C ~ 24°C in heating operation).
 - ♦ For protection, the system does not start for 3 minutes after it is turned off.

- (1) Open the cover of the remote controller.
- (2) Press the **SET UP** button for 5 seconds.
- (3) Press the **▼** or **▲** button and select **Test mode**.
- (4) Press the **APPLY** button.
- (5) 7° 0 is displayed.
- (6) Close the cover of the remote controller and press the **COOL**, **HEAT** or **HUMIDIFY** button to start trial operation.
- (7) Trial operation terminates in approximately 30 minutes and switches into normal mode. To quit trial operation, press the **OFF** button.

(1) Open the cover.

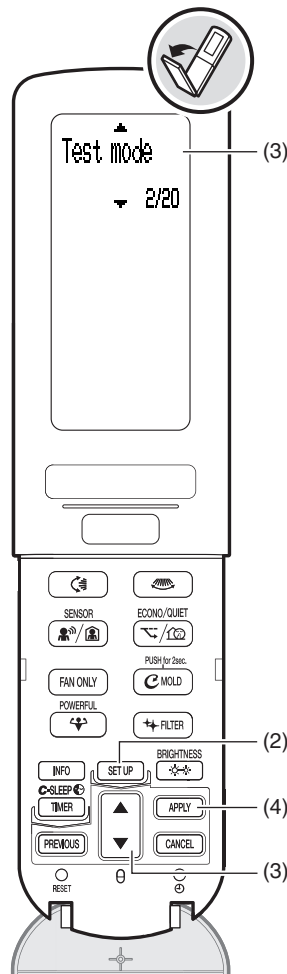

(R19739)

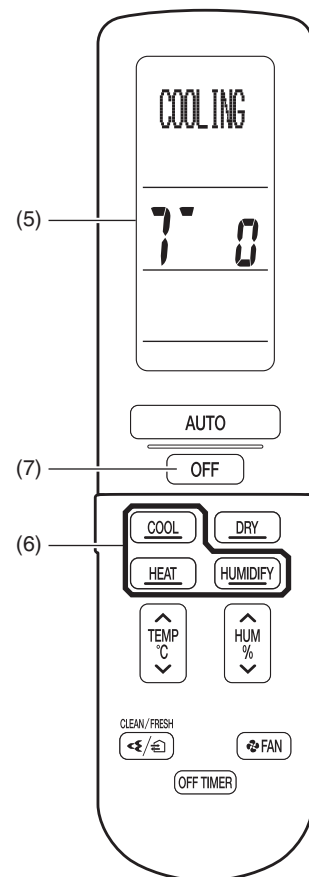

(R19740)

3. Field Settings

3.1 SET UP Menu

You can change the default settings according to your room's environment.

No.	Menu items
1	INTELLIG.EYE AIRFLOW
2	AUTO OFF time
3	BREEZE AIRFLOW
4	HUMIDIFY AIRFLOW
5	CONTINUE DRY
6	INSTALLED POSITION
7	RESET USED POWER
8	SOUND VOLUME
9	CONTRAST
10	24 HOUR FRESH AIR
11	RC ADDRESS
12	CHILD LOCK

* Refer to the operation manual for details.

3.2 Service Setting Menu

Press the **SET UP** button for 5 seconds to enter the field setting menu.

Page	Menu	Item				
1	Checking error code	-	-	-	-	-
2	Test mode	-	-	-	-	-
3	Hose length	~ 3M	3.1M ~ 4M	4.1M ~ 6M	6.1M ~ 8M	8.1M ~ 10M
4	Hose drying	-	-	-	-	-
5	RC demo	-	-	-	-	-
6	AC demo	-	-	-	-	-
7	Defrost QUICK HEAT	On	Off	-	-	-
8	Circulate setting	Std	Low	Off	-	-
9	Shutter setting	On	Off	-	-	-
10	MOLD PROOF STREAMER	On	Off	-	-	-
11	Adjust cool Temp.	Std	+1	+2	-1	-2
12	Adjust heat Temp.	Std	+1	+2	-1	-2
13	Humidify unit	On	Off	-	-	-
14	Thermo off setting	Low	Keep	-	-	-
15	Control priority	Wireless	Wired	-	-	-
16	Standby saving	On	Off	-	-	-
17	Preheating	On	Off	-	-	-
18	Auto restart	On	Off	-	-	-
19	Auto clean speed	Std	Fast	-	-	-
20	RESET setting	-	-	-	-	-

1. Checking error code
It displays the error code. An unconfirmed error code can also be displayed, unlike long pressing the **CANCEL** button.
2. Test mode
It forces to turn on the thermostat and conducts test operation according to the remote controller setting except for temperature and humidity.
Test operation will finish automatically in about 30 minutes.

3. Hose length
It sets the length of the humidifying hose.
The longer the length setting is, the higher the humidifying fan rotation frequency becomes.
4. Hose drying
It forces to turn on the humidifying fan and dries the inside of the humidifying hose.
Forced hose drying operation lasts about 30 minutes.
5. RC demo
It shows a sample of the remote controller display. (Ex. information by pressing **INFO** button)
6. AC demo
It starts demonstrational operation of the air conditioner.
7. Defrost QUICK HEAT
It sets defrost operation on/off while the QUICK HEATING TIMER is set. When it is set to **OFF**, the unit does not carry out defrost operation.
8. Circulate setting
When **INSTALLED POSITION** is set to oblong, if the **Circulate setting** is set to **Low**, the angle of horizontal flaps in circulation airflow becomes same as in case of **INSTALLED POSITION** is set to horizontal. (The horizontal flaps are set facing a little higher.)
If **Circulate setting** is set to **OFF**, the angle of horizontal flaps in circulation airflow becomes same as in case of comfort airflow in cooling operation.
9. Shutter setting
It sets the air inlet shutter for on/off. If it is set to off, there will be no bottom air intake.
10. MOLD PROOF STREAMER
It sets the streamer on/off during MOLD PROOF operation. If it is set to off, the streamer will not be used.
11. Adjust cool Temp.
It sets the amount of room temperature adjustment in cooling operation.
12. Adjust heat Temp.
It sets the amount of room temperature adjustment in heating operation.
13. Humidify unit
It turns on/off humidifying operation.
14. Thermo off setting
It sets the airflow rate when the thermostat is off in cooling operation.
If it is set to **Keep**, the fan keeps rotating at the set airflow rate.
15. Control priority
Do not change the default setting (**Wireless**).
16. Standby saving
It turns on/off the standby electricity saving function.
17. Preheating
It turns on/off the preheating control.
18. Auto restart
It turns on/off the auto-restart function.

19. Auto clean speed

It sets the operation time for cleaning filter.

If it is set to **Fast**, the cleaning time is about 7 minutes.

20. RESET setting

It resets the SET UP menu and service setting menu to factory setting.



Note

Note for replacing the indoor unit PCB

When the indoor unit PCB is replaced, all the settings are reset and have to be set on the remote controller again because the remote controller does not resend the recorded settings to the indoor unit.

However when only the remote controller is replaced, you do not have to redo each setting because the indoor unit maintains the settings.

3.3 Humidifying Hose Length Setting

Outline

Set the humidifying hose length with the remote controller to ensure humidifying capacity. Power on the indoor unit to establish the communication between the indoor unit and the remote controller. (The humidifying hose length includes the rear part of the indoor unit.)

Detail

- (1) Open the cover of the remote controller.
- (2) Press the **SET UP** button for 5 seconds.
- (3) Press the **▲** or **▼** button and select **Hose length**.
- (4) Press the **APPLY** button.
- (5) Press the **▲** or **▼** button and select hose length from **~3M**, **3.1M~4M**, **4.1M~6M**, **6.1M~8M**, **8.1M~10M**.
- (6) Press the **APPLY** button pointing the transmitter of the remote controller at the indoor unit to set the hose length.
- (7) To return to the normal mode,
 - * press the **SET UP** button for 5 seconds.
 - * close the cover of the remote controller.
 - * leave the remote controller for 60 seconds.

(1) Open the cover.

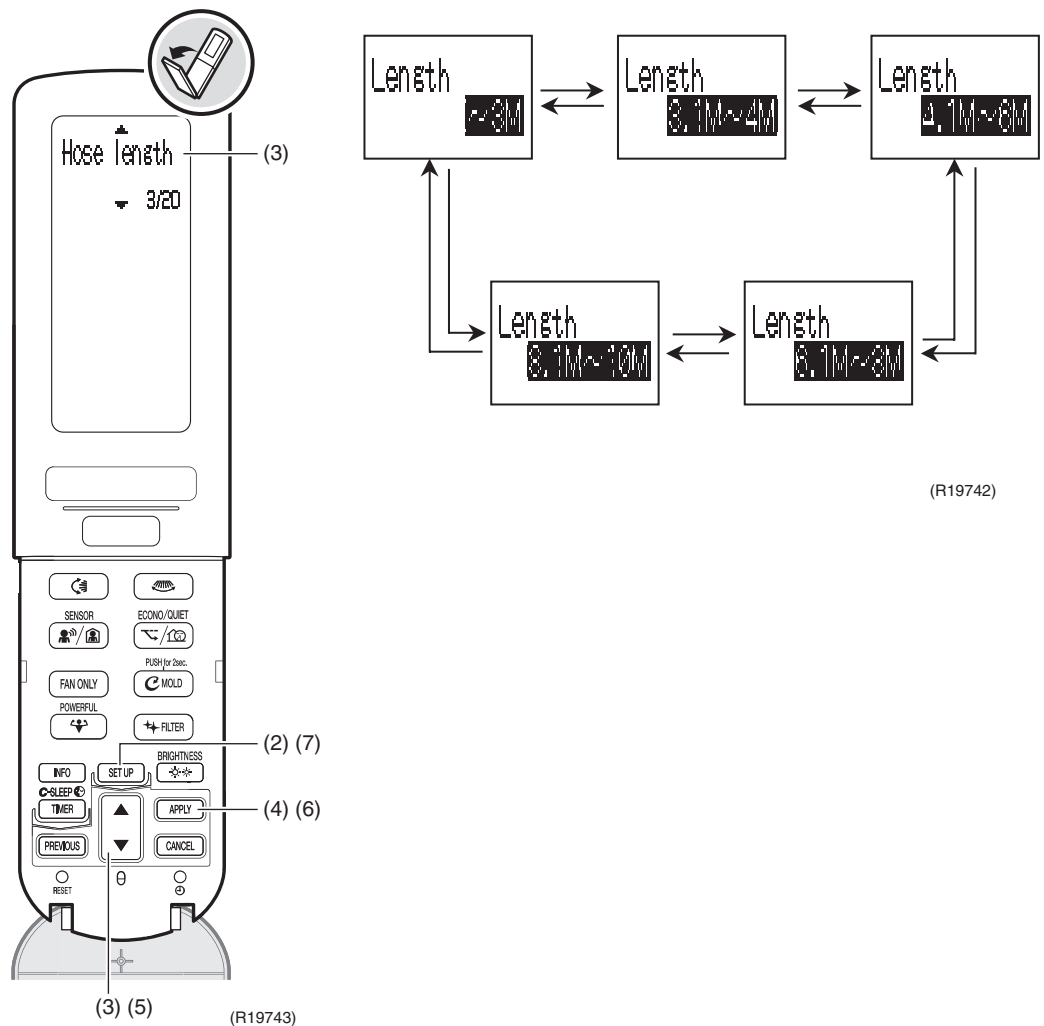

4. Silicone Grease on Power Transistor / Diode Bridge

Outline

Apply the specified silicone grease to the heat radiation part of a power transistor/diode bridge when you replace an outdoor unit PCB. The silicone grease encourages the heat radiation of a power transistor/diode bridge.

Details

1. Wipe off the old silicone grease completely.
2. Apply the silicone grease evenly. See the illustrations below for examples of application.
3. Tighten the screws of the power transistor/diode bridge.
4. Make sure that the heat radiation parts are firmly contacted to the radiation fin.

Note: Smoke emission may be caused by bad heat radiation when the silicone grease is not appropriately applied.

- OK: Evenly applied

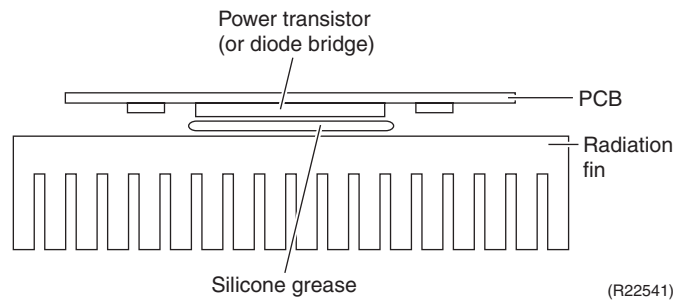

- NG: Not evenly applied

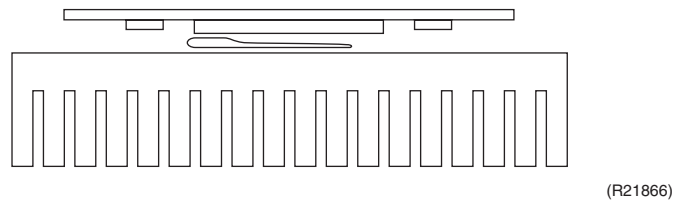

- NG: Foreign matter is stuck.

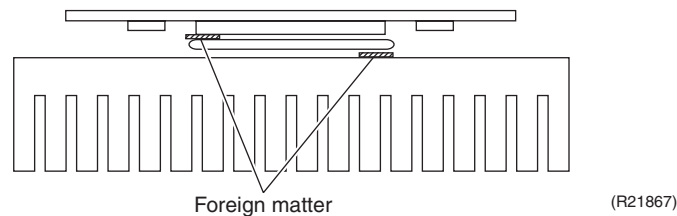

Part 8

Appendix

1. Piping Diagrams.....	202
1.1 Indoor Unit.....	202
1.2 Outdoor Unit.....	202
2. Wiring Diagrams.....	203
2.1 Indoor Unit.....	203
2.2 Outdoor Unit.....	204
3. Operation Limit.....	205

1. Piping Diagrams

1.1 Indoor Unit

FTXZ25/35/50NV1B

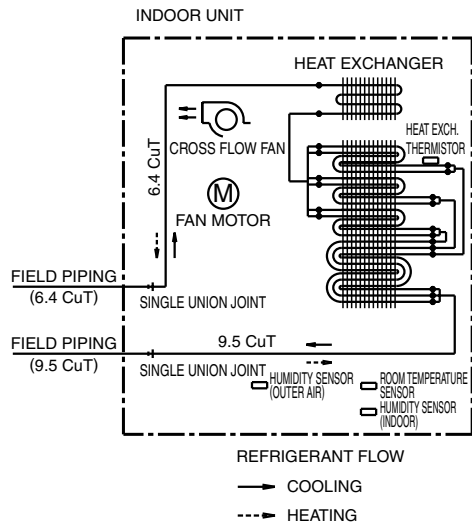

4D084172

1.2 Outdoor Unit

RXZ25/35/50NV1B

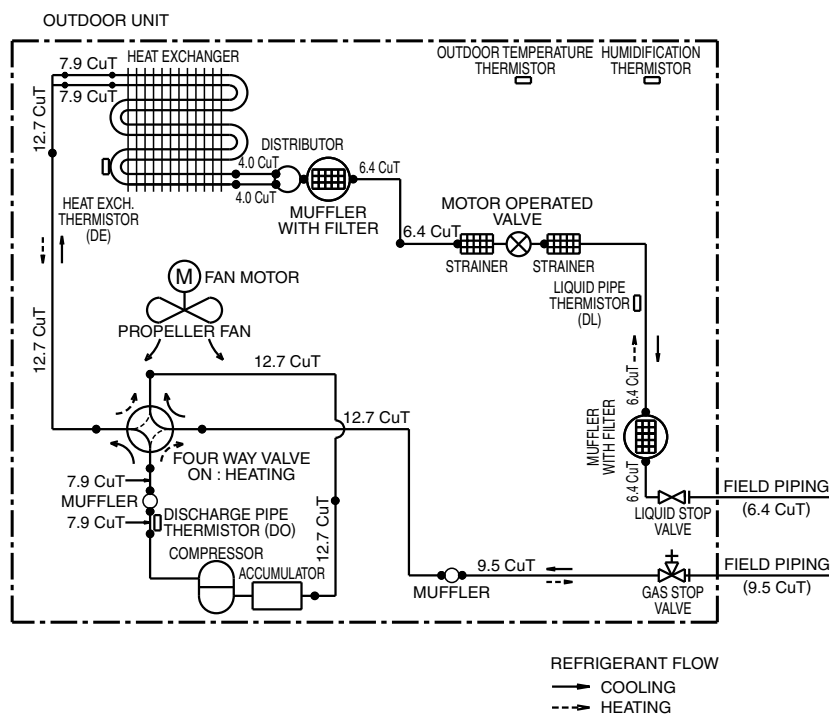

3D084174

2. Wiring Diagrams

2.1 Indoor Unit

FTXZ25/35/50NV1B

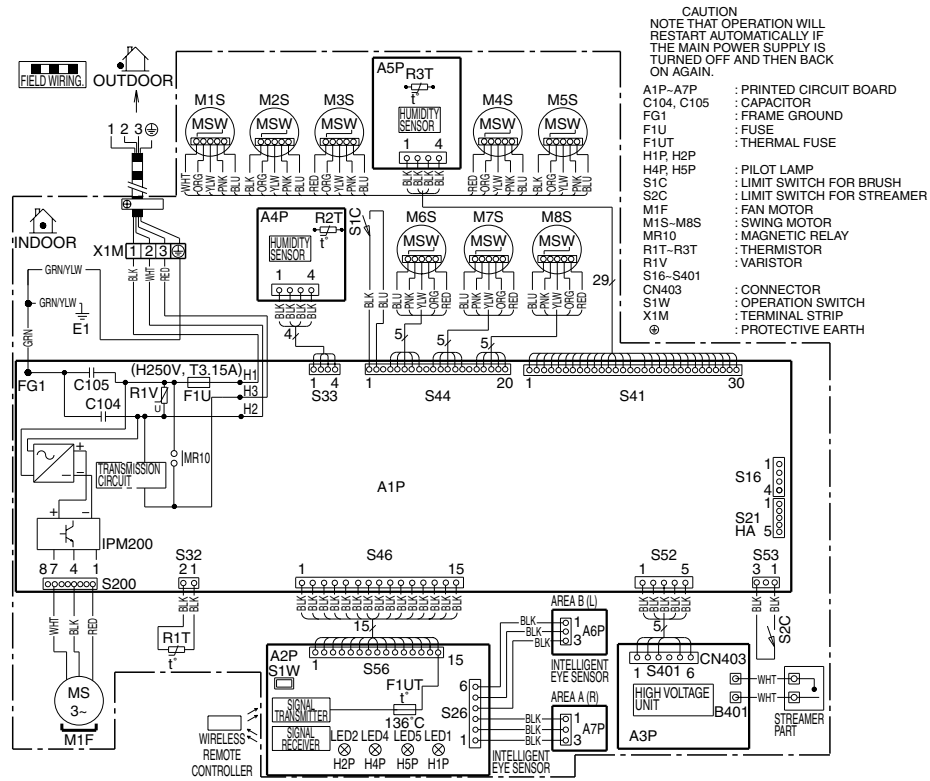

3D081990A



Note:

- A1P: Control PCB
 - A2P: Display/signal receiver PCB
 - A3P: High voltage unit PCB
 - A4P: Humidity sensor PCB for room
 - A5P: Humidity sensor PCB for humidifying
 - A6P, A7P: INTELLIGENT EYE sensor PCB
- Refer to P.7 for Printed Circuit Board Connector Wiring Diagram.

2.2 Outdoor Unit

RXZ25/35/50NV1B

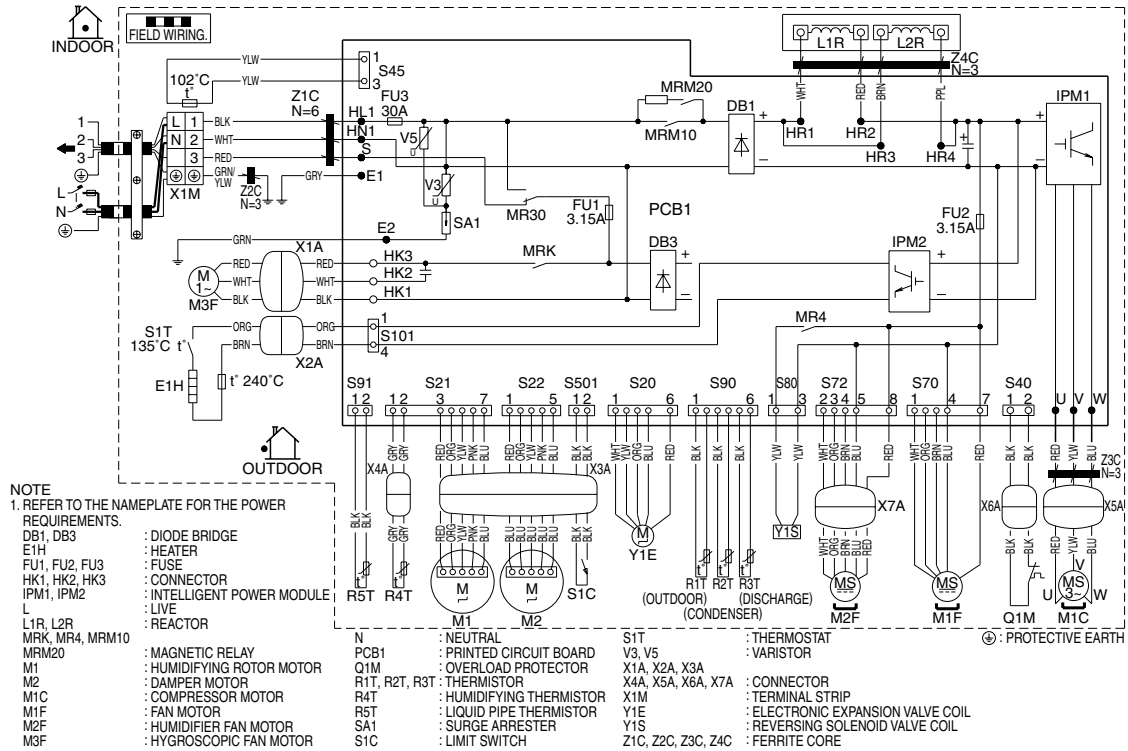

3D082027A



Note: PCB1: Main PCB
Refer to P.10 for Printed Circuit Board Connector Wiring Diagram.

3. Operation Limit

RXZ25/35/50NV1B

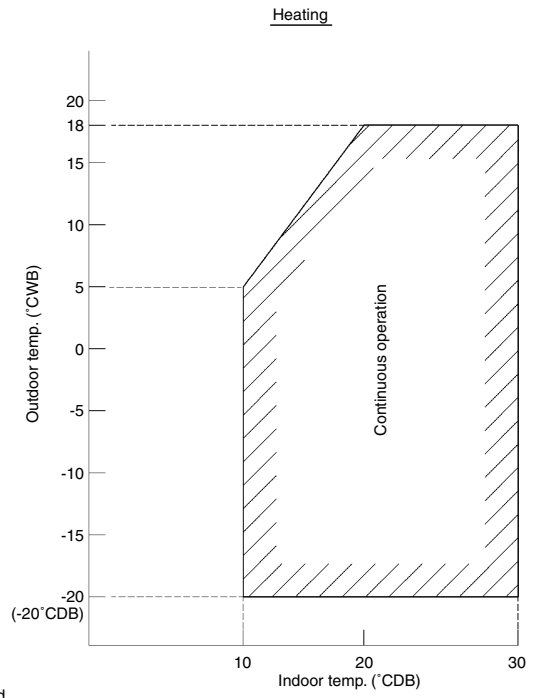
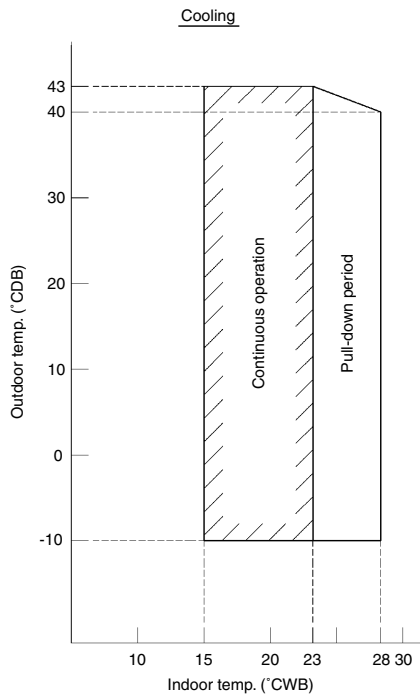

Notes:
 The graphs are based on the following conditions.

- Equivalent piping length
- Level difference
- Airflow rate

5.0m
 0m
 High

3D055735B

Revision History

Month / Year	Version	Revised contents
03 / 2014	SiMT041311E	First edition
10 / 2017	SiMT041311EA	Addition of error code

Warning



- Daikin products are manufactured for export to numerous countries throughout the world. Prior to purchase, please confirm with your local authorised importer, distributor and/or retailer whether this product conforms to the applicable standards, and is suitable for use, in the region where the product will be used. This statement does not purport to exclude, restrict or modify the application of any local legislation.
- Ask a qualified installer or contractor to install this product. Do not try to install the product yourself. Improper installation can result in water or refrigerant leakage, electrical shock, fire or explosion.
- Use only those parts and accessories supplied or specified by Daikin. Ask a qualified installer or contractor to install those parts and accessories. Use of unauthorised parts and accessories or improper installation of parts and accessories can result in water or refrigerant leakage, electrical shock, fire or explosion.
- Read the user's manual carefully before using this product. The user's manual provides important safety instructions and warnings. Be sure to follow these instructions and warnings.

If you have any enquiries, please contact your local importer, distributor and/or retailer.

Cautions on product corrosion

1. Air conditioners should not be installed in areas where corrosive gases, such as acid gas or alkaline gas, are produced.
2. If the outdoor unit is to be installed close to the sea shore, direct exposure to the sea breeze should be avoided. If you need to install the outdoor unit close to the sea shore, contact your local distributor.

Dealer

DAIKIN INDUSTRIES, LTD.

Head Office:
Umeda Center Bldg., 2-4-12, Nakazaki-Nishi,
Kita-ku, Osaka, 530-8323 Japan

Tokyo Office:
JR Shinagawa East Bldg., 2-18-1, Konan,
Minato-ku, Tokyo, 108-0075 Japan

<http://www.daikin.com/products/ac/>

©All rights reserved