



INSTALLATION MANUAL

VRV III System air conditioner **VRV III-Q** Series

MODELS

RQYQ140PY1	RQEQ140PY13
RQYQ180PY1	RQEQ180PY13
RQCYQ280PY1	RQEQ212PY13
RQCYQ360PY1	RQCEQ280PY13
RQCYQ460PY1	RQCEQ360PY13
RQCYQ500PY1	RQCEQ460PY13
RQCYQ540PY1	RQCEQ500PY13
	RQCEQ540PY13
	RQCEQ636PY13
	RQCEQ712PY13
	RQCEQ744PY13
	RQCEQ816PY13
	RQCEQ848PY13

Installation manual
VRV III System air conditioner

English

Installationsanleitung
VRV III System Klimaanlage

Deutsch

Manuel d'installation
Conditionneur d'air VRV III System

Français

Manual de instalación
Sistema de acondicionador de aire VRV III

Español

Manuale di installazione
Condizionatore d'aria a sistema VRV III

Italiano

Εγχειρίδιο εγκατάστασης
Κλιματιστικό με σύστημα VRV III

Ελληνικά

Installatiehandleiding
Airconditioner met VRV III System

Nederlands

Manual de instalação
Ar condicionado VRV III System

Português

Руководство по монтажу
Кондиционер системы VRV III

Русский

Montaj elkitabı
VRV III System Klima

Türkçe

[Q140~212 type]

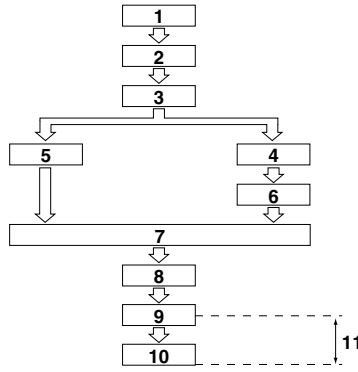
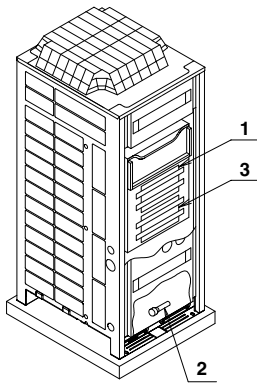

< If installed as a single unit >

(Pattern 1)

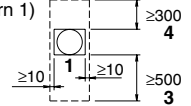

< If installed as a serial installation >

(Pattern 1)

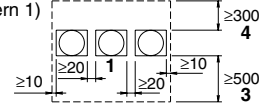

(Pattern 2)

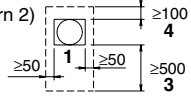

(Pattern 2)

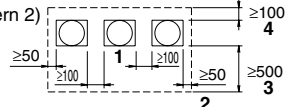

(Pattern 3)

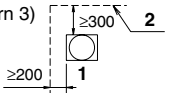

(Pattern 3)

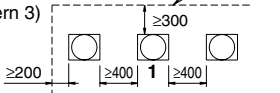

figure 1

figure 2

figure 3

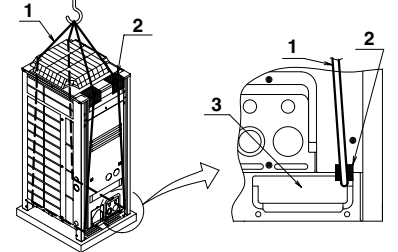
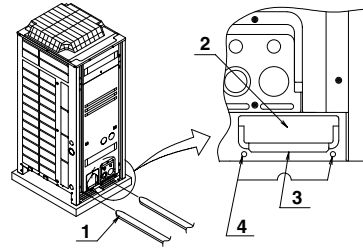
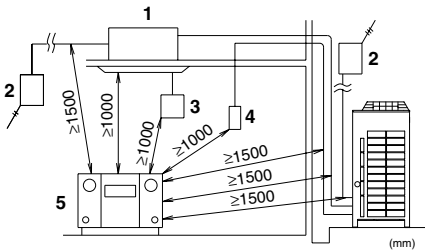

figure 4

figure 5

figure 6

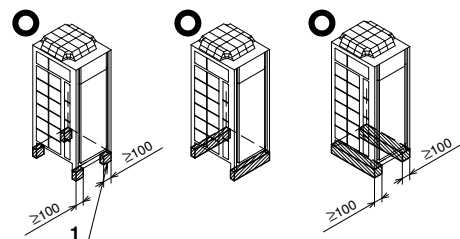
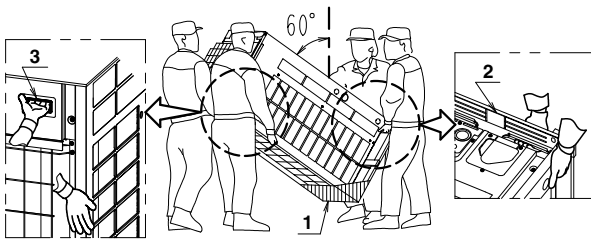

figure 7

figure 8

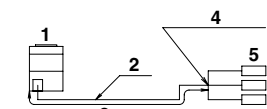
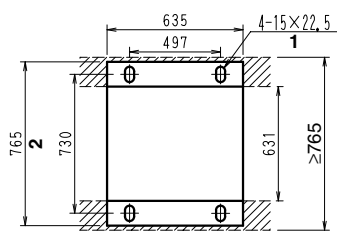

figure 10.1

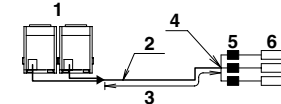

figure 10.2

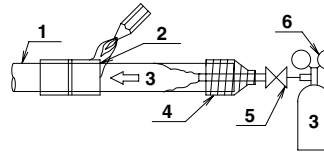

figure 11

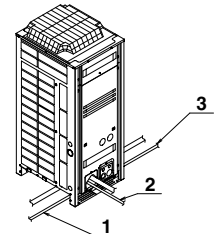

figure 12

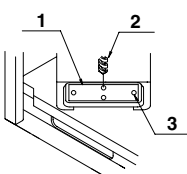

figure 13

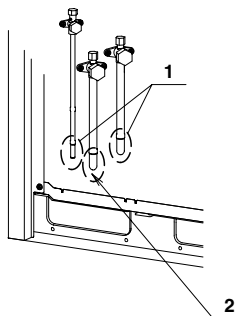

figure 14.1

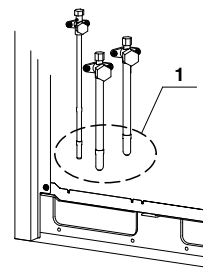

figure 14.2

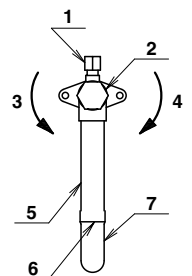

figure 14.3

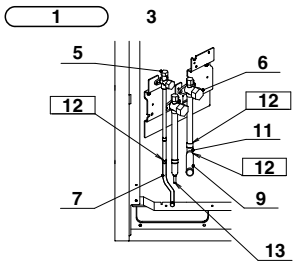

figure 15.1

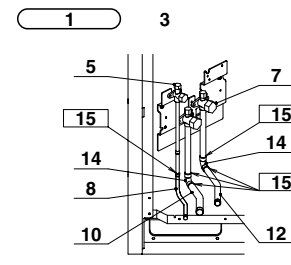
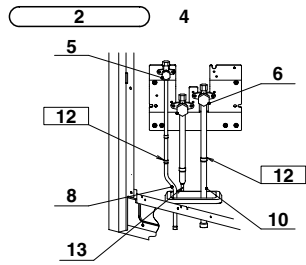

figure 15.2

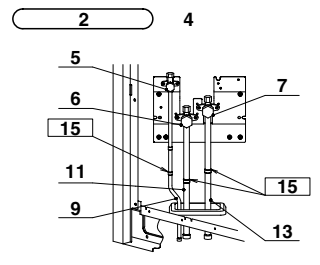

figure 16

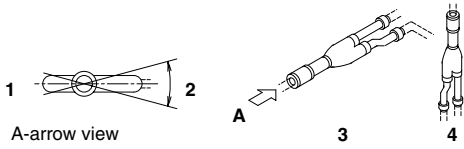

figure 17

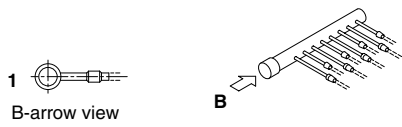

figure 18

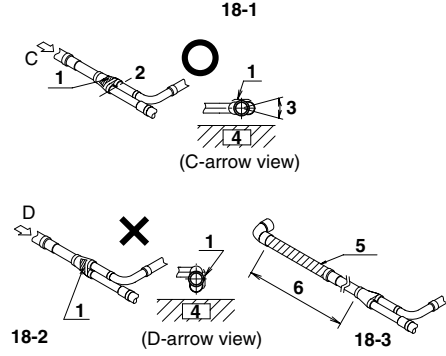

figure 19.1

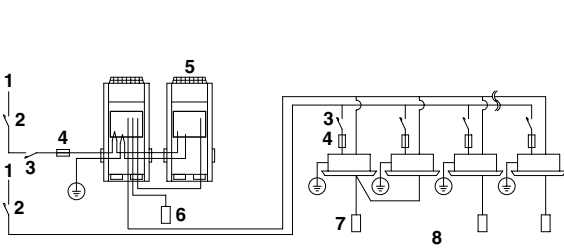

figure 19.2

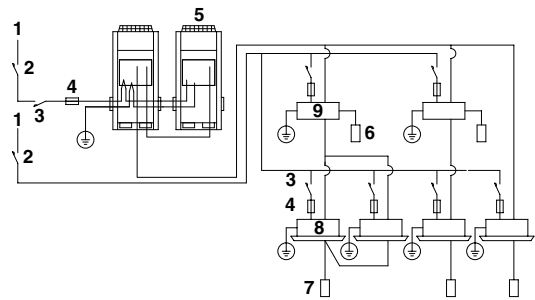

figure 20

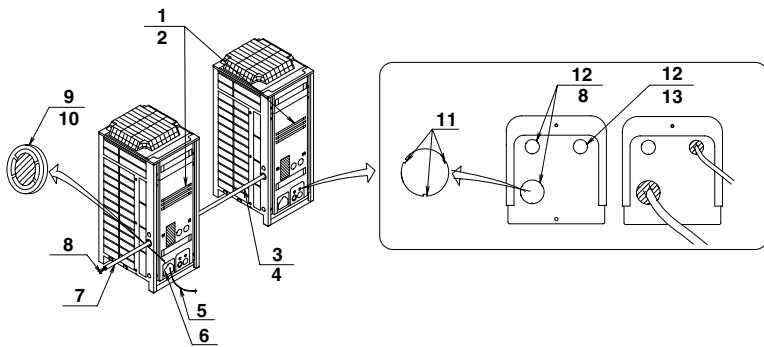

figure 21.2

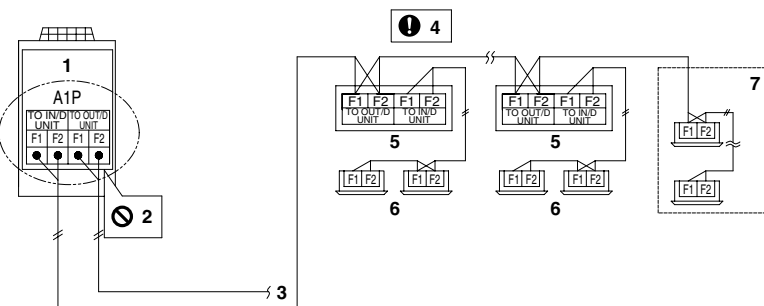

figure 21.1

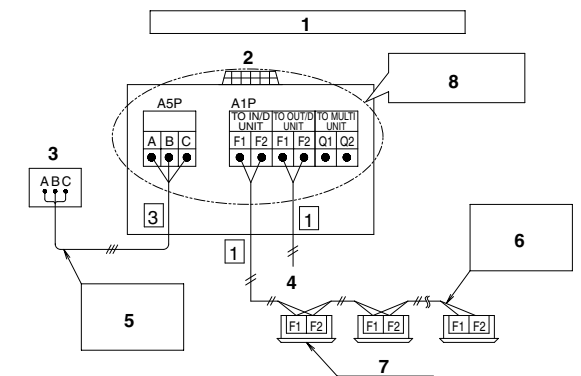
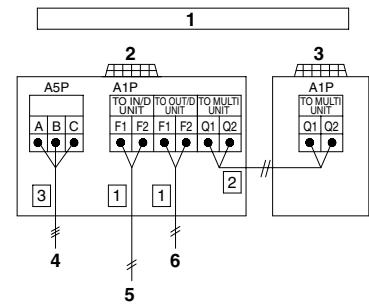

figure 22



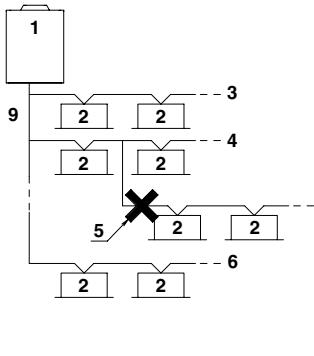

figure 23

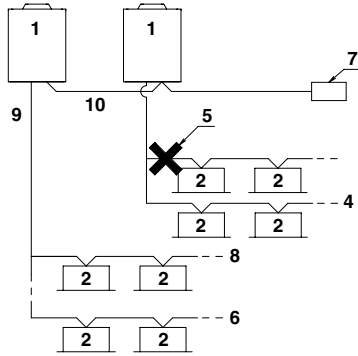

figure 24

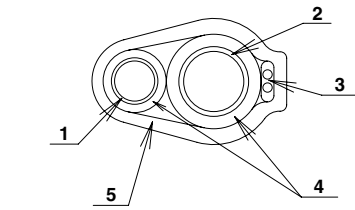
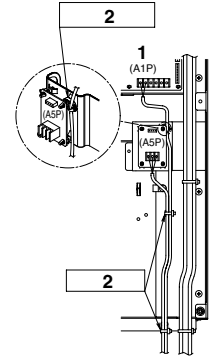

figure 25.1

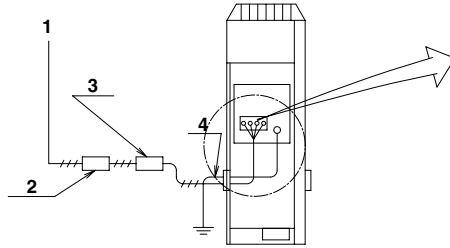

figure 25.2

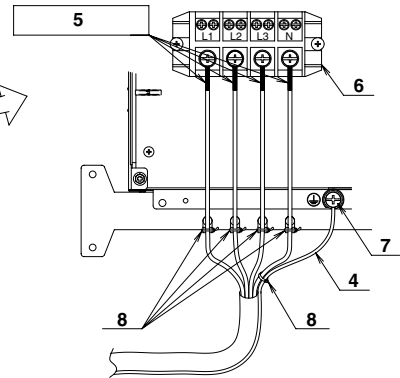

figure 26

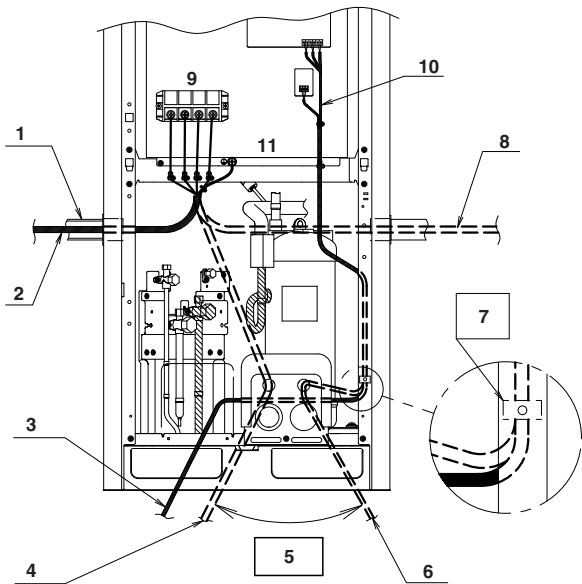

figure 27

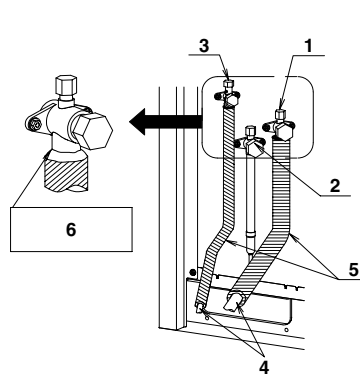

figure 29.1

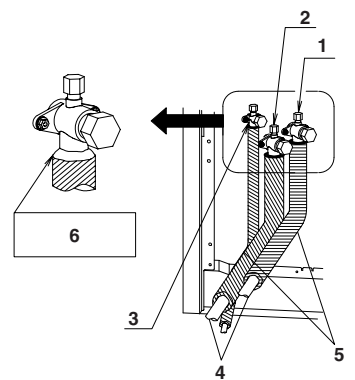

figure 29.2

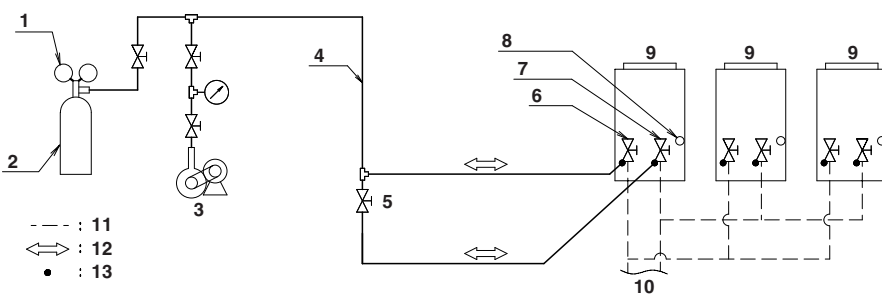

figure 28.1

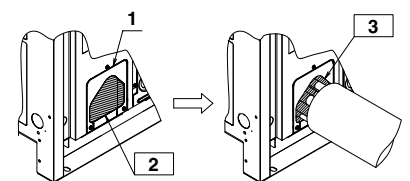

figure 30

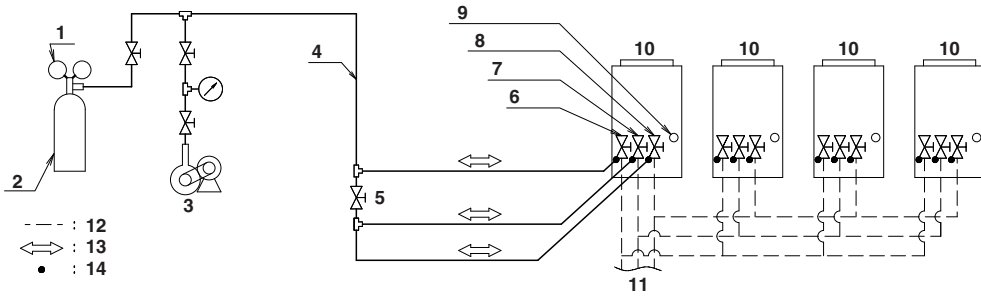

figure 28.2

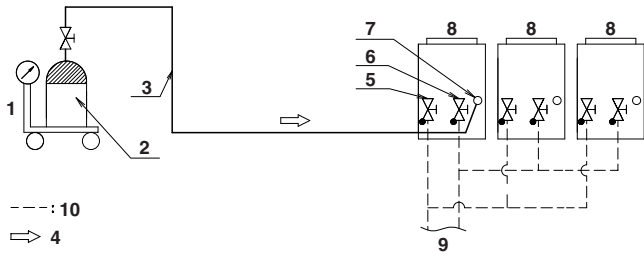

figure 31.1

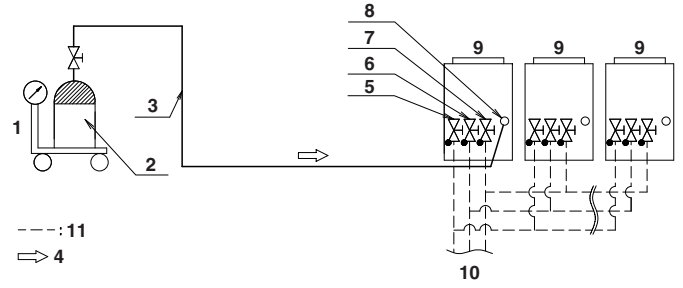

figure 31.2

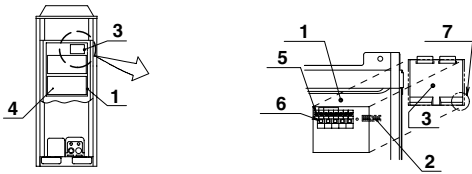

figure 32

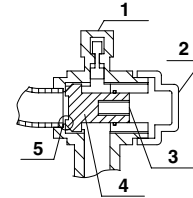

figure 33

CONTENTS

1. FIRST OF ALL	1
1-1. Safety precautions	1
1-2. Special notice of product	2
1-3. Disposal requirements	3
2. INTRODUCTION	3
2-1. Combination	3
2-2. Standard supplied accessories	3
2-3. Option accessory	4
2-4. Technical and Electrical specifications	4
2-5. Main components	4
2-6. Installation Process	4
3. SELECTION OF LOCATION	4
4. INSPECTING AND HANDLING THE UNIT	5
5. PLACING THE UNIT	5
6. REFRIGERANT PIPING	5
6-1. Selection of piping material and Refrigerant branching kit	5
6-2. Protection against contamination when installing pipes	6
6-3. Pipe connection	6
6-4. Connecting the refrigerant piping	6
6-5. Example of connection	9
7. FIELD WIRING	15
7-1. Power circuit, safety device, and cable requirements ..	15
7-2. Wiring Connection Example for Whole System	16
7-3. Leading wire Procedure	16
7-4. Transmission Wiring Connection Procedure	16
7-5. Power Wiring Connection Procedure	17
7-6. Procedure for Wiring Inside Units	17
8. AIR TIGHT TEST AND VACUUM DRYING	17
8-1. Preparations	18
8-2. Air tight test and vacuum drying method	18
9. PIPE INSULATION	18
10. CHECKING OF DEVICE AND INSTALLATION CONDITIONS	19
11. ADDITIONAL REFRIGERANT CHARGE AND CHECK OPERATION	19
11-1. Before working	19
11-2. Procedure of check operation	20
12. ONSITE SETTINGS	26
12-1. Onsite Settings With the Power Off	26
12-2. Onsite Settings With the Power On	26
13. TEST RUN	26
13-1. Before test run	26
13-2. Test Run	26
13-3. Checks After Test Run	26
14. CAUTION FOR REFRIGERANT LEAKS	26

The English text is the original instruction. Other languages are translations of the original instructions.

1. FIRST OF ALL

- Use the BS unit with Heat Recovery series (RQCEQ).
- This document is an installation manual for the Daikin VRVIII-Q Series VRV Inverter. Before installing the unit, read this manual thoroughly, and following the instructions contained in it. After installation, do a test run to make sure the unit runs properly, and then explain how to operate and take care of the unit to the customer, using the operation manual.
- Lastly, make sure the customer keeps this manual, along with the operation manual, in a safe place.
- This manual does not describe how to install the indoor unit. Refer to the installation manual included with the indoor unit for that.

1-1 Safety precautions

Please read these "Safety precautions" carefully before installing air conditioning equipment and be sure to install it correctly.

Meaning of WARNING and CAUTION notices.

Both are important notices for safety. Be sure to follow them.



WARNING Failure to follow these instructions properly may result in personal injury or loss of life.



CAUTION Failure to observe these instructions properly may result in property damage or personal injury, which may be serious depending on the circumstances.

After completing installation, conduct a test operation to confirm that the equipment operates without any problems. Then, explain to the customer how to operate the equipment and take care of it following the operation manual. Ask the customer to store the installation manual along with the operation manual for future reference.

This air conditioner comes under the term "appliances not accessible to the general public".

VRV System is a class A product. In a domestic environment this product may cause radio interference in which case the user may be required to take adequate measures.



WARNING

- Ask your dealer or qualified personnel to carry out installation work.
Do not attempt to install the air conditioner yourself. Improper installation may result in water leakage, electric shocks or fire.
- Install the air conditioner in accordance with the instructions in this installation manual.
Improper installation may result in water leakage, electric shocks or fire.
- When installing the unit in a small room, take measures so that the refrigerant may not exceed the limiting concentration in the event of refrigerant leakage.
Contact your dealer for further information. If the refrigerant leaks and exceeds the limiting concentration, it may lead to oxygen deficiency.
- Be sure to use only the specified accessories and parts for installation work.
Failure to use the specified parts may result in the unit falling, water leakage, electric shocks or fire.
- Install the air conditioner on a foundation strong enough to withstand the weight of the unit.
If a foundation does not have sufficient strength, the equipment may fall and cause injury.
- Carry out the required installation work in consideration of strong winds, typhoons or earthquakes.
If the installation work is not properly carried out, the unit may fall down and cause accidents.
- The electrical work must be carried out by the qualified electrician in accordance with the local laws and regulations and this installation manual. Make sure to provide a dedicated power supply circuit and never connect additional wiring to the existing circuit.
An insufficient power supply capacity or improper electrical work may lead to electric shocks or fire.
- Be sure to earth the air conditioner.
Do not earth the unit to a utility pipe, lightning conductor or telephone earth lead.
Imperfect earthing may result in electric shocks or fire.
A high surge current from lightning or other sources may cause damage to the air conditioner.
- Be sure to install an earth leakage breaker.
Failure to install an earth leakage breaker may result in electric shocks or fire.
- Be sure to switch off the unit before touching any electrical parts.
Touching a live part may result in electric shock.

- For wiring, use the specified wires and connect and fasten them firmly so that no external force from the wires may be applied to the terminal connections.
If the wires are not firmly connected and fastened, it may cause heating, fire or the like.
- When wiring the power supply and connecting the remote controller wiring and transmission wiring, position the wires so that the EL.COMPO.BOX lid can be securely fastened.
Improper positioning of the EL.COMPO.BOX lid may result in electric shocks, fire or the terminals overheating.
- If refrigerant gas leaks during installation, ventilate the area immediately.
Toxic gas may be produced if the refrigerant comes into contact with fire.
- After completing installation, check for refrigerant gas leakage.
Toxic gas may be produced if the refrigerant gas leaks into the room and comes into contact with a source of fire, such as a fan heater, stove or cooker.
- Do not directly touch refrigerant that has leaked from refrigerant pipes or other areas, as there is a danger of frostbite.
- Do not allow children to climb on the outdoor unit and avoid placing objects on the unit.
Injury may result if the unit becomes loose and falls.

CAUTION

- Carry out drain piping properly following this installation manual and insulate the pipe to prevent condensation.
Improper drain piping may result in indoor water leakage and property damage.
- Install the indoor, BS and outdoor units, power cord and connecting wires at least 1 meter away from televisions or radios to prevent picture interference and noise.
(Depending on the incoming signal strength, a distance of 1 meter may not be sufficient to eliminate noise.)
- Install the indoor unit and BS unit as far as possible from fluorescent lamps.
If a wireless kit is installed in a room where the electronic lighting type (inverter or rapid start types) fluorescent lamps exist, the transmitting distance of a remote controller may be shorter.
- Make sure to provide for adequate measures in order to prevent that the outdoor unit be used as a shelter by small animals.
Small animals making contact with electrical parts can cause malfunctions, smoke or fire.
Please instruct the customer to keep the area around the unit clean.
- Do not install the air conditioner in the following locations:
 1. Where there is a high concentration of mineral oil spray or vapour (e.g. a kitchen).
Plastic parts may deteriorate and cause parts to fall off or water to leak.
 2. Where corrosive gas, such as sulphurous acid gas, is produced.
Corrosion of copper pipes or brazed parts may occur and cause refrigerant leakage.
 3. Where there is a machine that generates electromagnetic wave and where voltage fluctuation often occurs such as a factory.
Control system may malfunction and as a result the unit may not properly operate.
 4. Where flammable gas may leak, where carbon fibre or ignitable dust is suspending in the air, or where volatile flammables such as paint thinner or gasoline are handled.
Operating the unit in such conditions may result in fire.
- The air conditioner is not intended for use in a potentially explosive atmosphere.

1-2 Special notice of product

[CLASSIFICATION]

This air conditioner comes under the term "appliances not accessible to the general public".

[EMC CHARACTERISTICS]

VRVIII System is a class A product. In a domestic environment this product may cause radio interference in which case the user may be required to take adequate measures.

[REFRIGERANT]

VRVIII System use R410A refrigerant.

- The refrigerant R410A requires that strict precautions be observed for keeping the system clean, dry and tightly sealed.
Read the chapter "REFRIGERANT PIPING" carefully and follow these procedures correctly.

A. Clean and dry

Strict measures must be taken to keep impurities (including fluid, dirt and dust) out of the system.

B. Tightly sealed

R410A contains no chlorine, does not destroy the ozone layer and so does not reduce the earth's protection against harmful ultraviolet radiation. R410A will contribute only slightly to the greenhouse effect if released into the atmosphere. Therefore, sealing tightness is particularly important in installation. Carefully read the chapter "REFRIGERANT PIPING" and strictly observe the correct procedures.

- As the design pressure for local connection piping (suction-HP/LP gas pipe, gas pipe, and liquid pipe) is at least 3.3 MPa, it is possible to use existing piping (design pressure of at least 3.3 MPa,) but refer to "6. REFRIGERANT PIPING" and check that existing piping (including branch piping) is compatible with this unit in terms of materials and thickness and that it does not appear to be corroded.
Air tight test (3.3 MPa 24/h) to check the strength of existing piping and that it has no gas leaks.
If it is not possible to perform a pressure test, replace existing piping with piping rated at least 3.3 MPa.
- Check that there has not been compressor malfunction, gas supply exhaustion, or similar issues that could be attributable to pipe problems in the past. If there have been any such problems, check that appropriate repairs were made, and if not, implement such repairs.
- Existing power supply and transmission wiring is also designed to be used with existing wiring, but check that specifications match and that parts (especially terminals) do not appear to have aged, and implement appropriate procedures (e.g. replacement).
- Since R410A is a mixed refrigerant, the required additional refrigerant must be charged in its liquid state. (If the system is charged with refrigerant in its gaseous state, due to composition change, the system will not function normally).
- The indoor unit is designed for R410A use. See the catalogue for indoor unit models that can be connected. (Normal operation is not possible when connecting units that are originally designed for other refrigerants.)
- The Heat Recovery Series (RQCEQ) cannot be connected to older BS units (BSVQ-M Type).

Total maximum refrigerant charge limits.

The total maximum refrigerant charge of a VRVIII system must be below 100kg, this to be in accordance with CE requirement (EN60335-2-40 standard).

This means that in case the total maximum refrigerant charge of the system (factory and additional charge) is equal to or more than 100kg you must divide your multiple outdoor system into smaller independent systems, each containing less than 100kg refrigerant charge. For factory charge, refer to the unit name plate.

Important information regarding the refrigerant used.

This product contains fluorinated greenhouse gases covered by the Kyoto Protocol. Do not vent gases into the atmosphere.

Refrigerant type : R410A

GWP ⁽¹⁾ value : 1975

⁽¹⁾ GWP = global warming potential

Please fill in with indelible ink,

- ① the factory refrigerant charge of the product,
- ② the additional refrigerant amount charged onsite and
- ① + ② the total refrigerant charge on the refrigerant charge label supplied with the product.

The filled out label must be adhered in the proximity of the product charging port (e.g. onto the inside of the service cover).

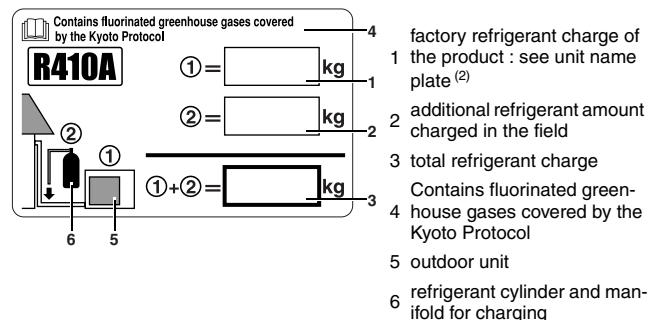

(2) In case of multiple outdoor systems, only 1 label must be adhered, mentioning the total factory refrigerant charge of all outdoor units connected on the refrigerant system.

[DESIGN PRESSURE]

- As the design pressure for local connection piping (suction-HP/LP gas pipe, gas pipe, and liquid pipe) is at least 3.3 MPa, it is possible to use existing piping (design pressure of at least 3.3 MPa) but refer to "6. REFRIGERANT PIPING" and check that existing piping (including branch piping) is compatible with this unit in terms of materials and thickness and that it does not appear to be corroded.
Air tight test (3.3 MPa 24/h) to check the strength of existing piping and that it has no gas leaks.
If it is not possible to perform a pressure test, place existing piping with piping rated at least 3.3 MPa.
- Check that there has been no compressor malfunction, gas supply exhaustion, or similar issues that could be attributable to pipe problems in the past. If there have been any such problems, check that appropriate repairs were made, and if not, implement such repairs.

1-3 Disposal requirements

Dismantling of the unit, treatment of the refrigerant, of oil and of other parts must be done in accordance with relevant local and national legislation.

2. INTRODUCTION

- VRV8-Q series are designed for outdoor installation and used for cooling and heat pump applications. Outdoor units come in three standard sizes, and with a single system through a multi system combining up to three outdoor units (Heat Pump series), and up to four outdoor units (Heat Recovery series). Rated capacity is below.
RQ(C)YQ: Cooling 14.0~54.0 kW, Heating 16.0~60.0 kW
RQCEQ: Cooling 28.0~84.8 kW, Heating 32.0~89.6 kW
- The BS units that combined with RQCEQ system for changing the refrigerant flow to indoor units are A type (BSQ-AV1, BS1Q-A7V1B, BS-Q14AV1) and P type (BSVQ-P, BSV-Q100P) only. Combination with A type and P type cause malfunction.
- The VRV units can be combined with Daikin VRV series indoor units for air conditioning purposes. Always use appropriate indoor units compatible with R410A. To learn which models of indoor units are compatible with R410A, refer to the product catalogs. Combination with other indoor refrigerant units will cause malfunction.

2-1 Combination

The indoor units can be installed in the following range.

- Heat Pump series (RQ(C)YQ)**

<Outdoor unit>	<Total capacity of indoor units>	<Total quantity of indoor units>
RQYQ140PY1	7.0 ~ 18.2	8 units
RQYQ180PY1	9.0 ~ 23.4	10 units
RQCYQ280PY1	14.0 ~ 36.4	16 units
RQCYQ360PY1	17.8 ~ 46.2	20 units
RQCYQ460PY1	22.5 ~ 58.5	26 units
RQCYQ500PY1	25.0 ~ 65.0	29 units
RQCYQ540PY1	28.0 ~ 72.8	33 units
- Heat Recovery series (RQCEQ)**

<Outdoor unit>	<Total capacity of indoor units>	<Total quantity of indoor units>
RQCEQ280PY13	14.0 ~ 36.4	16 units
RQCEQ360PY13	17.8 ~ 46.2	20 units
RQCEQ460PY13	22.5 ~ 58.5	26 units
RQCEQ500PY13	25.0 ~ 65.0	29 units
RQCEQ540PY13	28.0 ~ 72.8	33 units
RQCEQ636PY13	30.8 ~ 80.0	36 units
RQCEQ712PY13	34.5 ~ 89.7	40 units
RQCEQ744PY13	36.5 ~ 94.9	43 units
RQCEQ816PY13	40.0 ~ 104	47 units
RQCEQ848PY13	42.5 ~ 111	50 units

Note

- Be sure to connect an R410A indoor unit.
See the catalog for indoor unit models which can be connected.
- Above is the total capacity and total number of units of the indoor units when configured in a standard combination. See the technical reference for details on total capacity and total number of indoor units when using a configuration other than the standard combination. The standard combinations are as follows.

- Heat Pump series (RQ(C)YQ)**

<Combination unit>	<Independent unit>
RQYQ140PY1	RQYQ140PY1
RQYQ180PY1	RQYQ180PY1
RQCYQ280PY1	RQYQ140PY1+RQYQ140PY1
RQCYQ360PY1	RQYQ180PY1+RQYQ180PY1
RQCYQ460PY1	RQYQ180PY1+RQYQ140PY1+RQYQ140PY1
RQCYQ500PY1	RQYQ180PY1+RQYQ180PY1+RQYQ140PY1
RQCYQ540PY1	RQYQ180PY1+RQYQ180PY1+RQYQ180PY1
- Heat Recovery series (RQCEQ)**

<Combination unit>	<Independent unit>
RQCEQ280PY13	RQEQ140PY13+RQEQ140PY13
RQCEQ360PY13	RQEQ180PY13+RQEQ180PY13
RQCEQ460PY13	RQEQ180PY13+RQEQ140PY13+RQEQ140PY13
RQCEQ500PY13	RQEQ180PY13+RQEQ180PY13+RQEQ140PY13
RQCEQ540PY13	RQEQ180PY13+RQEQ180PY13+RQEQ180PY13
RQCEQ636PY13	RQEQ212PY13+RQEQ212PY13+RQEQ212PY13
RQCEQ712PY13	RQEQ212PY13+RQEQ180PY13+RQEQ180PY13+RQEQ140PY13
RQCEQ744PY13	RQEQ212PY13+RQEQ212PY13+RQEQ180PY13+RQEQ140PY13
RQCEQ816PY13	RQEQ212PY13+RQEQ212PY13+RQEQ212PY13+RQEQ180PY13
RQCEQ848PY13	RQEQ212PY13+RQEQ212PY13+RQEQ212PY13+RQEQ212PY13

Note

- Combinations other than those above are prohibited.
- If the total capacity of the connected indoor units exceeds the capacity of the outdoor unit, cooling and heating performance may drop when running the indoor units. See the capacity table in the Engineering Data Book for details.
- There are restrictions on the refrigerant pipe connecting order between outdoor unit in the case of the multi system. Install so that the following restrictions are satisfied.
<Restrictions>
The capacities of outdoor units A and B must fulfill the following conditions.
A ≥ B

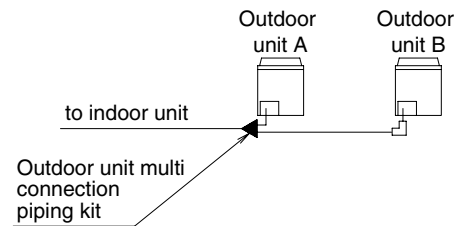

2-2 Standard supplied accessories

The following accessories are included. The storage location of the accessories is shown in figure 1.

- Heat Pump series (RQYQ)**

Name	Gas side accessory pipe (1)	Gas side accessory pipe (2)	Liquid side accessory pipe (1)	Liquid side accessory pipe (2)	L type accessory joint
Quantity	1 pc.	1 pc.	1 pc.	1 pc.	1 pc.
Shape	(Long)	(Short)			
Name	Clamp (1)	Clamp (2)	Clamp (3)	Others	
Quantity	1 pc.	8 pcs.	1 pc.	1 pc. each item	
Shape	(Large)	(Small)		<ul style="list-style-type: none"> Operation manual Installation manual Declaration conformity (PED, EMC, MD) "REQUEST FOR THE INDICATION" label (Installation records) "ADDITIONAL REF. CHARGE" label 	

• Heat Recovery series (RQEQ)

Name	Suction gas side accessory pipe (1)	Suction gas side accessory pipe (2)	HP/LP gas side accessory pipe (1)	HP/LP gas side accessory pipe (2)	Liquid side accessory pipe (1)	Liquid side accessory pipe (2)
Quantity	1 pc.	1 pc.	1 pc.	1 pc.	1 pc.	1 pc.
Shape						
	Q140 type: ϕ 15.9, Q180-212 type: ϕ 19.1		Q140 type: ϕ 12.7, Q180-212 type: ϕ 15.9			
Name	L type accessory joint	Clamp (1)	Clamp (2)	Clamp (3)	Others	
Quantity	2 pcs.	1 pc.	8 pcs.	1 pc.	1 pc. each item	
Shape					<ul style="list-style-type: none"> • Operation manual • Installation manual • Declaration conformity (PED, EMC, MD) • "REQUEST FOR THE INDICATION" label (Installation records) • "ADDITIONAL REF. CHARGE" label 	
		(Large)	(Small)			

(Refer to figure 1)

1. Clamps, Operation manual, etc.
2. Accessory pipes
3. Installation manual

Note

Do not throw away any of the accessories until installation is complete.

2-3 Option accessory

To install the outdoor units, the following optional parts are also required. To select an optimum kit, refer to "6-5 Example of connection".

• Refrigerant branching kit

If it is not possible to use existing branch piping or if it is necessary to install new piping when installing refrigerant piping to BS/indoor units, the following parts are required. (Be sure to use branch piping of at least the design pressure of 3.3 MPa.)

• Heat Pump series (RQ(C)YQ)

REFNET header	KHRP26M22H	KHRP26M33H	KHRP26M72H	KHRP26M73H
REFNET joint	KHRP26A22T	KHRP26A33T	KHRP26A72T	KHRP26A73T

• Heat Recovery series (RQCEQ)

	for 3 piping		for 2 piping	
REFNET header	-	KHRP25M33H	KHRP26M22H	KHRP26M33H
	KHRP25M72H	KHRP25M73H	KHRP26M72H	KHRP26M73H
REFNET joint	KHRP25A22T	KHRP25A33T	KHRP26A22T	KHRP26A33T
	KHRP25A72T	KHRP25A73T	KHRP26A72T	KHRP26A73T

• Outdoor unit multi connection piping kit

• Heat Pump series (RQ(C)YQ)

	Kit name
2 units	BHFP22P36C
3 units	BHFP22P54C

• Heat Recovery series (RQCEQ)

	Kit name
2 units	BHFP26P36C
3 units	BHFP26P63C
4 units	BHFP26P84C

Note

Make sure that any separately purchased accessories are designed for use with R410A.

2-4 Technical and Electrical specifications

Refer to the Engineering Data Book for the complete list of specifications.

2-5 Main components

For main components and function of the main components, refer to the Engineering Data Book.

2-6 Installation Process

Figure 2 shows the installation process. Install in the order of the steps shown.

(Refer to figure 2)

1. "3. SELECTION OF LOCATION"
2. "4. INSPECTING AND HANDLING THE UNIT"
3. "5. PLACING THE UNIT"
4. "6. REFRIGERANT PIPING"
5. "7. FIELD WIRING"
6. "8. AIR TIGHT TEST AND VACUUM DRYING"
7. "9. PIPE INSULATION"
8. "10. CHECKING OF DEVICE AND INSTALLATION CONDITIONS"
9. "11. ADDITIONAL REFRIGERANT CHARGE AND CHECK OPERATION"
10. "13. TEST RUN"
11. Operations which require the power to be turned on

3. SELECTION OF LOCATION

Select a location for installation that meets the following conditions. Get the customer's permission.

1. There is no danger of fire due to leakage of flammable gas.
2. Select the location of the unit in such a way that neither the discharged air nor the sound generated by the unit disturb anyone.
3. The foundation is strong enough to support the weight of the unit and the floor is flat to prevent vibration and noise generation.
4. The piping length between the outdoor unit and the indoor unit may not exceed the allowable piping length. (Refer to "6. REFRIGERANT PIPING")
5. Locations where the unit's suction vent and outlet vent do not directly face the wind. Wind blowing directly into the suction or outlet vents will interfere with the unit's operation. If necessary, install some kind of obstruction to block the wind.
6. The space around the unit is adequate for servicing and the minimum space for air inlet and air outlet is available. (See the "Installation Space Examples" for the minimum space requirements.)

Installation Space Examples.

- The installation space requirement shown in figure 3 is a reference for cooling operation when the outdoor temperature is 35°C. If the design outdoor temperature exceeds 35°C or the heat load exceeds maximum capacity in all the outdoor unit, take an even large space on the intake shown in figure 3.
- During installation, install the units using the most appropriate of the patterns shown in figure 3 for the location in question, taking into consideration human traffic and wind.
- If the number of units installed is more than that is shown in the pattern in figure 3, install the units so there are no short circuits.
- As regards space in front of the unit, consider the space needed for the local refrigerant piping when installing the units.
- If the work conditions in figure 3 do not apply, contact your dealer or Daikin directly.

(Refer to figure 3)

1. Front side
2. No limit to wall height
3. Service space of front side
4. Service space of suction side

For Patterns 1 and 2 in figure 3:

- Wall height for the front side should be no higher than 1500 mm.
- Wall height for the suction side should be no higher than 500 mm.
- Wall height for the sides – no limit.

- If the height is exceeded the above, calculate h1 and h2 shown in the figure below, and add h1/2 to the service space of front side and h2/2 to the service space of suction side.

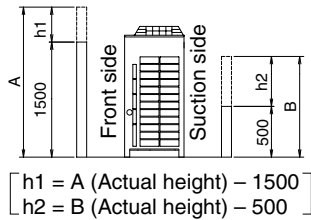

Note

- An inverter air conditioner may cause electronic noise generated from AM broadcasting. Examine where to install the main air conditioner and electric wires, keeping proper distances away from stereo equipment, personal computers, etc. Particularly for locations with weak reception, ensure there is a distance of at least 3 meters for indoor remote controllers, place power wiring and transmission wiring in conduits, and ground the conduits.

(Refer to figure 4)

- Indoor unit
 - Branch switch, overcurrent breaker, earth leakage circuit breaker
 - Remote controller
 - COOL/HEAT selector
 - Personal computer or radio
- When installing in a locations where there is heavy snowfall, implement the following snow measures.
 - Ensure the base is high enough that intakes are not clogged by snow.
 - Remove the rear intake grille to prevent snow from accumulating on the fins.
 - If condensate may drip downstairs (or walkway) depending on the floor condition, take a measure such as the installation of central drain pan kit (sold separately).
 - The refrigerant R410A itself is nontoxic, nonflammable and is safe. If the refrigerant should leak however, its concentration may exceed the allowable limit depending on room size. Due to this it could be necessary to take measures against leakage. See "14. CAUTION FOR REFRIGERANT LEAKS" for details.

4. INSPECTING AND HANDLING THE UNIT

- At delivery, the package should be checked and any damage should be reported immediately to the carrier claims agent.
 - When handling the unit, take into account the following:
- Fragile, handle the unit with care.
 Keep the unit upright in order to avoid compressor damage.
 - Decide on the transportation route.
 - If a forklift is to be used, pass the forklift arms through the large openings on the bottom of the unit. (Refer to figure 5)
 - If hanging the unit, use a cloth sling to prevent damaging the unit. Keeping the following points in mind, hang the unit following the procedure shown in figure 6.
 - Use a sling sufficiently strong to hold the mass of the unit.
 - Use 2 belts of at least 8m long.
 - Place extra cloth or boards in the locations where the casing comes in contact with the sling to prevent damage.
 - Hoist the unit making sure it is being lifted at its center of gravity.
 - After installation, remove the transportation clasp attached to the large openings. (Refer to figure 6)
 - If carrying baggage the unit, hold hand top rear handle product and basic front lower leg product, carry as shown in figure 7.
 - Because the equipment break, the product do not slant than 60 degree.
 - Regularly wear glove to work.
 - Obey local law about work method, and work more than 4 persons.

(Refer to figure 5)

- Fork
- Hole (large)
- Transportation clasp (yellow)
- Fixed screws of transportation clasp

(Refer to figure 6)

- Belt sling
- Board
- Hole (large)

(Refer to figure 7)

- Cushion plate
- Foundation leg
- Hanger

Note

Apply a filler cloth on a fork to prevent coating of the bottom frame from coming off and rust from occurring when bringing in the unit with anti-corrosion treatment type using a forklift.

5. PLACING THE UNIT

- Make sure the unit is installed level on a sufficiently strong base to prevent vibration and noise. (Refer to figure 8)
- The base should be bigger around than the width of the unit's legs (66 mm), and should support the unit. (Refer to figure 9)
If protective rubber is to be attached, attach it to the whole face of the base.
- The height of the base should be at least 150mm from the floor.
- Secure the unit to its base using foundation bolts. (Use four commercially available M12-type foundation bolts, nuts, and washers.)
- The foundation bolts should be inserted 20 mm.

(Refer to figure 8)

- The product can be supported with four corners

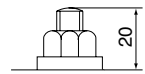

(Refer to figure 9)

- Foundation bolt point (φ15 dia. : 4 positions)
- Depth of product

Note

- There are restrictions on the refrigerant pipe connecting order between outdoor unit in the case of the multi system. See the Note in "2-1 Combination" for detail.
- When installing on a roof, make sure the roof floor is strong enough and be sure to water-proof all work.
- Make sure the area around the machine drains properly by setting up drainage grooves around the foundation. Drain water is sometimes discharged from the outdoor unit when it is running.
- For anti-corrosion type use nuts with resin washers. If the paint on nut connections comes off, the anti-corrosion effect may decrease.

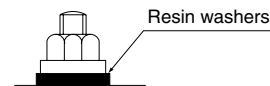

6. REFRIGERANT PIPING

Note

- All field piping must be installed by a licensed refrigeration technician and must comply with relevant local and national regulations.
- After piping work is complete, do not under any circumstances open the shutoff valve until "7. FIELD WIRING" and "10. CHECKING OF DEVICE AND INSTALLATION CONDITIONS" are complete.
- Do not use flux when brazing the refrigerant piping. Use the phosphor copper brazing filler metal (BCuP-2: JIS Z 3264/B-Cu93P-710/795: ISO 3677) which does not require flux. (Flux has extremely harmful influence on refrigerant piping systems. For instance, if chlorine based flux is used, it will cause pipe corrosion or, in particular, if the flux contains fluorine, it will damage the refrigerant oil.)

6-1 Selection of piping material and Refrigerant branching kit

- Use only pipes which are clean inside and outside and do not accumulate harmful sulfur, oxidants, dirt, cutting oils, moisture, or other contamination. (Foreign materials inside pipes including oils for fabrication must be 30mg/10m or less.)

- Use the following items for the refrigerant piping.
 - Material:** Jointless phosphor-deoxidized copper pipe.
 - Size:** See "6-5 Example of connection" to determine the correct size.
 - Thickness:** Select a thickness for the refrigerant piping which complies with national and local laws.
- Refrigerant pipe (Gas pipe and Liquid pipe) and refrigerant branch must meet the condition of design pressure 3.3MPa. If it is not possible to confirm, use the refrigerant branch kit selected with 6-5 Example of connection. Existing pipes must meet the condition of design pressure 3.3MPa. Specifically, to confirm that there are no corrosion and the pipe thickness must not be less than the smallest thickness below. Temper grade (O type, 1/2H type) in the table indicate the material types specified in JIS H 3300.

(unit: mm)

Temper grade	O type				
outer diameter	φ6.4	φ9.5	φ12.7	φ15.9	φ19.1
smallest thickness	0.4*	0.5*	0.7*	0.9*	1.0*

* In case of bending 3xD or more (D: O.D. of refrigerant pipe)

(unit: mm)

Temper grade	1/2H type							
outer diameter	φ19.1	φ22.2	φ25.4	φ28.6	φ31.8	φ34.9	φ38.1	φ41.3
smallest thickness	0.6	0.6	0.7	0.8	0.9	1.0	1.1	1.1

- For piping work, follow the maximum tolerated length, difference in height, and length after a branch indicated in the "6-5 Example of connection".
- A refrigerant branching kit (sold separately) is needed for piping branches and connection of piping between outdoor unit (in case of multi system). Use only separately sold items selected specifically according to the refrigerant branch kit selection in the "6-5 Example of connection".
- If any tapered pipes are used as branching pipes, replace them.
- If the diameter of existing piping differs from that of outdoor/BS/indoor units, use a locally-procured irregular socket.

6-2 Protection against contamination when installing pipes

Protect the piping to prevent moisture, dirt, dust, etc. from entering the piping.

Place	Installation period	Protection method
Outdoor	More than a month	Pinch the pipe
	Less than a month	Pinch or tape the pipe
Indoor	Regardless of the period	

Note

Exercise special caution to prevent dirt or dust when passing piping through holes in walls and when passing pipe edges to the exterior.

6-3 Pipe connection

- Be sure to perform nitrogen permutation or nitrogen blow when brazing. (Refer to figure 11)

Brazing without performing nitrogen permutation or nitrogen blow into the piping will create large quantities of oxidized film on the inside of the pipes, adversely affecting valves and compressors in the refrigerating system and preventing normal operation.

(Refer to figure 11)

 - Refrigerant pipe
 - Location to be brazed
 - Nitrogen
 - Taping
 - Handy valve
 - Regulator
- The pressure regulator for the nitrogen released when doing the brazing should be set to 0.02 MPa (about 0.2kg/cm²). Enough to feel a slight breeze on your cheek).

Note

Do not use anti-oxidants when brazing the pipe joints. Residue can clog pipes and break equipment.

6-4 Connecting the refrigerant piping

- Direction to bring out the pipes

The local interunit piping can be connected either forward or to the sides (taken out through the bottom) as shown in the figure 12. (When passing out through the bottom, use the knock hole in the bottom frame.)

(Refer to figure 12)

 - Left-side connection
 - Front connection
 - Right-side connection

Precautions when knocking out knock holes.

- Open knock hole in the base frame by drilling the 4 concave around it with a 6mm bit. (Refer to figure 13)

(Refer to figure 13)

 - Knock hole
 - Drill
 - Concave section
 - Be sure to avoid damaging the casing.
 - After knocking out the holes, we recommend you remove any burrs and paint them using the repair paint to prevent rusting.
 - When passing electrical wiring through the knock holes, protect the wiring with a conduit or bushings, making sure not to damage the wiring.
- Removing Pinch Piping

CAUTION

Never remove the pinched piping by brazing.

Any gas or oil remaining inside the stop valve may blow off the pinched piping.

Failure to observe the instructions in procedure below properly may result in property damage or personal injury, which may be serious depending on the circumstances.

- When connecting refrigerant piping to an outdoor unit, remove the pinch piping.
- Pinch piping should be removed using the procedure below.
- Heat Pump series (RQ(C)YQ) (Refer to figure 14.1)
 - Pinch piping (2 pipings)
 - Pinching is not used

<Procedure>

- Confirm the shutoff valve is closed.
- Connect a charge hose to the service port on the liquid side and suction gas side shutoff valves and remove the gas from the pinch piping.
- Cut the pinched piping off with a pipe cutter just above the marking.

CAUTION

Never remove the pinched piping by brazing.



- Wait until all oil is dripped out in case the recovery was not complete, and only then proceed with connection of the field piping.
- Heat Recovery series (RQCEQ) (Refer to figure 14.2)
 - Pinch piping (3 pipings)

<Procedure>

- Confirm the shutoff valve is closed.
- Connect a charge hose to the service port on the liquid side, suction gas side and HP/LP gas side shutoff valves and remove the gas from the pinch piping.
- Cut the pinched piping off with a pipe cutter just above the marking.

CAUTION

Never remove the pinched piping by brazing.



- Wait until all oil is dripped out in case the recovery was not complete, and only then proceed with connection of the field piping.

Note 

(Refer to figure 14.3)

1. Service port
2. Valve cover
3. Open
4. Close
5. Piping onsite
6. Cutoff line
7. Pinch piping

3. Connecting refrigerant piping to outdoor units

<In case of single system>

- Heat Pump series (RQYQ) (Refer to figure 15.1)
 1. When connected to the front side
 2. When connected to the lateral side (bottom)
 3. Remove the shutoff valve cover to connect
 4. Remove the knock hole on the bottom frame and route the piping under the bottom frame
 5. Liquid side shutoff valve
 6. Gas side shutoff valve
 7. Liquid side accessory pipe (1)
 8. Liquid side accessory pipe (2)
 9. Gas side accessory pipe (1)
 10. Gas side accessory pipe (2)
 11. L type accessory joint
 12. Brazing
 13. Piping is not used
- Heat Recovery series (RQEQ) (Refer to figure 15.2)
 1. When connected to the front side
 2. When connected to the lateral side (bottom)
 3. Remove the shutoff valve cover to connect
 4. Remove the knock hole on the bottom frame and route the piping under the bottom frame
 5. Liquid side shutoff valve
 6. Suction gas side shutoff valve
 7. HP/LP gas side shutoff valve
 8. Liquid side accessory pipe (1)
 9. Liquid side accessory pipe (2)
 10. Suction gas side accessory pipe (1)
 11. Suction gas side accessory pipe (2)
 12. HP/LP gas side accessory pipe (1)
 13. HP/LP gas side accessory pipe (2)
 14. L type accessory joint
 15. Brazing

Note 

<Connecting Refrigerant Piping>

- When connecting the piping on site, be sure to use the accessory piping.
- Make sure the onsite piping does not come into contact with other piping or the bottom frame or side panels of the unit.

<Multi Systems>

- RQEQ series cannot be used as an independent unit in a multi system.
 - The Outdoor unit multi connection piping kit (sold separately) is needed when connecting piping between outdoor units. Refer to the installation manual that comes with the kit when doing this piping work.
- 4. Precautions when connecting piping between outdoor units (In case of multi system)**
- The Outdoor unit multi connection piping kit (sold separately) is needed to connect piping between outdoor units in multi system. Only proceed with piping work after considering the limitations on installation listed here and in "5. Branching the refrigerant piping", always referring to the kit's installation manual.
- (1) The piping between outdoor units must be installed level (Pattern 1) or with a rise (Pattern 2). Otherwise, oil may pool in the pipes.

O: Possible, X: Impossible

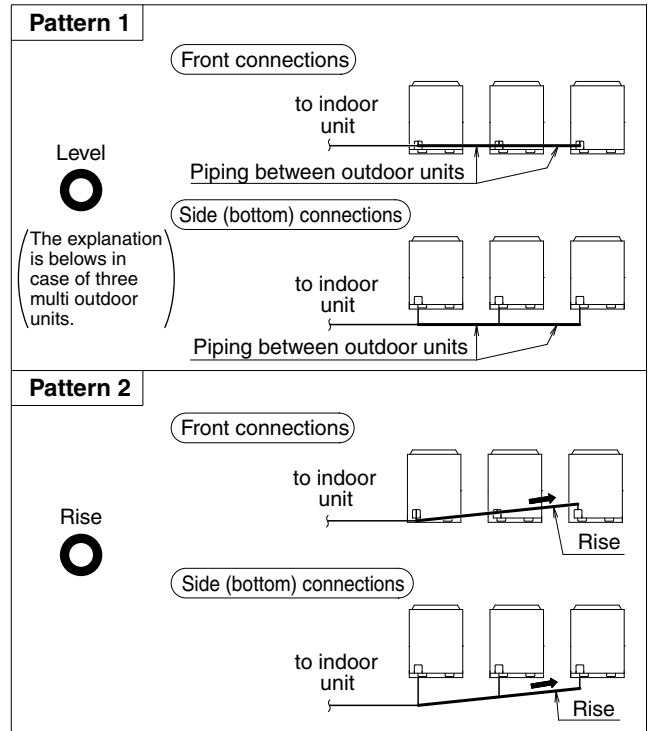

 Change to pattern 1 or pattern 2

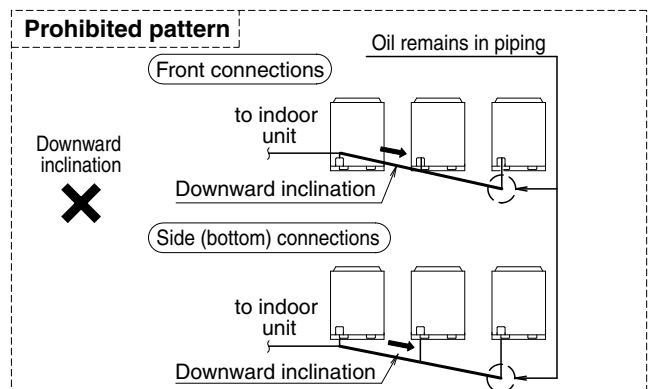

- (2) To avoid the risk of oil retention in the stopping unit, always connect the shutoff valve and the piping between outdoor units as shown in the figure A or figure B.

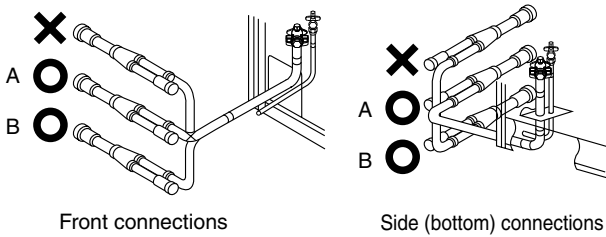

Prohibited pattern

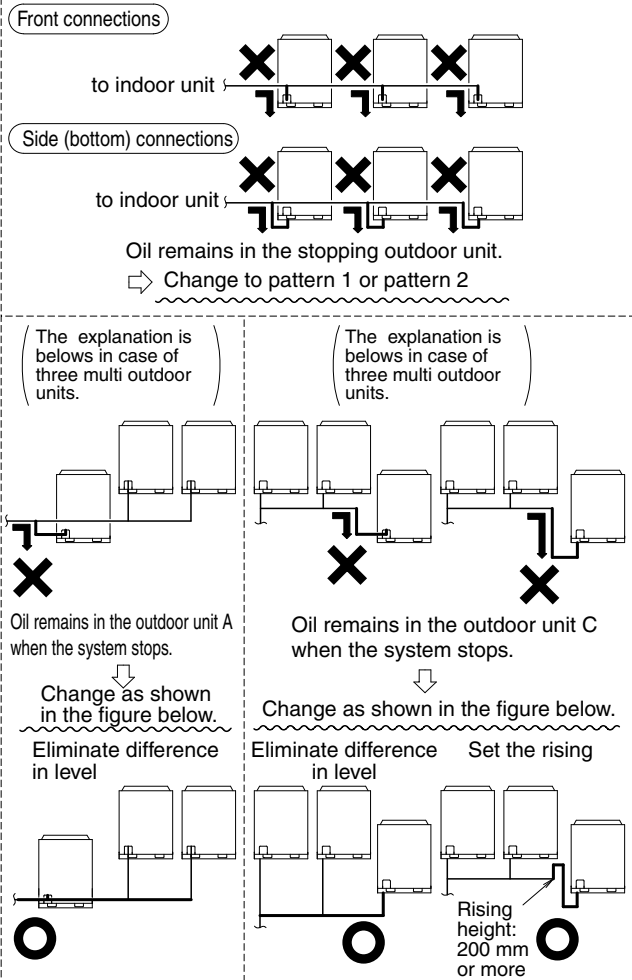

- (3) If the piping length between the outdoor units exceeds 2 m, create a rise of 200 mm or more in the gas line under a length of 2 m from the outdoor unit multi connection piping kit.

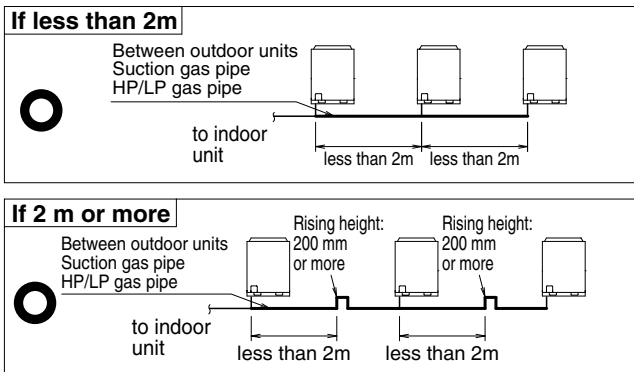

5. Branching the refrigerant piping
- Heed the restrictions below when installing the refrigerant branching kit and read the installation instruction manual with the kit. (Improper installation could lead to malfunctioning or breakdown of the outdoor unit.)

<REFNET joint>

Install the REFNET joint so it splits horizontally or vertically.

(Refer to figure 16)

1. Horizontal surface
2. $\pm 30^\circ$ or less
3. Horizontal
4. Vertical

<REFNET header>

Install the REFNET header so it splits horizontally.

(Refer to figure 17)

1. Horizontal surface

<Outdoor unit multi connection piping kit>

- Install the joint horizontally so that the attached warning label faces straight up, and the tilt is within $\pm 15^\circ$. (Refer to figure 18-1) Do not install vertically. (Refer to figure 18-2)
- Maintain a straight portion of 500 mm or more until the split of the joint without wrapping any onsite piping around this area. Over 500 mm of straight area can be maintained by connecting at least 120 mm of onsite pipe (straight) to the joint.

(Refer to figure 18-3)

(Refer to figure 18)

1. Warning label
2. Horizontal surface
3. $\pm 15^\circ$ or less
4. Ground
5. Onsite pipe (120mm length or more)
6. Straight part of 500mm or more

6-5 Example of connection

■ Heat Pump series (RQ(C)YQ)

Example of connection (Connection of 8 indoor units)	Example refrigerant branch using REFNET joint	Example refrigerant branch using REFNET joint and REFNET header	Example refrigerant branch using REFNET header
<p>(*) -> indicate the Outdoor unit multi connection piping kit.</p> <p>(**) In case of multi outdoor system, re-read to the first Outdoor unit multi connection piping kit as seen from the indoor unit.</p>	<p>Single outdoor system</p>	<p>Multi outdoor system</p>	<p>REFNET header</p>
<p>Maximum allowable length</p> <p>Between outdoor (r2) and indoor units</p> <p>Between outdoor unit and Outdoor unit multi connection piping kit (Only for multi system)</p> <p>Between outdoor and indoor units</p> <p>Between indoor and indoor units</p> <p>Between outdoor and outdoor units</p> <p>Allowable length after the branch</p>	<p>Pipe length between outdoor (r2) and indoor units $\leq 120m$</p> <p>Example unit [8]: a + b + c + d + e + f + g + p $\leq 120m$</p> <p>Equivalent pipe length between outdoor (r2) and indoor units $\leq 150m$ (assume equivalent pipe length of REFNET joint to be 0.5m, that of REFNET header to be 1m, calculation purposes) (See Note 1 - Next page)</p> <p>Total pipe length from outdoor unit (r2) to all indoor units $\leq 300m$</p>	<p>Pipe length between outdoor unit and outdoor unit multi connection piping kit $\leq 13m$</p> <p>Example unit [8]: a + b + h $\leq 165m$, unit [8]: a + i + k $\leq 120m$</p>	<p>Example unit [8]: a + i + k $\leq 40m$</p>
<p>Allowable height of piping kit length</p> <p>Between indoor and outdoor units</p> <p>Between outdoor and outdoor units</p> <p>Allowable length after the branch</p>	<p>First Outdoor unit multi connection piping kit</p> <p>REFNET joint (A-G)</p> <p>REFNET joint (A+B)</p> <p>REFNET header</p> <p>Indoor units (1)-(8)</p> <p>Indoor units (1)-(8)</p>	<p>REFNET joint (A+B)</p> <p>REFNET header</p> <p>Indoor units (1)-(8)</p> <p>Indoor units (1)-(8)</p>	<p>Indoor unit</p> <p>Outdoor unit</p> <p>REFNET header</p> <p>Indoor units (1)-(8)</p> <p>Indoor units (1)-(8)</p>
<p>Refrigerant branch kit selection</p> <p>Refrigerant branch kits can only be used with R410A.</p> <p>When multi outdoor system are installed, be sure to use the special separately sold Outdoor unit multi connection piping kit.</p> <p>The table at right shows how to select the proper kit.</p>	<p>How to select the REFNET joint</p> <ul style="list-style-type: none"> Choose from the following table in accordance with the outdoor unit side. When using REFNET joint at the first branch counted from the outdoor unit side. Choose from the following table in accordance with the outdoor unit capacity type. (Example: REFNET joint A) 	<p>How to select the REFNET header</p> <ul style="list-style-type: none"> Choose from the following table in accordance with the total capacity index of all the indoor units connected below the REFNET header. Note: 250 type indoor unit cannot be connected below the REFNET header. 	<p>How to select the Outdoor unit multi connection piping kit. (This is required when the system is multi outdoor unit system).</p> <ul style="list-style-type: none"> Choose from the following table in accordance with the number of outdoor units.
<p>Outdoor unit capacity type</p> <p>Q140-180 type</p> <p>Q280 type</p> <p>Q360-540 type</p>	<p>Refrigerant branch kit name</p> <p>KHRP26A22T</p> <p>KHRP26A33T</p> <p>KHRP26A72T</p>	<p>Indoor unit total capacity index</p> <p>< 200</p> <p>200 \leq X < 290</p> <p>290 \leq X < 640</p> <p>640 \leq</p>	<p>Refrigerant branch kit name</p> <p>KHRP26M33H</p> <p>KHRP26M33H</p> <p>KHRP26M72H</p> <p>KHRP26M73H + KHRP26M73HP</p>
<p>Number of outdoor units</p> <p>2 units</p> <p>3 units</p>	<p>Connection piping kit name</p> <p>BHFP22P36C</p> <p>BHFP22P54C</p>	<p>Example REFNET joint C: indoor units [3]+[4]+[5]+[6]+[7]+[8]</p> <p>Example REFNET joint B: indoor units [2]+[3]+[4]+[5]+[6]</p> <p>Example REFNET header: indoor units [1]+[2]+[3]+[4]+[5]+[6]</p>	<p>Example REFNET header: indoor units [1]+[2]+[3]+[4]+[5]+[6]+[7]+[8]</p>

Pipe size selection

△ Caution
Refer to the diagram below and select the appropriate piping from the tables on the right.

<Single Outdoor Unit System>

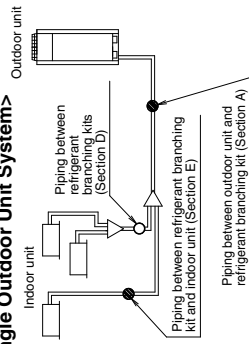

<Multiple Outdoor Unit System>

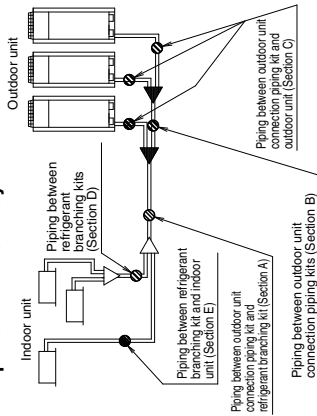

Piping between outdoor unit (*2) and refrigerant branch kit (part A).
 • Choose from the following table in accordance with the outdoor unit system capacity type. (Note1)

Outdoor capacity index	Suction gas size		Liquid pipe	
	Standard size	Maximum size	Standard size	Maximum size
Q140	φ15.9	φ25.4	φ9.5	φ12.7
Q180	φ19.1	φ28.6	φ12.7	φ15.9
Q280	φ22.2	φ28.6	φ12.7	φ15.9
Q360	φ25.4	φ41.3	φ15.9	φ19.1
Q460	φ28.6	φ41.3	φ15.9	φ19.1
Q500	φ28.6	φ41.3	φ15.9	φ19.1
Q540	φ28.6	φ41.3	φ15.9	φ19.1

Piping between outdoor unit multi connection piping kits (part B).
 • Choose from the following table in accordance with the total capacity of all the outdoor units connected upstream.

Outdoor unit capacity type	Suction gas pipe		Liquid pipe	
	Standard size	Maximum size	Standard size	Maximum size
280	φ22.2	φ25.4	φ9.5	φ12.7
360	φ22.2	φ25.4	φ9.5	φ12.7

Piping between outdoor unit multi connection piping kit and outdoor unit (part C).
 • Choose from the following table in accordance with the capacity type of the outdoor unit connected.

Outdoor capacity index	Gas pipe		Liquid pipe	
	Standard size	Maximum size	Standard size	Maximum size
Q140	φ15.9	φ19.1	φ9.5	φ9.5
Q180	φ15.9	φ19.1	φ9.5	φ9.5

Piping between refrigerant branch kits.

- Choose from the following table in accordance with the total capacity index of all the indoor units connected below this (part D).
- Do not let the connection piping exceed the main refrigerant piping size.

Indoor capacity index	Suction gas pipe		Liquid pipe	
	Standard size	Maximum size	Standard size	Maximum size
< 11.2 kW	φ15.9	φ19.1	φ9.5	φ12.7
11.2 kW ≤ x < 22.4 kW	φ15.9	φ25.4	φ9.5	φ12.7
22.4 kW ≤ x < 33.0 kW	φ22.2	φ25.4	φ12.7	φ15.9
33.0 kW ≤ x < 37.0 kW	φ25.4	φ28.6	φ12.7	φ15.9
37.0 kW ≤ x < 47.0 kW	φ28.6	φ34.9	φ15.9	φ19.1
47.0 kW ≤ x < 71.0 kW	φ34.9	φ41.3	φ15.9	φ19.1
71.0 kW ≤	φ34.9	φ41.3	φ15.9	φ19.1

Piping between refrigerant branch kit and indoor unit.

- Match to the size of the connection piping on the indoor unit (part E).

Indoor capacity index	Suction gas pipe		Liquid pipe	
	Standard size	Maximum size	Standard size	Maximum size
Q20	φ12.7	φ15.9	φ6.4	φ9.5
Q25	φ12.7	φ15.9	φ6.4	φ9.5
Q32	φ12.7	φ15.9	φ6.4	φ9.5
Q40	φ12.7	φ15.9	φ6.4	φ9.5
Q50	φ12.7	φ15.9	φ6.4	φ9.5
Q63	φ12.7	φ15.9	φ6.4	φ9.5
Q80	φ15.9	φ19.1	φ9.5	φ12.7
Q100	φ15.9	φ19.1	φ9.5	φ12.7
Q125	φ15.9	φ19.1	φ9.5	φ12.7
Q200	φ19.1	φ28.6	φ9.5	φ15.9
Q250	φ22.2	φ28.6	φ9.5	φ15.9

How to calculate the additional refrigerant to be charged.

Additional refrigerant to be charged R (kg) (R should be rounded off in units of 0.1kg.)

$$R = \left(\frac{\text{Total length (m) of liquid piping (size at } \phi 19.1)}{\times 0.26} \right) \text{ kg/m} + \left(\frac{\text{Total length (m) of liquid piping (size at } \phi 15.9)}{\times 0.18} \right) \text{ kg/m} + \left(\frac{\text{Total length (m) of liquid piping (size at } \phi 12.7)}{\times 0.12} \right) \text{ kg/m}$$

$$+ \left(\frac{\text{Total length (m) of liquid piping (size at } \phi 9.5)}{\times 0.059} \right) \text{ kg/m} + \left(\frac{\text{Total length (m) of liquid piping (size at } \phi 6.4)}{\times 0.022} \right) \text{ kg/m}$$

$$+ \left(\frac{\text{Total length (m) of liquid piping (size at } \phi 12.7)}{\times 0.12} \right) \text{ kg/m}$$

RQYQ140	2.4 kg	RQCYQ460	11.2 kg
RQYQ180	2.4 kg	RQCYQ500	11.2 kg
RQCYQ280	6.8 kg	RQCYQ540	11.2 kg
RQCYQ360	6.8 kg		

+

A ≤ 100%	0 kg
A > 100%	0.5 kg

(A: The ratio of total capacity index of connectable indoor units to outdoor capacity index (%).)

Example for refrigerant branch using REFNET joint and REFNET header

In case the outdoor unit is RQCYQ540PY1 type and the piping lengths are as at right.

a: φ15.9 × 30m	d: φ9.5 × 20m	g: φ9.5 × 20m	j: φ6.4 × 10m	s: φ9.5 × 1m
b: φ15.9 × 10m	e: φ9.5 × 20m	h: φ9.5 × 20m	k: φ6.4 × 10m	t: φ9.5 × 1m
c: φ9.5 × 20m	f: φ9.5 × 20m	i: φ9.5 × 10m	r: φ9.5 × 1m	u: φ12.7 × 3m

Total capacity of indoor unit: 116%

$$R = \left(\frac{40 \times 0.18}{a, b} + \frac{3 \times 0.12}{u} + \frac{1.33 \times 0.059}{c-i, r-t} + \frac{20 \times 0.022}{j, k} - \frac{1.2}{RQCYQ540PY1} + \frac{0.5}{116\%} \right) = 5.147 \rightarrow 5.1 \text{ kg}$$

***Note 1**

When the equivalent pipe length between outdoor unit multi connection piping kit and indoor units is 90m or more, the size of main pipes (both gas-side and liquid-side) must be increased to the following table.

Depending on the length of the piping, the capacity may drop, but even in such case it is able to increase the size of main pipes.

(Refer to figure 10.1)

1. Outdoor unit
2. Main pipes
3. Increase
4. The first refrigerant branch kit
5. Indoor unit

Model name of outdoor unit system	Piping size (O.D.)	
	Gas pipe	Liquid pipe
RQYQ140	φ15.9 → φ19.1	φ9.5 → Not increased
RQYQ180	φ19.1 → φ22.2	φ9.5 → Not increased
RQCYQ280	φ22.2 → φ25.4	φ9.5 → φ12.7
RQCYQ360	φ25.4 → φ28.6	φ12.7 → φ15.9
RQCYQ460	φ28.6 → φ34.9	
RQCYQ500, 540		φ15.9 → φ19.1

■ Heat Recovery series (RQ(C)EQ)

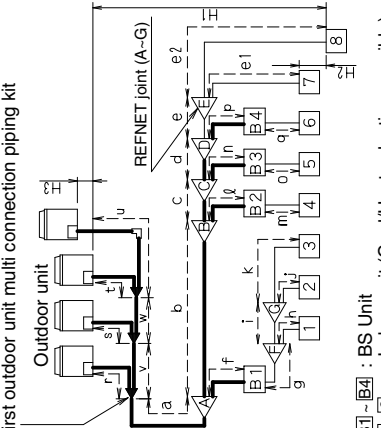
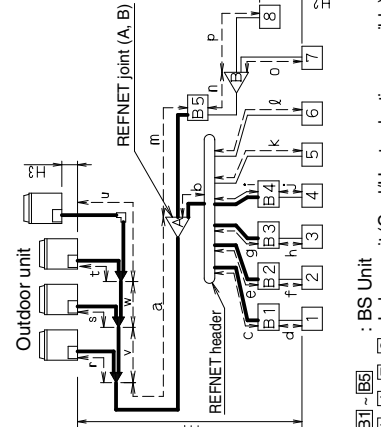
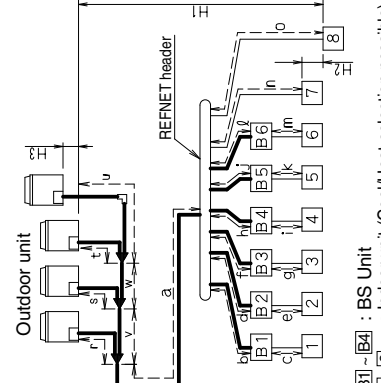
<p>Example of connection (Connection of 8 indoor units)</p> <p>Outdoor unit (1) — BS Unit (2) Indoor unit side</p> <p>① Piping from outdoor unit to BS unit</p> <ul style="list-style-type: none"> (Bold): 3 pipes { Suction gas pipe, HP/LP gas pipe, Liquid pipe } Piping from BS unit to indoor unit or indoor unit used as cooling only (Thin): 2 pipes { (Suction) gas pipe, Liquid pipe } <p>(*) "←" Indicate the Outdoor unit multi connection piping kit</p> <p>(*) In case of multi outdoor system, re-read "outdoor unit" to "the first Outdoor unit multi connection piping kit" as seen from the indoor unit.</p>	<p>Multi outdoor system (ROCEQ)</p>	<p>Branch with REFNET joint</p> <p>First outdoor unit multi connection piping kit</p>  <p>BS Unit (B1) - (B4) Indoor unit (Cool/Heat selection possible) (1) - (6) Indoor unit (Cooling only) (7), (8)</p>	<p>Branch with REFNET joint and header</p>  <p>BS Unit (B1) - (B5) Indoor unit (Cool/Heat selection possible) (1) - (4), (7), (8) Indoor unit (Cooling only) (5), (6)</p>	<p>Branch with REFNET header</p>  <p>BS Unit (B1) - (B4) Indoor unit (Cool/Heat selection possible) (1) - (6) Indoor unit (Cooling only) (7), (8)</p>																																																																								
<p>Actual pipe length</p> <p>Example (6) : $a + b + c + d + e + s \leq 120m$ Example (8) : $a + m + n + p \leq 120m$ Example (9) : $a + o \leq 120m$</p> <p>Equivalent length</p> <p>Equivalent pipe length between outdoor unit (*) and indoor unit $\leq 150m$ (Note 1) (Assume equivalent pipe length of REFNET joint to be 0.5m, that of REFNET header to be 1m, that of BS/VQ100-160, BSQ100-160, and BS1Q10-16 to be 4m, that of BSVQ250, BSQ250, and BSTQ25 to be 6m for calculation purposes.) (In case of BSV4Q100PV1 and BSV6Q100PV1 (combined type BS unit), calculate at 4m per 1 unit.) (In case of BS4Q14AV1 and BS6Q14AV1 (combined type BS unit), calculate at 6m per 1 unit.) (In case of BS8-10-12-16Q14AV1 (combined type BS unit), calculate at 10m per 1 unit.)</p> <p>Total extension length</p> <p>Total piping length from outdoor unit (*) to all indoor unit $\leq 300m$</p> <p>Actual and Equivalent pipe length</p> <p>Actual pipe length from first outdoor unit multi connection piping kit to outdoor unit $\leq 10m$ Equivalent pipe length from first outdoor unit multi connection piping kit to outdoor unit $\leq 13m$</p>	<p>Actual pipe length</p> <p>Example (6) : $b + c + d + e + s \leq 40m$ Example (8) : $b + l \leq 40m, 8, m + n + p \leq 40m$ Example (9) : $o \leq 40m$</p> <p>How to select the REFNET joint</p> <ul style="list-style-type: none"> When using REFNET joint at the first branch counted from the outdoor unit side, choose from the following table in accordance with the outdoor unit capacity type. (Example : REFNET joint A) <table border="1" data-bbox="1085 806 1212 1456"> <tr> <th>Outdoor unit capacity type</th> <th>Refrigerant branch kit name</th> </tr> <tr> <td>Q280 type</td> <td>KHRP25A33T</td> </tr> <tr> <td>Q360~712 type</td> <td>KHRP25A72T+KHRP25M72TP</td> </tr> <tr> <td>Q744 type ~</td> <td>KHRP25A73T+KHRP25M73TP</td> </tr> </table> <ul style="list-style-type: none"> Choose the REFNET joints other than the first branch from the following table in accordance with the total capacity index of all the indoor units connected below the REFNET joint. <table border="1" data-bbox="1212 806 1340 1456"> <tr> <th>Indoor unit total capacity index</th> <th>Refrigerant branch kit name</th> </tr> <tr> <td>$x < 200$</td> <td>KHRP25A22T</td> </tr> <tr> <td>$200 \leq x < 290$</td> <td>KHRP25A33T</td> </tr> <tr> <td>$290 \leq x < 640$</td> <td>KHRP25A72T+KHRP25M72TP</td> </tr> <tr> <td>$640 \leq x$</td> <td>KHRP25A73T+KHRP25M73TP</td> </tr> </table>	Outdoor unit capacity type	Refrigerant branch kit name	Q280 type	KHRP25A33T	Q360~712 type	KHRP25A72T+KHRP25M72TP	Q744 type ~	KHRP25A73T+KHRP25M73TP	Indoor unit total capacity index	Refrigerant branch kit name	$x < 200$	KHRP25A22T	$200 \leq x < 290$	KHRP25A33T	$290 \leq x < 640$	KHRP25A72T+KHRP25M72TP	$640 \leq x$	KHRP25A73T+KHRP25M73TP	<p>Actual pipe length</p> <p>Example (6) : $b + c + d + e + s \leq 40m$ Example (8) : $b + l \leq 40m, 8, m + n + p \leq 40m$ Example (9) : $o \leq 40m$</p> <p>How to select the REFNET header</p> <ul style="list-style-type: none"> Choose from the following table in accordance with the total capacity index of all the indoor units connected below the REFNET header. 250 type indoor unit can not be connected below the REFNET header. <table border="1" data-bbox="1085 134 1212 515"> <tr> <th>Indoor unit total capacity index</th> <th>Refrigerant branch kit name</th> </tr> <tr> <td>$x < 200$</td> <td>KHRP26M22H or KHRP26M33H</td> </tr> <tr> <td>$200 \leq x < 290$</td> <td>KHRP26M33H</td> </tr> <tr> <td>$290 \leq x < 640$</td> <td>KHRP26M72H+KHRP26M72HP</td> </tr> <tr> <td>$640 \leq x$</td> <td>KHRP26M73H+KHRP26M73HP</td> </tr> </table> <p>How to select the outdoor unit multi connection piping kit</p> <p>(This is required when the system is multi outdoor unit system.)</p> <ul style="list-style-type: none"> Choose from the following table in accordance with the number of outdoor units. <table border="1" data-bbox="1212 134 1340 515"> <tr> <th>Number of outdoor unit</th> <th>Connecting piping kit name</th> </tr> <tr> <td>2 units</td> <td>BHFP26P36C</td> </tr> <tr> <td>3 units</td> <td>BHFP26P63C</td> </tr> <tr> <td>4 units</td> <td>BHFP26P84C</td> </tr> </table>	Indoor unit total capacity index	Refrigerant branch kit name	$x < 200$	KHRP26M22H or KHRP26M33H	$200 \leq x < 290$	KHRP26M33H	$290 \leq x < 640$	KHRP26M72H+KHRP26M72HP	$640 \leq x$	KHRP26M73H+KHRP26M73HP	Number of outdoor unit	Connecting piping kit name	2 units	BHFP26P36C	3 units	BHFP26P63C	4 units	BHFP26P84C	<p>Actual pipe length</p> <p>Example (6) : $b + c + d + e + s \leq 40m$ Example (8) : $b + l \leq 40m, 8, m + n + p \leq 40m$ Example (9) : $o \leq 40m$</p> <p>How to select the REFNET joint</p> <ul style="list-style-type: none"> When using REFNET joint at the first branch counted from the outdoor unit side, choose from the following table in accordance with the outdoor unit capacity type. (Example : REFNET joint A) <table border="1" data-bbox="1085 806 1212 1456"> <tr> <th>Outdoor unit capacity type</th> <th>Refrigerant branch kit name</th> </tr> <tr> <td>Q280 type</td> <td>KHRP25A33T</td> </tr> <tr> <td>Q360~712 type</td> <td>KHRP25A72T+KHRP25M72TP</td> </tr> <tr> <td>Q744 type ~</td> <td>KHRP25A73T+KHRP25M73TP</td> </tr> </table> <ul style="list-style-type: none"> Choose the REFNET joints other than the first branch from the following table in accordance with the total capacity index of all the indoor units connected below the REFNET joint. <table border="1" data-bbox="1212 806 1340 1456"> <tr> <th>Indoor unit total capacity index</th> <th>Refrigerant branch kit name</th> </tr> <tr> <td>$x < 200$</td> <td>KHRP26A22T</td> </tr> <tr> <td>$200 \leq x < 290$</td> <td>KHRP26A33T</td> </tr> <tr> <td>$290 \leq x < 640$</td> <td>KHRP26A72T</td> </tr> <tr> <td>$640 \leq x$</td> <td>—</td> </tr> </table>	Outdoor unit capacity type	Refrigerant branch kit name	Q280 type	KHRP25A33T	Q360~712 type	KHRP25A72T+KHRP25M72TP	Q744 type ~	KHRP25A73T+KHRP25M73TP	Indoor unit total capacity index	Refrigerant branch kit name	$x < 200$	KHRP26A22T	$200 \leq x < 290$	KHRP26A33T	$290 \leq x < 640$	KHRP26A72T	$640 \leq x$	—	<p>Actual pipe length</p> <p>Example (6) : $b + c + d + e + s \leq 40m$ Example (8) : $b + l \leq 40m, 8, m + n + p \leq 40m$ Example (9) : $o \leq 40m$</p> <p>How to select the REFNET header</p> <ul style="list-style-type: none"> Choose from the following table in accordance with the total capacity index of all the indoor units connected below the REFNET header. 250 type indoor unit can not be connected below the REFNET header. <table border="1" data-bbox="1085 134 1212 515"> <tr> <th>Indoor unit total capacity index</th> <th>Refrigerant branch kit name</th> </tr> <tr> <td>$x < 200$</td> <td>KHRP26M22H or KHRP26M33H</td> </tr> <tr> <td>$200 \leq x < 290$</td> <td>KHRP26M33H</td> </tr> <tr> <td>$290 \leq x < 640$</td> <td>KHRP26M72H+KHRP26M72HP</td> </tr> <tr> <td>$640 \leq x$</td> <td>KHRP26M73H+KHRP26M73HP</td> </tr> </table> <p>How to select the outdoor unit multi connection piping kit</p> <p>(This is required when the system is multi outdoor unit system.)</p> <ul style="list-style-type: none"> Choose from the following table in accordance with the number of outdoor units. <table border="1" data-bbox="1212 134 1340 515"> <tr> <th>Number of outdoor unit</th> <th>Connecting piping kit name</th> </tr> <tr> <td>2 units</td> <td>BHFP26P36C</td> </tr> <tr> <td>3 units</td> <td>BHFP26P63C</td> </tr> <tr> <td>4 units</td> <td>BHFP26P84C</td> </tr> </table>	Indoor unit total capacity index	Refrigerant branch kit name	$x < 200$	KHRP26M22H or KHRP26M33H	$200 \leq x < 290$	KHRP26M33H	$290 \leq x < 640$	KHRP26M72H+KHRP26M72HP	$640 \leq x$	KHRP26M73H+KHRP26M73HP	Number of outdoor unit	Connecting piping kit name	2 units	BHFP26P36C	3 units	BHFP26P63C	4 units	BHFP26P84C
Outdoor unit capacity type	Refrigerant branch kit name																																																																											
Q280 type	KHRP25A33T																																																																											
Q360~712 type	KHRP25A72T+KHRP25M72TP																																																																											
Q744 type ~	KHRP25A73T+KHRP25M73TP																																																																											
Indoor unit total capacity index	Refrigerant branch kit name																																																																											
$x < 200$	KHRP25A22T																																																																											
$200 \leq x < 290$	KHRP25A33T																																																																											
$290 \leq x < 640$	KHRP25A72T+KHRP25M72TP																																																																											
$640 \leq x$	KHRP25A73T+KHRP25M73TP																																																																											
Indoor unit total capacity index	Refrigerant branch kit name																																																																											
$x < 200$	KHRP26M22H or KHRP26M33H																																																																											
$200 \leq x < 290$	KHRP26M33H																																																																											
$290 \leq x < 640$	KHRP26M72H+KHRP26M72HP																																																																											
$640 \leq x$	KHRP26M73H+KHRP26M73HP																																																																											
Number of outdoor unit	Connecting piping kit name																																																																											
2 units	BHFP26P36C																																																																											
3 units	BHFP26P63C																																																																											
4 units	BHFP26P84C																																																																											
Outdoor unit capacity type	Refrigerant branch kit name																																																																											
Q280 type	KHRP25A33T																																																																											
Q360~712 type	KHRP25A72T+KHRP25M72TP																																																																											
Q744 type ~	KHRP25A73T+KHRP25M73TP																																																																											
Indoor unit total capacity index	Refrigerant branch kit name																																																																											
$x < 200$	KHRP26A22T																																																																											
$200 \leq x < 290$	KHRP26A33T																																																																											
$290 \leq x < 640$	KHRP26A72T																																																																											
$640 \leq x$	—																																																																											
Indoor unit total capacity index	Refrigerant branch kit name																																																																											
$x < 200$	KHRP26M22H or KHRP26M33H																																																																											
$200 \leq x < 290$	KHRP26M33H																																																																											
$290 \leq x < 640$	KHRP26M72H+KHRP26M72HP																																																																											
$640 \leq x$	KHRP26M73H+KHRP26M73HP																																																																											
Number of outdoor unit	Connecting piping kit name																																																																											
2 units	BHFP26P36C																																																																											
3 units	BHFP26P63C																																																																											
4 units	BHFP26P84C																																																																											
<p>Allowable height difference</p> <p>Between outdoor and indoor units</p> <p>Between indoor and outdoor units</p> <p>Between outdoor and outdoor units</p> <p>Allowable length after the branch</p>	<p>Allowable height difference</p> <p>Between outdoor and indoor units (H1) $\leq 50m$ (Max 40m if the outdoor unit is below)</p> <p>Between indoor and outdoor units (H2) $\leq 15m$</p> <p>Between outdoor and outdoor units (H3) $\leq 5m$</p> <p>Actual pipe length</p> <p>Example (6) : $b + c + d + e + s \leq 40m$ Example (8) : $b + l \leq 40m, 8, m + n + p \leq 40m$ Example (9) : $o \leq 40m$</p> <p>How to select the REFNET joint</p> <ul style="list-style-type: none"> When using REFNET joint at the first branch counted from the outdoor unit side, choose from the following table in accordance with the outdoor unit capacity type. (Example : REFNET joint A) <table border="1" data-bbox="1085 806 1212 1456"> <tr> <th>Outdoor unit capacity type</th> <th>Refrigerant branch kit name</th> </tr> <tr> <td>Q280 type</td> <td>KHRP25A33T</td> </tr> <tr> <td>Q360~712 type</td> <td>KHRP25A72T+KHRP25M72TP</td> </tr> <tr> <td>Q744 type ~</td> <td>KHRP25A73T+KHRP25M73TP</td> </tr> </table> <ul style="list-style-type: none"> Choose the REFNET joints other than the first branch from the following table in accordance with the total capacity index of all the indoor units connected below the REFNET joint. <table border="1" data-bbox="1212 806 1340 1456"> <tr> <th>Indoor unit total capacity index</th> <th>Refrigerant branch kit name</th> </tr> <tr> <td>$x < 200$</td> <td>KHRP25A22T</td> </tr> <tr> <td>$200 \leq x < 290$</td> <td>KHRP25A33T</td> </tr> <tr> <td>$290 \leq x < 640$</td> <td>KHRP25A72T+KHRP25M72TP</td> </tr> <tr> <td>$640 \leq x$</td> <td>KHRP25A73T+KHRP25M73TP</td> </tr> </table>	Outdoor unit capacity type	Refrigerant branch kit name	Q280 type	KHRP25A33T	Q360~712 type	KHRP25A72T+KHRP25M72TP	Q744 type ~	KHRP25A73T+KHRP25M73TP	Indoor unit total capacity index	Refrigerant branch kit name	$x < 200$	KHRP25A22T	$200 \leq x < 290$	KHRP25A33T	$290 \leq x < 640$	KHRP25A72T+KHRP25M72TP	$640 \leq x$	KHRP25A73T+KHRP25M73TP	<p>Allowable height difference</p> <p>Between outdoor and indoor units (H1) $\leq 50m$ (Max 40m if the outdoor unit is below)</p> <p>Between indoor and outdoor units (H2) $\leq 15m$</p> <p>Between outdoor and outdoor units (H3) $\leq 5m$</p> <p>Actual pipe length</p> <p>Example (6) : $b + c + d + e + s \leq 40m$ Example (8) : $b + l \leq 40m, 8, m + n + p \leq 40m$ Example (9) : $o \leq 40m$</p> <p>How to select the REFNET joint</p> <ul style="list-style-type: none"> When using REFNET joint at the first branch counted from the outdoor unit side, choose from the following table in accordance with the outdoor unit capacity type. (Example : REFNET joint A) <table border="1" data-bbox="1085 806 1212 1456"> <tr> <th>Outdoor unit capacity type</th> <th>Refrigerant branch kit name</th> </tr> <tr> <td>Q280 type</td> <td>KHRP25A33T</td> </tr> <tr> <td>Q360~712 type</td> <td>KHRP25A72T+KHRP25M72TP</td> </tr> <tr> <td>Q744 type ~</td> <td>KHRP25A73T+KHRP25M73TP</td> </tr> </table> <ul style="list-style-type: none"> Choose the REFNET joints other than the first branch from the following table in accordance with the total capacity index of all the indoor units connected below the REFNET joint. <table border="1" data-bbox="1212 806 1340 1456"> <tr> <th>Indoor unit total capacity index</th> <th>Refrigerant branch kit name</th> </tr> <tr> <td>$x < 200$</td> <td>KHRP26A22T</td> </tr> <tr> <td>$200 \leq x < 290$</td> <td>KHRP26A33T</td> </tr> <tr> <td>$290 \leq x < 640$</td> <td>KHRP26A72T</td> </tr> <tr> <td>$640 \leq x$</td> <td>—</td> </tr> </table>	Outdoor unit capacity type	Refrigerant branch kit name	Q280 type	KHRP25A33T	Q360~712 type	KHRP25A72T+KHRP25M72TP	Q744 type ~	KHRP25A73T+KHRP25M73TP	Indoor unit total capacity index	Refrigerant branch kit name	$x < 200$	KHRP26A22T	$200 \leq x < 290$	KHRP26A33T	$290 \leq x < 640$	KHRP26A72T	$640 \leq x$	—	<p>Allowable height difference</p> <p>Between outdoor and indoor units (H1) $\leq 50m$ (Max 40m if the outdoor unit is below)</p> <p>Between indoor and outdoor units (H2) $\leq 15m$</p> <p>Between outdoor and outdoor units (H3) $\leq 5m$</p> <p>Actual pipe length</p> <p>Example (6) : $b + c + d + e + s \leq 40m$ Example (8) : $b + l \leq 40m, 8, m + n + p \leq 40m$ Example (9) : $o \leq 40m$</p> <p>How to select the REFNET header</p> <ul style="list-style-type: none"> Choose from the following table in accordance with the total capacity index of all the indoor units connected below the REFNET header. 250 type indoor unit can not be connected below the REFNET header. <table border="1" data-bbox="1085 134 1212 515"> <tr> <th>Indoor unit total capacity index</th> <th>Refrigerant branch kit name</th> </tr> <tr> <td>$x < 200$</td> <td>KHRP26M22H or KHRP26M33H</td> </tr> <tr> <td>$200 \leq x < 290$</td> <td>KHRP26M33H</td> </tr> <tr> <td>$290 \leq x < 640$</td> <td>KHRP26M72H+KHRP26M72HP</td> </tr> <tr> <td>$640 \leq x$</td> <td>KHRP26M73H+KHRP26M73HP</td> </tr> </table> <p>How to select the outdoor unit multi connection piping kit</p> <p>(This is required when the system is multi outdoor unit system.)</p> <ul style="list-style-type: none"> Choose from the following table in accordance with the number of outdoor units. <table border="1" data-bbox="1212 134 1340 515"> <tr> <th>Number of outdoor unit</th> <th>Connecting piping kit name</th> </tr> <tr> <td>2 units</td> <td>BHFP26P36C</td> </tr> <tr> <td>3 units</td> <td>BHFP26P63C</td> </tr> <tr> <td>4 units</td> <td>BHFP26P84C</td> </tr> </table>	Indoor unit total capacity index	Refrigerant branch kit name	$x < 200$	KHRP26M22H or KHRP26M33H	$200 \leq x < 290$	KHRP26M33H	$290 \leq x < 640$	KHRP26M72H+KHRP26M72HP	$640 \leq x$	KHRP26M73H+KHRP26M73HP	Number of outdoor unit	Connecting piping kit name	2 units	BHFP26P36C	3 units	BHFP26P63C	4 units	BHFP26P84C																			
Outdoor unit capacity type	Refrigerant branch kit name																																																																											
Q280 type	KHRP25A33T																																																																											
Q360~712 type	KHRP25A72T+KHRP25M72TP																																																																											
Q744 type ~	KHRP25A73T+KHRP25M73TP																																																																											
Indoor unit total capacity index	Refrigerant branch kit name																																																																											
$x < 200$	KHRP25A22T																																																																											
$200 \leq x < 290$	KHRP25A33T																																																																											
$290 \leq x < 640$	KHRP25A72T+KHRP25M72TP																																																																											
$640 \leq x$	KHRP25A73T+KHRP25M73TP																																																																											
Outdoor unit capacity type	Refrigerant branch kit name																																																																											
Q280 type	KHRP25A33T																																																																											
Q360~712 type	KHRP25A72T+KHRP25M72TP																																																																											
Q744 type ~	KHRP25A73T+KHRP25M73TP																																																																											
Indoor unit total capacity index	Refrigerant branch kit name																																																																											
$x < 200$	KHRP26A22T																																																																											
$200 \leq x < 290$	KHRP26A33T																																																																											
$290 \leq x < 640$	KHRP26A72T																																																																											
$640 \leq x$	—																																																																											
Indoor unit total capacity index	Refrigerant branch kit name																																																																											
$x < 200$	KHRP26M22H or KHRP26M33H																																																																											
$200 \leq x < 290$	KHRP26M33H																																																																											
$290 \leq x < 640$	KHRP26M72H+KHRP26M72HP																																																																											
$640 \leq x$	KHRP26M73H+KHRP26M73HP																																																																											
Number of outdoor unit	Connecting piping kit name																																																																											
2 units	BHFP26P36C																																																																											
3 units	BHFP26P63C																																																																											
4 units	BHFP26P84C																																																																											
<p>Refrigerant branch kit selection</p> <ul style="list-style-type: none"> Refrigerant branch kit must be used to prescribed kit. Use this table for kit selection. 	<p>Refrigerant branch kit selection</p> <ul style="list-style-type: none"> Refrigerant branch kit must be used to prescribed kit. Use this table for kit selection. 	<p>Refrigerant branch kit selection</p> <ul style="list-style-type: none"> Refrigerant branch kit must be used to prescribed kit. Use this table for kit selection. 	<p>Refrigerant branch kit selection</p> <ul style="list-style-type: none"> Refrigerant branch kit must be used to prescribed kit. Use this table for kit selection. 																																																																									
<p>Example for indoor units connected downstream</p>	<p>Example REFNET joint C : Indoor units (5) + (6) + (7) + (8)</p>	<p>Example REFNET joint B : Indoor units (7) + (8)</p>	<p>Example REFNET header : Indoor units (1) + (2) + (3) + (4) + (5) + (6) + (7) + (8)</p>																																																																									

Pipe size selection

Refer to the diagram below and select the appropriate piping from the tables on the right.

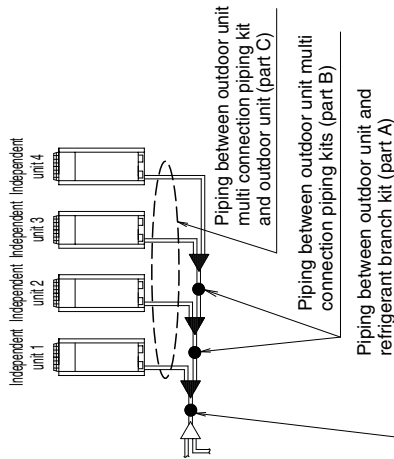

Piping between outdoor unit (*2) and refrigerant branch kit (part A).
 ● Choose from the following table in accordance with the outdoor unit system capacity type.

Model name of outdoor unit system	Suction gas pipe		HP/LP gas pipe		Liquid pipe	
	Standard size	Maximum size	Standard size	Maximum size	Standard size	Maximum size
Q280 type	φ22.2	φ28.6	φ19.1	φ22.2	φ9.5	φ12.7
Q360 type	φ25.4	φ28.6	φ19.1	φ22.2	φ12.7	φ15.9
Q460 type		φ28.6	φ22.2	φ25.4	φ15.9	φ19.1
Q500 type		φ28.6	φ25.4	φ28.6	φ19.1	φ22.2
Q636 type		φ34.9	φ41.3	φ28.6	φ19.1	φ22.2
Q712 type		φ34.9	φ41.3	φ28.6	φ19.1	φ22.2
Q816 type		φ34.9	φ41.3	φ28.6	φ19.1	φ22.2
Q848 type		φ34.9	φ41.3	φ28.6	φ19.1	φ22.2

Piping between outdoor unit multi connection piping kits (part B).
 ● Choose from the following table in accordance with the total capacity of all the outdoor units connected upstream.

Outdoor unit capacity type	Suction gas pipe		HP/LP gas pipe		Liquid pipe	
	Standard size	Maximum size	Standard size	Maximum size	Standard size	Maximum size
280-320	φ22.2	φ25.4	φ19.1	φ22.2	φ9.5	φ12.7
360-392		φ25.4	φ19.1	φ22.2	φ12.7	φ15.9
424		φ28.6	φ22.2	φ25.4	φ15.9	φ19.1
500-532		φ28.6	φ22.2	φ25.4	φ15.9	φ19.1
604-636		φ28.6	φ22.2	φ25.4	φ15.9	φ19.1

Piping between outdoor unit multi connection piping kit and outdoor unit (part C).
 ● Choose from the following table in accordance with the capacity type of the outdoor unit connected.

Outdoor unit capacity type	Suction gas pipe		HP/LP gas pipe		Liquid pipe	
	Standard size	Maximum size	Standard size	Maximum size	Standard size	Maximum size
Q140 type	φ15.9	φ19.1	φ12.7	φ15.9	φ9.5	φ12.7
Q180-212 type	φ19.1	φ22.2	φ15.9	φ19.1	φ9.5	φ12.7

Piping between refrigerant branch kits.
 Piping between refrigerant branch kit and BS unit.
 Piping between BS unit and refrigerant branch kit.

● Choose from the following table in accordance with the total capacity type of all the indoor units connected downstream.

*1 Connection piping must not exceed the refrigerant piping size between outdoor unit and refrigerant branch kit (part A).

*2 When selecting 2 pipes line (gas pipe and liquid pipe), use suction gas pipe column for gas pipe and liquid pipe column for liquid pipe.

Indoor capacity index	Suction gas pipe		HP/LP gas pipe		Liquid pipe	
	Standard size	Maximum size	Standard size	Maximum size	Standard size	Maximum size
< 56 kW	φ12.7	φ15.9	φ9.5	φ12.7	φ6.4	φ9.5
56 kW ≤ x < 112 kW	φ15.9	φ19.1	φ12.7	φ15.9	φ9.5	φ12.7
112 kW ≤ x < 160 kW	φ19.1	φ25.4	φ15.9	φ19.1	φ9.5	φ12.7
160 kW ≤ x < 180 kW	φ19.1	φ25.4	φ15.9	φ19.1	φ9.5	φ12.7
180 kW ≤ x < 224 kW	φ22.2	φ28.6	φ19.4	φ22.2	φ12.7	φ15.9
224 kW ≤ x < 330 kW	φ25.4	φ28.6	φ25.4	φ28.6	φ12.7	φ15.9
330 kW ≤ x < 370 kW	φ28.6	φ34.9	φ25.4	φ28.6	φ12.7	φ15.9
370 kW ≤ x < 470 kW	φ28.6	φ34.9	φ25.4	φ28.6	φ12.7	φ15.9
470 kW ≤ x < 530 kW	φ34.9	φ41.3	φ28.6	φ34.9	φ12.7	φ15.9
530 kW ≤ x < 710 kW	φ34.9	φ41.3	φ28.6	φ34.9	φ12.7	φ15.9
710 kW ≤ x < 784 kW	φ34.9	φ41.3	φ28.6	φ34.9	φ12.7	φ15.9
784 kW ≤ x < 1010 kW	φ34.9	φ41.3	φ28.6	φ34.9	φ12.7	φ15.9
1010 kW ≤	φ34.9	φ41.3	φ28.6	φ34.9	φ12.7	φ15.9

Piping between refrigerant branch kit, BS unit and indoor unit.
 ● Match to the size of the connection piping on the indoor unit.

Indoor capacity index	Suction gas pipe		HP/LP gas pipe		Liquid pipe	
	Standard size	Maximum size	Standard size	Maximum size	Standard size	Maximum size
Q20						
Q25						
Q32						
Q40						
Q50						
Q63						
Q80						
Q100						
Q125						
Q200	φ19.1	φ22.2	φ15.9	φ19.1	φ9.5	φ12.7
Q250	φ19.1	φ22.2	φ15.9	φ19.1	φ9.5	φ12.7

How to calculate the additional refrigerant to be charged.

Additional refrigerant to be charged : R(kg)
(R should be rounded off in units of 0.1 kg.)

$$R = \left[\left(\frac{\text{Total length(m) of liquid piping size at } \phi 22.2}{0.37} \times \text{kg/m} \right) + \left(\frac{\text{Total length(m) of liquid piping size at } \phi 19.1}{0.26} \times \text{kg/m} \right) + \left(\frac{\text{Total length(m) of liquid piping size at } \phi 15.9}{0.18} \times \text{kg/m} \right) + \left(\frac{\text{Total length(m) of liquid piping size at } \phi 12.7}{0.12} \times \text{kg/m} \right) + \left(\frac{\text{Total length(m) of liquid piping size at } \phi 9.5}{0.059} \times \text{kg/m} \right) + \left(\frac{\text{Total length(m) of liquid piping size at } \phi 6.4}{0.022} \times \text{kg/m} \right) \right] \times 1.02$$

Correction amount by outdoor unit

RQCEQ280	5.2	RQCEQ636	11.2
RQCEQ360	5.8	RQCEQ712	13.8
RQCEQ460	9.1	RQCEQ744	14.3
RQCEQ500	9.4	RQCEQ816	15.1
RQCEQ540	9.7	RQCEQ848	15.6

A ≤ 100%	0 kg
A > 100%	0.5 kg

(A: The ratio of total capacity index of connectable indoor units to outdoor capacity index (%))

Example for refrigerant branch using REFNET joint and REFNET header for the systems and each pipe length as shown below.

Outdoor system : RQCEQ848PY13
Total capacity of indoor unit : 116%

a : φ19.1 × 30m	e : φ9.5 × 10m	i : φ9.5 × 10m	m : φ9.5 × 20m	r : φ9.5 × 1m	v : φ15.9 × 3m
b : φ19.1 × 20m	f : φ9.5 × 10m	j : φ9.5 × 10m	n : φ9.5 × 10m	s : φ9.5 × 1m	w : φ12.7 × 3m
c : φ9.5 × 10m	g : φ9.5 × 10m	k : φ9.5 × 20m	o : φ6.4 × 10m	t : φ9.5 × 1m	
d : φ9.5 × 10m	h : φ9.5 × 10m	l : φ9.5 × 20m	p : φ6.4 × 10m	u : φ9.5 × 3m	

$$R = \left(\frac{50 \times 0.26}{a, b} + \frac{3 \times 0.18}{v} + \frac{3 \times 0.12}{w} + \frac{156 \times 0.059}{c-n, r-u} + \frac{20 \times 0.022}{o, p} \right) \times 1.02 - \frac{15.6}{RQCEQ848PY13} + \frac{0.5}{112\%}$$

$$= 8.915 \rightarrow \boxed{8.9 \text{ kg}}$$

Round off in units of 0.1 kg.

Note 1.

When the equivalent pipe length between outdoor unit multi connection piping and indoor units is 90m or more, the size of main pipes on the liquid side (refer to figure 9) must be increased according to the right table.
(Do not increase the size of the suction gas pipe and HP/LP gas pipe.)

(Refer to figure 10.2)

1. Outdoor unit
2. Main pipes
3. Increase only liquid pipe size
4. First refrigerant branch kit
5. BS unit
6. Indoor unit

System	Liquid pipe
RQCEQ280P	φ9.5 → φ12.7
RQCEQ360-460P	φ12.7 → φ15.9
RQCEQ500-712P	φ15.9 → φ19.1
RQCEQ744-848P	φ19.1 → φ22.2

7. FIELD WIRING

CAUTION

- All field wiring and components must be installed by a licensed electrician and must comply with relevant local and national regulations.
- Be sure to use a dedicated power circuit. Never use a power supply shared by another appliance.
- Never install a phase advancing capacitor. As this unit is equipped with an inverter, installing a phase advancing capacitor will not only deteriorate power factor improvement effect, but may also cause abnormal heating of the capacitor due to high-frequency waves.
- Only proceed with wiring work after blocking off all power.
- Always ground wires in accordance with relevant local and national regulations.
- This machine includes an inverter device. Connect earth and leave charge to eliminate the impact on other devices by reducing noise generated from the inverter device and to prevent leaked current from being charged in the outer hull of the product.
- Do not connect the ground wire to gas pipes, sewage pipes, lightning rods, or telephone ground wires.

Gas pipes: can explode or catch fire if there is a gas leak.

Sewage pipes: no grounding effect is possible if hard plastic piping is used.

Telephone ground wires and lightning rods: dangerous when struck by lightning due to abnormal rise in electrical potential in the grounding.

- Be sure to install an earth leakage circuit breaker. This unit uses an inverter, so install the earth leakage circuit breaker that be capable of handling high harmonics in order to prevent malfunctioning of the earth leakage circuit breaker itself.
- Earth leakage circuit breaker which are especially for protecting ground-faults should be used in conjunction with main switch or fuse for use with wiring.

Note

- Electrical wiring must be done in accordance with the wiring diagrams and the description herein.
- Do not operate until refrigerant piping work is completed. (If operated before complete the piping work, the compressor may be broken down.)
- Never remove thermistor, sensor or etc. when connecting power wiring and transmission wiring. (If operated with thermistor, sensor or etc. removed, the compressor may be broken down.)
- This product have reversed phase protection detector that only works when the power is turned on. If there exists black out or the power is turned on and off which the product is operating, attach a reversed phase protection circuit locally. Running the product in reversed phase may break the compressor and other parts.
- Attach the power wire securely. Introducing power with a missing N-phase or with a mistaken N-phase will break the unit.
- Never connect the power supply in reversed phase. The unit can not operate normally in reversed phase. If you connect in reversed phase, replace two of the three phases.
- Make sure the electrical unbalance ratio is no greater than 2%. If it is larger than this, the unit's lifespan will be reduced. If the ratio exceeds 4%, the unit will shut down and an malfunction code will be displayed on the indoor remote controller.
- Connect the wire securely using designated wire and fix it with attached clamp without applying external pressure on the terminal parts (terminal for power wiring, terminal for transmission wiring and earth terminal).

7-1 Power circuit, safety device, and cable requirements

- A power circuit (see the following table) must be provided for connection of the unit. This circuit must be protected with the required safety devices, i.e. a main switch, a slow blow fuse on each phase and an earth leakage circuit breaker.
- When using residual current operated circuit breakers, be sure to use a high-speed type (1 second or less) 200mA rated residual operating current.
- Use copper conductors only.
- Use insulated wire for the power cord.
- Select the power supply cable type and size in accordance with relevant local and national regulations.

- Specifications for local wiring are in compliance with IEC60245.
- Use wire type H05VV when protected pipes are used. Use wire type H07RN-F when protected pipes are not used.

	Phase and frequency	Voltage	Minimum circuit amp.	Recommended fuses
RQYQ140PY1	φ 3, 50Hz	380-415V	11.9A	15A
RQYQ180PY1	φ 3, 50Hz	380-415V	17.2A	20A
RQCYQ280PY1	φ 3, 50Hz	380-415V	23.8A	30A
RQCYQ360PY1	φ 3, 50Hz	380-415V	34.5A	40A
RQCYQ460PY1	φ 3, 50Hz	380-415V	41.0A	50A
RQCYQ500PY1	φ 3, 50Hz	380-415V	46.4A	60A
RQCYQ540PY1	φ 3, 50Hz	380-415V	51.7A	60A
RQCEQ280PY13	φ 3, 50Hz	380-415V	23.8A	30A
RQCEQ360PY13	φ 3, 50Hz	380-415V	34.5A	40A
RQCEQ460PY13	φ 3, 50Hz	380-415V	41.0A	50A
RQCEQ500PY13	φ 3, 50Hz	380-415V	46.4A	60A
RQCEQ540PY13	φ 3, 50Hz	380-415V	51.7A	60A
RQCEQ636PY13	φ 3, 50Hz	380-415V	55.5A	70A
RQCEQ712PY13	φ 3, 50Hz	380-415V	64.9A	80A
RQCEQ744PY13	φ 3, 50Hz	380-415V	66.1A	80A
RQCEQ816PY13	φ 3, 50Hz	380-415V	72.7A	90A
RQCEQ848PY13	φ 3, 50Hz	380-415V	74.0A	90A

Note

The above table indicates power specifications for standard combinations (see 2. INTRODUCTION).

Point for attention regarding quality of the public electric power supply.

This equipment complies with respectively:

- EN/IEC 61000-3-11^{*(1)} provided that the system impedance Z_{sys} is less than or equal to Z_{max} and
- EN/IEC 61000-3-12^{*(2)} provided that the short-circuit power S_{sc} is greater than or equal to the minimum S_{sc} value at the interface point between the user's supply and the public system. It is the responsibility of the installer or user of the equipment to ensure, by consultation with the distribution network operator if necessary, that the equipment is connected only to a supply with respectively:

^{*(1)} European/International Technical Standard setting the limits for voltage changes, voltage fluctuations and flicker in public low-voltage supply systems for equipment with rated current =75 A.

^{*(2)} European/International Technical Standard setting the limits for harmonic currents produced by equipment connected to public low-voltage systems with input current >16 A and =75 A per phase.

- Z_{sys} less than or equal to Z_{max} and
- S_{sc} greater than or equal to the minimum S_{sc} value.

- Heat Pump series (RQ(C)YQ)

	Z_{max} (Ω)	Minimum S_{sc} value
RQYQ140	No requirements	906902
RQYQ180	No requirements	1179734
RQCYQ280=RQYQ140+RQYQ140	No requirements	1813804
RQCYQ360=RQYQ180+RQYQ180	No requirements	2359468
RQCYQ460=RQYQ140+RQYQ140+RQYQ180	No requirements	2993538
RQCYQ500=RQYQ140+RQYQ180+RQYQ180	No requirements	3266370
RQCYQ540=RQYQ180+RQYQ180+RQYQ180	No requirements	3539202

- Heat Recovery series (RQCEQ)

	Z _{max} (Ω)	Minimum S _{sc} value
RQCEQ280=RQE140+RQE140	No requirements	1813804
RQCEQ360=RQE180+RQE180	No requirements	2359468
RQCEQ460=RQE140+RQE140+RQE180	No requirements	2993538
RQCEQ500=RQE140+RQE180+RQE180	No requirements	3266370
RQCEQ540=RQE180+RQE180+RQE180	No requirements	3539202
RQCEQ636=RQE212+RQE212+RQE212	No requirements	3422187
RQCEQ712=RQE140+RQE180+RQE180+RQE212	No requirements	4407099
RQCEQ744=RQE140+RQE180+RQE212+RQE212	No requirements	4368094
RQCEQ816=RQE180+RQE212+RQE212+RQE212	No requirements	4601921
RQCEQ848=RQE212+RQE212+RQE212+RQE212	No requirements	4562916

7-2 Wiring Connection Example for Whole System

- Heat Pump series (RQ(C)YQ)
(Refer to figure 19.1)
 - Power supply
 - Main switch
 - Earth leakage circuit breaker
 - Fuse
 - Outdoor unit
 - COOL/HEAT selector
 - Remote controller
 - Indoor unit
- Heat Recovery series (RQCEQ)
(Refer to figure 19.2)
 - Power supply
 - Main switch
 - Earth leakage circuit breaker
 - Fuse
 - Outdoor unit
 - COOL/HEAT selector
 - Remote controller
 - Indoor unit
 - BS unit

Note

- Make sure the weak electric wiring (i.e. for the remote controller, between units, etc.) and the power wiring do not pass near each other, keeping them at least 50 mm apart. Proximity may cause electrical interference, malfunctions, and breakage.
- Be sure to connect the power wiring to the power wiring terminal block and secure it as described in "7-5 Power Wiring Connection Procedure".
- Transmission wiring should be secured as described in "7-4 Transmission Wiring Connection Procedure".
- Secure wiring with clamp such as insulation lock ties to avoid contact with piping.
- Shape the wires to prevent the structure such as the EL.COMPO.BOX lid deforming. And close the cover firmly.

7-3 Leading wire Procedure

- The power wiring and ground wiring are passed out from the power wiring hole on the sides, the front (knock hole) or the bottom frame (knock hole).
- The transmission wiring is passed out from the wiring hole (knock hole) on the front of the unit or from a piping hole.
(Refer to figure 20)
 - Electrical wiring diagram
 - On the back of the EL.COMPO.BOX lid
 - Power wiring, ground wiring (inside conduit)
 - (When the wiring is routed out through the side panel)
 - Transmission wiring
 - Pipe opening
 - Conduit
 - For power wiring and ground wiring
 - Through cover
 - Cut off the shaded zones before use
 - Burr
 - Knockout hole
 - For transmission wiring

Note

- Open the knock holes with a hammer or the like.
- After knocking out the holes, we recommend you remove any burrs and paint them using the repair paint to prevent rusting.
- When passing wiring through the knock holes, remove burrs around the knock holes and protect the wiring with protective tape. (Refer to figure 20)

- If small animals might enter the unit, block off any gaps (hatching parts in figure 20) with material (field supply).

7-4 Transmission Wiring Connection Procedure

- Referring to figure 21, 22 connect the transmission wiring between outdoor unit and indoor unit, outdoor unit and outdoor unit of other system, outdoor unit and outdoor unit of same system (only multi system) or to COOL/HEAT selector.

- Heat Pump series (RQ(C)YQ)
(Refer to figure 21.1)
 - Connection example for single system
 - Outdoor unit
 - COOL/HEAT selector
 - To outdoor unit of other system
 - Match up terminal symbols (Has polarity)
 - Use duplex wires
 - Indoor unit
 - Never connect the power wire
- Heat Recovery series (RQCEQ)
(Refer to figure 21.2)
 - EL.COMPO.BOX
 - Never connect the power wire
 - To outdoor unit of other system
 - Use duplex wires (No polarity)
 - BS unit
 - Indoor unit
 - Indoor unit (Cooling only)

(Refer to figure 22)

- Connection example for multi system
 - Outdoor unit A (Master unit)
 - Outdoor unit B (Sub unit)
 - COOL/HEAT selector
 - To indoor unit
 - To outdoor unit of other system
- All transmission wiring is to be procured onsite. All wiring should use sheathed vinyl cord 0.75-1.25 mm² or cable (duplex). (Triplex only for the COOL/HEAT selector.)
 - Transmission wiring (About the symbol ① ~ ③, see figure 21, 22) should be done within the following limitations. If they are exceeded, transmission problems may occur.

① Between outdoor unit and indoor unit

Between outdoor unit and outdoor unit of other systems

Max. wiring length	: 1,000 m
Max. total wiring length	: 2,000 m
Max. no. of branches	: 16

[Note]
No branch is allowed after branch
(See figure 23)

Max. no. of outdoor units of other system that can be connected : 10

(Refer to figure 23)

- Outdoor unit
- Indoor unit
- Branch line 1
- Branch line 2
- No branch is allowed after branch
- Main line
- Central remote controller, etc.
- Branch line 3
- Transmission wiring between outdoor unit and indoor unit
- Transmission wiring between outdoor unit and outdoor unit

② Between outdoor unit and outdoor unit of same system

(Only for multi system)

Max. wiring length : 30 m

③ Transmission wiring to COOL/HEAT selector

Max. wiring length : 500 m

- The transmission wiring inside the EL.COMPO.BOX should be secured using the clamp (2) as shown in figure 24.

(Refer to figure 24)

- In the EL.COMPO.BOX
- Retain to the EL.COMPO.BOX with the accessory clamp (2)

- Outside the units, the transmission wiring must be finished simultaneously with the local refrigerant piping, and wound with tape (field supply) as shown in figure 25.
- Heat Pump series (RQ(C)YQ)
 - (Refer to figure 25.1)
 - 1. Liquid pipe
 - 2. Gas pipe
 - 3. Transmission wiring
 - 4. Insulation material
 - 5. Finishing tape
- Heat Recovery series (RQCEQ)
 - (Refer to figure 25.2)
 - 1. Suction gas pipe
 - 2. HP/LP gas pipe
 - 3. Liquid pipe
 - 4. Insulation material
 - 5. Finishing tape
 - 6. Transmission wiring
- For multi system:
 1. Transmission wiring between outdoor units in the same piping system must be connected to terminals Q1 and Q2 (TO MULTI UNIT).
Connecting the wires to the F1, F2 (TO OUT/D UNIT) terminals results in system malfunction.
 2. Wiring to other systems should be connected to terminals F1 and F2 (TO OUT/D UNIT) on the PC-board of the master unit. The outdoor unit that connected transmission wiring to indoor unit is the master unit. The others are sub units.

CAUTION

- Do not connect the power wiring to terminals for the transmission wiring. Doing so would destroy the entire system.
- When connecting wires to the terminal block on the PC-board, too much heat or tightening could damage the PC-board. Attach with care.
See the table below for the tightening torque of the transmission wiring terminals.

Screw size	Tightening torque (N · m)
M3 (A5P)	0.53 - 0.63
M3.5 (A1P)	0.80 - 0.96

7-5 Power Wiring Connection Procedure

Be sure to connect the power supply wiring to the power supply terminal block and hold it in place using the included clamp as shown in the figure 26.

(Refer to figure 26)

1. Power supply (3N~50Hz 380-415V)
 2. Earth leakage circuit breaker
 3. Branch switch, Overcurrent breaker
 4. Ground wire
 5. Attach insulation sleeves
 6. Power supply terminal block
 7. Ground terminal
 8. Clamp (2) (accessory)
- The L1, L2, L3 and N phases of the power wiring should be secured separately to the hook using the included clamp (2).
 - The ground wiring should be bound to the power wiring using the included clamp (2) to prevent outside force from being applied to the terminal area.
 - Wire so that the ground wiring does not come into contact with the compressor lead wiring. If they touch, this may have an adverse effect on other devices.

CAUTION

- Be sure to use crimp-style terminal with insulating sleeves for connections. (See the figure below.)

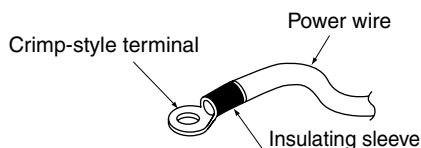

- For wiring, use the designated power wire and connect firmly, then secure to prevent outside pressure being exerted on the terminal board.

- Use an appropriate screwdriver for tightening the terminal screws. A screwdriver with a small head will strip the head and make proper tightening impossible.
- Over-tightening the terminal screws may break them. See the following table for the tightening torque of the terminal screws.

Screw size	Tightening torque (N·m)
M8 Power terminal	5.5 ~7.2
M8 Ground terminal	9.7~11.7

- When pulling the ground wire out, wire it so that it comes through the cut out section of the cup washer. (See the figure below.) An improper ground connection may prevent a good ground from being achieved.

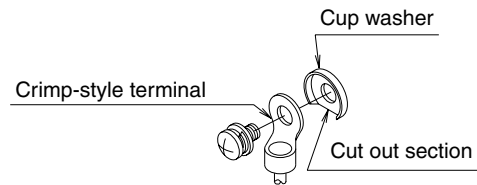

- When two wires are connected to a single terminal, connect them so that the rear sides of the crimp contacts face each other. Also, make sure the thinner wire is on top, securing the two wires simultaneously to the resin hook using the included clamp (2).

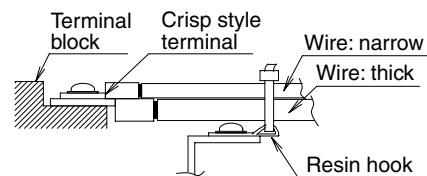

7-6 Procedure for Wiring Inside Units

- Refer to figure 27 for routing guide for power supply and transmission wiring.

(Refer to figure 27)

1. Electric conduit
 2. When routing out the power/ground wires from the left side
 3. When routing out the transmission wiring from the opening for piping
 4. When routing out the power/ground wires from the front
 5. Leave at least 50 mm clearance
 6. When routing out the transmission wiring from the knockout hole
 7. Retain to the back of the column support with the accessory clamp (3)
 8. When routing out the power/ground wires from the right side
 9. Power wiring
 10. Transmission wiring
 11. Ground wire
- Secure wiring using the included clamp (1) as necessary.

CAUTION

- The transmission wiring must be at least 50 mm away from the power wiring.
- Make sure all wiring do not contact to the pipes (hatching parts in the figure 27).
- After wiring work is completed, check to make sure there are no loose connections among the electrical parts in the EL.COMPO.BOX.

8. AIR TIGHT TEST AND VACUUM DRYING

Note

- Always use nitrogen gas for the airtightness test.
- Absolutely do not open the shutoff valve until the main power circuit insulation measurement has been completed. (measuring after the shutoff valve is opened will cause the insulation value to drop.)

8-1 Preparations

<Required tools>

Gauge manifold, Charge hose valve	<ul style="list-style-type: none"> To prevent entry of any impurities and insure sufficient pressure resistance, always use the special tools dedicated for R410A. Use a charge hose that has pushing stick for connecting to service port of shutoff valves or refrigerant charge port.
Vacuum pump	<ul style="list-style-type: none"> The vacuum pump for vacuum drying should be able to lower the pressure to -100.7kPa (5 Torr -755mm Hg). Take care the pump oil never flow backward into the refrigerant pipe during the pump stops.

<The system for air tight test and vacuum drying>

- Referring to figure 28.1 and 28.2, connect on nitrogen tank and a vacuum pump to the outdoor unit.
 - Heat Pump series (RQ(C)YQ)
 - (Refer to figure 28.1)
 - Gauge manifold
 - Nitrogen
 - Vacuum pump
 - Charge hose
 - Valve A
 - Liquid side shutoff valve
 - Gas side shutoff valve
 - Refrigerant charge port
 - Outdoor unit
 - To indoor unit
 - Interunit piping
 - Flow of the gas
 - Service port
 - Heat Recovery series (RQCEQ)
 - (Refer to figure 28.2)
 - Gauge manifold
 - Nitrogen
 - Vacuum pump
 - Charge hose
 - Valve A
 - Liquid side shutoff valve
 - Suction gas side shutoff valve
 - HP/LP gas side shutoff valve
 - Refrigerant charge port
 - Outdoor unit
 - To indoor unit
 - Interunit piping
 - Flow of the gas
 - Service port

Note

- The airtightness test and vacuum drying should be done using the liquid side and gas side shutoff valve service ports. See the [R410A] Label attached to the front plate of the outdoor unit for details on the location of the service port (see figure at right).
- See [Shutoff valve operation procedure] in "11-1 Before working" for details on handling the shutoff valve.
- The refrigerant charge port is connected to unit pipe. When shipped, the unit contains the refrigerant, so use caution when attaching the charge hose.

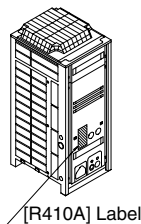

8-2 Air tight test and vacuum drying method

After finished piping work, carry out air tight test and vacuum drying.

<Air tight test>

Pressurize the liquid and gas pipes to 3.3MPa (33bar) (do not pressurize more than 3.3MPa (33bar)). If the pressure does not drop within 24 hours, the system passes the test. If there is a pressure drop, check for leaks, make repairs and perform the airtight test again.

<Vacuum drying>

Evacuate the system from the liquid and gas pipes by using a vacuum pump for more than 2 hours and bring the system to -100.7kPa or less. After keeping the system under that condition for more than 1 hour, check if the vacuum gauge rises or not. If it rises, the system may either contain moisture inside or have leaks.

Note



If moisture might enter the piping, follow belows.

(I.e., if doing work during the rainy season, if the actual work takes long enough that condensation may form on the inside of the pipes, if rain might enter the pipes during work, etc.)

- After performing the vacuum drying for two hours, pressurize to 0.05MPa (i.e., vacuum breakdown) with nitrogen gas, then depressurize down to -100.7kPa for an hour using the vacuum pump (vacuum drying).
- If the pressure does not reach -100.7kPa even after depressurization for at least two hours, repeat the vacuum breakdown - vacuum drying process.

After vacuum drying, maintain the vacuum for an hour and make sure the pressure does not rise by monitoring with a vacuum gauge.

9. PIPE INSULATION

- Insulation of pipes should be done after performing "8. AIR TIGHT TEST AND VACUUM DRYING".
- Especially the HP/LP gas side piping is required to be insulated as suction gas side piping in cooling operation. (Heat Recovery series.)
- Always insulate the liquid side piping, gas side piping, HP/LP gas side piping and suction gas piping in the interunit piping and refrigerant branching kit. Failing to insulate the pipes could cause leaking or burns. (The HP/LP gas side and gas side piping can reach temperatures of 120°C . Be sure the insulation used can withstand such temperatures.)
- Reinforce the insulation on the refrigerant piping according to the installation environment. Condensation might form on the surface of the insulation.
 - Ambient temperature: 30°C , humidity: 75% to 80% RH: min. thickness: 15 mm.
 - If the ambient temperature exceeds 30°C and the humidity 80% RH, then the min. thickness is 20 mm.
- If there is a possibility that condensation on the shutoff valve might drip down into the indoor unit through gaps in the insulation and piping because the outdoor unit is located higher than the indoor unit, etc., this must be prevented by caulking the connections, etc. (Refer to figure 29.1, 29.2)
- The piping lead-out hole lid should be attached after opening a knock hole. (Refer to figure 30)
- If small animals and the like might enter the unit through the piping lead-out hole, close the hole with blocking material (procured onsite) after completion of "11. ADDITIONAL REFRIGERANT CHARGE AND CHECK OPERATION". (Refer to figure 30)
 - Heat Pump series (RQ(C)YQ)
 - (Refer to figure 29.1)
 - Gas side shutoff valve
 - RQYQ is not used
 - Liquid side shutoff valve
 - Indoor interunit piping
 - Insulation material
 - Use caulking or similar sealant
 - Heat Recovery series (RQCEQ)
 - (Refer to figure 29.2)
 - HP/LP gas side shutoff valve
 - Suction gas side shutoff valve
 - Liquid side shutoff valve
 - Indoor interunit piping
 - Insulation material
 - Use caulking or similar sealant
 - (Refer to figure 30)
 - Piping lead-out hole lid
 - Open a knock hole at "
 - Block "

Note

- After knocking out the holes, we recommend you remove burrs in the knock holes (see figure 30) and paint the edges and areas around the edges using the repair paint.

10. CHECKING OF DEVICE AND INSTALLATION CONDITIONS

Be sure to check the followings.

For electrical work

1. Make sure there is no faulty transmission wiring or loosening of a nut.
See "7-4 Transmission Wiring Connection Procedure".
2. Make sure there is no faulty power wiring and ground wiring or loosening of a nut.
See "7-5 Power Wiring Connection Procedure".
3. Has the insulation of the main power circuit deteriorated?
Measure the insulation and check the insulation is above regular value in accordance with relevant local and national regulations.

For those doing pipe work

1. Make sure piping size is correct.
See "6-1 Selection of piping material and Refrigerant branching kit".
2. Make sure insulation work is done.
See "9. PIPE INSULATION".
3. Make sure there is no faulty refrigerant piping.
See "6. REFRIGERANT PIPING".

11. ADDITIONAL REFRIGERANT CHARGE AND CHECK OPERATION

The outdoor unit is charged with refrigerant when shipped from the factory, but depending on the size and length of the piping when installed, it may require additional charging. For charging the additional refrigerant, follow the procedure in this chapter.

And then carry out the check operation.

11-1 Before working

[About the refrigerant tank]

Check whether the tank has a siphon pipe before charging and place the tank so that the refrigerant is charged in liquid form. (See the figure below.)

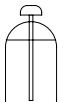
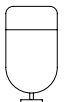
With siphon pipe	
	Stand the tank upright and charge. (The siphon pipe goes all the way inside, so the tank does not need be put upside-down charge in liquid form.)
Other tanks	
	Stand the tank upside-down and charge.

CAUTION

- Always use the proper refrigerant (R410A). If charged with the refrigerant containing an improper material, it may cause an explosion or accident.
- R410A is a mixed refrigerant, so charging it as a gas will cause the refrigerant composition to change, which may prevent normal operation.

[Shutoff valve operation procedure]

When operating the shutoff valve, follow the procedure instructed below.

Note

- Do not open the shutoff valve until "10. CHECKING OF DEVICE AND INSTALLATION CONDITIONS" are completed. If the shutoff valve is left open without turning on the power, it may cause refrigerant to buildup in the compressor, leading insulation degradation.
- Be sure to use the correct tools.
The shutoff valve is not a back-seat type. If forced open, it might break the valve body.
- When using a service port, use the charge hose.
- After tightening the cap, make sure no refrigerant gas is leaking.

[Tightening torque]

The sizes of the shutoff valves on each model and the tightening torque for each size are listed in the table below.

<Size of Shutoff Valve>

- Heat Pump series (RQ(C)YQ)

Usage	Q140 type	Q180 type
Liquid side shutoff valve	φ 9.5	
Gas side shutoff valve	φ 15.9 Q180 type is correspond to the field piping φ19.1 by accessory piping.	

- Heat Recovery series (RQCEQ)

Usage	Q140 type	Q180 type	Q212 type
Liquid side shutoff valve	φ 9.5		
Gas side shutoff valve	φ 15.9 Q180 and Q212 type are correspond to field piping φ19.1 by accessory piping.		
HP/LP gas side shutoff valve	φ 15.9 Q140 type is correspond to field piping φ12.7 by accessory piping.		

<Tightening torque>

- Heat Pump series (RQ(C)YQ)

Shutoff valve size	Tightening torque N·m (Turn clockwise to close)			Service port
	Shaft (valve body)		Cap (valve lid)	
φ 9.5	5.4 ~ 6.6	Hexagonal wrench : 4 mm	13.5 - 16.5	11.5 ~ 13.9
φ 15.9	13.5 ~ 16.5	Hexagonal wrench : 6 mm	22.5 - 27.5	

- Heat Recovery series (RQCEQ)

Shutoff valve size	Tightening torque N·m (Turn clockwise to close)			Service port
	Shaft (valve body)		Cap (valve lid)	
φ 9.5	5.4 ~ 6.6	Hexagonal wrench : 4 mm	13.5 ~ 16.5	11.5 ~ 13.9
φ 15.9	13.5 ~ 16.5	Hexagonal wrench : 6 mm	22.5 ~ 27.5	

(Refer to figure 33)

1. Service port
2. Cap
3. Hex holes
4. Shaft (valve body)
5. Seal section

[To open]

1. Remove the cap and turn the shaft counterclockwise with the hexagon wrench (JISB4648).
2. Turn it until the shaft stops.
3. Make sure to tighten the cap securely.
(For the tightening torque, refer to the item <Tightening Torque>.)

[To close]

1. Remove the cap and turn the shaft clockwise with the hexagon wrench (JISB4648).
2. Securely tighten the valve until the shaft contacts the main body seal.
3. Make sure to tighten the cap securely.
(For the tightening torque, refer to the item <Tightening Torque>.)

[How to Check How Many Units are Connected]

It is possible to find out how many indoor or outdoor unit in the system are turned on by operating the push button on the PC-board (A1P) of outdoor unit (In case of multi system master unit).

Follow the procedure below to check how many indoor or outdoor units are turned on.

(LED display: ● ...OFF ○ ...ON ◐ ...Blinking * ...Uncertain)	LED display						
	H1P	H2P	H3P	H4P	H5P	H6P	H7P
(1) Press the MODE button (BS1) once, and set the MONITOR MODE (H1P: Blinking).	◐	●	●	●	●	●	●
(2) Press the SET button (BS2) the number of times until the LED display matches that at right.	For checking the number of outdoor units: eight times	◐	●	●	○	●	●
	For checking the number of indoor units: five times	◐	●	●	●	○	○
(3) Press the RETURN button (BS3) and read the number of units from the display of H2P through H7P. [Reading Method] The display of H2P through H7P should be read as a binary number, with ◐ standing for "1" and ● standing for "0".	◐	*	*	*	*	*	*
<p>Ex: For the LED display at right, this would be "010110", which would mean 22 units are connected.</p> $32 \times 0 + 16 \times 1 + 8 \times 0 + 4 \times 1 + 2 \times 1 + 1 \times 0 = 22 \text{ units}$ <p>Note: "000000" indicates 64 units.</p>	◐	●	◐	●	◐	◐	●
(4) Press the "MODE button" (BS1) once. This returns to Setting Mode 1 (default).	●	●	○	●	●	●	●

Note 

Press the "MODE button" (BS1) if you get confused while operating. This returns to **Setting Mode 1** (default).

- Refer to "■ Function of push-button" on page 24.

1. Check of power supply

- Make sure to turn on both indoor, BS and outdoor units. If check operated when any of the indoor units is not turned on, check of refrigerant amount is not completed properly.
- Make sure to turn on all the connected indoor units. Please see **[How to Check How Many Units are Connected]** (Descriptions on above) for checking numbers of connected indoor units from an outdoor unit.

11-2 Procedure of check operation

⚠ WARNING ⚠ ELECTRIC SHOCK WARNING

- Make sure to close the EL. COMPO. BOX lid before turning on the power when performing the refrigerant charging operation.
- Perform the setting on the PC-board (A1P) of the outdoor unit and check the LED display after the power is on via the inspection door which is in the EL. COMPO. BOX lid.
- Use an insulated rod to operate the push buttons via the EL. COMPO. BOX's inspection door. There is a risk of electric shock if you touch any live parts, since this operation must be performed with the power on.

(Refer to figure 32)

1. EL.COMPO.BOX lid
2. DIP switch (DS1-1~4)
3. Inspection door
4. Label "Service Precaution"
5. LED (H1~8P)
6. Push button (BS1-5)
7. Lift the protruding part to open the cover

⚠ CAUTION

- Make sure to use the protect tool (protective grooves and goggles) when charging the refrigerant.
- Due to a danger of liquid hammer, the refrigerant must not be charged over the allowable maximum amount when charging the refrigerant.
- Do not perform the refrigerant charging operation under working for BS and indoor unit. (BS unit is used only RQCEQ series.)
- When opening the front panel, make sure to take caution to the fan rotation during the working. After the outdoor unit stops operating, the fan may keep rotation for a while.

Note 

- If operation is performed within 12 minutes after the indoor and outdoor units are turned on, H2P will be lit on and the compressor will not operate.
 - In order to ensure uniform refrigerant distribution, it may take up to around 10 minutes for the compressor to start up after the unit starting operating. This is not a malfunction.
- <About refrigerant charging>
- The refrigerant charge port is connected to the piping inside the unit. When the unit is shipped from the factory, the unit's internal piping is already charged with refrigerant, so be careful when connecting the charge hose.
 - After adding the refrigerant, make sure to close the lid of the refrigerant charging port. The tightening torque for the lid is 11.5 to 13.9 Nm.
 - See [Shutoff valve operation procedure] in chapter 11-1 for details on how to handle shutoff valves.
 - When done or when pausing the refrigerant charging operation, close the valve of the refrigerant tank immediately. If the tank is left with the valve open, the amount of refrigerant which is properly charged may be off the point. More refrigerant may be charged by any remaining pressure after the machine is stopped.
- <About check operation>
- **Make sure to perform the check operation after installation. Otherwise, the malfunction code "U3" will be displayed and normal operation cannot be performed.** And the failure of "Check of miswiring" may also cause abnormal operation. Performance may drop due to the failure of "Judgment of piping length".
 - Check operation must be performed for each refrigerant piping system. Checking is impossible if multiple systems are being done at once.

- The individual problems of indoor units can not be checked. About these problems check by test run after the check operation is completed. (See chapter 13)
- The check operation cannot be performed in recovery or other service modes.

<About re-charging of refrigerant>

- When sizes and length of field pipings are certain, figure out the re-charging amount of refrigerant by calculation method of refrigerant charging amount on the installation manual, then charge according to "6-5. Example of connection". (Check operation time shall be shortened.)
Although there supposed to be no re-charging amount required by calculation, it still occasionally needed to be re-charged depending on the installation circumstances, etc.
- In case of long pipings, but sizes and length of field pipings are not certain, indication for re-charging of refrigerant is shown by outdoor unit LED and (for BRC1A52) on the remote controller. Please see the remote controller indication list at "11-2. Procedure of check operation".

<Notes on check operation>

- If operated within approx. 12 min. after turning on the indoor, BS and outdoor units, H2P will light-on and compressor shall not start its operation.

Please start the operation after confirming the proper indication of LED according to "11-2-2. Check operation".

- For multi-connecting outdoor unit systems, operation of push-buttons and checks of LED indications shall be done at the parent unit.

Outdoor unit to which indoor unit connection wires are connected is the parent unit.

- It may takes approx. 10 min. from turning on the operation till the compressor actually starts operating. This is to equalize the refrigerant condition, not a sign of malfunction of the system.
- Indoor unit cannot be checked individually. Please check at normal operation by remote controller after this check operation.
- Do not test operate while working on the indoor units. Not only outdoor units but also indoor units are operated at the check operation.
- Please close all the outside panels except the one for electrical components box while working.
- Re-charging according to a check operation shall be done when outdoor temperature is 0°C or higher, and indoor temperature is 10°C or higher.
If outdoor temperature is too low, it drops the temperature of refrigerant tank and may not be able to charge.
If indoor temperature is too low, it may cause an excess of charging.
- Close the outside panels except when operating the push-buttons, or installing the charging tube.
- Sounds of refrigerant flow, activating of solenoid valves, etc. could be from time to time louder during operation.

11-2-1. Preparation prior to check operation

1. Make sure the following works are complete in accordance with the installation manual.

- Piping work
- Wiring work
- Air tight test
- Vacuum drying
- Installation work for indoor unit
- Installation work for BS unit (Only for RQCEQ series)

2. Calculate the "additional charging amount" using "How to calculate the additional refrigerant to be charged" in "6-5 Example of connection".

By the calculation, additional refrigerant charging is need, prepare the refrigerant tank. The size and length of the local piping are uncertain, presume the amount of additional refrigerant, and the proper refrigerant tank.

Though additional refrigerant is not need by calculation, additional refrigerant charging operation will be need according to the installation conditions.

11-2-2. Check operation

- Be sure to perform check operation after initial installation.
- If check operation is terminated abnormally, a malfunction code is displayed on the remote control. Check the malfunction code, correct the problem, and perform check operation again.
- If you attempt to resume normal operation after check operation terminates abnormally, the malfunction code "U3" is displayed and normal operation does not resume.
- Refer to the "Outdoor unit LED display after completion of check operation" to terminate the operation normally.
- Check operation performs the following tests. Perform check operation in accordance with the procedure below.
 - Check the shutoff valve open
 - Wiring error check
 - Contaminant treatment
 - Piping length calculation
 - Refrigerant amount check
 - Additional refrigerant charge (Requires connection of refrigerant tank depending on piping length.)

Note

- Perform check operation with an outside air temperature of 0°C or above and an indoor temperature of 10°C or above. Refrigerant amount checks and additional refrigerant charging operation cannot be performed correctly during check operation. (If the outside air temperature is too low, the refrigerant temperature may drop and the tank may not be re-charged. If the indoor temperature is too low, the refrigerant tank may be over-charged.)

Outdoor unit LED display after completion of check operation

	H1P	H2P	H3P	H4P	H5P	H6P	H7P
Normal termination	●	●	○	●	●	●	●
Abnormal termination	●	○	○	●	●	●	●

A malfunction code is displayed on the remote control if check operation is terminated abnormally.

[Check operation procedure]

- Heat Pump series (RQ(C)YQ)
 - Open the gas/liquid piping shutoff valve fully. (*1)
 - Adjust field settings using the dip switch (DS-1) on the outdoor unit PCB (A1P) as necessary. Refer to "Service Precaution" label (upper) on the lid of the electrical component box for instructions on field settings.
 - Shut the lid of the electrical component box, and turn on all of the outdoor and indoor units in the same refrigerant system. (In order to stop liquid compression of the compressor, always turn the power on six hours before operation and energize the crankcase heater.)
 - When installing, perform check operation in accordance with **[Check operation]**. After running the unit for about 45 minutes and no longer than 60 minutes(*2), the system automatically stops check operation. (*3)
Once check operation stops, it is completed unless a malfunction code is displayed. Normal operation is possible about 5 minutes after check operation is complete. If a malfunction code is displayed, refer to the [Remote controller displays malfunction code] and perform check operation again.

(*1)

(Refer to figure 31.1)

1. Measuring device
2. R410A tank (with siphon)
3. Charge hose
4. Refrigerant flow
5. Liquid side shutoff valve
6. Gas side shutoff valve
7. Refrigerant charge port
8. Outdoor unit
9. To indoor unit
10. Field piping

(*2) If additional charging is required from the refrigerant tank, more time is required for additional charging.

(*3) Press the "RETURN" button (BS3) on the outdoor unit PCB (A1P) if check operation is forcibly cancelled.

- Use a charging tube with a pushing projection (at the connecting end) to connect the refrigerant charging port mounted to the shutoff valve fixing plate.

- Please be careful not to leak refrigerant when connecting the charging tube.
Refrigerant charging port is mounted to internal pipings of the product, in which refrigerant is already charged by the manufacturer.

Liquid side shutoff valve	Gas side shutoff valve
open	open

- Heat Recovery series (RQCEQ)
 - Open the liquid/suction/HP-LP gas shutoff valve fully. (*1)
 - Shut the lid of the electrical component box, and turn on all of the outdoor, BS and indoor units in the same refrigerant system.
(In order to stop liquid compression of the compressor, always turn the power on six hours before operation and energize the crankcase heater.)
 - When installing, perform check operation in accordance with **[Check operation]**.
After running the unit for about 45 minutes and no longer than 60 minutes(*2), the system automatically stops check operation. (*3)
Once check operation stops, it is completed unless a malfunction code is displayed. Normal operation is possible about 5 minutes after check operation is complete.
If a malfunction code is displayed, refer to the [Remote controller displays malfunction code] and perform check operation again.

(*1)

(Refer to figure 31.2)

1. Measuring device
2. R410A tank (with siphon)
3. Charge hose
4. Refrigerant flow
5. Liquid side shutoff valve
6. Suction gas side shutoff valve
7. HP/LP gas side shutoff valve
8. Refrigerant charge port
9. Outdoor unit
10. To indoor unit
11. Field piping

(*2) If additional charging is required from the refrigerant tank, more time is required for additional charging.

(*3) Press the "RETURN" button (BS3) on the outdoor unit PCB (A1P) if check operation is forcibly cancelled.

- Use a charging tube with a pushing projection (at the connecting end) to connect the refrigerant charging port mounted to the shutoff valve fixing plate.
- Please be careful not to leak refrigerant when connecting the charging tube.
Refrigerant charging port is mounted to internal pipings of the product, in which refrigerant is already charged by the manufacturer.

Liquid side shutoff valve	Suction gas side shutoff valve	HP/LP gas side shutoff valve
open	open	open

11-2-3. After check operation

- After check operation is completed, record the actual amount of refrigerant charged from the refrigerant tank on the "Service Precaution" label (lower) on the electrical component box of the outdoor unit.
- Adjust local settings using the press switches (BS1-5) on the outdoor unit PCB (A1P) as necessary. Refer to "Field setting" in "Service Precaution" label on the lid of the electrical component box for instructions on adjusting settings.

[Check operation]

<p>Procedures</p>	<p>Operational Conditions (Each of mentioned below is a standard operation time. This may vary based on the installation circumstances, etc.)</p>
<p>(1) Turn to [Set-up Mode 1] (H1P : OFF). H1P light is usually out. If H1P is ● (BLINK) or ○ (ON), press “MODE” button (BS1) once to go into [Set-up Mode 1]. (If H2P is lighted-on, check the defect codes with a remote controller to find out the cause. Repair the defect part according to the list on the installation manual.)</p>	<p>Normal (H2P : OFF)</p> <p>Defect (H2P : ON)</p>
<p>(2) <u>After confirmed that it's back in a normal condition, press “TEST” button (BS4) for longer than 5 seconds.</u> It starts warming-up for the operation, and LED indication turns as right descriptions. <u>Close all the outside panels after putting back the service cover. (*2)</u></p>	<p><u>Startup and waiting operation for stable conditions (approx.10 to 25 min.)</u> The outdoor and indoor unit fan is operated in order to stabilize the refrigerant conditions. And then the compressor starts operation.</p>
<p style="text-align: center;">↓</p>	<p><u>Operation to check stop valve and mis-wiring (approx. 5 min.)</u> (Contamination prevention is operated at the same time.)</p>
<p style="text-align: center;">↓</p>	<p><u>Operation to check refrigerant amount (approx. 10 to 20 min.)</u> Check the refrigerant amount, and make adjustments. (Contamination prevention is operated at the same time.)</p>
<p style="text-align: center;">↓</p>	<p>The system stop operation for warming-ups before re-charging of refrigerant, then LED indicate to connect the refrigerant tank (as on the right).</p>
<p style="text-align: center;">↓</p>	<p>Stand-by for a stable condition after the re-start (approx. 1 to 3 min.).</p>
<p style="text-align: center;">↓</p>	<p>LED indicate to open the valve of the refrigerant tank (as on the right), and wait to press the “TEST” button (BS4).</p>
<p style="text-align: center;">↓</p>	<p><u>Operation for re-charging of refrigerant (1~60 min.)</u> (Contamination prevention is operated at the same time.)</p>
<p style="text-align: center;">↓</p>	<p>The system stop operation due to insufficient re-charging of refrigerant, then LED indicate to replace the refrigerant tank (as on the right).</p>
<p style="text-align: center;">↓</p>	<p><u>Automatic measuring of piping length (approx.1 min.)</u> This is to check the length of field pipings.</p>
<p>(4) • After the system stop operation, open the outside panel of the EL.compo. box, then check the LED indications through the inspection door. • When completed properly. • Disconnect the refrigerant tank. • Close all the outside panels after putting back the inspection door. • When abnormal stop. • Malfunction code is displayed on the remote controller, check the malfunction code No.</p>	<p>Properly completed (H2P : OFF)</p> <p>Abnormal stop due to the low pressure drops (H2P: Blinking)</p> <p>Defect determined (H2P : ON)</p>

When re-charging is not required

(*3) When re-charging is required

1. • When the system stop operation, open the outside panel of the EL.compo. box, then check the LED indications through the inspection door.
If the LED indicate as right, connect the refrigerant tank to the refrigerant re-charging port.
• Press the test operation button (BS4) for longer than 5 seconds after connection of the refrigerant tank.
LED change indications, then re-start. (Use a refrigerant cylinder with sufficient amount of refrigerant.)

2. • Open the valve of the refrigerant tank after LED indications turns as right. (*3)
• Press the “TEST” button (BS4) once within 3 min. after opening the valve. LED change indications.
• Immediately close the inspection door and all the outside panels. (*2)

If the malfunction code PA is displayed on the remote controller, open the outside panel of the EL. comp.box, check the LED indications through the inspection door.

LED indications ●:OFF ○:ON ◐:BLINK

MODE	HWL:○	C/H SELECTOR			L.N.O.P	DEMAND
		IND	MASTER	SLAVE		
H1P	H2P	H3P	H4P	H5P	H6P	H7P
●	●	○	●	●	●	●
●	○	○	●	●	●	●
●	◐	●	●	●	●	○
●	◐	●	●	●	○	○
LED indications to connect the refrigerant tank.						
◐	◐	◐	●	○	●	●
●	◐	●	●	○	●	●
LED indications to [open] the valve of refrigerant tank.						
◐	◐	◐	●	○	●	○
●	◐	●	●	○	●	○
LED indications as re-charging amount of refrigerant is not sufficient.						
◐	◐	◐	●	◐	●	●
●	◐	●	●	○	○	●
●	●	○	●	●	●	●
●	◐	◐	●	●	●	○
●	○	○	●	●	●	●

indications on remote controller (*1)

- A
- B
- C
- C
- D (P8)
- C
- C (*3)
- C
- D (PA)
- C
- A
- B (P2)
- B

■ Functions of push-button

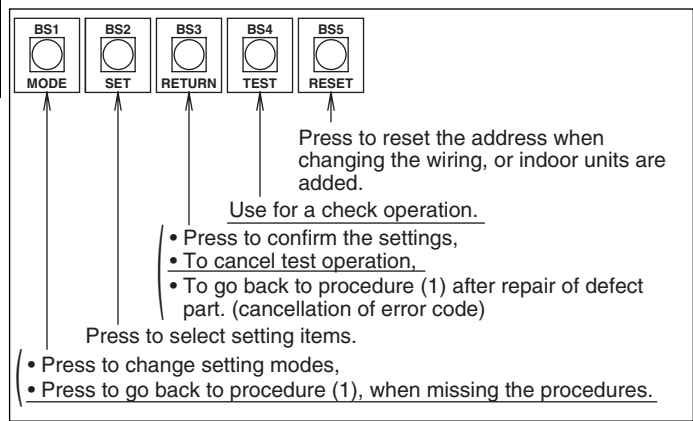

• If the system stops and a indoor remote controller indicates any defect, repair the defect part according to. [Remote controller displays malfunction code.] Test operate again after the repair.
 • To test operate again, press the "RETURN button" (BS3) to turn the LED back to "normal" indications as procedure (1).

If the "TEST" button (BS4) is not pressed within 3 min. after the indication to open the valve, it goes back to procedure (3) 1 and stops the system again.

In this case, either refrigerant tank became empty, or the valve of the refrigerant tank is not open.
 • If the refrigerant tank is empty, replace the tank, then press the "TEST" button (BS4) for longer than 5 sec. to re-start the system.
 • If the valve of the refrigerant tank is not open, press the "TEST" button (BS4) for longer than 5 sec. to re-start the system.
 Then open the valve of the refrigerant tank by following the procedure (3) 2.

• If the system stops and a indoor remote controller indicates any defect, repair the defect part according to. [Remote controller displays malfunction code.] Test operate again after the repair.
 • To check operate again, press the "RETURN" button (BS3) to turn the LED back to "normal" indications as procedure (1).

(*1): Please refer to [Remote controller indications at check operation] to confirm the details of each indication.
 (*2): If outside panels are not closed, it may not be able to operate normally when outdoor temperature is high, etc.
 (*3): Remote controller does not indicate the procedures. Make sure to check the LED indications upon operation.
 (*4): Recode the amount of refrigerant re-charge on the [Safety precaution] label.

— ⚠ WARNING ⚠ ELECTRIC SHOCK WARNING —

- Do not move away from the outdoor unit if outside panel is not closed during a test operation.
- In case you need to move away from the outdoor unit, follow either one of the below directions.
 1. Replace with other installation worker.
 2. Push the "RETURN" button (BS3) to cancel the test operation. (In this case, close all the outside panel, and close also the valve if any cylinder is connected.)

■ Remote controller indications at check operation (for BRC1A52)

A. Before check operation } Normal Indications
After check operation }

- *1 Regardless of previous settings, it always indicates for cooling operation after a check operation.
- *2 Indication of “” may occasionally blinks, light-on, or light-off, which depends on the setting of cooling/heating switch on the remote controller.
Please see the instruction manual of indoor unit for the details.

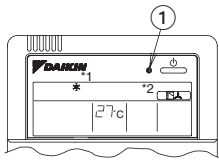

All indications are lighted-on.

- ① pilot lamp (light-off)

B. Error Codes (defect indications)

(Note) Error codes shown here are examples and only for a reference.

(1) Before check operation

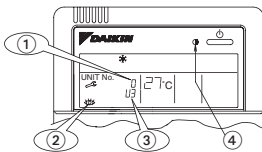

All other indications are lighted-on.

(2) During check operation

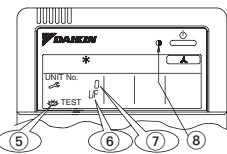

All other indications are lighted-on.

- ① ② ③ ④ ⑤ ⑥ ⑦ blinking
- ④ ⑧ pilot lamp (blinking)

Repair the defect part according to the list on. [Remote controller displays malfunction code.]

C. Indications at check operation

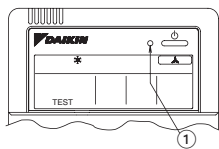

All other indications are lighted-on.

- ① pilot lamp (light-on)

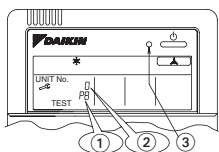

D. Indications at check operation

(For when re-charging from the refrigerant tank is required. (Compressor is not operated.))



All other indications are lighted-on.

- ① ② blinking
- ③ pilot lamp (light-on)

*Error code indicated at	Procedures to be taken
	Connect the refrigerant tank.
	<p>The refrigerant tank is empty or the refrigerant tank valve is not open.</p> <ul style="list-style-type: none"> • If the refrigerant tank is empty, replace it, and hold down the “TEST” button (BS4) for at least 5 seconds to re-start the unit. • If the refrigerant tank valve is not open, hold down the “TEST” button (BS4) for at least 5 seconds to re-start the unit. <p>After re-starting the unit, follow the instructions in procedure (3) 2 to open the refrigerant tank valve.</p>

* These codes appear on the error display, but do not indicate actual errors.

These codes indicate directions for the refrigerant re-charging process.

Actual codes displayed depend on the remote control and optional accessories used. For details, refer to [Remote controller displays malfunction code].

[Remote controller displays malfunction code]

Malfunction code	Installation error	Remedial action
A* C* (Note)	Indoor unit of connecting remote controller is malfunction.	Correct the malfunction by reference to installation manual of indoor unit or operation manual of outdoor unit.
A3	Drain level error of BS unit.	Check the drain pump connected to BS unit.
E3, F4 F3, UF	The shutoff valve of the outdoor unit is left closed.	Open the shutoff valve.
U1	The phases of the power to the outdoor unit are reversed.	Exchange two of the three phases (L1, L2, L3) and connect with the correct phase.
U3	Check operation has been completed normally.	Perform the check operation again.
U1 U4 LC	Power is not being supplied (including cases of open phase) to the outdoor or BS or indoor unit.	Supply power correctly to the outdoor, BS or indoor unit.
U7 UA	<ul style="list-style-type: none"> • A model which cannot be connected in a multi-outdoor-unit system has been connected in a multi-outdoor-unit system. • DIP switch setting of BS unit is incorrect. • Combination with A type (BSQ-AV1, BS1Q-A7, BS-Q14AV1) and P type (BSVQ-P, BSV-Q100P) cause error. 	<ul style="list-style-type: none"> • Change to individual piping, and disconnect the wiring from the multi-outdoor-unit terminals (Q1, Q2). • Set up a DIP switch referring to service precaution of BS unit. • Configure the system with only A type, or only P type.
U9	There is a problem with another BS and indoor unit within the same system.	A malfunction code is displayed on the remote controller, or else trouble has occurred at BS and indoor unit where a malfunction code is not displayed on the remote controller. Correct the trouble at the corresponding BS and indoor unit. If no malfunction code is displayed on the remote controller, press the Inspection/Test button on the remote controller to display the malfunction code.
UF	Wrong wiring between units.	Agree refrigerant system and connection wire between the units.
UF	If an outdoor - outdoor transmission wire was connected or disconnected during check operation.	Complete the transmission wiring work, then perform check operation again.
U4, U7 UH, UF	Wrong wiring between units.	Connect the interunit wiring (indoor - outdoor, outdoor - outdoor, multi-outdoor-unit). If voltage of 100V or higher was applied to the outdoor unit PCB (A1P), the outdoor unit PCB or BS unit PCB may be damaged. If the malfunction display "UH" appears even after the connection was corrected, the PCB must be replaced. Refer to Service Manual for details.
PJ	DIP switch (DS1) setting is incorrect after the outdoor unit PCB (A1P) was replaced.	Follow the information on spare parts with a spare PCB of outdoor unit and make the correct setting.

Malfunction code	Installation error	Remedial action
P2	Check operation cannot be continued by the low pressure drops.	Check the following. <ul style="list-style-type: none"> • All shutoff valves are open. • Refrigerant tank is connected. • Valve of refrigerant tank is open. • Inlet or outlet of indoor unit are not closed due to a foreign object.
P8 PA	Instruction to perform additional refrigerant charging during check operation (not a malfunction).	Make the check operation by "11-2 Procedure of check operation".
E2, E3	E3 is activated, so On/Off button is pressed on the remote controller, but this does not turn E3 off. Or E2 is activated. In case of above, there is a malfunction of the compressor in the outdoor unit.	Measure the insulation resistance of the compressor to check the condition of the compressor.

If any malfunction codes other than the above are displayed, check the service manual for how to respond.

12. ONSITE SETTINGS

Note

In the case of a multi system, all onsite settings should be made on the master unit. Settings made on sub units are invalid. The outdoor unit to which the indoor unit transmission wire are connected is the master unit, and all other units are sub units.

12-1 Onsite Settings With the Power Off

If the COOL/HEAT selector was connected to the outdoor unit in "7. FIELD WIRING", set the dip switch (DS1) on the outdoor unit PC-board (A1P) to "ON" (it is set to "OFF" when shipped from the factory).

For the position of the dip switch (DS1), see the "Service Precaution" label (see at the figure below) which is attached to the EL. COMPO. BOX lid.

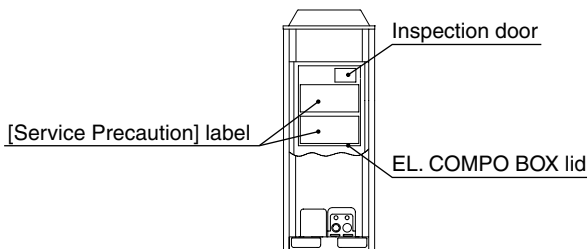

⚠ WARNING ⚡ ELECTRIC SHOCK WARNING

Never perform with the power on. There is a serious risk of electric shock if any live part is touched.

12-2 Onsite Settings With the Power On

Use the push button switches (BS1 through BS5) on the outdoor unit PC-board (A1P) to make the necessary onsite settings.

See the "Service Precaution" label on the EL. CONPO. BOX lid for details on the positions and operating method of the push button switches and on the onsite setting.

Make sure to record the setting on the accessory "REQUEST FOR THE INDICATION" label.

⚠ WARNING ⚡ ELECTRIC SHOCK WARNING

Use an insulated rod to operate the push buttons via the inspection door of EL. COMPO. BOX lid.

There is a risk of electric shock if you touch any live parts, since this operation must be performed with the power on.

13. TEST RUN

13-1 Before test run

- Make sure the following works are completed in accordance with the installation manual.
 - Piping work
 - Wiring work
 - Air tight test
 - Vacuum drying
 - Additional refrigerant charge
- Check that all work for the indoor unit are finished and there are no danger to operate.

13-2 Test Run

After check operation is completed, operate the unit normally and check the following.

- (1) Make sure the indoor and outdoor units are operating normally.
- (2) Operate each indoor unit one by one and make sure the corresponding outdoor unit is also operating.
- (3) Check to see if cold (or hot) air is coming out from the indoor unit.
- (4) Push the fan direction and strength buttons on the remote controller to see if they operate properly.

Note

- Heating is not possible if the outdoor temperature is 24°C or higher. Refer to the Operation manual.
- If a knocking sound can be heard in the liquid compression of the compressor, stop the unit immediately and then energize the crank case heater for a sufficient length of time before restarting the operation.
- Once stopping, the compressor will not restart in about 5 minutes even if the On/Off button of the remote controller is pushed.
- When the system operation is stopped by the remote controller, the outdoor units may continue operating for further 5 minutes at maximum.
- The outdoor unit fan may rotate at low speeds if the Night-time low noise setting or the External low noise level setting is made, but this is not a malfunction.

13-3 Checks After Test Run

Perform the following checks after the test run is complete.

- Record the contents of field setting.
 - Record them on the accessory "REQUEST FOR THE INDICATION" label. And attach the label on the back side of the front panel.
- Record the installation date.
 - Record the installation date on the accessory "REQUEST FOR THE INDICATION" label in accordance with the IEC60335-2-40. And attach the label on the back side of the front panel.

Note

After the test run, when handing the unit over to the customer, make sure the EL.COMPO.BOX lid, the inspection door, and the unit casing are all attached.

14. CAUTION FOR REFRIGERANT LEAKS

(Points to note in connection with refrigerant leaks)

Introduction

The installer and system specialist shall secure safety against leakage according to local regulations or standards. The following standards may be applicable if local regulations are not available.

The VRV System, like other air conditioning systems, uses R410A as refrigerant. R410A itself is an entirely safe non-toxic, non-combustible refrigerant. Nevertheless care must be taken to ensure that air conditioning facilities are installed in a room which is sufficiently large. This assures that the maximum concentration level of refrigerant gas is not exceeded, in the unlikely event of major leak in the system and this in accordance to the local applicable regulations and standards.

Maximum concentration level.

The maximum charge of refrigerant and the calculation of the maximum concentration of refrigerant is directly related to the humanly occupied space in to which it could leak.

The unit of measurement of the concentration is kg/m^3 (the weight in kg of the refrigerant gas in 1m^3 volume of the occupied space).

Compliance to the local applicable regulations and standards for the maximum allowable concentration level is required.

In Australia the maximum allowed concentration level of refrigerant to a humanly space is limited to 0.35kg/m^3 for R407C and 0.44kg/m^3 for R410A.

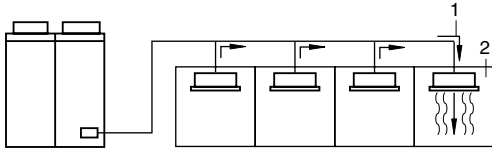

1. Direction of the refrigerant flow
2. Room where refrigerant leak has occurred (outflow of all the refrigerant from the system)

Pay special attention to the place, such as a basement, etc. where refrigerant can stay, since refrigerant is heavier than air.

Procedure for checking maximum concentration.

Check the maximum concentration level in accordance with steps 1 to 4 below and take whatever action is necessary to comply.

1. Calculate the amount of refrigerant (kg) charged to each system separately.

Amount of refrigerant in a single unit system (amount of refrigerant with which the system is charged before leaving the factory)	+	Additional charging amount (amount of refrigerant added locally in accordance with the length or diameter of the refrigerant piping)	=	Total amount of refrigerant (kg) in the system
---	---	--	---	--

Note

- Where a single refrigerant facility is divided into 2 entirely independent refrigerant systems then use the amount of refrigerant with which each separate system is charged.
2. Calculate the smallest room volume (m^3).
In case like the following, calculate the volume of (A), (B) as a single room or as the smallest room.

A. Where there are no smaller room divisions.

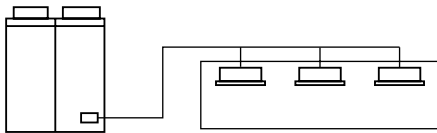

B. Where there is a room division but there is an opening between the rooms sufficiently large to permit a free flow of air back and forth.

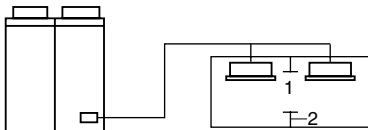

1. Opening between rooms
2. Partition

(Where there is an opening without a door or where there are openings above and below the door which are each equivalent in size to 0.15% or more of the floor area.)

3. Calculating the refrigerant density using the results of the calculations in steps 1 and 2 above.

Total volume of refrigerant in the refrigerant system	\leq	Maximum concentration level (kg/m^3)
Size (m^3) of smallest room in which there is an indoor unit installed		

If the result of the above calculation exceeds the maximum concentration level then make similar calculations for the second then third smallest room and so until the result falls short of the maximum concentration.

4. Dealing with the situations where the result exceeds the maximum concentration level.
Where the installation of a facility results in a concentration in excess of the maximum concentration level then it will be necessary to revise the system. Please consult your Daikin supplier.

DAIKIN INDUSTRIES, LTD.

Head office:

Umeda Center Bldg., 2-4-12, Nakazaki-Nishi,
Kita-ku, Osaka, 530-8323 Japan

Tokyo office:

JR Shinagawa East Bldg., 2-18-1, Konan,
Minato-ku, Tokyo, 108-0075 Japan

DAIKIN EUROPE N.V.

Zandvoordestraat 300, B-8400 Oostende, Belgium