

AIR CONDITIONING SYSTEMS

CITY MULTI



DATA BOOK

MODEL

PURY-P200-1100Y(S)NW-A(-BS)

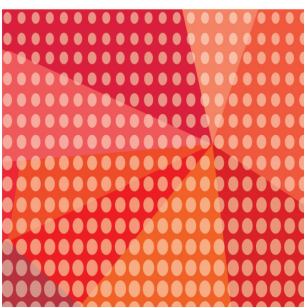

**Line-up of Outdoor Units of R410A CITY MULTI
Heat Recovery R2-Series**



PURY-P200YNW-A(-BS) PURY-P250YNW-A(-BS)
PURY-P300YNW-A(-BS)

8, 10, 12HP



PURY-P350YNW-A(-BS) PURY-P400YNW-A(-BS)
PURY-P450YNW-A(-BS)

14, 16, 18HP



PURY-P500YNW-A(-BS) PURY-P550YNW-A(-BS)

20, 22HP



PURY-P400YSNW-A(-BS) PURY-P450YSNW-A(-BS)
PURY-P500YSNW-A(-BS) PURY-P550YSNW-A(-BS)
PURY-P600YSNW-A(-BS)

16, 18, 20, 22, 24HP



PURY-P650YSNW-A(-BS)

26HP



PURY-P700YSNW-A(-BS) PURY-P750YSNW-A(-BS)
PURY-P800YSNW-A(-BS) PURY-P850YSNW-A(-BS)
PURY-P900YSNW-A(-BS)

28, 30, 32, 34, 36HP



PURY-P950YSNW-A(-BS)

38HP



PURY-P1000YSNW-A(-BS) PURY-P1050YSNW-A(-BS)
PURY-P1100YSNW-A(-BS)

40, 42, 44HP

PURY-P-Y(S)NW-A

1. SPECIFICATIONS	2
2. EXTERNAL DIMENSIONS	25
3. CENTER OF GRAVITY	36
4. ELECTRICAL WIRING DIAGRAMS	37
5. SOUND LEVELS	40
5-1. Sound levels in cooling mode	40
5-2. Sound levels in heating mode	47
6. VIBRATION LEVEL	54
7. OPERATION TEMPERATURE RANGE	55
8. CAPACITY TABLES	56
8-1. Selection of Cooling/Heating Units	56
8-2. Correction by temperature	62
8-3. Correction by total indoor	98
8-4. Correction by refrigerant piping length	110
8-5. Correction by port counts of the BC controller	114
8-6. Correction at frost and defrost	114
8-7. Correction at evaporation-temperature (ET) control	114
9. OPTIONAL PARTS	115
9-1. JOINT and REDUCER	115
9-2. OUTDOOR TWINNING KIT	119
9-3. JOINT KIT "CMY-R160-J1" FOR BC CONTROLLER	120
9-4. FIN GUARD	121
10. ELECTRICAL WORK	123
10-1. General cautions	123
10-2. Power supply for Outdoor unit	124
10-3. Power cable specifications	125
10-4. Power supply examples	126
11. M-NET CONTROL	128
11-1. Transmission cable length limitation	128
11-2. Transmission cable specifications	129
11-3. System configuration restrictions	130
11-4. Address setting	134
12. PIPING DESIGN	146
12-1. R410A Piping material	147
12-2. Piping Design	149
12-3. Refrigerant charging calculation	155
13. OUTDOOR INSTALLATION	157
13-1. Requirement on installation site	157
13-2. Spacing	158
13-3. Piping direction	160
13-4. Countermeasure to wind	165
13-5. Precautions for installing a panel heater	165

1. SPECIFICATIONS

Outdoor units

Model			PURY-P200YNW-A (-BS)			
Power source			3-phase 4-wire 380-400-415 V 50/60 Hz			
Cooling capacity (Nominal)	*1	kW	22.4			
		kcal/h	20,000			
		BTU/h	76,400			
	Power input	kW	4.43			
	Current input	A	7.4-7.1-6.8			
EER	kW/kW	5.05				
Temp. range of cooling	Indoor	W.B.	15.0~24.0°C (59~75°F)			
	Outdoor	D.B.	-5.0~52.0°C (23~126°F)			
Heating capacity (Max)	*2	kW	25.0			
		kcal/h	21,500			
		BTU/h	85,300			
	Power input	kW	4.71			
	Current input	A	7.9-7.5-7.2			
	COP	kW/kW	5.30			
	(Nominal)	*3	kW	22.4		
			kcal/h	20,000		
			BTU/h	76,400		
		Power input	kW	4.14		
Current input	A	6.9-6.6-6.3				
COP	kW/kW	5.41				
Temp. range of heating	Indoor	D.B.	15.0~27.0°C (59~81°F)			
	Outdoor	W.B.	-20.0~15.5°C (-4~60°F)			
Indoor unit connectable	Total capacity	50~150%				
	Model/Quantity	P15-P250/1~20				
Sound pressure level (measured in anechoic room) *4	dB <A>	59.0/59.0				
Sound power level (measured in anechoic room) *4	dB <A>	76.0/78.0				
Refrigerant piping diameter	High pressure	mm (in.)	15.88 (5/8) Brazed			
	Low pressure	mm (in.)	19.05 (3/4) Brazed			
FAN	Type x Quantity		Propeller fan x 1			
	Air flow rate	m ³ /min	170			
		L/s	2,833			
		cfm	6,003			
	Control, Driving mechanism		Inverter-control, Direct-driven by motor			
	Motor output	kW	0.92 x 1			
*5 External static press.	0 Pa (0 mmH ₂ O)					
Compressor	Type	Inverter scroll hermetic compressor				
	Manufacture	AC&R Works, MITSUBISHI ELECTRIC CORPORATION				
	Starting method	Inverter				
	Motor output	kW	5.6			
	Case heater	kW	-			
Lubricant	MEL32					
External finish			Pre-coated galvanized steel sheets (+powder coating for -BS type) <MUNSELL 5Y 8/1 or similar>			
External dimension H x W x D		mm	1,858 (1,798 without legs) x 920 x 740			
		in.	73-3/16 (70-13/16 without legs) x 36-1/4 x 29-3/16			
Protection devices	High pressure protection		High pressure sensor, High pressure switch at 4.15 MPa (601 psi)			
	Inverter circuit (COMP./FAN)		Over-heat protection, Over-current protection			
	Compressor		-			
	Fan motor		-			
Refrigerant	Type x original charge		R410A x 5.2 kg (12 lbs)			
	Control		Indoor LEV and BC controller			
Net weight		kg (lbs)	229 (505)			
Heat exchanger			Salt-resistant cross fin & copper tube			
HIC circuit (HIC: Heat Inter-Changer)			-			
Defrosting method			Auto-defrost mode (Reversed refrigerant cycle)			
Drawing	External		WKS94T748			
	Wiring		WKE94G339			
Standard attachment	Document		Installation Manual			
	Accessory		-			
Optional parts			Joint: CMY-Y102SS-G2, CMY-Y102LS-G2, CMY-R160-J1 BC controller: CMB-P104, 106, 108, 1012, 1016V-J Main BC controller: CMB-P108, 1012, 1016V-JA, CMB-P1016V-KA Sub BC controller: CMB-P104, 108V-KB			
Remarks			Details on foundation work, duct work, insulation work, electrical wiring, power source switch, and other items shall be referred to the Installation Manual. Due to continuing improvement, above specifications may be subject to change without notice.			

Notes:	Unit converter
1. Nominal cooling conditions (subject to JIS B8615-2) Indoor: 27°C D.B./19°C W.B. (81°F D.B./66°F W.B.), Outdoor: 35°C D.B./24°C W.B. (95°F D.B./75°F W.B.) Pipe length: 7.5 m (24-9/16 ft.), Level difference: 0 m (0 ft.)	BTU/h = kW x 3,412
2. Nominal heating conditions (subject to JIS B8615-2) Indoor: 20°C D.B. (68°F D.B.), Outdoor: 7°C D.B./6°C W.B. (45°F D.B./43°F W.B.) Pipe length: 7.5 m (24-9/16 ft.), Level difference: 0 m (0 ft.)	cfm = m ³ /min x 35.31
3. Nominal heating conditions (subject to JIS B8615-2) Indoor: 20°C D.B. (68°F D.B.), Outdoor: 7°C D.B./6°C W.B. (45°F D.B./43°F W.B.) Pipe length: 7.5 m (24-9/16 ft.), Level difference: 0 m (0 ft.) Eurovent registered	lbs = kg/0.4536
4. Cooling mode/Heating mode	
5. External static pressure option is available (30 Pa, 60 Pa, 80 Pa/3.1 mmH ₂ O, 6.1 mmH ₂ O, 8.2 mmH ₂ O). Consult your dealer about the specification when setting External static pressure option.	*Above specification data is subject to rounding variation.

1. SPECIFICATIONS

Outdoor units

Model		PURY-P250YNW-A (-BS)		
Power source		3-phase 4-wire 380-400-415 V 50/60 Hz		
Cooling capacity (Nominal)	*1 kW	28.0		
	kcal/h	25,000		
	BTU/h	95,500		
	Power input kW	5.97		
	Current input A	10.0-9.5-9.2		
EER	kW/kW	4.69		
Temp. range of cooling	Indoor	W.B.	15.0~24.0°C (59~75°F)	
	Outdoor	D.B.	-5.0~52.0°C (23~126°F)	
Heating capacity (Max)	*2 kW	31.5		
	kcal/h	27,100		
	BTU/h	107,500		
	Power input kW	6.06		
	Current input A	10.2-9.7-9.3		
	COP	kW/kW	5.19	
	(Nominal)	*3 kW	28.0	
		kcal/h	25,000	
		BTU/h	95,500	
		Power input kW	5.27	
Current input A		8.8-8.4-8.1		
COP	kW/kW	5.31		
Temp. range of heating	Indoor	D.B.	15.0~27.0°C (59~81°F)	
	Outdoor	W.B.	-20.0~15.5°C (-4~60°F)	
Indoor unit connectable	Total capacity	50~150%		
	Model/Quantity	P15~P250/1~25		
Sound pressure level (measured in anechoic room) *4	dB <A>	60.5/61.0		
Sound power level (measured in anechoic room) *4	dB <A>	78.5/80.0		
Refrigerant piping diameter	High pressure	mm (in.)	19.05 (3/4) Brazed	
	Low pressure	mm (in.)	22.2 (7/8) Brazed	
FAN	Type x Quantity		Propeller fan x 1	
	Air flow rate	m ³ /min	185	
		L/s	3,083	
		cfm	6,532	
	Control, Driving mechanism		Inverter-control, Direct-driven by motor	
	Motor output	kW	0.92 x 1	
*5 External static press.	0 Pa (0 mmH ₂ O)			
Compressor	Type	Inverter scroll hermetic compressor		
	Manufacture	AC&R Works, MITSUBISHI ELECTRIC CORPORATION		
	Starting method	Inverter		
	Motor output	kW	7.0	
	Case heater	kW	-	
Lubricant	MEL32			
External finish		Pre-coated galvanized steel sheets (+powder coating for -BS type) <MUNSELL 5Y 8/1 or similar>		
External dimension H x W x D		mm	1,858 (1,798 without legs) x 920 x 740	
		in.	73-3/16 (70-13/16 without legs) x 36-1/4 x 29-3/16	
Protection devices	High pressure protection		High pressure sensor, High pressure switch at 4.15 MPa (601 psi)	
	Inverter circuit (COMP./FAN)		Over-heat protection, Over-current protection	
	Compressor		-	
	Fan motor		-	
Refrigerant	Type x original charge		R410A x 5.2 kg (12 lbs)	
	Control		Indoor LEV and BC controller	
Net weight	kg (lbs)	229 (505)		
Heat exchanger		Salt-resistant cross fin & copper tube		
HIC circuit (HIC: Heat Inter-Changer)		-		
Defrosting method		Auto-defrost mode (Reversed refrigerant cycle)		
Drawing	External		WKS94T748	
	Wiring		WKE94G339	
Standard attachment	Document		Installation Manual	
	Accessory		-	
Optional parts		Joint: CMY-Y102SS-G2, CMY-Y102LS-G2, CMY-R160-J1 BC controller: CMB-P104, 106, 108, 1012, 1016V-J Main BC controller: CMB-P108, 1012, 1016V-JA, CMB-P1016V-KA Sub BC controller: CMB-P104, 108V-KB		
Remarks		Details on foundation work, duct work, insulation work, electrical wiring, power source switch, and other items shall be referred to the Installation Manual. Due to continuing improvement, above specifications may be subject to change without notice.		

Notes:	Unit converter
1. Nominal cooling conditions (subject to JIS B8615-2) Indoor: 27°C D.B./19°C W.B. (81°F D.B./66°F W.B.), Outdoor: 35°C D.B./24°C W.B. (95°F D.B./75°F W.B.) Pipe length: 7.5 m (24-9/16 ft.), Level difference: 0 m (0 ft.)	BTU/h = kW x 3.412
2. Nominal heating conditions (subject to JIS B8615-2) Indoor: 20°C D.B. (68°F D.B.), Outdoor: 7°C D.B./6°C W.B. (45°F D.B./43°F W.B.) Pipe length: 7.5 m (24-9/16 ft.), Level difference: 0 m (0 ft.)	cfm = m ³ /min x 35.31
3. Nominal heating conditions (subject to JIS B8615-2) Indoor: 20°C D.B. (68°F D.B.), Outdoor: 7°C D.B./6°C W.B. (45°F D.B./43°F W.B.) Pipe length: 7.5 m (24-9/16 ft.), Level difference: 0 m (0 ft.) Eurovent registered	lbs = kg/0.4536
4. Cooling mode/Heating mode	
5. External static pressure option is available (30 Pa, 60 Pa, 80 Pa/3.1 mmH ₂ O, 6.1 mmH ₂ O, 8.2 mmH ₂ O). Consult your dealer about the specification when setting External static pressure option.	*Above specification data is subject to rounding variation.

1. SPECIFICATIONS

Outdoor units

Model			PURY-P300YNW-A (-BS)			
Power source			3-phase 4-wire 380-400-415 V 50/60 Hz			
Cooling capacity (Nominal)	*1	kW	33.5			
		kcal/h	30,000			
		BTU/h	114,300			
	Power input	kW	7.54			
	Current input	A	12.7-12.0-11.6			
EER	kW/kW	4.44				
Temp. range of cooling	Indoor	W.B.	15.0~24.0°C (59~75°F)			
	Outdoor	D.B.	-5.0~52.0°C (23~126°F)			
Heating capacity (Max)	*2	kW	37.5			
		kcal/h	32,300			
		BTU/h	128,000			
	Power input	kW	8.38			
	Current input	A	14.1-13.4-12.9			
	COP	kW/kW	4.47			
	(Nominal)	*3	kW	33.5		
			kcal/h	30,000		
			BTU/h	114,300		
		Power input	kW	6.80		
Current input	A	11.4-10.9-10.5				
COP	kW/kW	4.92				
Temp. range of heating	Indoor	D.B.	15.0~27.0°C (59~81°F)			
	Outdoor	W.B.	-20.0~15.5°C (-4~60°F)			
Indoor unit connectable	Total capacity	50~150%				
	Model/Quantity	P15-P250/1~30				
Sound pressure level (measured in anechoic room) *4	dB <A>	61.0/67.0				
Sound power level (measured in anechoic room) *4	dB <A>	80.0/86.5				
Refrigerant piping diameter	High pressure	mm (in.)	19.05 (3/4) Brazed			
	Low pressure	mm (in.)	22.2 (7/8) Brazed			
FAN	Type x Quantity		Propeller fan x 1			
	Air flow rate	m ³ /min	240			
		L/s	4,000			
		cfm	8,474			
	Control, Driving mechanism		Inverter-control, Direct-driven by motor			
	Motor output	kW	0.92 x 1			
*5 External static press.	0 Pa (0 mmH ₂ O)					
Compressor	Type	Inverter scroll hermetic compressor				
	Manufacture	AC&R Works, MITSUBISHI ELECTRIC CORPORATION				
	Starting method	Inverter				
	Motor output	kW	7.9			
	Case heater	kW	-			
Lubricant	MEL32					
External finish			Pre-coated galvanized steel sheets (+powder coating for -BS type) <MUNSELL 5Y 8/1 or similar>			
External dimension H x W x D		mm	1,858 (1,798 without legs) x 920 x 740			
		in.	73-3/16 (70-13/16 without legs) x 36-1/4 x 29-3/16			
Protection devices	High pressure protection		High pressure sensor, High pressure switch at 4.15 MPa (601 psi)			
	Inverter circuit (COMP./FAN)		Over-heat protection, Over-current protection			
	Compressor		-			
	Fan motor		-			
Refrigerant	Type x original charge		R410A x 5.2 kg (12 lbs)			
	Control		Indoor LEV and BC controller			
Net weight		kg (lbs)	231 (510)			
Heat exchanger			Salt-resistant cross fin & copper tube			
HIC circuit (HIC: Heat Inter-Changer)			-			
Defrosting method			Auto-defrost mode (Reversed refrigerant cycle)			
Drawing	External		WKS94T748			
	Wiring		WKE94G339			
Standard attachment	Document		Installation Manual			
	Accessory		-			
Optional parts			Joint: CMY-Y102SS-G2, CMY-Y102LS-G2, CMY-R160-J1 BC controller: CMB-P104, 106, 108, 1012, 1016V-J Main BC controller: CMB-P108, 1012, 1016V-JA, CMB-P1016V-KA Sub BC controller: CMB-P104, 108V-KB			
Remarks			Details on foundation work, duct work, insulation work, electrical wiring, power source switch, and other items shall be referred to the Installation Manual. Due to continuing improvement, above specifications may be subject to change without notice.			

Notes:	Unit converter
1. Nominal cooling conditions (subject to JIS B8615-2) Indoor: 27°C D.B./19°C W.B. (81°F D.B./66°F W.B.), Outdoor: 35°C D.B./24°C W.B. (95°F D.B./75°F W.B.) Pipe length: 7.5 m (24-9/16 ft.), Level difference: 0 m (0 ft.)	BTU/h = kW x 3,412
2. Nominal heating conditions (subject to JIS B8615-2) Indoor: 20°C D.B. (68°F D.B.), Outdoor: 7°C D.B./6°C W.B. (45°F D.B./43°F W.B.) Pipe length: 7.5 m (24-9/16 ft.), Level difference: 0 m (0 ft.)	cfm = m ³ /min x 35.31
3. Nominal heating conditions (subject to JIS B8615-2) Indoor: 20°C D.B. (68°F D.B.), Outdoor: 7°C D.B./6°C W.B. (45°F D.B./43°F W.B.) Pipe length: 7.5 m (24-9/16 ft.), Level difference: 0 m (0 ft.) Eurovent registered	lbs = kg/0.4536
4. Cooling mode/Heating mode	
5. External static pressure option is available (30 Pa, 60 Pa, 80 Pa/3.1 mmH ₂ O, 6.1 mmH ₂ O, 8.2 mmH ₂ O). Consult your dealer about the specification when setting External static pressure option.	*Above specification data is subject to rounding variation.

1. SPECIFICATIONS

Outdoor units

Model		PURY-P350YNW-A (-BS)		
Power source		3-phase 4-wire 380-400-415 V 50/60 Hz		
Cooling capacity (Nominal)	*1	kW	40.0	
		kcal/h	35,000	
		BTU/h	136,500	
	Power input	kW	10.04	
	Current input	A	16.9-16.1-15.5	
EER		kW/kW	3.98	
Temp. range of cooling	Indoor	W.B.	15.0~24.0°C (59~75°F)	
	Outdoor	D.B.	-5.0~52.0°C (23~126°F)	
Heating capacity (Max)	*2	kW	45.0	
		kcal/h	38,700	
		BTU/h	153,500	
	Power input	kW	10.68	
	Current input	A	18.0-17.1-16.5	
	COP		kW/kW	4.21
	(Nominal)	*3	kW	40.0
			kcal/h	35,000
			BTU/h	136,500
		Power input	kW	8.84
Current input	A	14.9-14.1-13.6		
COP		kW/kW	4.52	
Temp. range of heating	Indoor	D.B.	15.0~27.0°C (59~81°F)	
	Outdoor	W.B.	-20.0~15.5°C (-4~60°F)	
Indoor unit connectable	Total capacity		50~150%	
	Model/Quantity		P15~P250/1~35	
Sound pressure level (measured in anechoic room) *4		dB <A>	62.5/64.0	
Sound power level (measured in anechoic room) *4		dB <A>	81.0/83.0	
Refrigerant piping diameter	High pressure	mm (in.)	19.05 (3/4) Brazed	
	Low pressure	mm (in.)	28.58 (1-1/8) Brazed	
FAN	Type x Quantity		Propeller fan x 2	
	Air flow rate	m ³ /min	250	
		L/s	4,167	
		cfm	8,828	
	Control, Driving mechanism		Inverter-control, Direct-driven by motor	
	Motor output	kW	0.46 x 2	
*5	External static press.		0 Pa (0 mmH ₂ O)	
Compressor	Type		Inverter scroll hermetic compressor	
	Manufacture		AC&R Works, MITSUBISHI ELECTRIC CORPORATION	
	Starting method		Inverter	
	Motor output	kW	10.2	
	Case heater	kW	-	
Lubricant		MEL32		
External finish		Pre-coated galvanized steel sheets (+powder coating for -BS type) <MUNSELL 5Y 8/1 or similar>		
External dimension H x W x D		mm	1,858 (1,798 without legs) x 1,240 x 740	
		in.	73-3/16 (70-13/16 without legs) x 48-7/8 x 29-3/16	
Protection devices	High pressure protection		High pressure sensor, High pressure switch at 4.15 MPa (601 psi)	
	Inverter circuit (COMP./FAN)		Over-heat protection, Over-current protection	
	Compressor		-	
	Fan motor		-	
Refrigerant	Type x original charge		R410A x 8.0 kg (18 lbs)	
	Control		Indoor LEV and BC controller	
Net weight		kg (lbs)	273 (602)	
Heat exchanger		Salt-resistant cross fin & copper tube		
HIC circuit (HIC: Heat Inter-Changer)		-		
Defrosting method		Auto-defrost mode (Reversed refrigerant cycle)		
Drawing	External		WKS94T749	
	Wiring		WKE94G341	
Standard attachment	Document		Installation Manual	
	Accessory		-	
Optional parts		Joint: CMY-Y102SS-G2, CMY-Y102LS-G2, CMY-R160-J1 BC controller: CMB-P104, 106, 108, 1012, 1016V-J Main BC controller: CMB-P108, 1012, 1016V-JA, CMB-P1016V-KA Sub BC controller: CMB-P104, 108V-KB		
Remarks		Details on foundation work, duct work, insulation work, electrical wiring, power source switch, and other items shall be referred to the Installation Manual. Due to continuing improvement, above specifications may be subject to change without notice.		

Notes:	Unit converter
1. Nominal cooling conditions (subject to JIS B8615-2) Indoor: 27°C D.B./19°C W.B. (81°F D.B./66°F W.B.), Outdoor: 35°C D.B./24°C W.B. (95°F D.B./75°F W.B.) Pipe length: 7.5 m (24-9/16 ft.), Level difference: 0 m (0 ft.)	BTU/h = kW x 3.412
2. Nominal heating conditions (subject to JIS B8615-2) Indoor: 20°C D.B. (68°F D.B.), Outdoor: 7°C D.B./6°C W.B. (45°F D.B./43°F W.B.) Pipe length: 7.5 m (24-9/16 ft.), Level difference: 0 m (0 ft.)	cfm = m ³ /min x 35.31
3. Nominal heating conditions (subject to JIS B8615-2) Indoor: 20°C D.B. (68°F D.B.), Outdoor: 7°C D.B./6°C W.B. (45°F D.B./43°F W.B.) Pipe length: 7.5 m (24-9/16 ft.), Level difference: 0 m (0 ft.) Eurovent registered	lbs = kg/0.4536
4. Cooling mode/Heating mode	
5. External static pressure option is available (30 Pa, 60 Pa, 80 Pa/3.1 mmH ₂ O, 6.1 mmH ₂ O, 8.2 mmH ₂ O). Consult your dealer about the specification when setting External static pressure option.	*Above specification data is subject to rounding variation.

1. SPECIFICATIONS

Outdoor units

Model			PURY-P400YNW-A (-BS)		
Power source			3-phase 4-wire 380-400-415 V 50/60 Hz		
Cooling capacity (Nominal)	*1	kW	45.0		
		kcal/h	40,000		
		BTU/h	153,500		
	Power input	kW	11.59		
	Current input	A	19.5-18.5-17.9		
EER	kW/kW	3.88			
Temp. range of cooling	Indoor	W.B.	15.0~24.0°C (59~75°F)		
	Outdoor	D.B.	-5.0~52.0°C (23~126°F)		
Heating capacity (Max)	*2	kW	50.0		
		kcal/h	45,000		
		BTU/h	170,600		
	Power input	kW	13.65		
	Current input	A	23.0-21.8-21.0		
	COP	kW/kW	3.66		
	(Nominal)	*3	kW	45.0	
			kcal/h	40,000	
			BTU/h	153,500	
		Power input	kW	10.29	
Current input	A	17.3-16.5-15.9			
COP	kW/kW	4.37			
Temp. range of heating	Indoor	D.B.	15.0~27.0°C (59~81°F)		
	Outdoor	W.B.	-20.0~15.5°C (-4~60°F)		
Indoor unit connectable	Total capacity	50~150%			
	Model/Quantity	P15~P250/1~40			
Sound pressure level (measured in anechoic room) *4	dB <A>	65.0/69.0			
Sound power level (measured in anechoic room) *4	dB <A>	83.0/88.0			
Refrigerant piping diameter	High pressure	mm (in.)	22.2 (7/8) Brazed		
	Low pressure	mm (in.)	28.58 (1-1/8) Brazed		
FAN	Type x Quantity		Propeller fan x 2		
	Air flow rate	m ³ /min	315		
		L/s	5,250		
		cfm	11,123		
	Control, Driving mechanism		Inverter-control, Direct-driven by motor		
	Motor output	kW	0.46 x 2		
*5 External static press.	0 Pa (0 mmH ₂ O)				
Compressor	Type	Inverter scroll hermetic compressor			
	Manufacture	AC&R Works, MITSUBISHI ELECTRIC CORPORATION			
	Starting method	Inverter			
	Motor output	kW	10.9		
	Case heater	kW	-		
Lubricant	MEL32				
External finish			Pre-coated galvanized steel sheets (+powder coating for -BS type) <MUNSELL 5Y 8/1 or similar>		
External dimension H x W x D		mm	1,858 (1,798 without legs) x 1,240 x 740		
		in.	73-3/16 (70-13/16 without legs) x 48-7/8 x 29-3/16		
Protection devices	High pressure protection		High pressure sensor, High pressure switch at 4.15 MPa (601 psi)		
	Inverter circuit (COMP./FAN)		Over-heat protection, Over-current protection		
	Compressor		-		
	Fan motor		-		
Refrigerant	Type x original charge		R410A x 8.0 kg (18 lbs)		
	Control		Indoor LEV and BC controller		
Net weight		kg (lbs)	273 (602)		
Heat exchanger			Salt-resistant cross fin & copper tube		
HIC circuit (HIC: Heat Inter-Changer)			-		
Defrosting method			Auto-defrost mode (Reversed refrigerant cycle)		
Drawing	External	WKS94T749			
	Wiring	WKE94G341			
Standard attachment	Document	Installation Manual			
	Accessory	-			
Optional parts			Joint: CMY-Y102SS-G2, CMY-Y102LS-G2, CMY-R160-J1 Main BC controller: CMB-P108, 1012, 1016V-JA, CMB-P1016V-KA Sub BC controller: CMB-P104, 108V-KB		
Remarks			Details on foundation work, duct work, insulation work, electrical wiring, power source switch, and other items shall be referred to the Installation Manual. Due to continuing improvement, above specifications may be subject to change without notice.		

Notes:	Unit converter
1. Nominal cooling conditions (subject to JIS B8615-2) Indoor: 27°C D.B./19°C W.B. (81°F D.B./66°F W.B.), Outdoor: 35°C D.B./24°C W.B. (95°F D.B./75°F W.B.) Pipe length: 7.5 m (24-9/16 ft.), Level difference: 0 m (0 ft.)	BTU/h = kW x 3,412
2. Nominal heating conditions (subject to JIS B8615-2) Indoor: 20°C D.B. (68°F D.B.), Outdoor: 7°C D.B./6°C W.B. (45°F D.B./43°F W.B.) Pipe length: 7.5 m (24-9/16 ft.), Level difference: 0 m (0 ft.)	cfm = m ³ /min x 35.31
3. Nominal heating conditions (subject to JIS B8615-2) Indoor: 20°C D.B. (68°F D.B.), Outdoor: 7°C D.B./6°C W.B. (45°F D.B./43°F W.B.) Pipe length: 7.5 m (24-9/16 ft.), Level difference: 0 m (0 ft.) Eurovent registered	lbs = kg/0.4536
4. Cooling mode/Heating mode	
5. External static pressure option is available (30 Pa, 60 Pa, 80 Pa/3.1 mmH ₂ O, 6.1 mmH ₂ O, 8.2 mmH ₂ O). Consult your dealer about the specification when setting External static pressure option.	*Above specification data is subject to rounding variation.

1. SPECIFICATIONS

Outdoor units

Model		PURY-P450YNW-A (-BS)		
Power source		3-phase 4-wire 380-400-415 V 50/60 Hz		
Cooling capacity (Nominal)	*1 kW	50.0		
	kcal/h	45,000		
	BTU/h	170,600		
	Power input kW	12.37		
	Current input A	20.8-19.8-19.1		
	EER	4.04		
Temp. range of cooling	Indoor	W.B.	15.0~24.0°C (59~75°F)	
	Outdoor	D.B.	-5.0~52.0°C (23~126°F)	
Heating capacity (Max)	*2 kW	56.0		
	kcal/h	50,000		
	BTU/h	191,100		
	Power input kW	13.48		
	Current input A	22.7-21.6-20.8		
	COP	4.15		
	(Nominal)	*3 kW	50.0	
		kcal/h	45,000	
		BTU/h	170,600	
		Power input kW	10.91	
Current input A	18.4-17.4-16.8			
COP	4.58			
Temp. range of heating	Indoor	D.B.	15.0~27.0°C (59~81°F)	
	Outdoor	W.B.	-20.0~15.5°C (-4~60°F)	
Indoor unit connectable	Total capacity	50~150%		
	Model/Quantity	P15~P250/1~45		
Sound pressure level (measured in anechoic room) *4	dB <A>	65.5/70.0		
Sound power level (measured in anechoic room) *4	dB <A>	83.0/89.0		
Refrigerant piping diameter	High pressure	mm (in.)	22.2 (7/8) Brazed	
	Low pressure	mm (in.)	28.58 (1-1/8) Brazed	
FAN	Type x Quantity		Propeller fan x 2	
	Air flow rate	m ³ /min	315	
		L/s	5,250	
		cfm	11,123	
	Control, Driving mechanism		Inverter-control, Direct-driven by motor	
	Motor output	kW	0.46 x 2	
*5 External static press.	0 Pa (0 mmH ₂ O)			
Compressor	Type	Inverter scroll hermetic compressor		
	Manufacture	AC&R Works, MITSUBISHI ELECTRIC CORPORATION		
	Starting method	Inverter		
	Motor output	kW	12.4	
	Case heater	kW	-	
Lubricant	MEL32			
External finish		Pre-coated galvanized steel sheets (+powder coating for -BS type) <MUNSELL 5Y 8/1 or similar>		
External dimension H x W x D		mm	1,858 (1,798 without legs) x 1,240 x 740	
		in.	73-3/16 (70-13/16 without legs) x 48-7/8 x 29-3/16	
Protection devices	High pressure protection		High pressure sensor, High pressure switch at 4.15 MPa (601 psi)	
	Inverter circuit (COMP./FAN)		Over-heat protection, Over-current protection	
	Compressor		-	
	Fan motor		-	
Refrigerant	Type x original charge		R410A x 10.8 kg (24 lbs)	
	Control		Indoor LEV and BC controller	
Net weight	kg (lbs)	293 (646)		
Heat exchanger		Salt-resistant cross fin & copper tube		
HIC circuit (HIC: Heat Inter-Changer)		-		
Defrosting method		Auto-defrost mode (Reversed refrigerant cycle)		
Drawing	External		WKS94T749	
	Wiring		WKE94G341	
Standard attachment	Document		Installation Manual	
	Accessory		-	
Optional parts		Joint: CMY-Y102SS-G2, CMY-Y102LS-G2, CMY-R160-J1 Main BC controller: CMB-P108, 1012, 1016V-JA, CMB-P1016V-KA Sub BC controller: CMB-P104, 108V-KB		
Remarks		Details on foundation work, duct work, insulation work, electrical wiring, power source switch, and other items shall be referred to the Installation Manual. Due to continuing improvement, above specifications may be subject to change without notice.		

Notes:	Unit converter
1. Nominal cooling conditions (subject to JIS B8615-2) Indoor: 27°C D.B./19°C W.B. (81°F D.B./66°F W.B.), Outdoor: 35°C D.B./24°C W.B. (95°F D.B./75°F W.B.) Pipe length: 7.5 m (24-9/16 ft.), Level difference: 0 m (0 ft.)	BTU/h = kW x 3.412
2. Nominal heating conditions (subject to JIS B8615-2) Indoor: 20°C D.B. (68°F D.B.), Outdoor: 7°C D.B./6°C W.B. (45°F D.B./43°F W.B.) Pipe length: 7.5 m (24-9/16 ft.), Level difference: 0 m (0 ft.)	cfm = m ³ /min x 35.31
3. Nominal heating conditions (subject to JIS B8615-2) Indoor: 20°C D.B. (68°F D.B.), Outdoor: 7°C D.B./6°C W.B. (45°F D.B./43°F W.B.) Pipe length: 7.5 m (24-9/16 ft.), Level difference: 0 m (0 ft.) Eurovent registered	lbs = kg/0.4536
4. Cooling mode/Heating mode	
5. External static pressure option is available (30 Pa, 60 Pa, 80 Pa/3.1 mmH ₂ O, 6.1 mmH ₂ O, 8.2 mmH ₂ O). Consult your dealer about the specification when setting External static pressure option.	*Above specification data is subject to rounding variation.

1. SPECIFICATIONS

Outdoor units

Model			PURY-P500YNW-A (-BS)			
Power source			3-phase 4-wire 380-400-415 V 50/60 Hz			
Cooling capacity (Nominal)	*1	kW	56.0			
		kcal/h	50,000			
		BTU/h	191,100			
	Power input	kW	12.72			
	Current input	A	21.4-20.3-19.6			
EER	kW/kW	4.40				
Temp. range of cooling	Indoor	W.B.	15.0~24.0°C (59~75°F)			
	Outdoor	D.B.	-5.0~52.0°C (23~126°F)			
Heating capacity (Max)	*2	kW	63.0			
		kcal/h	54,200			
		BTU/h	215,000			
	Power input	kW	15.28			
	Current input	A	25.7-24.5-23.6			
	COP	kW/kW	4.12			
	(Nominal)	*3	kW	56.0		
			kcal/h	50,000		
			BTU/h	191,100		
		Power input	kW	12.09		
Current input	A	20.4-19.3-18.6				
COP	kW/kW	4.63				
Temp. range of heating	Indoor	D.B.	15.0~27.0°C (59~81°F)			
	Outdoor	W.B.	-20.0~15.5°C (-4~60°F)			
Indoor unit connectable	Total capacity	50~150%				
	Model/Quantity	P15-P250/1~50				
Sound pressure level (measured in anechoic room) *4	dB <A>	63.5/64.5				
Sound power level (measured in anechoic room) *4	dB <A>	82.0/84.0				
Refrigerant piping diameter	High pressure	mm (in.)	22.2 (7/8) Brazed			
	Low pressure	mm (in.)	28.58 (1-1/8) Brazed			
FAN	Type x Quantity		Propeller fan x 2			
	Air flow rate	m ³ /min	295			
		L/s	4,917			
		cfm	10,416			
	Control, Driving mechanism		Inverter-control, Direct-driven by motor			
	Motor output	kW	0.92 x 2			
*5 External static press.	0 Pa (0 mmH ₂ O)					
Compressor	Type	Inverter scroll hermetic compressor				
	Manufacture	AC&R Works, MITSUBISHI ELECTRIC CORPORATION				
	Starting method	Inverter				
	Motor output	kW	13.0			
	Case heater	kW	-			
	Lubricant	MEL32				
External finish			Pre-coated galvanized steel sheets (+powder coating for -BS type) <MUNSELL 5Y 8/1 or similar>			
External dimension H x W x D		mm	1,858 (1,798 without legs) x 1,750 x 740			
		in.	73-3/16 (70-13/16 without legs) x 68-15/16 x 29-3/16			
Protection devices	High pressure protection		High pressure sensor, High pressure switch at 4.15 MPa (601 psi)			
	Inverter circuit (COMP./FAN)		Over-heat protection, Over-current protection			
	Compressor		-			
	Fan motor		-			
Refrigerant	Type x original charge		R410A x 10.8 kg (24 lbs)			
	Control		Indoor LEV and BC controller			
Net weight	kg (lbs)	337 (743)				
Heat exchanger			Salt-resistant cross fin & copper tube			
HIC circuit (HIC: Heat Inter-Changer)			-			
Defrosting method			Auto-defrost mode (Reversed refrigerant cycle)			
Drawing	External	WKS94T750				
	Wiring	WKE94G342				
Standard attachment	Document	Installation Manual				
	Accessory	-				
Optional parts			Joint: CMY-Y102SS-G2, CMY-Y102LS-G2, CMY-R160-J1 Main BC controller: CMB-P108, 1012, 1016V-JA, CMB-P1016V-KA Sub BC controller: CMB-P104, 108V-KB			
Remarks			Details on foundation work, duct work, insulation work, electrical wiring, power source switch, and other items shall be referred to the Installation Manual. Due to continuing improvement, above specifications may be subject to change without notice.			

Notes:	Unit converter
1. Nominal cooling conditions (subject to JIS B8615-2) Indoor: 27°C D.B./19°C W.B. (81°F D.B./66°F W.B.), Outdoor: 35°C D.B./24°C W.B. (95°F D.B./75°F W.B.) Pipe length: 7.5 m (24-9/16 ft.), Level difference: 0 m (0 ft.)	BTU/h = kW x 3,412
2. Nominal heating conditions (subject to JIS B8615-2) Indoor: 20°C D.B. (68°F D.B.), Outdoor: 7°C D.B./6°C W.B. (45°F D.B./43°F W.B.) Pipe length: 7.5 m (24-9/16 ft.), Level difference: 0 m (0 ft.)	cfm = m ³ /min x 35.31
3. Nominal heating conditions (subject to JIS B8615-2) Indoor: 20°C D.B. (68°F D.B.), Outdoor: 7°C D.B./6°C W.B. (45°F D.B./43°F W.B.) Pipe length: 7.5 m (24-9/16 ft.), Level difference: 0 m (0 ft.) Eurovent registered	lbs = kg/0.4536
4. Cooling mode/Heating mode	
5. External static pressure option is available (30 Pa, 60 Pa, 80 Pa/3.1 mmH ₂ O, 6.1 mmH ₂ O, 8.2 mmH ₂ O). Consult your dealer about the specification when setting External static pressure option.	*Above specification data is subject to rounding variation.

1. SPECIFICATIONS

Outdoor units

Model			PURY-P550YNW-A (-BS)			
Power source			3-phase 4-wire 380-400-415 V 50/60 Hz			
Cooling capacity (Nominal)	*1	kW	63.0			
		kcal/h	54,200			
		BTU/h	215,000			
	Power input	kW	16.03			
	Current input	A	27.0-25.7-24.7			
Temp. range of cooling	Indoor	W.B.	15.0~24.0°C (59~75°F)			
	Outdoor	D.B.	-5.0~52.0°C (23~126°F)			
Heating capacity (Max)	*2	kW	69.0			
		kcal/h	59,300			
		BTU/h	235,400			
	Power input	kW	17.91			
	Current input	A	30.2-28.7-27.6			
	COP	kW/kW	3.85			
	(Nominal)	*3	kW	63.0		
			kcal/h	54,200		
			BTU/h	215,000		
		Power input	kW	14.44		
Current input	A	24.3-23.1-22.3				
COP	kW/kW	4.36				
Temp. range of heating	Indoor	D.B.	15.0~27.0°C (59~81°F)			
	Outdoor	W.B.	-20.0~15.5°C (-4~60°F)			
Indoor unit connectable	Total capacity		50~150%			
	Model/Quantity		P15~P250/2~50			
Sound pressure level (measured in anechoic room) *4		dB <A>	66.0/70.0			
Sound power level (measured in anechoic room) *4		dB <A>	83.5/89.0			
Refrigerant piping diameter	High pressure	mm (in.)	22.2 (7/8) Brazed (1-1/8 (28.58) Brazed for the part that exceeds 65 m)			
	Low pressure	mm (in.)	28.58 (1-1/8) Brazed			
FAN	Type x Quantity		Propeller fan x 2			
	Air flow rate	m ³ /min	410			
		L/s	6,833			
		cfm	14,477			
	Control, Driving mechanism		Inverter-control, Direct-driven by motor			
	Motor output	kW	0.92 x 2			
	*5 External static press.		0 Pa (0 mmH ₂ O)			
Compressor	Type		Inverter scroll hermetic compressor			
	Manufacture		AC&R Works, MITSUBISHI ELECTRIC CORPORATION			
	Starting method		Inverter			
	Motor output	kW	14.3			
	Case heater	kW	-			
Lubricant		MEL32				
External finish			Pre-coated galvanized steel sheets (+powder coating for -BS type) <MUNSELL 5Y 8/1 or similar>			
External dimension H x W x D		mm	1,858 (1,798 without legs) x 1,750 x 740			
		in.	73-3/16 (70-13/16 without legs) x 68-15/16 x 29-3/16			
Protection devices	High pressure protection		High pressure sensor, High pressure switch at 4.15 MPa (601 psi)			
	Inverter circuit (COMP./FAN)		Over-heat protection, Over-current protection			
	Compressor		-			
Fan motor		-				
Refrigerant	Type x original charge		R410A x 10.8 kg (24 lbs)			
	Control		Indoor LEV and BC controller			
Net weight	kg (lbs)	337 (743)				
Heat exchanger			Salt-resistant cross fin & copper tube			
HIC circuit (HIC: Heat Inter-Changer)			-			
Defrosting method			Auto-defrost mode (Reversed refrigerant cycle)			
Drawing	External		WKS94T750			
	Wiring		WKE94G342			
Standard attachment	Document		Installation Manual			
	Accessory		-			
Optional parts			Joint: CMY-Y102SS-G2, CMY-Y102LS-G2, CMY-R160-J1 Main BC controller: CMB-P108, 1012, 1016V-JA, CMB-P1016V-KA Sub BC controller: CMB-P104, 108V-KB			
Remarks			Details on foundation work, duct work, insulation work, electrical wiring, power source switch, and other items shall be referred to the Installation Manual. Due to continuing improvement, above specifications may be subject to change without notice. When the high pressure piping length is 65 m or less, use 7/8 (22.2) pipe. When the high pressure piping length exceeds 65 m, use 1-1/8 (28.58) pipe until 65 m, use 1-1/8 (28.58) pipe for the part that exceeds 65 m.			

Notes:	Unit converter
1. Nominal cooling conditions (subject to JIS B8615-2) Indoor: 27°C D.B./19°C W.B. (81°F D.B./66°F W.B.), Outdoor: 35°C D.B./24°C W.B. (95°F D.B./75°F W.B.) Pipe length: 7.5 m (24-9/16 ft.), Level difference: 0 m (0 ft.)	BTU/h = kW x 3,412
2. Nominal heating conditions (subject to JIS B8615-2) Indoor: 20°C D.B. (68°F D.B.), Outdoor: 7°C D.B./6°C W.B. (45°F D.B./43°F W.B.) Pipe length: 7.5 m (24-9/16 ft.), Level difference: 0 m (0 ft.)	cfm = m ³ /min x 35.31
3. Nominal heating conditions (subject to JIS B8615-2) Indoor: 20°C D.B. (68°F D.B.), Outdoor: 7°C D.B./6°C W.B. (45°F D.B./43°F W.B.) Pipe length: 7.5 m (24-9/16 ft.), Level difference: 0 m (0 ft.)	lbs = kg/0.4536
4. Eurovent registered Cooling mode/Heating mode	
5. External static pressure option is available (30 Pa, 60 Pa, 80 Pa/3.1 mmH ₂ O, 6.1 mmH ₂ O, 8.2 mmH ₂ O). Consult your dealer about the specification when setting External static pressure option.	*Above specification data is subject to rounding variation.

1. SPECIFICATIONS

Outdoor units

Model			PURY-P400YSNW-A (-BS)	
Power source			3-phase 4-wire 380-400-415 V 50/60 Hz	
Cooling capacity (Nominal)	*1	kW	45.0	
		kcal/h	40,000	
		BTU/h	153,500	
	Power input	kW	9.17	
	Current input	A	15.4-14.7-14.1	
Temp. range of cooling	Indoor	W.B.	15.0~24.0°C (59~75°F)	
	Outdoor	D.B.	-5.0~52.0°C (23~126°F)	
Heating capacity (Max)	*2	kW	50.0	
		kcal/h	43,000	
		BTU/h	170,600	
	Power input	kW	9.72	
	Current input	A	16.4-15.5-15.0	
	COP	kW/kW	5.14	
	(Nominal)	*3	kW	45.0
kcal/h			40,000	
BTU/h			153,500	
Power input		kW	8.58	
Temp. range of heating	Indoor	D.B.	15.0~27.0°C (59~81°F)	
	Outdoor	W.B.	-20.0~15.5°C (-4~60°F)	
Indoor unit connectable	Total capacity	50~150% of outdoor unit capacity		
	Model/Quantity	P15-P250/1~40		
Sound pressure level (measured in anechoic room) *4	dB <A>		62.0/62.0	
Sound power level (measured in anechoic room) *4	dB <A>		79.0/81.0	
Refrigerant piping diameter	High pressure	mm (in.)	22.2 (7/8) Brazed	
	Low pressure	mm (in.)	28.58 (1-1/8) Brazed	

Set Model			PURY-P200YNW-A (-BS)		PURY-P200YNW-A (-BS)	
Model			Propeller fan x 1		Propeller fan x 1	
FAN	Type x Quantity		170		170	
	Air flow rate	m ³ /min	2,833		2,833	
		L/s	6,003		6,003	
		cfm	-		-	
	Control, Driving mechanism	Inverter-control, Direct-driven by motor		Inverter-control, Direct-driven by motor		
*5	Motor output	kW	0.92 x 1		0.92 x 1	
Compressor	External static press.		0 Pa (0 mmH ₂ O)		0 Pa (0 mmH ₂ O)	
	Type	Inverter scroll hermetic compressor		Inverter scroll hermetic compressor		
	Manufacture	AC&R Works, MITSUBISHI ELECTRIC CORPORATION		AC&R Works, MITSUBISHI ELECTRIC CORPORATION		
	Starting method	Inverter		Inverter		
	Motor output	kW	5.6		5.6	
	Case heater	kW	-		-	
	Lubricant	MEL32		MEL32		
External finish			Pre-coated galvanized steel sheets (+powder coating for -BS type) <MUNSELL 5Y 8/1 or similar>		Pre-coated galvanized steel sheets (+powder coating for -BS type) <MUNSELL 5Y 8/1 or similar>	
External dimension H x W x D			mm 1,858 (1,798 without legs) x 920 x 740 73-3/16 (70-13/16 without legs) x 36-1/4 x 29-3/16		mm 1,858 (1,798 without legs) x 920 x 740 73-3/16 (70-13/16 without legs) x 36-1/4 x 29-3/16	
Protection devices	High pressure protection		High pressure sensor, High pressure switch at 4.15 MPa (601 psi)		High pressure sensor, High pressure switch at 4.15 MPa (601 psi)	
	Inverter circuit (COMP./FAN)		Over-heat protection, Over-current protection		Over-heat protection, Over-current protection	
	Compressor		-		-	
	Fan motor		-		-	
Refrigerant	Type x original charge		R410A x 5.2 kg (12 lbs)		R410A x 5.2 kg (12 lbs)	
	Control		Indoor LEV and BC controller			
Net weight			kg (lbs) 229 (505)		kg (lbs) 229 (505)	
Heat exchanger			Salt-resistant cross fin & copper tube			
HIC circuit (HIC: Heat Inter-Changer)			-			
Pipe between unit and distributor	High pressure	mm (in.)	15.88 (5/8) Brazed		15.88 (5/8) Brazed	
	Low pressure	mm (in.)	19.05 (3/4) Brazed		19.05 (3/4) Brazed	
Defrosting method			Auto-defrost mode (Reversed refrigerant cycle)			
Drawing	External	WKS94T751				
	Wiring	WKE94G339		WKE94G339		
Standard attachment	Document	Installation Manual				
	Accessory	-				
Optional parts			Outdoor Twinning kit: CMY-R100VBK4 Joint: CMY-Y102SS-G2, CMY-Y102LS-G2, CMY-R160-J1 Main BC controller: CMB-P108, 1012, 1016V-JA, CMB-P1016V-KA Sub BC controller: CMB-P104, 108V-KB			
Remarks			Details on foundation work, duct work, insulation work, electrical wiring, power source switch, and other items shall be referred to the Installation Manual. Due to continuing improvement, above specifications may be subject to change without notice.			

Notes:	Unit converter
1. Nominal cooling conditions (subject to JIS B8615-2) Indoor: 27°C D.B./19°C W.B. (81°F D.B./66°F W.B.), Outdoor: 35°C D.B./24°C W.B. (95°F D.B./75°F W.B.) Pipe length: 7.5 m (24-9/16 ft.), Level difference: 0 m (0 ft.)	BTU/h =kW x 3,412
2. Nominal heating conditions (subject to JIS B8615-2) Indoor: 20°C D.B. (68°F D.B.), Outdoor: 7°C D.B./6°C W.B. (45°F D.B./43°F W.B.) Pipe length: 7.5 m (24-9/16 ft.), Level difference: 0 m (0 ft.)	cfm =m ³ /min x 35.31
3. Nominal heating conditions (subject to JIS B8615-2) Indoor: 20°C D.B. (68°F D.B.), Outdoor: 7°C D.B./6°C W.B. (45°F D.B./43°F W.B.) Pipe length: 7.5 m (24-9/16 ft.), Level difference: 0 m (0 ft.) Eurovent registered	lbs =kg/0.4536
4. Cooling mode/Heating mode	
5. External static pressure option is available (30 Pa, 60 Pa, 80 Pa/3.1 mmH ₂ O, 6.1 mmH ₂ O, 8.2 mmH ₂ O). Consult your dealer about the specification when setting External static pressure option.	*Above specification data is subject to rounding variation.

1. SPECIFICATIONS

Outdoor units

Model			PURY-P450YSNW-A (-BS)			
Power source			3-phase 4-wire 380-400-415 V 50/60 Hz			
Cooling capacity (Nominal)	*1	kW	50.0			
		kcal/h	45,000			
		BTU/h	170,600			
	Power input	kW	10.59			
	Current input	A	17.8-16.9-16.3			
Temp. range of cooling	EER	kW/kW	4.72			
	Indoor	W.B.	15.0~24.0°C (59~75°F)			
Outdoor	D.B.	-5.0~52.0°C (23~126°F)				
Heating capacity (Max)	*2	kW	56.0			
		kcal/h	50,000			
		BTU/h	191,100			
	Power input	kW	10.99			
	Current input	A	18.5-17.6-16.9			
	COP	kW/kW	5.09			
	(Nominal)	*3	kW	50.0		
			kcal/h	45,000		
			BTU/h	170,600		
		Power input	kW	9.63		
Current input	A	16.2-15.4-14.8				
COP	kW/kW	5.19				
Temp. range of heating	Indoor	D.B.	15.0~27.0°C (59~81°F)			
	Outdoor	W.B.	-20.0~15.5°C (-4~60°F)			
Indoor unit connectable	Total capacity		50~150% of outdoor unit capacity			
	Model/Quantity		P15~P250/1~45			
Sound pressure level (measured in anechoic room) *4		dB <A>	63.0/63.5			
Sound power level (measured in anechoic room) *4		dB <A>	80.5/82.5			
Refrigerant piping diameter	High pressure	mm (in.)	22.2 (7/8) Brazed			
	Low pressure	mm (in.)	28.58 (1-1/8) Brazed			

Set Model						
Model		PURY-P200YNW-A (-BS)		PURY-P250YNW-A (-BS)		
FAN	Type x Quantity	Propeller fan x 1		Propeller fan x 1		
	Air flow rate	m ³ /min	170		185	
		L/s	2,833		3,083	
		cfm	6,003		6,532	
	Control, Driving mechanism	Inverter-control, Direct-driven by motor		Inverter-control, Direct-driven by motor		
Motor output	kW	0.92 x 1		0.92 x 1		
*5 External static press.	0 Pa (0 mmH ₂ O)		0 Pa (0 mmH ₂ O)			
Compressor	Type	Inverter scroll hermetic compressor		Inverter scroll hermetic compressor		
	Manufacture	AC&R Works, MITSUBISHI ELECTRIC CORPORATION		AC&R Works, MITSUBISHI ELECTRIC CORPORATION		
	Starting method	Inverter		Inverter		
	Motor output	kW	5.6		7.0	
	Case heater	kW	-		-	
	Lubricant	MEL32		MEL32		
External finish		Pre-coated galvanized steel sheets (+powder coating for -BS type) <MUNSELL 5Y 8/1 or similar>		Pre-coated galvanized steel sheets (+powder coating for -BS type) <MUNSELL 5Y 8/1 or similar>		
External dimension H x W x D		mm	1,858 (1,798 without legs) x 920 x 740		1,858 (1,798 without legs) x 920 x 740	
		in.	73-3/16 (70-13/16 without legs) x 36-1/4 x 29-3/16		73-3/16 (70-13/16 without legs) x 36-1/4 x 29-3/16	
Protection devices	High pressure protection	High pressure sensor, High pressure switch at 4.15 MPa (601 psi)		High pressure sensor, High pressure switch at 4.15 MPa (601 psi)		
	Inverter circuit (COMP./FAN)	Over-heat protection, Over-current protection		Over-heat protection, Over-current protection		
	Compressor	-		-		
	Fan motor	-		-		
Refrigerant	Type x original charge	R410A x 5.2 kg (12 lbs)		R410A x 5.2 kg (12 lbs)		
	Control	Indoor LEV and BC controller				
Net weight	kg (lbs)	229 (505)		229 (505)		
Heat exchanger	Salt-resistant cross fin & copper tube		Salt-resistant cross fin & copper tube			
HIC circuit (HIC: Heat Inter-Changer)		-				
Pipe between unit and distributor	High pressure	mm (in.)	15.88 (5/8) Brazed		19.05 (3/4) Brazed	
	Low pressure	mm (in.)	19.05 (3/4) Brazed		22.2 (7/8) Brazed	
Defrosting method		Auto-defrost mode (Reversed refrigerant cycle)				
Drawing	External	WKS94T751				
	Wiring	WKE94G339		WKE94G339		
Standard attachment	Document	Installation Manual				
	Accessory	-				
Optional parts		Outdoor Twinning kit: CMY-R100VBK4 Joint: CMY-Y102SS-G2, CMY-Y102LS-G2, CMY-R160-J1 Main BC controller: CMB-P108, 1012, 1016V-JA, CMB-P1016V-KA Sub BC controller: CMB-P104, 108V-KB				
Remarks		Details on foundation work, duct work, insulation work, electrical wiring, power source switch, and other items shall be referred to the Installation Manual. Due to continuing improvement, above specifications may be subject to change without notice.				

Notes:		Unit converter
1. Nominal cooling conditions (subject to JIS B8615-2) Indoor: 27°C D.B./19°C W.B. (81°F D.B./66°F W.B.), Outdoor: 35°C D.B./24°C W.B. (95°F D.B./75°F W.B.) Pipe length: 7.5 m (24-9/16 ft.), Level difference: 0 m (0 ft.)		BTU/h = kW x 3,412
2. Nominal heating conditions (subject to JIS B8615-2) Indoor: 20°C D.B. (68°F D.B.), Outdoor: 7°C D.B./6°C W.B. (45°F D.B./43°F W.B.) Pipe length: 7.5 m (24-9/16 ft.), Level difference: 0 m (0 ft.)		cfm = m ³ /min x 35.31
3. Nominal heating conditions (subject to JIS B8615-2) Indoor: 20°C D.B. (68°F D.B.), Outdoor: 7°C D.B./6°C W.B. (45°F D.B./43°F W.B.) Pipe length: 7.5 m (24-9/16 ft.), Level difference: 0 m (0 ft.) Eurovent registered		lbs = kg/0.4536
4. Cooling mode/Heating mode		
5. External static pressure option is available (30 Pa, 60 Pa, 80 Pa/3.1 mmH ₂ O, 6.1 mmH ₂ O, 8.2 mmH ₂ O). Consult your dealer about the specification when setting External static pressure option.		*Above specification data is subject to rounding variation.

1. SPECIFICATIONS

Outdoor units

Model			PURY-P500YSNW-A (-BS)		
Power source			3-phase 4-wire 380-400-415 V 50/60 Hz		
Cooling capacity (Nominal)	*1	kW	56.0		
		kcal/h	50,000		
		BTU/h	191,100		
	Power input	kW	12.29		
	Current input	A	20.7-19.7-18.9		
EER	kW/kW		4.55		
	Indoor	W.B.	15.0~24.0°C (59~75°F)		
Temp. range of cooling	Outdoor	D.B.	-5.0~52.0°C (23~126°F)		
	Heating capacity (Max)			*2	
(Nominal)	*3	kW	63.0		
		kcal/h	54,200		
		BTU/h	215,000		
	Power input	kW	12.51		
	Current input	A	21.1-20.0-19.3		
COP	kW/kW		5.03		
	Indoor	D.B.	15.0~27.0°C (59~81°F)		
Temp. range of heating	Outdoor	W.B.	-20.0~15.5°C (-4~60°F)		
	Indoor unit connectable			50~150% of outdoor unit capacity	
Model/Quantity			P15-P250/1~50		
Sound pressure level (measured in anechoic room) *4			dB <A>		
Sound power level (measured in anechoic room) *4			dB <A>		
Refrigerant piping diameter	High pressure	mm (in.)	22.2 (7/8) Brazed		
	Low pressure	mm (in.)	28.58 (1-1/8) Brazed		

Set Model			PURY-P250YNW-A (-BS)			PURY-P250YNW-A (-BS)		
Model			PURY-P250YNW-A (-BS)			PURY-P250YNW-A (-BS)		
FAN	Type x Quantity		Propeller fan x 1			Propeller fan x 1		
	Air flow rate	m ³ /min	185			185		
		L/s	3,083			3,083		
		cfm	6,532			6,532		
	Control, Driving mechanism		Inverter-control, Direct-driven by motor			Inverter-control, Direct-driven by motor		
Motor output	kW	0.92 x 1			0.92 x 1			
Compressor	*5 External static press.		0 Pa (0 mmH ₂ O)			0 Pa (0 mmH ₂ O)		
	Type		Inverter scroll hermetic compressor			Inverter scroll hermetic compressor		
	Manufacture		AC&R Works, MITSUBISHI ELECTRIC CORPORATION			AC&R Works, MITSUBISHI ELECTRIC CORPORATION		
	Starting method		Inverter			Inverter		
	Motor output	kW	7.0			7.0		
Case heater	kW	-			-			
Lubricant		MEL32			MEL32			
External finish			Pre-coated galvanized steel sheets (+powder coating for -BS type) <MUNSELL 5Y 8/1 or similar>			Pre-coated galvanized steel sheets (+powder coating for -BS type) <MUNSELL 5Y 8/1 or similar>		
External dimension H x W x D			mm 1,858 (1,798 without legs) x 920 x 740			mm 1,858 (1,798 without legs) x 920 x 740		
			in. 73-3/16 (70-13/16 without legs) x 36-1/4 x 29-3/16			in. 73-3/16 (70-13/16 without legs) x 36-1/4 x 29-3/16		
Protection devices	High pressure protection		High pressure sensor, High pressure switch at 4.15 MPa (601 psi)			High pressure sensor, High pressure switch at 4.15 MPa (601 psi)		
	Inverter circuit (COMP./FAN)		Over-heat protection, Over-current protection			Over-heat protection, Over-current protection		
	Compressor		-			-		
	Fan motor		-			-		
Refrigerant	Type x original charge		R410A x 5.2 kg (12 lbs)			R410A x 5.2 kg (12 lbs)		
	Control		Indoor LEV and BC controller					
Net weight		kg (lbs)	229 (505)			229 (505)		
Heat exchanger			Salt-resistant cross fin & copper tube			Salt-resistant cross fin & copper tube		
HIC circuit (HIC: Heat Inter-Changer)			-			-		
Pipe between unit and distributor	High pressure	mm (in.)	19.05 (3/4) Brazed			19.05 (3/4) Brazed		
	Low pressure	mm (in.)	22.2 (7/8) Brazed			22.2 (7/8) Brazed		
Defrosting method			Auto-defrost mode (Reversed refrigerant cycle)					
Drawing	External		WKS94T751					
	Wiring		WKE94G339			WKE94G339		
Standard attachment	Document		Installation Manual					
	Accessory		-					
Optional parts			Outdoor Twinning kit: CMY-R100VBK4 Joint: CMY-Y102SS-G2, CMY-Y102LS-G2, CMY-R160-J1 Main BC controller: CMB-P108, 1012, 1016V-JA, CMB-P1016V-KA Sub BC controller: CMB-P104, 108V-KB					
Remarks			Details on foundation work, duct work, insulation work, electrical wiring, power source switch, and other items shall be referred to the Installation Manual. Due to continuing improvement, above specifications may be subject to change without notice.					

Notes:		Unit converter	
1. Nominal cooling conditions (subject to JIS B8615-2) Indoor: 27°C D.B./19°C W.B. (81°F D.B./66°F W.B.), Outdoor: 35°C D.B./24°C W.B. (95°F D.B./75°F W.B.) Pipe length: 7.5 m (24-9/16 ft.), Level difference: 0 m (0 ft.)		BTU/h	=kW x 3,412
2. Nominal heating conditions (subject to JIS B8615-2) Indoor: 20°C D.B. (68°F D.B.), Outdoor: 7°C D.B./6°C W.B. (45°F D.B./43°F W.B.) Pipe length: 7.5 m (24-9/16 ft.), Level difference: 0 m (0 ft.)		cfm	=m ³ /min x 35.31
3. Nominal heating conditions (subject to JIS B8615-2) Indoor: 20°C D.B. (68°F D.B.), Outdoor: 7°C D.B./6°C W.B. (45°F D.B./43°F W.B.) Pipe length: 7.5 m (24-9/16 ft.), Level difference: 0 m (0 ft.) Eurovent registered		lbs	=kg/0.4536
4. Cooling mode/Heating mode			
5. External static pressure option is available (30 Pa, 60 Pa, 80 Pa/3.1 mmH ₂ O, 6.1 mmH ₂ O, 8.2 mmH ₂ O). Consult your dealer about the specification when setting External static pressure option.		*Above specification data is subject to rounding variation.	

PURY-P-Y(S)NW-A

1. SPECIFICATIONS

Outdoor units

Model			PURY-P550YSNW-A (-BS)			
Power source			3-phase 4-wire 380-400-415 V 50/60 Hz			
Cooling capacity (Nominal)	*1	kW	63.0			
		kcal/h	54,200			
		BTU/h	215,000			
	Power input	kW	14.45			
	Current input	A	24.3-23.1-22.3			
Temp. range of cooling	EER	kW/kW	4.35			
		Indoor	W.B.	15.0~24.0°C (59~75°F)		
		Outdoor	D.B.	-5.0~52.0°C (23~126°F)		
Heating capacity (Max)	*2	kW	69.0			
		kcal/h	59,300			
		BTU/h	235,400			
	Power input	kW	14.70			
	Current input	A	24.8-23.5-22.7			
	(Nominal)	*3	kW	63.0		
			kcal/h	54,200		
			BTU/h	215,000		
	Power input	kW	13.01			
	Current input	A	21.9-20.8-20.1			
COP	kW/kW	4.84				
Temp. range of heating	Indoor	D.B.	15.0~27.0°C (59~81°F)			
	Outdoor	W.B.	-20.0~15.5°C (-4~60°F)			
Indoor unit connectable	Total capacity		50~150% of outdoor unit capacity			
	Model/Quantity		P15~P250/2~50			
Sound pressure level (measured in anechoic room) *4	dB <A>	64.0/68.0				
Sound power level (measured in anechoic room) *4	dB <A>	82.5/87.5				
Refrigerant piping diameter	High pressure	mm (in.)	22.2 (7/8) Brazed (1-1/8 (28.58) Brazed for the part that exceeds 65 m)			
	Low pressure	mm (in.)	28.58 (1-1/8) Brazed			

Set Model						
Model			PURY-P250YNW-A (-BS)		PURY-P300YNW-A (-BS)	
FAN	Type x Quantity		Propeller fan x 1		Propeller fan x 1	
	Air flow rate	m ³ /min	185		240	
		L/s	3,083		4,000	
		cfm	6,532		8,474	
	Control, Driving mechanism		Inverter-control, Direct-driven by motor		Inverter-control, Direct-driven by motor	
	Motor output	kW	0.92 x 1		0.92 x 1	
*5	External static press.		0 Pa (0 mmH ₂ O)		0 Pa (0 mmH ₂ O)	
Compressor	Type		Inverter scroll hermetic compressor		Inverter scroll hermetic compressor	
	Manufacture		AC&R Works, MITSUBISHI ELECTRIC CORPORATION		AC&R Works, MITSUBISHI ELECTRIC CORPORATION	
	Starting method		Inverter		Inverter	
	Motor output	kW	7.0		7.9	
	Case heater	kW	-		-	
Lubricant		MEL32		MEL32		
External finish			Pre-coated galvanized steel sheets (+powder coating for -BS type) <MUNSELL 5Y 8/1 or similar>		Pre-coated galvanized steel sheets (+powder coating for -BS type) <MUNSELL 5Y 8/1 or similar>	
External dimension H x W x D			mm		mm	
			1,858 (1,798 without legs) x 920 x 740		1,858 (1,798 without legs) x 920 x 740	
			in.		in.	
			73-3/16 (70-13/16 without legs) x 36-1/4 x 29-3/16		73-3/16 (70-13/16 without legs) x 36-1/4 x 29-3/16	
Protection devices	High pressure protection		High pressure sensor, High pressure switch at 4.15 MPa (601 psi)		High pressure sensor, High pressure switch at 4.15 MPa (601 psi)	
	Inverter circuit (COMP./FAN)		Over-heat protection, Over-current protection		Over-heat protection, Over-current protection	
	Compressor		-		-	
	Fan motor		-		-	
Refrigerant	Type x original charge		R410A x 5.2 kg (12 lbs)		R410A x 5.2 kg (12 lbs)	
	Control		Indoor LEV and BC controller			
Net weight	kg (lbs)	229 (505)		231 (510)		
Heat exchanger			Salt-resistant cross fin & copper tube		Salt-resistant cross fin & copper tube	
HIC circuit (HIC: Heat Inter-Changer)			-		-	
Pipe between unit and distributor	High pressure	mm (in.)	19.05 (3/4) Brazed		19.05 (3/4) Brazed	
	Low pressure	mm (in.)	22.2 (7/8) Brazed		22.2 (7/8) Brazed	
Defrosting method			Auto-defrost mode (Reversed refrigerant cycle)			
Drawing	External		WKS94T751			
	Wiring		WKE94G339		WKE94G339	
Standard attachment	Document		Installation Manual			
	Accessory		-			
Optional parts			Outdoor Twinning kit: CMY-R100VBK4 Joint: CMY-Y102SS-G2, CMY-Y102LS-G2, CMY-R160-J1 Main BC controller: CMB-P108, 1012, 1016V-JA, CMB-P1016V-KA Sub BC controller: CMB-P104, 108V-KB			
Remarks			Details on foundation work, duct work, insulation work, electrical wiring, power source switch, and other items shall be referred to the Installation Manual. Due to continuing improvement, above specifications may be subject to change without notice. When the high pressure piping length is 65 m or less, use 7/8 (22.2) pipe. When the high pressure piping length exceeds 65 m, use 7/8 (22.2) pipe until 65 m, use 1-1/8 (28.58) pipe for the part that exceeds 65 m.			

Notes:		Unit converter	
1. Nominal cooling conditions (subject to JIS B8615-2) Indoor: 27°C D.B./19°C W.B. (81°F D.B./66°F W.B.), Outdoor: 35°C D.B./24°C W.B. (95°F D.B./75°F W.B.) Pipe length: 7.5 m (24-9/16 ft.), Level difference: 0 m (0 ft.) 2. Nominal heating conditions (subject to JIS B8615-2) Indoor: 20°C D.B. (68°F D.B.), Outdoor: 7°C D.B./6°C W.B. (45°F D.B./43°F W.B.) Pipe length: 7.5 m (24-9/16 ft.), Level difference: 0 m (0 ft.) 3. Nominal heating conditions (subject to JIS B8615-2) Indoor: 20°C D.B. (68°F D.B.), Outdoor: 7°C D.B./6°C W.B. (45°F D.B./43°F W.B.) Pipe length: 7.5 m (24-9/16 ft.), Level difference: 0 m (0 ft.) Eurovent registered 4. Cooling mode/Heating mode 5. External static pressure option is available (30 Pa, 60 Pa, 80 Pa/3.1 mmH ₂ O, 6.1 mmH ₂ O, 8.2 mmH ₂ O). Consult your dealer about the specification when setting External static pressure option.		BTU/h =kW x 3.412 cfm =m ³ /min x 35.31 lbs =kg/0.4536 *Above specification data is subject to rounding variation.	

1. SPECIFICATIONS

Outdoor units

Model			PURY-P600YSNW-A (-BS)			
Power source			3-phase 4-wire 380-400-415 V 50/60 Hz			
Cooling capacity (Nominal)	*1	kW	69.0			
		kcal/h	59,300			
		BTU/h	235,400			
	Power input	kW	16.62			
	Current input	A	28.0-26.6-25.6			
Temp. range of cooling	EER	kW/kW	4.15			
		Indoor	W.B.	15.0~24.0°C (59~75°F)		
		Outdoor	D.B.	-5.0~52.0°C (23~126°F)		
Heating capacity (Max)	*2	kW	76.5			
		kcal/h	65,800			
		BTU/h	261,000			
	Power input	kW	17.62			
	Current input	A	29.7-28.2-27.2			
	(Nominal)	*3	kW	69.0		
			kcal/h	59,300		
			BTU/h	235,400		
	Power input	kW	15.26			
	Current input	A	25.7-24.4-23.5			
COP	kW/kW	4.52				
Temp. range of heating	Indoor	D.B.	15.0~27.0°C (59~81°F)			
	Outdoor	W.B.	-20.0~15.5°C (-4~60°F)			
Indoor unit connectable	Total capacity	50~150% of outdoor unit capacity				
	Model/Quantity	P15~P250/2~50				
Sound pressure level (measured in anechoic room) *4	dB <A>		64.0/70.0			
Sound power level (measured in anechoic room) *4	dB <A>		83.0/89.5			
Refrigerant piping diameter	High pressure	mm (in.)	22.2 (7/8) Brazed (1-1/8 (28.58) Brazed for the part that exceeds 65 m)			
	Low pressure	mm (in.)	28.58 (1-1/8) Brazed			

Set Model			PURY-P300YNW-A (-BS)			PURY-P300YNW-A (-BS)		
FAN	Type x Quantity		Propeller fan x 1			Propeller fan x 1		
	Air flow rate	m ³ /min	240			240		
		L/s	4,000			4,000		
		cfm	8,474			8,474		
	Control, Driving mechanism		Inverter-control, Direct-driven by motor			Inverter-control, Direct-driven by motor		
	Motor output	kW	0.92 x 1			0.92 x 1		
*5 External static press.		0 Pa (0 mmH ₂ O)			0 Pa (0 mmH ₂ O)			
Compressor	Type		Inverter scroll hermetic compressor			Inverter scroll hermetic compressor		
	Manufacture		AC&R Works, MITSUBISHI ELECTRIC CORPORATION			AC&R Works, MITSUBISHI ELECTRIC CORPORATION		
	Starting method		Inverter			Inverter		
	Motor output	kW	7.9			7.9		
	Case heater	kW	-			-		
Lubricant		MEL32			MEL32			
External finish			Pre-coated galvanized steel sheets (+powder coating for -BS type) <MUNSELL 5Y 8/1 or similar>			Pre-coated galvanized steel sheets (+powder coating for -BS type) <MUNSELL 5Y 8/1 or similar>		
External dimension H x W x D		mm	1,858 (1,798 without legs) x 920 x 740			1,858 (1,798 without legs) x 920 x 740		
		in.	73-3/16 (70-13/16 without legs) x 36-1/4 x 29-3/16			73-3/16 (70-13/16 without legs) x 36-1/4 x 29-3/16		
Protection devices	High pressure protection		High pressure sensor, High pressure switch at 4.15 MPa (601 psi)			High pressure sensor, High pressure switch at 4.15 MPa (601 psi)		
	Inverter circuit (COMP./FAN)		Over-heat protection, Over-current protection			Over-heat protection, Over-current protection		
	Compressor		-			-		
	Fan motor		-			-		
Refrigerant	Type x original charge		R410A x 5.2 kg (12 lbs)			R410A x 5.2 kg (12 lbs)		
	Control		Indoor LEV and BC controller					
Net weight	kg (lbs)		231 (510)			231 (510)		
Heat exchanger			Salt-resistant cross fin & copper tube			Salt-resistant cross fin & copper tube		
HIC circuit (HIC: Heat Inter-Changer)			-			-		
Pipe between unit and distributor	High pressure	mm (in.)	19.05 (3/4) Brazed			19.05 (3/4) Brazed		
	Low pressure	mm (in.)	22.2 (7/8) Brazed			22.2 (7/8) Brazed		
Defrosting method			Auto-defrost mode (Reversed refrigerant cycle)					
Drawing	External		WKS94T751					
	Wiring		WKE94G339			WKE94G339		
Standard attachment	Document		Installation Manual					
	Accessory		-					
Optional parts			Outdoor Twinning kit: CMY-R100VBK4 Joint: CMY-Y102SS-G2, CMY-Y102LS-G2, CMY-R160-J1 Main BC controller: CMB-P108, 1012, 1016V-JA, CMB-P1016V-KA Sub BC controller: CMB-P104, 108V-KB					
Remarks			Details on foundation work, duct work, insulation work, electrical wiring, power source switch, and other items shall be referred to the Installation Manual. Due to continuing improvement, above specifications may be subject to change without notice. When the high pressure piping length is 65 m or less, use 7/8 (22.2) pipe. When the high pressure piping length exceeds 65 m, use 7/8 (22.2) pipe until 65 m, use 1-1/8 (28.58) pipe for the part that exceeds 65 m.					

Notes:		Unit converter	
1. Nominal cooling conditions (subject to JIS B8615-2) Indoor: 27°C D.B./19°C W.B. (81°F D.B./66°F W.B.), Outdoor: 35°C D.B./24°C W.B. (95°F D.B./75°F W.B.) Pipe length: 7.5 m (24-9/16 ft.), Level difference: 0 m (0 ft.)		BTU/h	=kW x 3,412
2. Nominal heating conditions (subject to JIS B8615-2) Indoor: 20°C D.B. (68°F D.B.), Outdoor: 7°C D.B./6°C W.B. (45°F D.B./43°F W.B.) Pipe length: 7.5 m (24-9/16 ft.), Level difference: 0 m (0 ft.)		cfm	=m ³ /min x 35.31
3. Nominal heating conditions (subject to JIS B8615-2) Indoor: 20°C D.B. (68°F D.B.), Outdoor: 7°C D.B./6°C W.B. (45°F D.B./43°F W.B.) Pipe length: 7.5 m (24-9/16 ft.), Level difference: 0 m (0 ft.) Eurovent registered		lbs	=kg/0.4536
4. Cooling mode/Heating mode			
5. External static pressure option is available (30 Pa, 60 Pa, 80 Pa/3.1 mmH ₂ O, 6.1 mmH ₂ O, 8.2 mmH ₂ O). Consult your dealer about the specification when setting External static pressure option.		*Above specification data is subject to rounding variation.	

1. SPECIFICATIONS

Outdoor units

Model			PURY-P650YSNW-A (-BS)			
Power source			3-phase 4-wire 380-400-415 V 50/60 Hz			
Cooling capacity (Nominal)	*1	kW	73.0			
		kcal/h	62,800			
		BTU/h	249,100			
	Power input	kW	18.19			
	Current input	A	30.7-29.1-28.1			
Temp. range of cooling	Indoor	W.B.	15.0~24.0°C (59~75°F)			
	Outdoor	D.B.	-5.0~52.0°C (23~126°F)			
Heating capacity (Max)	*2	kW	81.5			
		kcal/h	70,100			
		BTU/h	278,100			
	Power input	kW	19.35			
	Current input	A	32.6-31.0-29.9			
	COP	kW/kW	4.21			
	(Nominal)	*3	kW	73.0		
			kcal/h	62,800		
			BTU/h	249,100		
		Power input	kW	16.39		
Current input	A	27.6-26.2-25.3				
COP	kW/kW	4.45				
Temp. range of heating	Indoor	D.B.	15.0~27.0°C (59~81°F)			
	Outdoor	W.B.	-20.0~15.5°C (-4~60°F)			
Indoor unit connectable	Total capacity		50~150% of outdoor unit capacity			
	Model/Quantity		P15~P250/2~50			
Sound pressure level (measured in anechoic room) *4		dB <A>	65.0/69.0			
Sound power level (measured in anechoic room) *4		dB <A>	83.5/88.5			
Refrigerant piping diameter	High pressure	mm (in.)	28.58 (1-1/8) Brazed			
	Low pressure	mm (in.)	28.58 (1-1/8) Brazed			

Set Model						
Model		PURY-P300YNW-A (-BS)		PURY-P350YNW-A (-BS)		
FAN	Type x Quantity		Propeller fan x 1		Propeller fan x 2	
	Air flow rate	m ³ /min	240		250	
		L/s	4,000		4,167	
		cfm	8,474		8,828	
	Control, Driving mechanism		Inverter-control, Direct-driven by motor		Inverter-control, Direct-driven by motor	
Motor output	kW	0.92 x 1		0.46 x 2		
*5	External static press.		0 Pa (0 mmH ₂ O)		0 Pa (0 mmH ₂ O)	
Compressor	Type		Inverter scroll hermetic compressor		Inverter scroll hermetic compressor	
	Manufacture		AC&R Works, MITSUBISHI ELECTRIC CORPORATION		AC&R Works, MITSUBISHI ELECTRIC CORPORATION	
	Starting method		Inverter		Inverter	
	Motor output	kW	7.9		10.2	
	Case heater	kW	-		-	
Lubricant		MEL32		MEL32		
External finish		Pre-coated galvanized steel sheets (+powder coating for -BS type) <MUNSELL 5Y 8/1 or similar>		Pre-coated galvanized steel sheets (+powder coating for -BS type) <MUNSELL 5Y 8/1 or similar>		
External dimension H x W x D		mm	1,858 (1,798 without legs) x 920 x 740		1,858 (1,798 without legs) x 1,240 x 740	
		in.	73-3/16 (70-13/16 without legs) x 36-1/4 x 29-3/16		73-3/16 (70-13/16 without legs) x 48-7/8 x 29-3/16	
Protection devices	High pressure protection		High pressure sensor, High pressure switch at 4.15 MPa (601 psi)		High pressure sensor, High pressure switch at 4.15 MPa (601 psi)	
	Inverter circuit (COMP./FAN)		Over-heat protection, Over-current protection		Over-heat protection, Over-current protection	
	Compressor		-		-	
	Fan motor		-		-	
Refrigerant	Type x original charge		R410A x 5.2 kg (12 lbs)		R410A x 8.0 kg (18 lbs)	
	Control		Indoor LEV and BC controller			
Net weight	kg (lbs)	231 (510)		273 (602)		
Heat exchanger		Salt-resistant cross fin & copper tube		Salt-resistant cross fin & copper tube		
HIC circuit (HIC: Heat Inter-Changer)		-		-		
Pipe between unit and distributor	High pressure	mm (in.)	19.05 (3/4) Brazed		19.05 (3/4) Brazed	
	Low pressure	mm (in.)	22.2 (7/8) Brazed		28.58 (1-1/8) Brazed	
Defrosting method		Auto-defrost mode (Reversed refrigerant cycle)				
Drawing	External		WKS94T752			
	Wiring		WKE94G339		WKE94G341	
Standard attachment	Document		Installation Manual			
	Accessory		-			
Optional parts		Outdoor Twinning kit: CMY-R100VBK4 Joint: CMY-Y102SS-G2, CMY-Y102LS-G2, CMY-R160-J1 Main BC controller: CMB-P108, 1012, 1016V-JA, CMB-P1016V-KA Sub BC controller: CMB-P104, 108V-KB				
Remarks		Details on foundation work, duct work, insulation work, electrical wiring, power source switch, and other items shall be referred to the Installation Manual. Due to continuing improvement, above specifications may be subject to change without notice.				

Notes:		Unit converter
1. Nominal cooling conditions (subject to JIS B8615-2) Indoor: 27°C D.B./19°C W.B. (81°F D.B./66°F W.B.), Outdoor: 35°C D.B./24°C W.B. (95°F D.B./75°F W.B.) Pipe length: 7.5 m (24-9/16 ft.), Level difference: 0 m (0 ft.)		BTU/h = kW x 3,412
2. Nominal heating conditions (subject to JIS B8615-2) Indoor: 20°C D.B. (68°F D.B.), Outdoor: 7°C D.B./6°C W.B. (45°F D.B./43°F W.B.) Pipe length: 7.5 m (24-9/16 ft.), Level difference: 0 m (0 ft.)		cfm = m ³ /min x 35.31
3. Nominal heating conditions (subject to JIS B8615-2) Indoor: 20°C D.B. (68°F D.B.), Outdoor: 7°C D.B./6°C W.B. (45°F D.B./43°F W.B.) Pipe length: 7.5 m (24-9/16 ft.), Level difference: 0 m (0 ft.) Eurovent registered		lbs = kg/0.4536
4. Cooling mode/Heating mode		
5. External static pressure option is available (30 Pa, 60 Pa, 80 Pa/3.1 mmH ₂ O, 6.1 mmH ₂ O, 8.2 mmH ₂ O). Consult your dealer about the specification when setting External static pressure option.		*Above specification data is subject to rounding variation.

1. SPECIFICATIONS

Outdoor units

Model			PURY-P700YSNW-A (-BS)	
Power source			3-phase 4-wire 380-400-415 V 50/60 Hz	
Cooling capacity (Nominal)	*1	kW	80.0	
		kcal/h	68,800	
		BTU/h	273,000	
	Power input	kW	20.72	
	Current input	A	34.9-33.2-32.0	
Temp. range of cooling	Indoor	W.B.	15.0~24.0°C (59~75°F)	
	Outdoor	D.B.	-5.0~52.0°C (23~126°F)	
Heating capacity (Max)	*2	kW	88.0	
		kcal/h	75,700	
		BTU/h	300,300	
	Power input	kW	21.56	
	Current input	A	36.3-34.5-33.3	
	COP	kW/kW	4.08	
	(Nominal)	*3	kW	80.0
kcal/h			68,800	
BTU/h			273,000	
Power input		kW	18.25	
Temp. range of heating	Indoor	D.B.	15.0~27.0°C (59~81°F)	
	Outdoor	W.B.	-20.0~15.5°C (-4~60°F)	
Indoor unit connectable	Total capacity	50~150% of outdoor unit capacity		
	Model/Quantity	P15~P250/2~50		
Sound pressure level (measured in anechoic room) *4	dB <A>		65.5/67.0	
Sound power level (measured in anechoic room) *4	dB <A>		84.0/86.0	
Refrigerant	High pressure	mm (in.)	28.58 (1-1/8) Brazed	
piping diameter	Low pressure	mm (in.)	34.93 (1-3/8) Brazed	

Set Model			PURY-P350YNW-A (-BS)		PURY-P350YNW-A (-BS)	
FAN	Type x Quantity		Propeller fan x 2		Propeller fan x 2	
	Air flow rate	m ³ /min	250		250	
		L/s	4,167		4,167	
		cfm	8,828		8,828	
	Control, Driving mechanism		Inverter-control, Direct-driven by motor		Inverter-control, Direct-driven by motor	
	Motor output	kW	0.46 x 2		0.46 x 2	
*5 External static press.			0 Pa (0 mmH ₂ O)		0 Pa (0 mmH ₂ O)	
Compressor	Type		Inverter scroll hermetic compressor		Inverter scroll hermetic compressor	
	Manufacture		AC&R Works, MITSUBISHI ELECTRIC CORPORATION		AC&R Works, MITSUBISHI ELECTRIC CORPORATION	
	Starting method		Inverter		Inverter	
	Motor output	kW	10.2		10.2	
	Case heater	kW	-		-	
Lubricant		MEL32		MEL32		
External finish			Pre-coated galvanized steel sheets (+powder coating for -BS type) <MUNSELL 5Y 8/1 or similar>		Pre-coated galvanized steel sheets (+powder coating for -BS type) <MUNSELL 5Y 8/1 or similar>	
External dimension H x W x D			mm 1,858 (1,798 without legs) x 1,240 x 740 73-3/16 (70-13/16 without legs) x 48-7/8 x 29-3/16		mm 1,858 (1,798 without legs) x 1,240 x 740 73-3/16 (70-13/16 without legs) x 48-7/8 x 29-3/16	
Protection devices	High pressure protection		High pressure sensor, High pressure switch at 4.15 MPa (601 psi)		High pressure sensor, High pressure switch at 4.15 MPa (601 psi)	
	Inverter circuit (COMP./FAN)		Over-heat protection, Over-current protection		Over-heat protection, Over-current protection	
	Compressor		-		-	
	Fan motor		-		-	
Refrigerant	Type x original charge		R410A x 8.0 kg (18 lbs)		R410A x 8.0 kg (18 lbs)	
	Control		Indoor LEV and BC controller			
Net weight			kg (lbs) 273 (602)		kg (lbs) 273 (602)	
Heat exchanger			Salt-resistant cross fin & copper tube			
HIC circuit (HIC: Heat Inter-Changer)			-			
Pipe between unit and distributor	High pressure	mm (in.)	19.05 (3/4) Brazed		19.05 (3/4) Brazed	
	Low pressure	mm (in.)	28.58 (1-1/8) Brazed		28.58 (1-1/8) Brazed	
Defrosting method			Auto-defrost mode (Reversed refrigerant cycle)			
Drawing	External		WKS94T753			
	Wiring		WKE94G341		WKE94G341	
Standard attachment	Document		Installation Manual			
	Accessory		-			
Optional parts			Outdoor Twinning kit: CMY-R200VBK4 Joint: CMY-Y102SS-G2, CMY-Y102LS-G2, CMY-R160-J1 Main BC controller: CMB-P108, 1012, 1016V-JA, CMB-P1016V-KA Sub BC controller: CMB-P104, 108V-KB			
Remarks			Details on foundation work, duct work, insulation work, electrical wiring, power source switch, and other items shall be referred to the Installation Manual. Due to continuing improvement, above specifications may be subject to change without notice.			

Notes:	Unit converter
1. Nominal cooling conditions (subject to JIS B8615-2) Indoor: 27°C D.B./19°C W.B. (81°F D.B./66°F W.B.), Outdoor: 35°C D.B./24°C W.B. (95°F D.B./75°F W.B.) Pipe length: 7.5 m (24-9/16 ft.), Level difference: 0 m (0 ft.)	BTU/h = kW x 3,412
2. Nominal heating conditions (subject to JIS B8615-2) Indoor: 20°C D.B. (68°F D.B.), Outdoor: 7°C D.B./6°C W.B. (45°F D.B./43°F W.B.) Pipe length: 7.5 m (24-9/16 ft.), Level difference: 0 m (0 ft.)	cfm = m ³ /min x 35.31
3. Nominal heating conditions (subject to JIS B8615-2) Indoor: 20°C D.B. (68°F D.B.), Outdoor: 7°C D.B./6°C W.B. (45°F D.B./43°F W.B.) Pipe length: 7.5 m (24-9/16 ft.), Level difference: 0 m (0 ft.) Eurovent registered	lbs = kg/0.4536
4. Cooling mode/Heating mode	
5. External static pressure option is available (30 Pa, 60 Pa, 80 Pa/3.1 mmH ₂ O, 6.1 mmH ₂ O, 8.2 mmH ₂ O). Consult your dealer about the specification when setting External static pressure option.	*Above specification data is subject to rounding variation.

1. SPECIFICATIONS

Outdoor units

Model			PURY-P750YSNW-A (-BS)			
Power source			3-phase 4-wire 380-400-415 V 50/60 Hz			
Cooling capacity (Nominal)	*1	kW	85.0			
		kcal/h	73,100			
		BTU/h	290,000			
	Power input	kW	22.30			
	Current input	A	37.6-35.7-34.4			
Temp. range of cooling	Indoor	W.B.	15.0~24.0°C (59~75°F)			
	Outdoor	D.B.	-5.0~52.0°C (23~126°F)			
Heating capacity (Max)	*2	kW	95.0			
		kcal/h	81,700			
		BTU/h	324,100			
	Power input	kW	24.86			
	Current input	A	41.9-39.8-38.4			
	COP	kW/kW	3.82			
	(Nominal)	*3	kW	85.0		
			kcal/h	73,100		
			BTU/h	290,000		
		Power input	kW	19.71		
Current input	A	33.2-31.6-30.4				
COP	kW/kW	4.31				
Temp. range of heating	Indoor	D.B.	15.0~27.0°C (59~81°F)			
	Outdoor	W.B.	-20.0~15.5°C (-4~60°F)			
Indoor unit connectable	Total capacity		50~150% of outdoor unit capacity			
	Model/Quantity		P15~P250/2~50			
Sound pressure level (measured in anechoic room) *4		dB <A>	67.0/70.5			
Sound power level (measured in anechoic room) *4		dB <A>	85.5/89.5			
Refrigerant piping diameter	High pressure	mm (in.)	28.58 (1-1/8) Brazed			
	Low pressure	mm (in.)	34.93 (1-3/8) Brazed			

Set Model						
Model		PURY-P350YNW-A (-BS)		PURY-P400YNW-A (-BS)		
FAN	Type x Quantity		Propeller fan x 2		Propeller fan x 2	
	Air flow rate	m ³ /min	250		315	
		L/s	4,167		5,250	
		cfm	8,828		11,123	
	Control, Driving mechanism		Inverter-control, Direct-driven by motor		Inverter-control, Direct-driven by motor	
Motor output	kW	0.46 x 2		0.46 x 2		
Compressor	*5 External static press.		0 Pa (0 mmH ₂ O)		0 Pa (0 mmH ₂ O)	
	Type		Inverter scroll hermetic compressor		Inverter scroll hermetic compressor	
	Manufacture		AC&R Works, MITSUBISHI ELECTRIC CORPORATION		AC&R Works, MITSUBISHI ELECTRIC CORPORATION	
	Starting method		Inverter		Inverter	
	Motor output	kW	10.2		10.9	
	Case heater	kW	-		-	
Lubricant		MEL32		MEL32		
External finish		Pre-coated galvanized steel sheets (+powder coating for -BS type) <MUNSELL 5Y 8/1 or similar>		Pre-coated galvanized steel sheets (+powder coating for -BS type) <MUNSELL 5Y 8/1 or similar>		
External dimension H x W x D		mm	1,858 (1,798 without legs) x 1,240 x 740		1,858 (1,798 without legs) x 1,240 x 740	
		in.	73-3/16 (70-13/16 without legs) x 48-7/8 x 29-3/16		73-3/16 (70-13/16 without legs) x 48-7/8 x 29-3/16	
Protection devices	High pressure protection		High pressure sensor, High pressure switch at 4.15 MPa (601 psi)		High pressure sensor, High pressure switch at 4.15 MPa (601 psi)	
	Inverter circuit (COMP./FAN)		Over-heat protection, Over-current protection		Over-heat protection, Over-current protection	
	Compressor		-		-	
	Fan motor		-		-	
Refrigerant	Type x original charge		R410A x 8.0 kg (18 lbs)		R410A x 8.0 kg (18 lbs)	
	Control		Indoor LEV and BC controller			
Net weight	kg (lbs)	273 (602)		273 (602)		
Heat exchanger		Salt-resistant cross fin & copper tube		Salt-resistant cross fin & copper tube		
HIC circuit (HIC: Heat Inter-Changer)		-		-		
Pipe between unit and distributor	High pressure	mm (in.)	19.05 (3/4) Brazed		22.2 (7/8) Brazed	
	Low pressure	mm (in.)	28.58 (1-1/8) Brazed		28.58 (1-1/8) Brazed	
Defrosting method		Auto-defrost mode (Reversed refrigerant cycle)				
Drawing	External		WKS94T753			
	Wiring		WKE94G341		WKE94G341	
Standard attachment	Document		Installation Manual			
	Accessory		-			
Optional parts		Outdoor Twinning kit: CMY-R200VBK4 Joint: CMY-Y102SS-G2, CMY-Y102LS-G2, CMY-R160-J1 Main BC controller: CMB-P108, 1012, 1016V-JA, CMB-P1016V-KA Sub BC controller: CMB-P104, 108V-KB				
Remarks		Details on foundation work, duct work, insulation work, electrical wiring, power source switch, and other items shall be referred to the Installation Manual. Due to continuing improvement, above specifications may be subject to change without notice.				

Notes:		Unit converter
1. Nominal cooling conditions (subject to JIS B8615-2) Indoor: 27°C D.B./19°C W.B. (81°F D.B./66°F W.B.), Outdoor: 35°C D.B./24°C W.B. (95°F D.B./75°F W.B.) Pipe length: 7.5 m (24-9/16 ft.), Level difference: 0 m (0 ft.)		BTU/h = kW x 3,412
2. Nominal heating conditions (subject to JIS B8615-2) Indoor: 20°C D.B. (68°F D.B.), Outdoor: 7°C D.B./6°C W.B. (45°F D.B./43°F W.B.) Pipe length: 7.5 m (24-9/16 ft.), Level difference: 0 m (0 ft.)		cfm = m ³ /min x 35.31
3. Nominal heating conditions (subject to JIS B8615-2) Indoor: 20°C D.B. (68°F D.B.), Outdoor: 7°C D.B./6°C W.B. (45°F D.B./43°F W.B.) Pipe length: 7.5 m (24-9/16 ft.), Level difference: 0 m (0 ft.) Eurovent registered		lbs = kg/0.4536
4. Cooling mode/Heating mode		
5. External static pressure option is available (30 Pa, 60 Pa, 80 Pa/3.1 mmH ₂ O, 6.1 mmH ₂ O, 8.2 mmH ₂ O). Consult your dealer about the specification when setting External static pressure option.		*Above specification data is subject to rounding variation.

1. SPECIFICATIONS

Outdoor units

Model			PURY-P800YSNW-A (-BS)			
Power source			3-phase 4-wire 380-400-415 V 50/60 Hz			
Cooling capacity (Nominal)	*1	kW	90.0			
		kcal/h	77,400			
		BTU/h	307,100			
	Power input	kW	23.93			
	Current input	A	40.3-38.3-36.9			
		EER	kW/kW			
Temp. range of cooling	Indoor	W.B.	15.0~24.0°C (59~75°F)			
	Outdoor	D.B.	-5.0~52.0°C (23~126°F)			
Heating capacity (Max)	*2	kW	100.0			
		kcal/h	86,000			
		BTU/h	341,200			
	Power input	kW	28.16			
	Current input	A	47.5-45.1-43.5			
	COP	kW/kW	3.55			
	(Nominal)	*3	kW	90.0		
			kcal/h	77,400		
			BTU/h	307,100		
		Power input	kW	21.22		
Current input	A	35.8-34.0-32.8				
COP	kW/kW	4.24				
Temp. range of heating	Indoor	D.B.	15.0~27.0°C (59~81°F)			
	Outdoor	W.B.	-20.0~15.5°C (-4~60°F)			
Indoor unit connectable	Total capacity		50~150% of outdoor unit capacity			
	Model/Quantity		P15~P250/2~50			
Sound pressure level (measured in anechoic room) *4		dB <A>	68.0/72.0			
Sound power level (measured in anechoic room) *4		dB <A>	86.0/91.0			
Refrigerant piping diameter	High pressure	mm (in.)	28.58 (1-1/8) Brazed			
	Low pressure	mm (in.)	34.93 (1-3/8) Brazed			

Set Model			PURY-P400YNW-A (-BS)			PURY-P400YNW-A (-BS)		
Model			PURY-P400YNW-A (-BS)			PURY-P400YNW-A (-BS)		
FAN	Type x Quantity		Propeller fan x 2			Propeller fan x 2		
	Air flow rate	m ³ /min	315			315		
		L/s	5,250			5,250		
		cfm	11,123			11,123		
	Control, Driving mechanism		Inverter-control, Direct-driven by motor			Inverter-control, Direct-driven by motor		
	Motor output	kW	0.46 x 2			0.46 x 2		
*5	External static press.		0 Pa (0 mmH ₂ O)			0 Pa (0 mmH ₂ O)		
Compressor	Type		Inverter scroll hermetic compressor			Inverter scroll hermetic compressor		
	Manufacture		AC&R Works, MITSUBISHI ELECTRIC CORPORATION			AC&R Works, MITSUBISHI ELECTRIC CORPORATION		
	Starting method		Inverter			Inverter		
	Motor output	kW	10.9			10.9		
	Case heater	kW	-			-		
	Lubricant		MEL32			MEL32		
External finish			Pre-coated galvanized steel sheets (+powder coating for -BS type) <MUNSELL 5Y 8/1 or similar>			Pre-coated galvanized steel sheets (+powder coating for -BS type) <MUNSELL 5Y 8/1 or similar>		
External dimension H x W x D			mm 1,858 (1,798 without legs) x 1,240 x 740			mm 1,858 (1,798 without legs) x 1,240 x 740		
			in. 73-3/16 (70-13/16 without legs) x 48-7/8 x 29-3/16			in. 73-3/16 (70-13/16 without legs) x 48-7/8 x 29-3/16		
Protection devices	High pressure protection		High pressure sensor, High pressure switch at 4.15 MPa (601 psi)			High pressure sensor, High pressure switch at 4.15 MPa (601 psi)		
	Inverter circuit (COMP./FAN)		Over-heat protection, Over-current protection			Over-heat protection, Over-current protection		
	Compressor		-			-		
	Fan motor		-			-		
Refrigerant	Type x original charge		R410A x 8.0 kg (18 lbs)			R410A x 8.0 kg (18 lbs)		
	Control		Indoor LEV and BC controller					
Net weight		kg (lbs)	273 (602)			273 (602)		
Heat exchanger			Salt-resistant cross fin & copper tube			Salt-resistant cross fin & copper tube		
HIC circuit (HIC: Heat Inter-Changer)			-			-		
Pipe between unit and distributor	High pressure	mm (in.)	22.2 (7/8) Brazed			22.2 (7/8) Brazed		
	Low pressure	mm (in.)	28.58 (1-1/8) Brazed			28.58 (1-1/8) Brazed		
Defrosting method			Auto-defrost mode (Reversed refrigerant cycle)					
Drawing	External		WKS94T753					
	Wiring		WKE94G341			WKE94G341		
Standard attachment	Document		Installation Manual					
	Accessory		-					
Optional parts			Outdoor Twinning kit: CMY-R200VBK4 Joint: CMY-Y102SS-G2, CMY-Y102LS-G2, CMY-R160-J1 Main BC controller: CMB-P108, 1012, 1016V-JA, CMB-P1016V-KA Sub BC controller: CMB-P104, 108V-KB					
Remarks			Details on foundation work, duct work, insulation work, electrical wiring, power source switch, and other items shall be referred to the Installation Manual. Due to continuing improvement, above specifications may be subject to change without notice.					

Notes:		Unit converter	
1. Nominal cooling conditions (subject to JIS B8615-2) Indoor: 27°C D.B./19°C W.B. (81°F D.B./66°F W.B.), Outdoor: 35°C D.B./24°C W.B. (95°F D.B./75°F W.B.) Pipe length: 7.5 m (24-9/16 ft.), Level difference: 0 m (0 ft.)		BTU/h	=kW x 3,412
2. Nominal heating conditions (subject to JIS B8615-2) Indoor: 20°C D.B. (68°F D.B.), Outdoor: 7°C D.B./6°C W.B. (45°F D.B./43°F W.B.) Pipe length: 7.5 m (24-9/16 ft.), Level difference: 0 m (0 ft.)		cfm	=m ³ /min x 35.31
3. Nominal heating conditions (subject to JIS B8615-2) Indoor: 20°C D.B. (68°F D.B.), Outdoor: 7°C D.B./6°C W.B. (45°F D.B./43°F W.B.) Pipe length: 7.5 m (24-9/16 ft.), Level difference: 0 m (0 ft.) Eurovent registered		lbs	=kg/0.4536
4. Cooling mode/Heating mode			
5. External static pressure option is available (30 Pa, 60 Pa, 80 Pa/3.1 mmH ₂ O, 6.1 mmH ₂ O, 8.2 mmH ₂ O). Consult your dealer about the specification when setting External static pressure option.		*Above specification data is subject to rounding variation.	

PURY-P-Y(S)NW-A

1. SPECIFICATIONS

Outdoor units

Model			PURY-P850YSNW-A (-BS)			
Power source			3-phase 4-wire 380-400-415 V 50/60 Hz			
Cooling capacity (Nominal)	*1	kW	96.0			
		kcal/h	82,600			
		BTU/h	327,600			
	Power input	kW	24.99			
	Current input	A	42.1-40.0-38.6			
Temp. range of cooling	EER	kW/kW	3.84			
	Indoor	W.B.	15.0~24.0°C (59~75°F)			
Outdoor	D.B.	-5.0~52.0°C (23~126°F)				
Heating capacity (Max)	*2	kW	108.0			
		kcal/h	92,900			
		BTU/h	368,500			
	Power input	kW	28.49			
	Current input	A	48.0-45.6-44.0			
	COP	kW/kW	3.79			
	(Nominal)	*3	kW	96.0		
			kcal/h	82,600		
			BTU/h	327,600		
		Power input	kW	22.11		
Current input	A	37.3-35.4-34.1				
COP	kW/kW	4.34				
Temp. range of heating	Indoor	D.B.	15.0~27.0°C (59~81°F)			
	Outdoor	W.B.	-20.0~15.5°C (-4~60°F)			
Indoor unit connectable	Total capacity		50~150% of outdoor unit capacity			
	Model/Quantity		P15~P250/2~50			
Sound pressure level (measured in anechoic room) *4		dB <A>	68.5/72.5			
Sound power level (measured in anechoic room) *4		dB <A>	86.0/91.5			
Refrigerant piping diameter	High pressure	mm (in.)	28.58 (1-1/8) Brazed			
	Low pressure	mm (in.)	41.28 (1-5/8) Brazed			

Set Model						
Model		PURY-P400YNW-A (-BS)		PURY-P450YNW-A (-BS)		
FAN	Type x Quantity	Propeller fan x 2		Propeller fan x 2		
	Air flow rate	m ³ /min	315		315	
		L/s	5,250		5,250	
		cfm	11,123		11,123	
	Control, Driving mechanism	Inverter-control, Direct-driven by motor		Inverter-control, Direct-driven by motor		
Motor output	kW	0.46 x 2		0.46 x 2		
*5 External static press.	0 Pa (0 mmH ₂ O)		0 Pa (0 mmH ₂ O)			
Compressor	Type	Inverter scroll hermetic compressor		Inverter scroll hermetic compressor		
	Manufacture	AC&R Works, MITSUBISHI ELECTRIC CORPORATION		AC&R Works, MITSUBISHI ELECTRIC CORPORATION		
	Starting method	Inverter		Inverter		
	Motor output	kW	10.9		12.4	
	Case heater	kW	-		-	
	Lubricant	MEL32		MEL32		
External finish		Pre-coated galvanized steel sheets (+powder coating for -BS type) <MUNSELL 5Y 8/1 or similar>		Pre-coated galvanized steel sheets (+powder coating for -BS type) <MUNSELL 5Y 8/1 or similar>		
External dimension H x W x D		mm	1,858 (1,798 without legs) x 1,240 x 740		1,858 (1,798 without legs) x 1,240 x 740	
		in.	73-3/16 (70-13/16 without legs) x 48-7/8 x 29-3/16		73-3/16 (70-13/16 without legs) x 48-7/8 x 29-3/16	
Protection devices	High pressure protection	High pressure sensor, High pressure switch at 4.15 MPa (601 psi)		High pressure sensor, High pressure switch at 4.15 MPa (601 psi)		
	Inverter circuit (COMP./FAN)	Over-heat protection, Over-current protection		Over-heat protection, Over-current protection		
	Compressor	-		-		
	Fan motor	-		-		
Refrigerant	Type x original charge	R410A x 8.0 kg (18 lbs)		R410A x 10.8 kg (24 lbs)		
	Control	Indoor LEV and BC controller				
Net weight	kg (lbs)	273 (602)		293 (646)		
Heat exchanger		Salt-resistant cross fin & copper tube		Salt-resistant cross fin & copper tube		
HIC circuit (HIC: Heat Inter-Changer)		-		-		
Pipe between unit and distributor	High pressure	mm (in.)	22.2 (7/8) Brazed		22.2 (7/8) Brazed	
	Low pressure	mm (in.)	28.58 (1-1/8) Brazed		28.58 (1-1/8) Brazed	
Defrosting method		Auto-defrost mode (Reversed refrigerant cycle)				
Drawing	External	WKS94T753				
	Wiring	WKE94G341		WKE94G341		
Standard attachment	Document	Installation Manual				
	Accessory	-				
Optional parts		Outdoor Twinning kit: CMY-R200VBK4 Joint: CMY-Y102SS-G2, CMY-Y102LS-G2, CMY-R160-J1 Main BC controller: CMB-P108, 1012, 1016V-JA, CMB-P1016V-KA Sub BC controller: CMB-P104, 108V-KB				
Remarks		Details on foundation work, duct work, insulation work, electrical wiring, power source switch, and other items shall be referred to the Installation Manual. Due to continuing improvement, above specifications may be subject to change without notice.				

Notes:		Unit converter
1. Nominal cooling conditions (subject to JIS B8615-2) Indoor: 27°C D.B./19°C W.B. (81°F D.B./66°F W.B.), Outdoor: 35°C D.B./24°C W.B. (95°F D.B./75°F W.B.) Pipe length: 7.5 m (24-9/16 ft.), Level difference: 0 m (0 ft.)		BTU/h = kW x 3,412
2. Nominal heating conditions (subject to JIS B8615-2) Indoor: 20°C D.B. (68°F D.B.), Outdoor: 7°C D.B./6°C W.B. (45°F D.B./43°F W.B.) Pipe length: 7.5 m (24-9/16 ft.), Level difference: 0 m (0 ft.)		cfm = m ³ /min x 35.31
3. Nominal heating conditions (subject to JIS B8615-2) Indoor: 20°C D.B. (68°F D.B.), Outdoor: 7°C D.B./6°C W.B. (45°F D.B./43°F W.B.) Pipe length: 7.5 m (24-9/16 ft.), Level difference: 0 m (0 ft.) Eurovent registered		lbs = kg/0.4536
4. Cooling mode/Heating mode		
5. External static pressure option is available (30 Pa, 60 Pa, 80 Pa/3.1 mmH ₂ O, 6.1 mmH ₂ O, 8.2 mmH ₂ O). Consult your dealer about the specification when setting External static pressure option.		*Above specification data is subject to rounding variation.

1. SPECIFICATIONS

Outdoor units

Model			PURY-P900YSNW-A (-BS)		
Power source			3-phase 4-wire 380-400-415 V 50/60 Hz		
Cooling capacity (Nominal)	*1	kW	101.0		
		kcal/h	86,900		
		BTU/h	344,600		
	Power input	kW	25.76		
	Current input	A	43.4-41.3-39.8		
EER	kW/kW		3.92		
	Indoor	W.B.	15.0~24.0°C (59~75°F)		
Temp. range of cooling	Outdoor	D.B.	-5.0~52.0°C (23~126°F)		
	Heating capacity (Max)			*2	
(Nominal)	*3	kW	113.0		
		kcal/h	97,200		
		BTU/h	385,600		
	Power input	kW	28.03		
	Current input	A	47.3-44.9-43.3		
COP	kW/kW		4.03		
	Indoor	D.B.	15.0~27.0°C (59~81°F)		
Temp. range of heating	Outdoor	W.B.	-20.0~15.5°C (-4~60°F)		
	Indoor unit connectable			50~150% of outdoor unit capacity	
Model/Quantity			P15~P250/2~50		
Sound pressure level (measured in anechoic room) *4			dB <A>		
Sound power level (measured in anechoic room) *4			dB <A>		
Refrigerant piping diameter			mm (in.)		
High pressure			28.58 (1-1/8) Brazed		
Low pressure			41.28 (1-5/8) Brazed		

Set Model			PURY-P450YNW-A (-BS)			PURY-P450YNW-A (-BS)			
Model			Propeller fan x 2			Propeller fan x 2			
FAN	Type x Quantity		315			315			
	Air flow rate	m ³ /min	5,250			5,250			
		L/s	11,123			11,123			
		cfm	Inverter-control, Direct-driven by motor			Inverter-control, Direct-driven by motor			
	Control, Driving mechanism	0.46 x 2			0.46 x 2				
Motor output	kW	0 Pa (0 mmH ₂ O)			0 Pa (0 mmH ₂ O)				
External static press.	Type			Inverter scroll hermetic compressor			Inverter scroll hermetic compressor		
Compressor	Manufacture		AC&R Works, MITSUBISHI ELECTRIC CORPORATION			AC&R Works, MITSUBISHI ELECTRIC CORPORATION			
	Starting method		Inverter			Inverter			
	Motor output	kW	12.4			12.4			
	Case heater	kW	-			-			
	Lubricant	MEL32			MEL32				
External finish			Pre-coated galvanized steel sheets (*powder coating for -BS type) <MUNSELL 5Y 8/1 or similar>			Pre-coated galvanized steel sheets (*powder coating for -BS type) <MUNSELL 5Y 8/1 or similar>			
External dimension H x W x D			mm			mm			
			1,858 (1,798 without legs) x 1,240 x 740			1,858 (1,798 without legs) x 1,240 x 740			
			in.			in.			
			73-3/16 (70-13/16 without legs) x 48-7/8 x 29-3/16			73-3/16 (70-13/16 without legs) x 48-7/8 x 29-3/16			
Protection devices	High pressure protection		High pressure sensor, High pressure switch at 4.15 MPa (601 psi)			High pressure sensor, High pressure switch at 4.15 MPa (601 psi)			
	Inverter circuit (COMP./FAN)		Over-heat protection, Over-current protection			Over-heat protection, Over-current protection			
	Compressor		-			-			
	Fan motor		-			-			
Refrigerant	Type x original charge		R410A x 10.8 kg (24 lbs)			R410A x 10.8 kg (24 lbs)			
	Control		Indoor LEV and BC controller			Indoor LEV and BC controller			
Net weight		kg (lbs)	293 (646)			293 (646)			
Heat exchanger			Salt-resistant cross fin & copper tube			Salt-resistant cross fin & copper tube			
HIC circuit (HIC: Heat Inter-Changer)			-			-			
Pipe between unit and distributor	High pressure	mm (in.)	22.2 (7/8) Brazed			22.2 (7/8) Brazed			
	Low pressure	mm (in.)	28.58 (1-1/8) Brazed			28.58 (1-1/8) Brazed			
Defrosting method			Auto-defrost mode (Reversed refrigerant cycle)			Auto-defrost mode (Reversed refrigerant cycle)			
Drawing	External		WKS94T753			WKS94T753			
	Wiring		WKE94G341			WKE94G341			
Standard attachment	Document		Installation Manual			Installation Manual			
	Accessory		-			-			
Optional parts			Outdoor Twinning kit: CMY-R200VBK4 Joint: CMY-Y102SS-G2, CMY-Y102LS-G2, CMY-R160-J1 Main BC controller: CMB-P108, 1012, 1016V-JA, CMB-P1016V-KA Sub BC controller: CMB-P104, 108V-KB			Outdoor Twinning kit: CMY-R200VBK4 Joint: CMY-Y102SS-G2, CMY-Y102LS-G2, CMY-R160-J1 Main BC controller: CMB-P108, 1012, 1016V-JA, CMB-P1016V-KA Sub BC controller: CMB-P104, 108V-KB			
Remarks			Details on foundation work, duct work, insulation work, electrical wiring, power source switch, and other items shall be referred to the Installation Manual. Due to continuing improvement, above specifications may be subject to change without notice.			Details on foundation work, duct work, insulation work, electrical wiring, power source switch, and other items shall be referred to the Installation Manual. Due to continuing improvement, above specifications may be subject to change without notice.			

Notes:		Unit converter	
1. Nominal cooling conditions (subject to JIS B8615-2) Indoor: 27°C D.B./19°C W.B. (81°F D.B./66°F W.B.), Outdoor: 35°C D.B./24°C W.B. (95°F D.B./75°F W.B.) Pipe length: 7.5 m (24-9/16 ft.), Level difference: 0 m (0 ft.)		BTU/h	=kW x 3,412
2. Nominal heating conditions (subject to JIS B8615-2) Indoor: 20°C D.B. (68°F D.B.), Outdoor: 7°C D.B./6°C W.B. (45°F D.B./43°F W.B.) Pipe length: 7.5 m (24-9/16 ft.), Level difference: 0 m (0 ft.)		cfm	=m ³ /min x 35.31
3. Nominal heating conditions (subject to JIS B8615-2) Indoor: 20°C D.B. (68°F D.B.), Outdoor: 7°C D.B./6°C W.B. (45°F D.B./43°F W.B.) Pipe length: 7.5 m (24-9/16 ft.), Level difference: 0 m (0 ft.) Eurovent registered		lbs	=kg/0.4536
4. Cooling mode/Heating mode			
5. External static pressure option is available (30 Pa, 60 Pa, 80 Pa/3.1 mmH ₂ O, 6.1 mmH ₂ O, 8.2 mmH ₂ O). Consult your dealer about the specification when setting External static pressure option.		*Above specification data is subject to rounding variation.	

PURY-P-Y(S)NW-A

1. SPECIFICATIONS

Outdoor units

Model			PURY-P950YSNW-A (-BS)			
Power source			3-phase 4-wire 380-400-415 V 50/60 Hz			
Cooling capacity (Nominal)	*1	kW	108.0			
		kcal/h	92,900			
		BTU/h	368,500			
	Power input	kW	26.40			
	Current input	A	44.5-42.3-40.8			
Temp. range of cooling	Indoor	W.B.	15.0~24.0°C (59~75°F)			
	Outdoor	D.B.	-5.0~52.0°C (23~126°F)			
Heating capacity (Max)	*2	kW	119.5			
		kcal/h	102,800			
		BTU/h	407,700			
	Power input	kW	29.79			
	Current input	A	50.2-47.7-46.0			
	COP	kW/kW	4.01			
	(Nominal)	*3	kW	108.0		
			kcal/h	92,900		
			BTU/h	368,500		
		Power input	kW	24.15		
Current input	A	40.7-38.7-37.3				
COP	kW/kW	4.47				
Temp. range of heating	Indoor	D.B.	15.0~27.0°C (59~81°F)			
	Outdoor	W.B.	-20.0~15.5°C (-4~60°F)			
Indoor unit connectable	Total capacity		50~150% of outdoor unit capacity			
	Model/Quantity		P15~P250/2~50			
Sound pressure level (measured in anechoic room) *4		dB <A>	68.0/71.5			
Sound power level (measured in anechoic room) *4		dB <A>	85.5/90.5			
Refrigerant piping diameter	High pressure	mm (in.)	28.58 (1-1/8) Brazed			
	Low pressure	mm (in.)	41.28 (1-5/8) Brazed			

Set Model						
Model		PURY-P450YNW-A (-BS)		PURY-P500YNW-A (-BS)		
FAN	Type x Quantity		Propeller fan x 2		Propeller fan x 2	
	Air flow rate	m ³ /min	315		295	
		L/s	5,250		4,917	
		cfm	11,123		10,416	
	Control, Driving mechanism		Inverter-control, Direct-driven by motor		Inverter-control, Direct-driven by motor	
Motor output	kW	0.46 x 2		0.92 x 2		
*5	External static press.		0 Pa (0 mmH ₂ O)		0 Pa (0 mmH ₂ O)	
Compressor	Type		Inverter scroll hermetic compressor		Inverter scroll hermetic compressor	
	Manufacture		AC&R Works, MITSUBISHI ELECTRIC CORPORATION		AC&R Works, MITSUBISHI ELECTRIC CORPORATION	
	Starting method		Inverter		Inverter	
	Motor output	kW	12.4		13.0	
	Case heater	kW	-		-	
	Lubricant		MEL32		MEL32	
External finish		Pre-coated galvanized steel sheets (+powder coating for -BS type) <MUNSELL 5Y 8/1 or similar>		Pre-coated galvanized steel sheets (+powder coating for -BS type) <MUNSELL 5Y 8/1 or similar>		
External dimension H x W x D		mm	1,858 (1,798 without legs) x 1,240 x 740		1,858 (1,798 without legs) x 1,750 x 740	
		in.	73-3/16 (70-13/16 without legs) x 48-7/8 x 29-3/16		73-3/16 (70-13/16 without legs) x 68-15/16 x 29-3/16	
Protection devices	High pressure protection		High pressure sensor, High pressure switch at 4.15 MPa (601 psi)		High pressure sensor, High pressure switch at 4.15 MPa (601 psi)	
	Inverter circuit (COMP./FAN)		Over-heat protection, Over-current protection		Over-heat protection, Over-current protection	
	Compressor		-		-	
	Fan motor		-		-	
Refrigerant	Type x original charge		R410A x 10.8 kg (24 lbs)		R410A x 10.8 kg (24 lbs)	
	Control		Indoor LEV and BC controller			
Net weight	kg (lbs)	293 (646)		337 (743)		
Heat exchanger		Salt-resistant cross fin & copper tube		Salt-resistant cross fin & copper tube		
HIC circuit (HIC: Heat Inter-Changer)		-		-		
Pipe between unit and distributor	High pressure	mm (in.)	22.2 (7/8) Brazed		22.2 (7/8) Brazed	
	Low pressure	mm (in.)	28.58 (1-1/8) Brazed		28.58 (1-1/8) Brazed	
Defrosting method		Auto-defrost mode (Reversed refrigerant cycle)				
Drawing	External		WKS94T754			
	Wiring		WKE94G341		WKE94G342	
Standard attachment	Document		Installation Manual			
	Accessory		-			
Optional parts		Outdoor Twinning kit: CMY-R200VBK4 Joint: CMY-Y102SS-G2, CMY-Y102LS-G2, CMY-R160-J1 Main BC controller: CMB-P1016V-KA Sub BC controller: CMB-P104, 108V-KB				
Remarks		Details on foundation work, duct work, insulation work, electrical wiring, power source switch, and other items shall be referred to the Installation Manual. Due to continuing improvement, above specifications may be subject to change without notice.				

Notes:		Unit converter
1. Nominal cooling conditions (subject to JIS B8615-2) Indoor: 27°C D.B./19°C W.B. (81°F D.B./66°F W.B.), Outdoor: 35°C D.B./24°C W.B. (95°F D.B./75°F W.B.) Pipe length: 7.5 m (24-9/16 ft.), Level difference: 0 m (0 ft.)		BTU/h = kW x 3,412
2. Nominal heating conditions (subject to JIS B8615-2) Indoor: 20°C D.B. (68°F D.B.), Outdoor: 7°C D.B./6°C W.B. (45°F D.B./43°F W.B.) Pipe length: 7.5 m (24-9/16 ft.), Level difference: 0 m (0 ft.)		cfm = m ³ /min x 35.31
3. Nominal heating conditions (subject to JIS B8615-2) Indoor: 20°C D.B. (68°F D.B.), Outdoor: 7°C D.B./6°C W.B. (45°F D.B./43°F W.B.) Pipe length: 7.5 m (24-9/16 ft.), Level difference: 0 m (0 ft.) Eurovent registered		lbs = kg/0.4536
4. Cooling mode/Heating mode		
5. External static pressure option is available (30 Pa, 60 Pa, 80 Pa/3.1 mmH ₂ O, 6.1 mmH ₂ O, 8.2 mmH ₂ O). Consult your dealer about the specification when setting External static pressure option.		*Above specification data is subject to rounding variation.

1. SPECIFICATIONS

Outdoor units

Model			PURY-P1000YSNW-A (-BS)		
Power source			3-phase 4-wire 380-400-415 V 50/60 Hz		
Cooling capacity (Nominal)	*1	kW	113.0		
		kcal/h	97,200		
		BTU/h	385,600		
	Power input	kW	26.45		
	Current input	A	44.6-42.4-40.8		
	EER	kW/kW	4.27		
Temp. range of cooling	Indoor	W.B.	15.0~24.0°C (59~75°F)		
	Outdoor	D.B.	-5.0~52.0°C (23~126°F)		
Heating capacity (Max)	*2	kW	127.0		
		kcal/h	109,200		
		BTU/h	433,300		
	Power input	kW	31.74		
	Current input	A	53.5-50.9-49.0		
	COP	kW/kW	4.00		
	(Nominal)	*3	kW	113.0	
			kcal/h	97,200	
			BTU/h	385,600	
		Power input	kW	25.16	
Current input	A	42.4-40.3-38.8			
COP	kW/kW	4.49			
Temp. range of heating	Indoor	D.B.	15.0~27.0°C (59~81°F)		
	Outdoor	W.B.	-20.0~15.5°C (-4~60°F)		
Indoor unit connectable	Total capacity		50~150% of outdoor unit capacity		
	Model/Quantity		P15~P250/2~50		
Sound pressure level (measured in anechoic room) *4		dB <A>	66.5/67.5		
Sound power level (measured in anechoic room) *4		dB <A>	85.0/87.0		
Refrigerant piping diameter	High pressure	mm (in.)	28.58 (1-1/8) Brazed		
	Low pressure	mm (in.)	41.28 (1-5/8) Brazed		

Set Model			PURY-P500YNW-A (-BS)		PURY-P500YNW-A (-BS)	
Model			PURY-P500YNW-A (-BS)		PURY-P500YNW-A (-BS)	
FAN	Type x Quantity		Propeller fan x 2		Propeller fan x 2	
	Air flow rate	m ³ /min	295		295	
		L/s	4,917		4,917	
		cfm	10,416		10,416	
	Control, Driving mechanism		Inverter-control, Direct-driven by motor		Inverter-control, Direct-driven by motor	
	Motor output	kW	0.92 x 2		0.92 x 2	
*5 External static press.		0 Pa (0 mmH ₂ O)		0 Pa (0 mmH ₂ O)		
Compressor	Type		Inverter scroll hermetic compressor		Inverter scroll hermetic compressor	
	Manufacture		AC&R Works, MITSUBISHI ELECTRIC CORPORATION		AC&R Works, MITSUBISHI ELECTRIC CORPORATION	
	Starting method		Inverter		Inverter	
	Motor output	kW	13.0		13.0	
	Case heater	kW	-		-	
	Lubricant		MEL32		MEL32	
External finish			Pre-coated galvanized steel sheets (+powder coating for -BS type) <MUNSELL 5Y 8/1 or similar>		Pre-coated galvanized steel sheets (+powder coating for -BS type) <MUNSELL 5Y 8/1 or similar>	
External dimension H x W x D			mm 1,858 (1,798 without legs) x 1,750 x 740 73-3/16 (70-13/16 without legs) x 68-15/16 x 29-3/16		mm 1,858 (1,798 without legs) x 1,750 x 740 73-3/16 (70-13/16 without legs) x 68-15/16 x 29-3/16	
Protection devices	High pressure protection		High pressure sensor, High pressure switch at 4.15 MPa (601 psi)		High pressure sensor, High pressure switch at 4.15 MPa (601 psi)	
	Inverter circuit (COMP./FAN)		Over-heat protection, Over-current protection		Over-heat protection, Over-current protection	
	Compressor		-		-	
	Fan motor		-		-	
Refrigerant	Type x original charge		R410A x 10.8 kg (24 lbs)		R410A x 10.8 kg (24 lbs)	
	Control		Indoor LEV and BC controller			
Net weight		kg (lbs)	337 (743)		337 (743)	
Heat exchanger			Salt-resistant cross fin & copper tube		Salt-resistant cross fin & copper tube	
HIC circuit (HIC: Heat Inter-Changer)			-			
Pipe between unit and distributor	High pressure	mm (in.)	22.2 (7/8) Brazed		22.2 (7/8) Brazed	
	Low pressure	mm (in.)	28.58 (1-1/8) Brazed		28.58 (1-1/8) Brazed	
Defrosting method			Auto-defrost mode (Reversed refrigerant cycle)			
Drawing	External		WKS94T755			
	Wiring		WKE94G342		WKE94G342	
Standard attachment	Document		Installation Manual			
	Accessory		-			
Optional parts			Outdoor Twinning kit: CMY-R200VBK4 Joint: CMY-Y102SS-G2, CMY-Y102LS-G2, CMY-R160-J1 Main BC controller: CMB-P1016V-KA Sub BC controller: CMB-P104, 108V-KB			
Remarks			Details on foundation work, duct work, insulation work, electrical wiring, power source switch, and other items shall be referred to the Installation Manual. Due to continuing improvement, above specifications may be subject to change without notice.			

Notes:	Unit converter
1. Nominal cooling conditions (subject to JIS B8615-2) Indoor: 27°C D.B./19°C W.B. (81°F D.B./66°F W.B.), Outdoor: 35°C D.B./24°C W.B. (95°F D.B./75°F W.B.) Pipe length: 7.5 m (24-9/16 ft.), Level difference: 0 m (0 ft.)	BTU/h = kW x 3,412
2. Nominal heating conditions (subject to JIS B8615-2) Indoor: 20°C D.B. (68°F D.B.), Outdoor: 7°C D.B./6°C W.B. (45°F D.B./43°F W.B.) Pipe length: 7.5 m (24-9/16 ft.), Level difference: 0 m (0 ft.)	cfm = m ³ /min x 35.31
3. Nominal heating conditions (subject to JIS B8615-2) Indoor: 20°C D.B. (68°F D.B.), Outdoor: 7°C D.B./6°C W.B. (45°F D.B./43°F W.B.) Pipe length: 7.5 m (24-9/16 ft.), Level difference: 0 m (0 ft.) Eurovent registered	lbs = kg/0.4536
4. Cooling mode/Heating mode	
5. External static pressure option is available (30 Pa, 60 Pa, 80 Pa/3.1 mmH ₂ O, 6.1 mmH ₂ O, 8.2 mmH ₂ O). Consult your dealer about the specification when setting External static pressure option.	*Above specification data is subject to rounding variation.

PURY-P-Y(S)NW-A

1. SPECIFICATIONS

Outdoor units

Model			PURY-P1050YSNW-A (-BS)		
Power source			3-phase 4-wire 380-400-415 V 50/60 Hz		
Cooling capacity (Nominal)	*1	kW	118.0		
		kcal/h	101,500		
		BTU/h	402,600		
	Power input	kW	29.20		
	Current input	A	49.2-46.8-45.1		
Temp. range of cooling	Indoor	W.B.	15.0~24.0°C (59~75°F)		
	Outdoor	D.B.	-5.0~52.0°C (23~126°F)		
Heating capacity (Max)	*2	kW	132.0		
		kcal/h	113,500		
		BTU/h	450,400		
	Power input	kW	34.10		
	Current input	A	57.5-54.6-52.7		
	COP	kW/kW	3.87		
	(Nominal)	*3	kW	118.0	
			kcal/h	101,500	
			BTU/h	402,600	
		Power input	kW	27.05	
Current input	A	45.6-43.3-41.8			
COP	kW/kW	4.36			
Temp. range of heating	Indoor	D.B.	15.0~27.0°C (59~81°F)		
	Outdoor	W.B.	-20.0~15.5°C (-4~60°F)		
Indoor unit connectable	Total capacity		50~150% of outdoor unit capacity		
	Model/Quantity		P15~P250/3~50		
Sound pressure level (measured in anechoic room) *4		dB <A>	68.0/73.0		
Sound power level (measured in anechoic room) *4		dB <A>	86.0/92.0		
Refrigerant piping diameter	High pressure	mm (in.)	34.93 (1-3/8) Brazed		
	Low pressure	mm (in.)	41.28 (1-5/8) Brazed		

Set Model			PURY-P500YNW-A (-BS)		PURY-P550YNW-A (-BS)	
Model			PURY-P500YNW-A (-BS)		PURY-P550YNW-A (-BS)	
FAN	Type x Quantity		Propeller fan x 2		Propeller fan x 2	
	Air flow rate	m ³ /min	295		410	
		L/s	4,917		6,833	
		cfm	10,416		14,477	
	Control, Driving mechanism		Inverter-control, Direct-driven by motor		Inverter-control, Direct-driven by motor	
Motor output	kW	0.92 x 2		0.92 x 2		
*5 External static press.		0 Pa (0 mmH ₂ O)		0 Pa (0 mmH ₂ O)		
Compressor	Type		Inverter scroll hermetic compressor		Inverter scroll hermetic compressor	
	Manufacture		AC&R Works, MITSUBISHI ELECTRIC CORPORATION		AC&R Works, MITSUBISHI ELECTRIC CORPORATION	
	Starting method		Inverter		Inverter	
	Motor output	kW	13.0		14.3	
	Case heater	kW	-		-	
Lubricant		MEL32		MEL32		
External finish			Pre-coated galvanized steel sheets (+powder coating for -BS type) <MUNSELL 5Y 8/1 or similar>		Pre-coated galvanized steel sheets (+powder coating for -BS type) <MUNSELL 5Y 8/1 or similar>	
External dimension H x W x D			mm 1,858 (1,798 without legs) x 1,750 x 740 73-3/16 (70-13/16 without legs) x 68-15/16 x 29-3/16		mm 1,858 (1,798 without legs) x 1,750 x 740 73-3/16 (70-13/16 without legs) x 68-15/16 x 29-3/16	
Protection devices	High pressure protection		High pressure sensor, High pressure switch at 4.15 MPa (601 psi)		High pressure sensor, High pressure switch at 4.15 MPa (601 psi)	
	Inverter circuit (COMP./FAN)		Over-heat protection, Over-current protection		Over-heat protection, Over-current protection	
	Compressor		-		-	
	Fan motor		-		-	
Refrigerant	Type x original charge		R410A x 10.8 kg (24 lbs)		R410A x 10.8 kg (24 lbs)	
	Control		Indoor LEV and BC controller			
Net weight		kg (lbs)	337 (743)		337 (743)	
Heat exchanger			Salt-resistant cross fin & copper tube		Salt-resistant cross fin & copper tube	
HIC circuit (HIC: Heat Inter-Changer)			-			
Pipe between unit and distributor	High pressure	mm (in.)	22.2 (7/8) Brazed		22.2 (7/8) Brazed	
	Low pressure	mm (in.)	28.58 (1-1/8) Brazed		28.58 (1-1/8) Brazed	
Defrosting method			Auto-defrost mode (Reversed refrigerant cycle)			
Drawing	External		WKS94T755			
	Wiring		WKE94G342		WKE94G342	
Standard attachment	Document		Installation Manual			
	Accessory		-			
Optional parts			Outdoor Twinning kit: CMY-R200VBK4 Joint: CMY-Y102SS-G2, CMY-Y102LS-G2, CMY-R160-J1 Main BC controller: CMB-P1016V-KA Sub BC controller: CMB-P104, 108V-KB			
Remarks			Details on foundation work, duct work, insulation work, electrical wiring, power source switch, and other items shall be referred to the Installation Manual. Due to continuing improvement, above specifications may be subject to change without notice.			

Notes:	Unit converter
1. Nominal cooling conditions (subject to JIS B8615-2) Indoor: 27°C D.B./19°C W.B. (81°F D.B./66°F W.B.), Outdoor: 35°C D.B./24°C W.B. (95°F D.B./75°F W.B.) Pipe length: 7.5 m (24-9/16 ft.), Level difference: 0 m (0 ft.)	BTU/h = kW x 3,412
2. Nominal heating conditions (subject to JIS B8615-2) Indoor: 20°C D.B. (68°F D.B.), Outdoor: 7°C D.B./6°C W.B. (45°F D.B./43°F W.B.) Pipe length: 7.5 m (24-9/16 ft.), Level difference: 0 m (0 ft.)	cfm = m ³ /min x 35.31
3. Nominal heating conditions (subject to JIS B8615-2) Indoor: 20°C D.B. (68°F D.B.), Outdoor: 7°C D.B./6°C W.B. (45°F D.B./43°F W.B.) Pipe length: 7.5 m (24-9/16 ft.), Level difference: 0 m (0 ft.) Eurovent registered	lbs = kg/0.4536
4. Cooling mode/Heating mode	
5. External static pressure option is available (30 Pa, 60 Pa, 80 Pa/3.1 mmH ₂ O, 6.1 mmH ₂ O, 8.2 mmH ₂ O). Consult your dealer about the specification when setting External static pressure option.	*Above specification data is subject to rounding variation.

1. SPECIFICATIONS

Outdoor units

Model			PURY-P1100YSNW-A (-BS)		
Power source			3-phase 4-wire 380-400-415 V 50/60 Hz		
Cooling capacity (Nominal)	*1	kW	124.0		
		kcal/h	106,600		
		BTU/h	423,100		
	Power input	kW	32.54		
	Current input	A	54.9-52.1-50.2		
Temp. range of cooling	Indoor	W.B.	15.0~24.0°C (59~75°F)		
	Outdoor	D.B.	-5.0~52.0°C (23~126°F)		
Heating capacity (Max)	*2	kW	140.0		
		kcal/h	120,400		
		BTU/h	477,700		
	Power input	kW	37.52		
	Current input	A	63.3-60.1-57.9		
(Nominal)	*3	kW	124.0		
		kcal/h	106,600		
		BTU/h	423,100		
	Power input	kW	29.30		
	Current input	A	49.4-46.9-45.2		
Temp. range of heating	Indoor	D.B.	15.0~27.0°C (59~81°F)		
	Outdoor	W.B.	-20.0~15.5°C (-4~60°F)		
Indoor unit connectable	Total capacity		50~150% of outdoor unit capacity		
	Model/Quantity		P15~P250/3~50		
Sound pressure level (measured in anechoic room) *4		dB <A>	69.0/73.0		
Sound power level (measured in anechoic room) *4		dB <A>	86.5/92.0		
Refrigerant piping diameter	High pressure	mm (in.)	34.93 (1-3/8) Brazed		
	Low pressure	mm (in.)	41.28 (1-5/8) Brazed		

Set Model			PURY-P550YNW-A (-BS)			PURY-P550YNW-A (-BS)		
Model			PURY-P550YNW-A (-BS)			PURY-P550YNW-A (-BS)		
FAN	Type x Quantity		Propeller fan x 2			Propeller fan x 2		
	Air flow rate	m ³ /min	410			410		
		L/s	6,833			6,833		
		cfm	14,477			14,477		
	Control, Driving mechanism		Inverter-control, Direct-driven by motor			Inverter-control, Direct-driven by motor		
*5	Motor output		0.92 x 2			0.92 x 2		
	External static press.		0 Pa (0 mmH ₂ O)			0 Pa (0 mmH ₂ O)		
	Type		Inverter scroll hermetic compressor			Inverter scroll hermetic compressor		
	Manufacture		AC&R Works, MITSUBISHI ELECTRIC CORPORATION			AC&R Works, MITSUBISHI ELECTRIC CORPORATION		
	Starting method		Inverter			Inverter		
Compressor	Motor output		14.3			14.3		
	Case heater		-			-		
	Lubricant		MEL32			MEL32		
	External finish		Pre-coated galvanized steel sheets (+powder coating for -BS type) <MUNSELL 5Y 8/1 or similar>			Pre-coated galvanized steel sheets (+powder coating for -BS type) <MUNSELL 5Y 8/1>		
	External dimension H x W x D		1,858 (1,798 without legs) x 1,750 x 740 73-3/16 (70-13/16 without legs) x 68-15/16 x 29-3/16			1,858 (1,798 without legs) x 1,750 x 740 73-3/16 (70-13/16 without legs) x 68-15/16 x 29-3/16		
Protection devices	High pressure protection		High pressure sensor, High pressure switch at 4.15 MPa (601 psi)			High pressure sensor, High pressure switch at 4.15 MPa (601 psi)		
	Inverter circuit (COMP./FAN)		Over-heat protection, Over-current protection			Over-heat protection, Over-current protection		
	Compressor		-			-		
	Fan motor		-			-		
Refrigerant	Type x original charge		R410A x 10.8 kg (24 lbs)			R410A x 10.8 kg (24 lbs)		
	Control		Indoor LEV and BC controller			Indoor LEV and BC controller		
Net weight		kg (lbs)	337 (743)			337 (743)		
Heat exchanger		Salt-resistant cross fin & copper tube			Salt-resistant cross fin & copper tube			
HIC circuit (HIC: Heat Inter-Changer)		-			-			
Pipe between unit and distributor	High pressure	mm (in.)	22.2 (7/8) Brazed			22.2 (7/8) Brazed		
	Low pressure	mm (in.)	28.58 (1-1/8) Brazed			28.58 (1-1/8) Brazed		
Defrosting method		Auto-defrost mode (Reversed refrigerant cycle)			Auto-defrost mode (Reversed refrigerant cycle)			
Drawing	External		WKS94T755			WKS94T755		
	Wiring		WKE94G342			WKE94G342		
Standard attachment	Document		Installation Manual			Installation Manual		
	Accessory		-			-		
Optional parts		Outdoor Twinning kit: CMY-R200VBK4 Joint: CMY-Y102SS-G2, CMY-Y102LS-G2, CMY-R160-J1 Main BC controller: CMB-P1016V-KA Sub BC controller: CMB-P104, 108V-KB			Outdoor Twinning kit: CMY-R200VBK4 Joint: CMY-Y102SS-G2, CMY-Y102LS-G2, CMY-R160-J1 Main BC controller: CMB-P1016V-KA Sub BC controller: CMB-P104, 108V-KB			
Remarks		Details on foundation work, duct work, insulation work, electrical wiring, power source switch, and other items shall be referred to the Installation Manual. Due to continuing improvement, above specifications may be subject to change without notice.			Details on foundation work, duct work, insulation work, electrical wiring, power source switch, and other items shall be referred to the Installation Manual. Due to continuing improvement, above specifications may be subject to change without notice.			

Notes:		Unit converter	
1. Nominal cooling conditions (subject to JIS B8615-2) Indoor: 27°C D.B./19°C W.B. (81°F D.B./66°F W.B.), Outdoor: 35°C D.B./24°C W.B. (95°F D.B./75°F W.B.) Pipe length: 7.5 m (24-9/16 ft.), Level difference: 0 m (0 ft.)		BTU/h	=kW x 3,412
2. Nominal heating conditions (subject to JIS B8615-2) Indoor: 20°C D.B. (68°F D.B.), Outdoor: 7°C D.B./6°C W.B. (45°F D.B./43°F W.B.) Pipe length: 7.5 m (24-9/16 ft.), Level difference: 0 m (0 ft.)		cfm	=m ³ /min x 35.31
3. Nominal heating conditions (subject to JIS B8615-2) Indoor: 20°C D.B. (68°F D.B.), Outdoor: 7°C D.B./6°C W.B. (45°F D.B./43°F W.B.) Pipe length: 7.5 m (24-9/16 ft.), Level difference: 0 m (0 ft.) Eurovent registered		lbs	=kg/0.4536
4. Cooling mode/Heating mode			
5. External static pressure option is available (30 Pa, 60 Pa, 80 Pa/3.1 mmH ₂ O, 6.1 mmH ₂ O, 8.2 mmH ₂ O). Consult your dealer about the specification when setting External static pressure option.		*Above specification data is subject to rounding variation.	

PURY-P-Y(S)NW-A

PURY-P200, 250, 300YNW-A(-BS)

Unit: mm

- Note 1. Please refer to the next page for information regarding necessary spacing around the unit and foundation work.
 2. The detachable leg can be removed at site.
 3. At brazing of pipes, wrap the refrigerant service valve with wet cloth and keep the temperature of refrigerant service valve under 120°C.

Model	Connecting pipe specifications			
	Refrigerant pipe		Service valve	
	High pressure	Low pressure	High pressure	Low pressure
P200	ø15.88 Brazed*1	ø19.05 Brazed*1	ø22.2	ø28.58
P250	ø19.05 Brazed*1	ø22.2 Brazed*1		
P300				

*1 Connect the refrigerant pipe to the service valve according to the Installation Manual.

NO.	Usage	Specifications
①	For pipes	Front through hole 148 × 84 Knockout hole
②		Bottom through hole 150 × 94 Knockout hole
③	For wires	Front through hole ø65 or ø40 Knockout hole
④		Front through hole ø52 or ø27 Knockout hole
⑤		Bottom through hole ø65 Knockout hole
⑥		Bottom through hole ø52 Knockout hole
⑦	For transmission cables	Front through hole ø34 Knockout hole
⑧		Bottom through hole ø34 Knockout hole

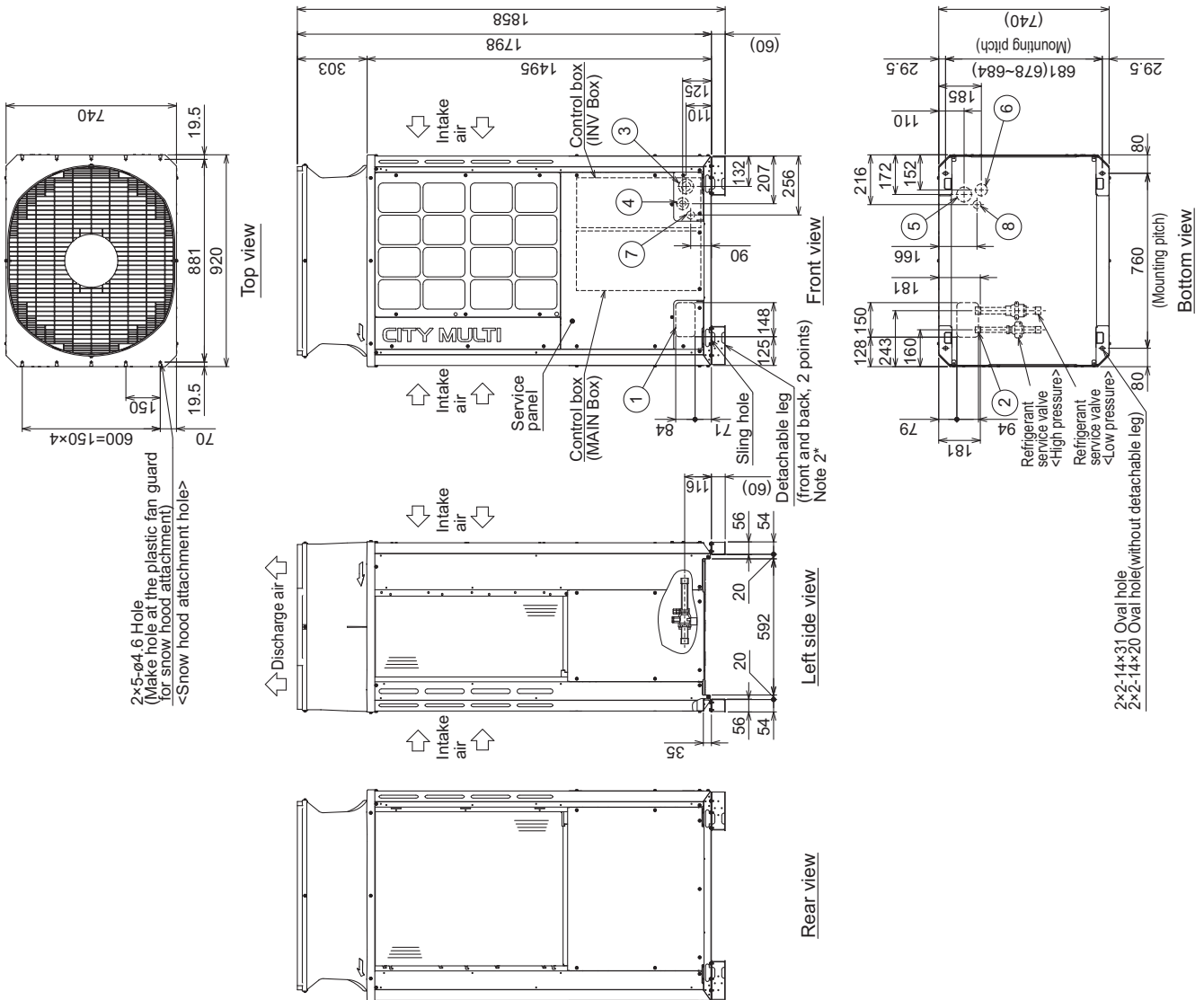

PURY-P-Y(S)NW-A

1. Required space around the unit

● In case of single installation

① Secure enough space around the unit as shown in the figure below.

· With a space of at least 100mm to the wall on the back of the unit

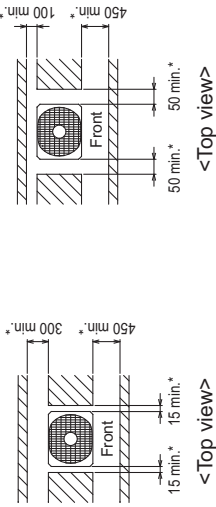

② When the height of the walls on the front, back or on the sides <H> exceeds the wall height limit as defined below add the height that exceeds the height limit <h> to the figures that are marked with an asterisk.

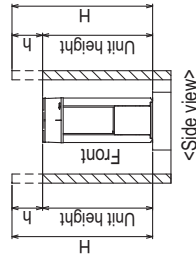

<Wall height limit> Front :Up to the unit height
Back :Up to the unit height
Side :Up to the unit height

2. Foundation work

- ① Take into consideration the surface strength, water drainage route, piping route, and wiring route when preparing the installation site.
<Note that the drain water comes out of the unit during operation.>
- ② Build the foundation in such way that the corner of the installation leg is securely supported as shown in the right figure.(Fig.A,B)
When using a rubber isolating cushion, please ensure it is large enough to cover the entire width of each of the unit's legs.
- ③ The protrusion length of the anchor bolt must not exceed 30mm.(Fig.A,B)
- ④ Use four fixing plates as shown in the right figure <field supply required> when using post-installed anchor bolts.(Fig.C,D)
- ⑤ To prevent small animals and water and snow from entering the unit and damaging its parts, close the gap around the edges of through holes for pipes and wires with filler plates <field supply required>.
- ⑥ When the pipes or cables are routed at the bottom of the unit, make sure that the through hole at the base of the unit does not get blocked with the installation base.
- ⑦ Refer to the Installation Manual when installing units on an installation base.

PURY-P200, 250, 300YNW-A(-BS)

Unit: mm

● In case of collective installation

① When multiple units are installed adjacent to each other, secure enough space to allow for air circulation and walkway between groups of units as shown in the figures below.

② At least two sides must be left open.

③ As with the single installation, add the height that exceeds the height limit <h> to the figures that are marked with an asterisk.

④ If there is a wall at both the front and the rear of the unit, install up to six units consecutively in the side direction and provide a space of 1000mm or more as inlet space/ passage space for each six units.

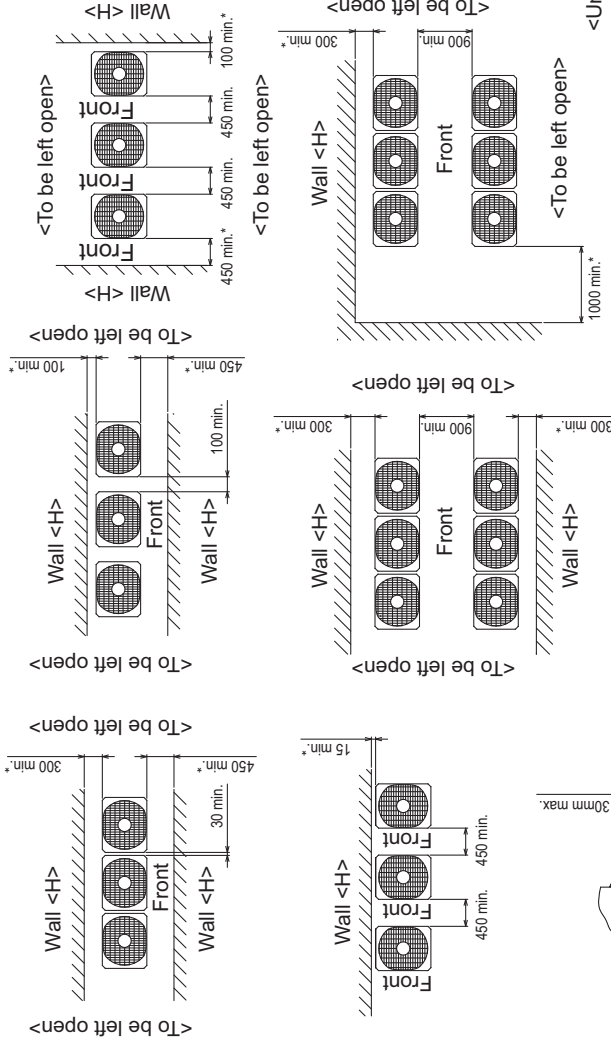
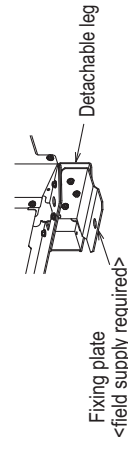
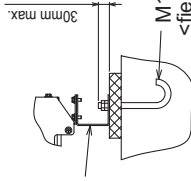
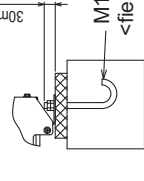

Fig.A (without detachable legs)

Fig.C (without detachable legs)

Fig.D (with detachable legs)



PURY-P350, 400, 450YNW-A(-BS)

Unit: mm

- Note 1. Please refer to the next page for information regarding necessary spacing around the unit and foundation work.
 2. The detachable leg can be removed at site.
 3. At brazing of pipes, wrap the refrigerant service valve with wet cloth and keep the temperature of refrigerant service valve under 120°C.

Connecting pipe specifications

Model	Refrigerant pipe		Service valve	
	High pressure	Low pressure	High pressure	Low pressure
P350	∅19.05 Brazed *1	∅28.58 Brazed	∅28.58	∅28.58
P400	∅22.2 Brazed *1	∅28.58 Brazed	∅28.58	∅28.58
P450	∅22.2 Brazed *1	∅28.58 Brazed	∅28.58	∅28.58

*1 Connect the refrigerant pipe to the service valve according to the Installation Manual.

NO.	Usage	Specifications
①	For pipes	Front through hole 148 × 84 Knockout hole
②		Bottom through hole 150 × 94 Knockout hole
③	For wires	Front through hole ∅65 or ∅40 Knockout hole
④		Bottom through hole ∅62 or ∅27 Knockout hole
⑤	For transmission cables	Front through hole ∅65 Knockout hole
⑥		Bottom through hole ∅52 Knockout hole
⑦	For transmission cables	Front through hole ∅34 Knockout hole
⑧		Bottom through hole ∅34 Knockout hole

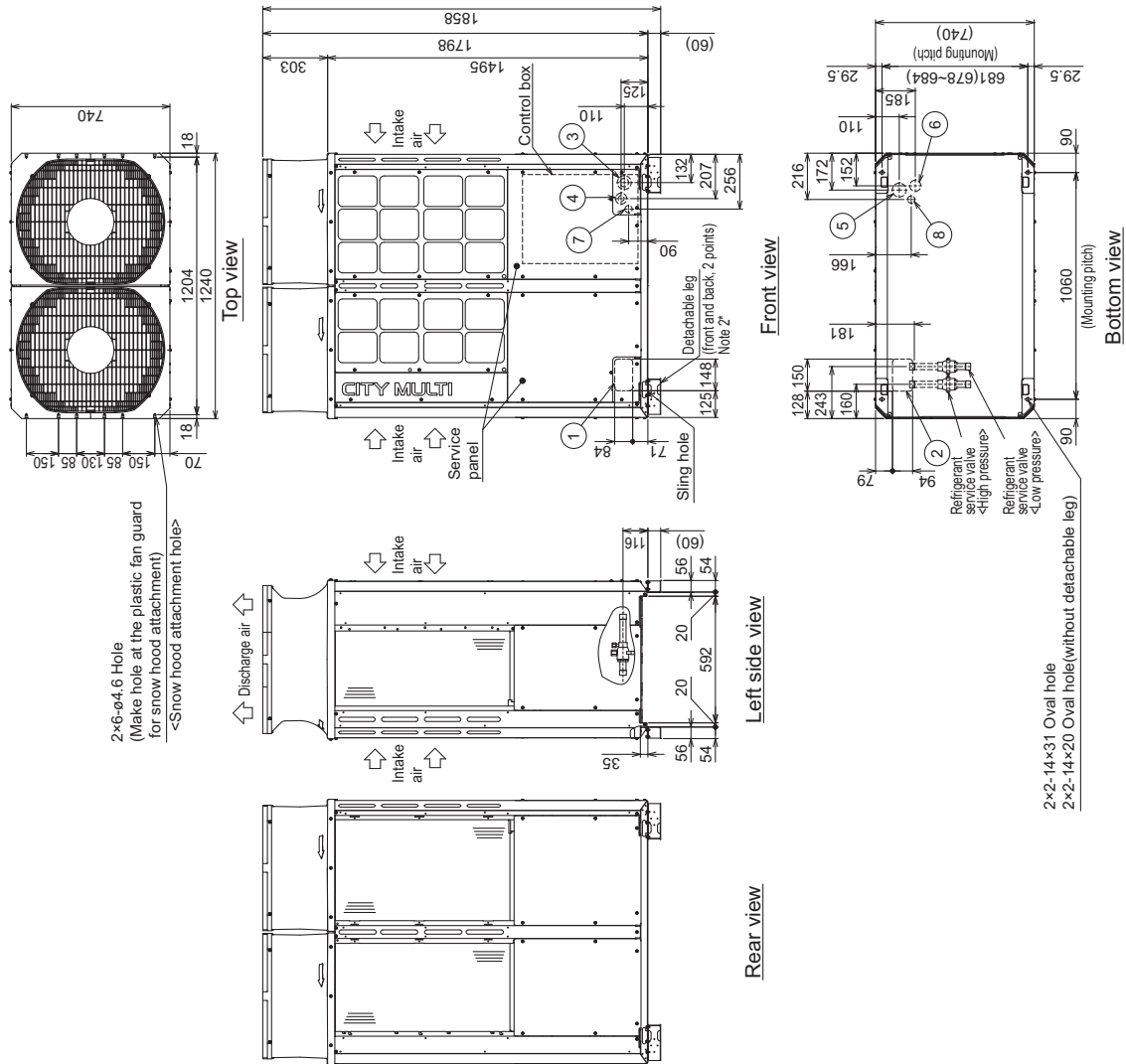

1. Required space around the unit

● In case of single installation

- Secure enough space around the unit as shown in the figure below.
 - With a space of at least 300mm to the wall on the back of the unit

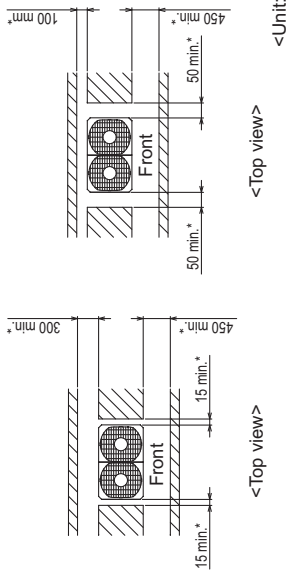

- When the height of the walls on the front, back or on the sides<H> exceeds the wall height limit as defined below add the height that exceeds the height limit <h> to the figures that are marked with an asterisk.

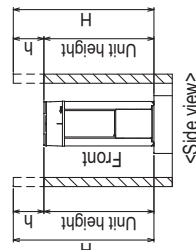

<Wall height limit> Front : Up to the unit height
 Back : Up to the unit height
 Side : Up to the unit height

2. Foundation work

- Take into consideration the surface strength, water drainage route, piping route, and wiring route when preparing the installation site.
 - Note that the drain water comes out of the unit during operation.>
- Build the foundation in such way that the corner of the installation leg is securely supported as shown in the right figure.(Fig.A,B)
 When using a rubber isolating cushion, please ensure it is large enough to cover the entire width of each of the unit's legs.
- The protrusion length of the anchor bolt must not exceed 30mm.(Fig.A,B)
- Use four fixing plates as shown in the right figure <field supply required> when using post-installed anchor bolts.(Fig.C,D)
- To prevent small animals and water and snow from entering the unit and damaging its parts, close the gap around the edges of through holes for pipes and wires with filler plates <field supply required>
- When the pipes or cables are routed at the bottom of the unit, make sure that the through hole at the base of the unit does not get blocked with the installation base.
- Refer to the Installation Manual when installing units on an installation base.

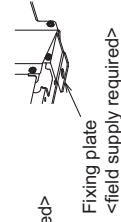
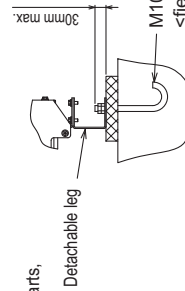
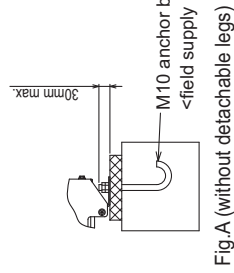

Fig.C (without detachable legs)

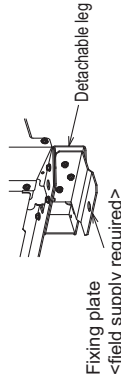
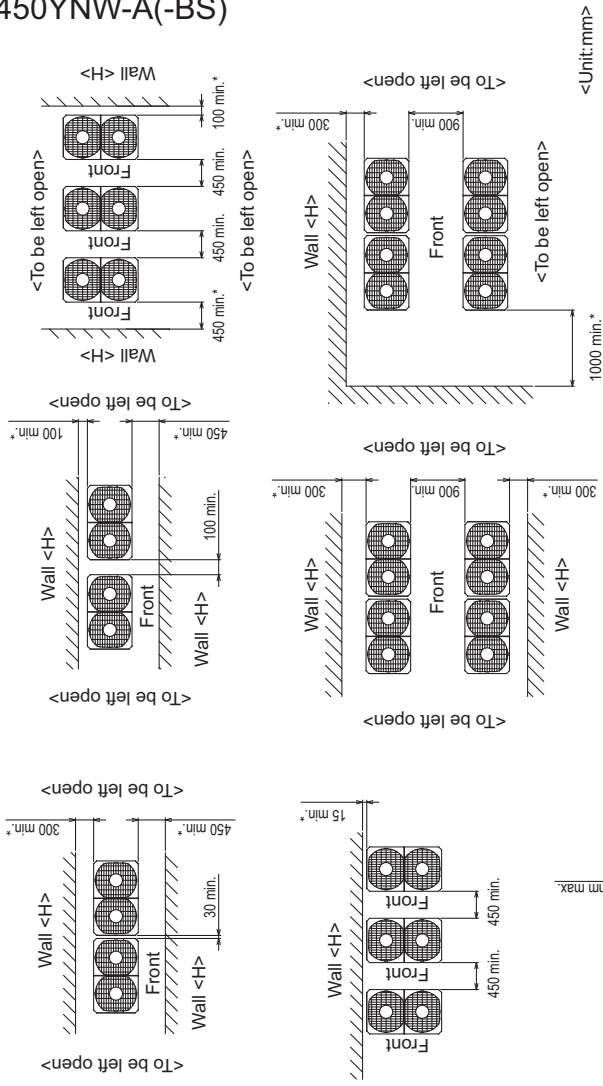

Fig.D (with detachable legs)

● In case of collective installation

- When multiple units are installed adjacent to each other, secure enough space to allow for air circulation and walkway between groups of units as shown in the figures below.
 - At least two sides must be left open.
 - As with the single installation, add the height that exceeds the height limit<h> to the figures that are marked with an asterisk.
 - If there is a wall at both the front and the rear of the unit, install up to six units consecutively in the side direction and provide a space of 1000mm or more as inlet space/ passage space for each six units.



PURY-P350, 400, 450YNW-A(-BS)

2. EXTERNAL DIMENSIONS

Outdoor units

PURY-P500, 550YNW-A(-BS)

Unit: mm

- Note 1. Please refer to the next page for information regarding necessary spacing around the unit and foundation work.
 2. The detachable leg can be removed at site.
 3. At brazing of pipes, wrap the refrigerant service valve with wet cloth and keep the temperature of refrigerant service valve under 120°C.

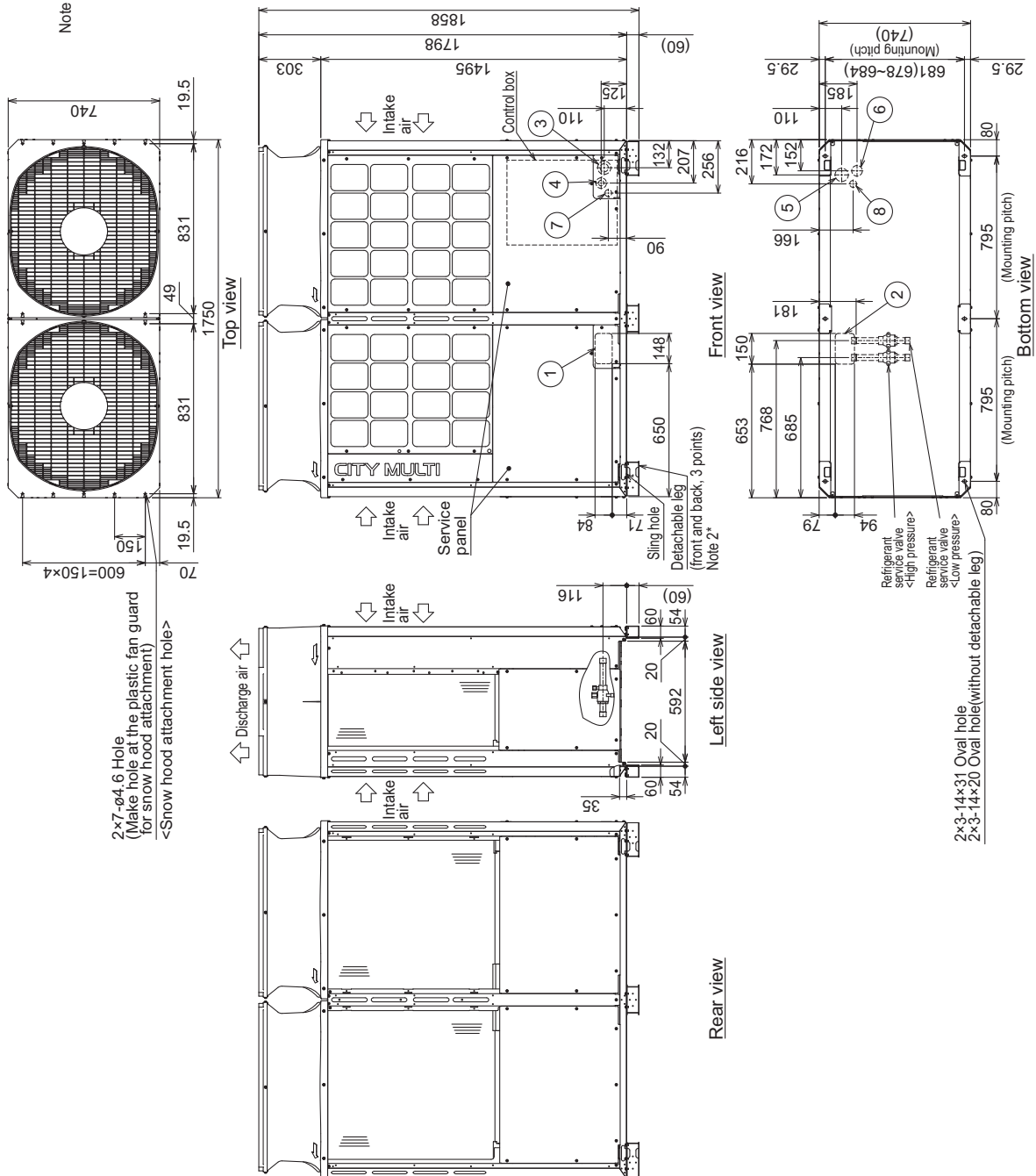

Model	Refrigerant pipe		Diameter	
	High pressure	Low pressure	High pressure	Low pressure
P500	ø22.2 Brazed *1	ø28.58 Brazed	ø28.58	ø28.58
P550	ø22.2 Brazed *1 (ø28.58 Brazed *2)	ø28.58 Brazed	ø28.58	ø28.58

*1 Connect the refrigerant pipe to the service valve according to the Installation Manual.

*2 When the piping length is 65m or longer, use the ø28.58 pipe for the part that exceeds 65m.

NO.	Usage	Specifications
①	Front through hole	148 x 84 Knockout hole
②	Bottom through hole	150 x 94 Knockout hole
③	Front through hole	ø65 or ø40 Knockout hole
④	Front through hole	ø52 or ø27 Knockout hole
⑤	Bottom through hole	ø65 Knockout hole
⑥	Bottom through hole	ø52 Knockout hole
⑦	Front through hole	ø34 Knockout hole
⑧	Bottom through hole	ø34 Knockout hole

PURY-P500, 550YNW-A(-BS)

Unit: mm

1. Required space around the unit

In case of single installation

① Secure enough space around the unit as shown in the figure below.

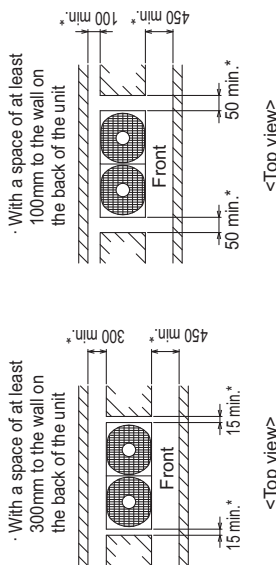

<Top view> <Unit:mm>

② When the height of the walls on the front, back or on the sides <h> exceeds the wall height limit as defined below add the height that exceeds the height limit <h> to the figures that are marked with an asterisk.

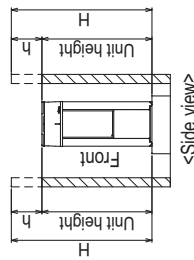

2. Foundation work

- ① Take into consideration the surface strength, water drainage route, piping route, and wiring route when preparing the installation site.
 - <Note that the drain water comes out of the unit during operation.>
- ② Build the foundation in such way that the corner of the installation leg is securely supported as shown in the right figure.(Fig.A,B)
 - When using a rubber isolating cushion, please ensure it is large enough to cover the entire width of each of the unit's legs.
- ③ The protrusion length of the anchor bolt must not exceed 30mm.(Fig.A,B)
- ④ Use four fixing plates as shown in the right figure <field supply required> when using post-installed anchor bolts.(Fig.C,D)
- ⑤ To prevent small animals and water and snow from entering the unit and damaging its parts, close the gap around the edges of through holes for pipes and wires with filler plates <field supply required>.
- ⑥ When the pipes or cables are routed at the bottom of the unit, make sure that the through hole at the base of the unit does not get blocked with the installation base.
- ⑦ Refer to the Installation Manual when installing units on an installation base.

In case of collective installation

- ① When multiple units are installed adjacent to each other, secure enough space to allow for air circulation and walkway between groups of units as shown in the figures below.
- ② At least two sides must be left open.
- ③ As with the single installation, add the height that exceeds the height limit <h> to the figures that are marked with an asterisk.
- ④ If there is a wall at both the front and the rear of the unit, install up to three units consecutively in the side direction and provide a space of 1000mm or more as inlet space/ passage space for each three units.

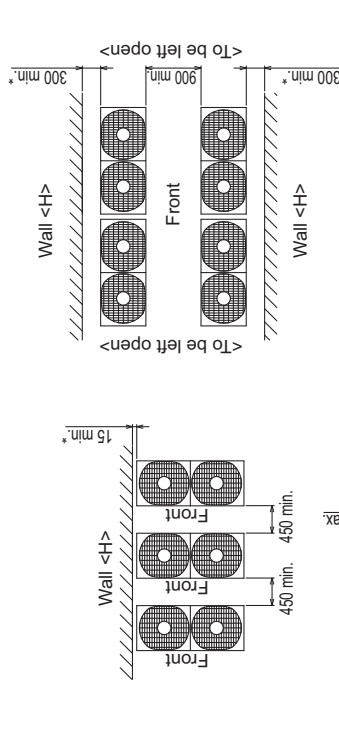
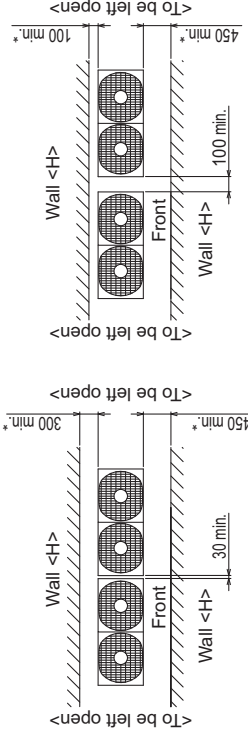

<Unit:mm>

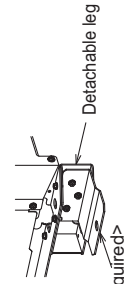

Fig.D (with detachable legs)

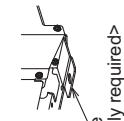

Fig.C (without detachable legs)

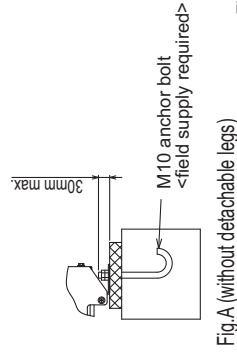

Fig.A (without detachable legs)

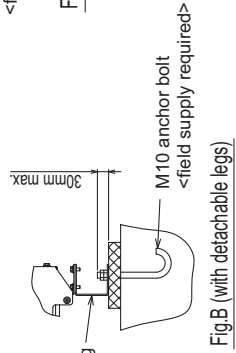

Fig.B (with detachable legs)

2. EXTERNAL DIMENSIONS

Outdoor units

PURY-P400, 450, 500, 550, 600YSNW-A(-BS)

Unit: mm

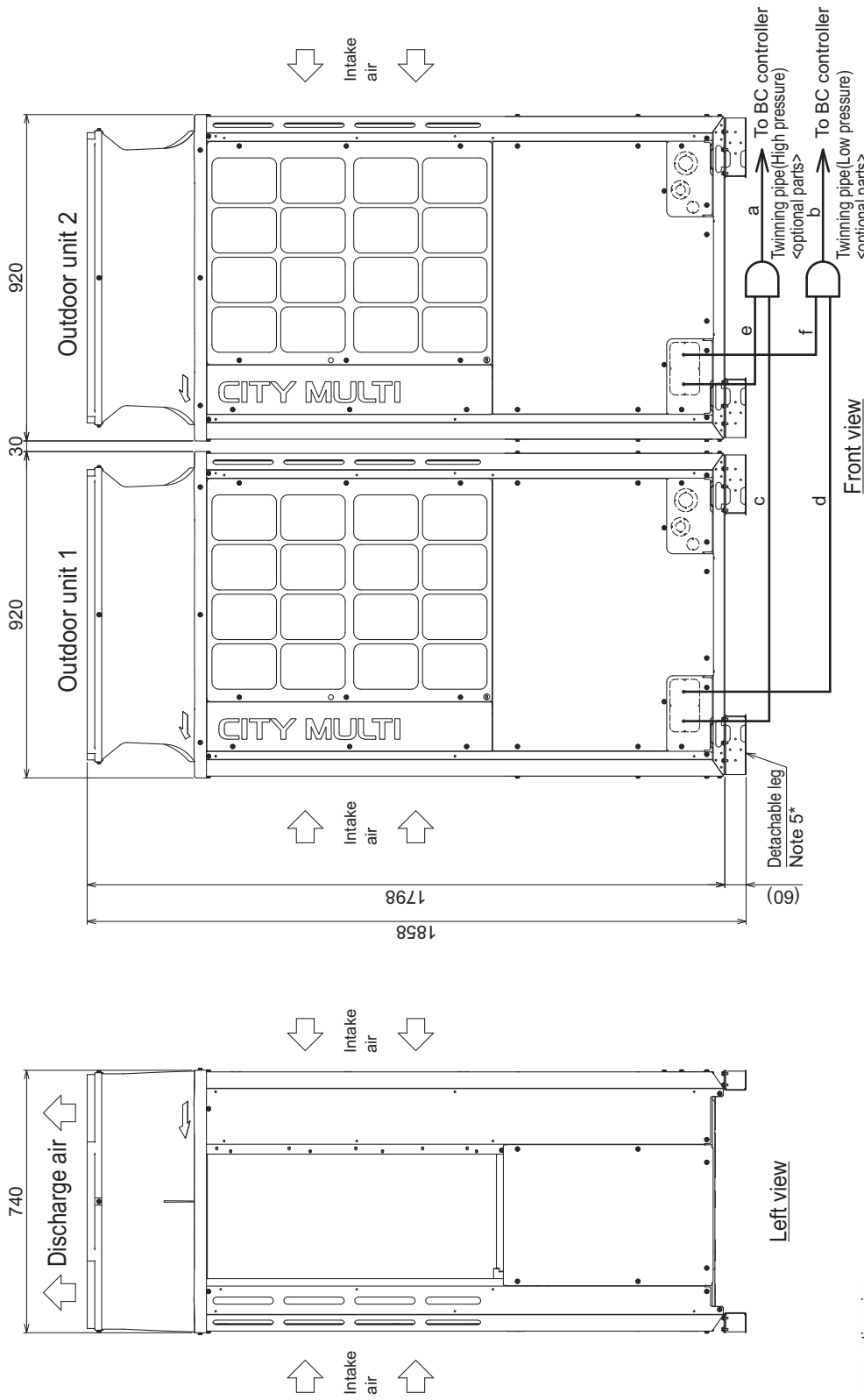

Unit model	High pressure		Low pressure	
	c or e	d or f	c or e	d or f
P200	ø15.88	ø19.05	ø15.88	ø19.05
P250	ø19.05	ø22.2	ø19.05	ø22.2
P300	ø19.05	ø22.2	ø19.05	ø22.2

Package unit name	PURY-P400YSNW-A(-BS)	PURY-P450YSNW-A(-BS)	PURY-P500YSNW-A(-BS)	PURY-P550YSNW-A(-BS)	PURY-P600YSNW-A(-BS)
Outdoor unit 1	PURY-P200YNNW-A(-BS)	PURY-P250YNNW-A(-BS)	PURY-P300YNNW-A(-BS)	PURY-P300YNNW-A(-BS)	PURY-P300YNNW-A(-BS)
Outdoor unit 2	PURY-P200YNNW-A(-BS)	PURY-P250YNNW-A(-BS)	PURY-P300YNNW-A(-BS)	PURY-P300YNNW-A(-BS)	PURY-P300YNNW-A(-BS)
Outdoor Twinning Kit(optional parts)	CMY-R100VBK4				
BC controller	ø22.2 (ø28.58)*				
~ Twinning pipe	ø22.2				
High pressure a	ø28.58				
Low pressure b	ø22.2 (ø28.58)*				

* When the piping length is 65m or longer, use the ø28.58 pipe for the part that exceeds 65m.

Note 1. Connect the pipes as shown in the figure above. Refer to the table above for the pipe size.

Note 2. Twinning pipes should not be tilted more than 15 degrees from the horizontal plane.

Note 3. Be sure to see the Installation Manual for details of Twinning pipe installation.

Note 4. The pipe section before the Twinning pipe (section "a" and "b" in the figure) must have at least 500mm of straight section (*including the straight pipe that is supplied with the Twinning pipe).

Note 5. Only use the Twinning pipe by Mitsubishi (optional parts).

Note 6. The detachable leg can be removed at site.

PURY-P-Y(S)NW-A

PURY-P650YSNW-A(-BS)

Unit: mm

PURY-P-Y(S)NW-A

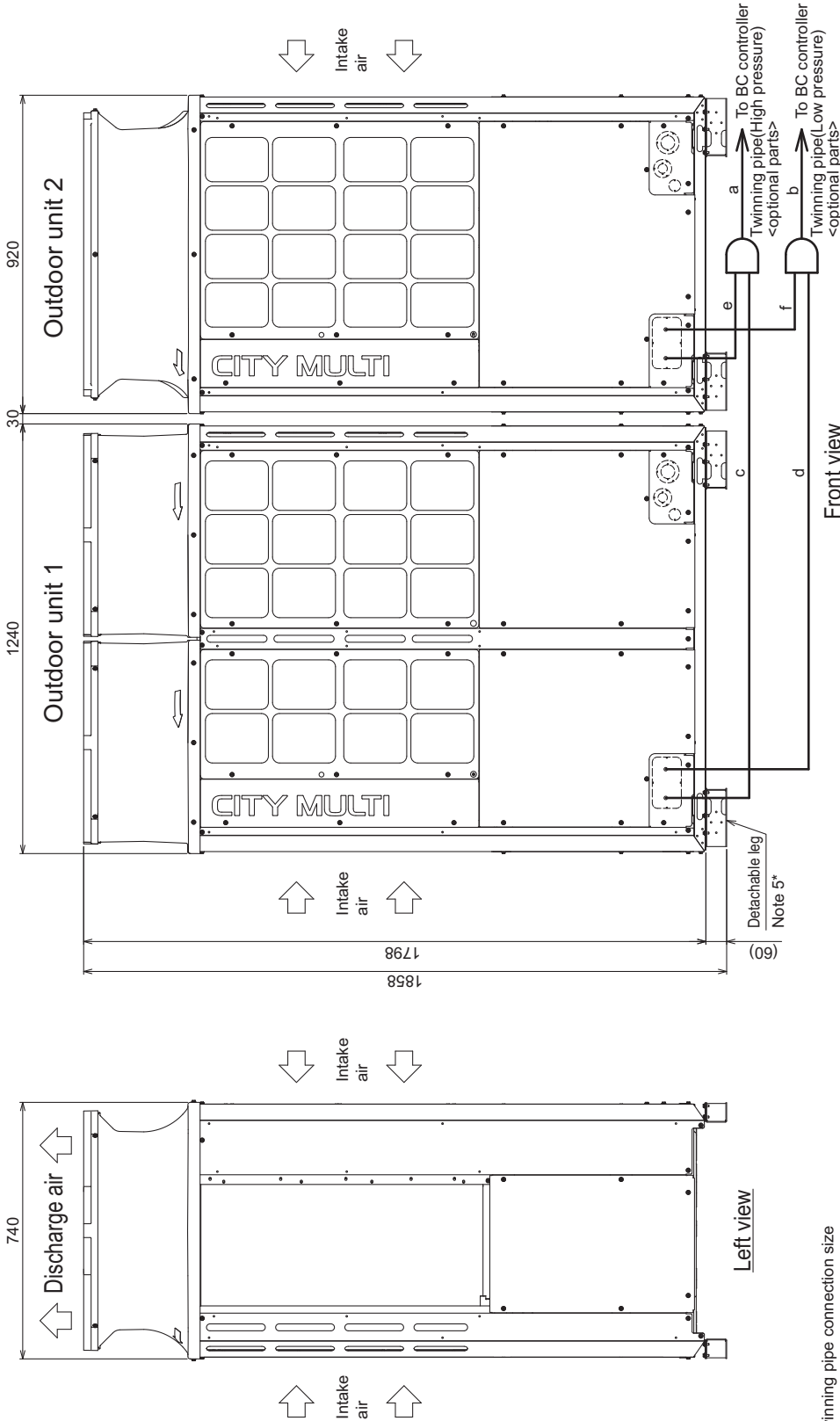

Twinning pipe connection size

Package unit name	PURY-P650YSNW-A(-BS)
Component unit name	Outdoor unit 1 PURY-P350YNW-A(-BS) Outdoor unit 2 PURY-P300YNW-A(-BS)
Outdoor Twinning Kit(optional parts)	CMY-R100VBK4
BC controller	High pressure a Low pressure b
~Twinning pipe	High pressure a Low pressure b
	ø28.58 ø28.58

Unit model	High pressure c or e	Low pressure d or f
Twinning pipe-Outdoor unit	P300 ø19.05	P350 ø22.2 ø28.58

Note 1. Connect the pipes as shown in the figure above. Refer to the table above for the pipe size.

Note 2. Twinning pipes should not be tilted more than 15 degrees from the horizontal plane.

Note 3. Be sure to see the Installation Manual for details of Twinning pipe installation.

Note 4. The pipe section before the Twinning pipe (section "a" and "b" in the figure) must have at least 500mm of straight section (*including the straight pipe that is supplied with the Twinning pipe).

Note 5. Only use the Twinning pipe by Mitsubishi (optional parts).

Note 6. The detachable leg can be removed at site.

PURY-P950YSNW-A(-BS)

Unit: mm

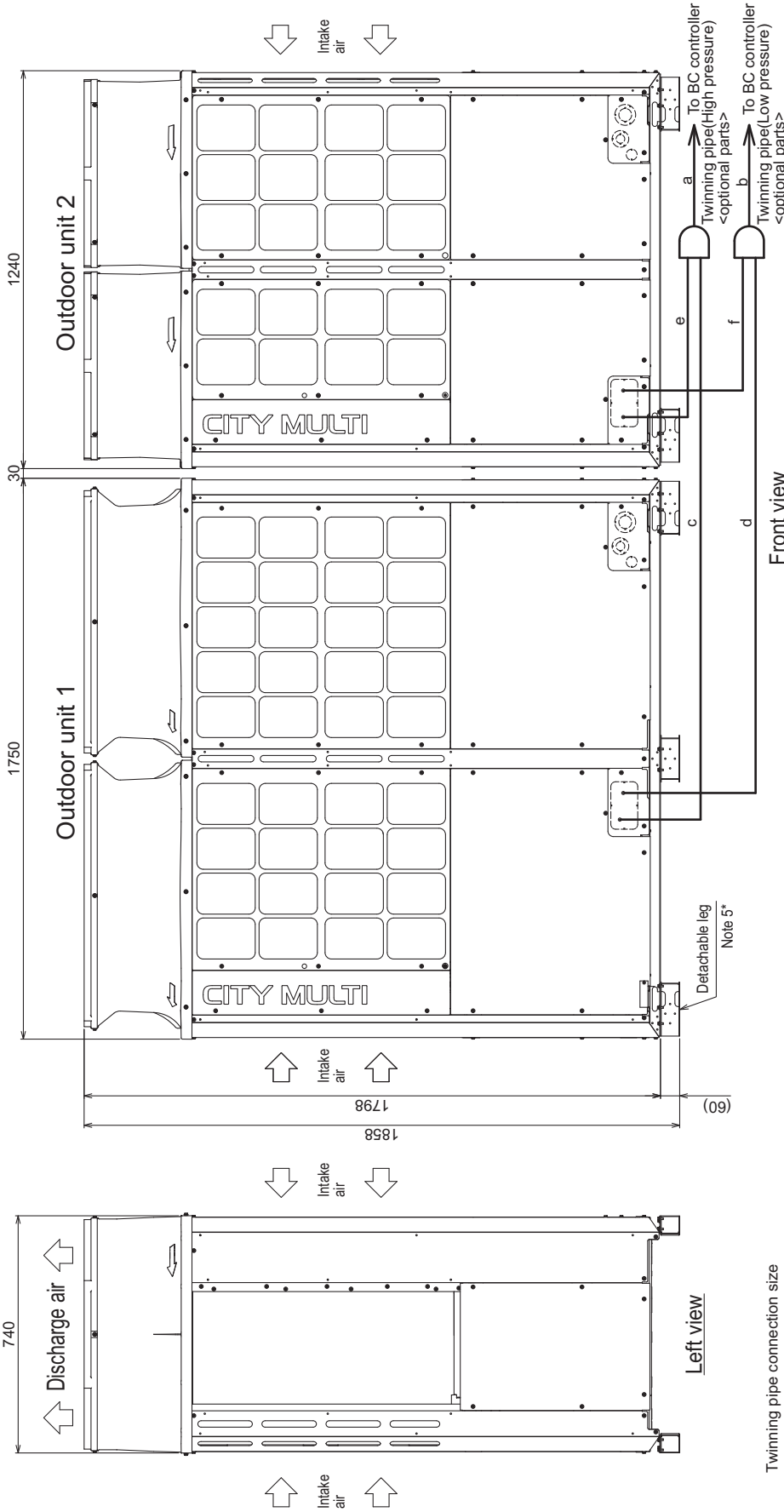

Twinning pipe connection size

Package unit name	PURY-P950YSNW-A(-BS)
Component unit name	Outdoor unit 1 Outdoor unit 2
Outdoor Twinning Kit(optional parts)	CMY-R200VBK4
BC controller	High pressure a Low pressure b
	ø28.58 ø41.28

Unit model	High pressure c or e	Low pressure d or f
Twinning pipe~Outdoor unit	P450 ø22.2	P500 ø28.58
	ø22.2	ø28.58

- Note 1. Connect the pipes as shown in the figure above. Refer to the table above for the pipe size.
 2. Twinning pipes should not be tilted more than 15 degrees from the horizontal plane.
 Be sure to see the Installation Manual for details of Twinning pipe installation.
 3. The pipe section before the Twinning pipe (section "a" and "b" in the figure) must have at least 500mm of straight section (*including the straight pipe that is supplied with the Twinning pipe).
 4. Only use the Twinning pipe by Mitsubishi (optional parts).
 5. The detachable leg can be removed at site.

2. EXTERNAL DIMENSIONS

Outdoor units

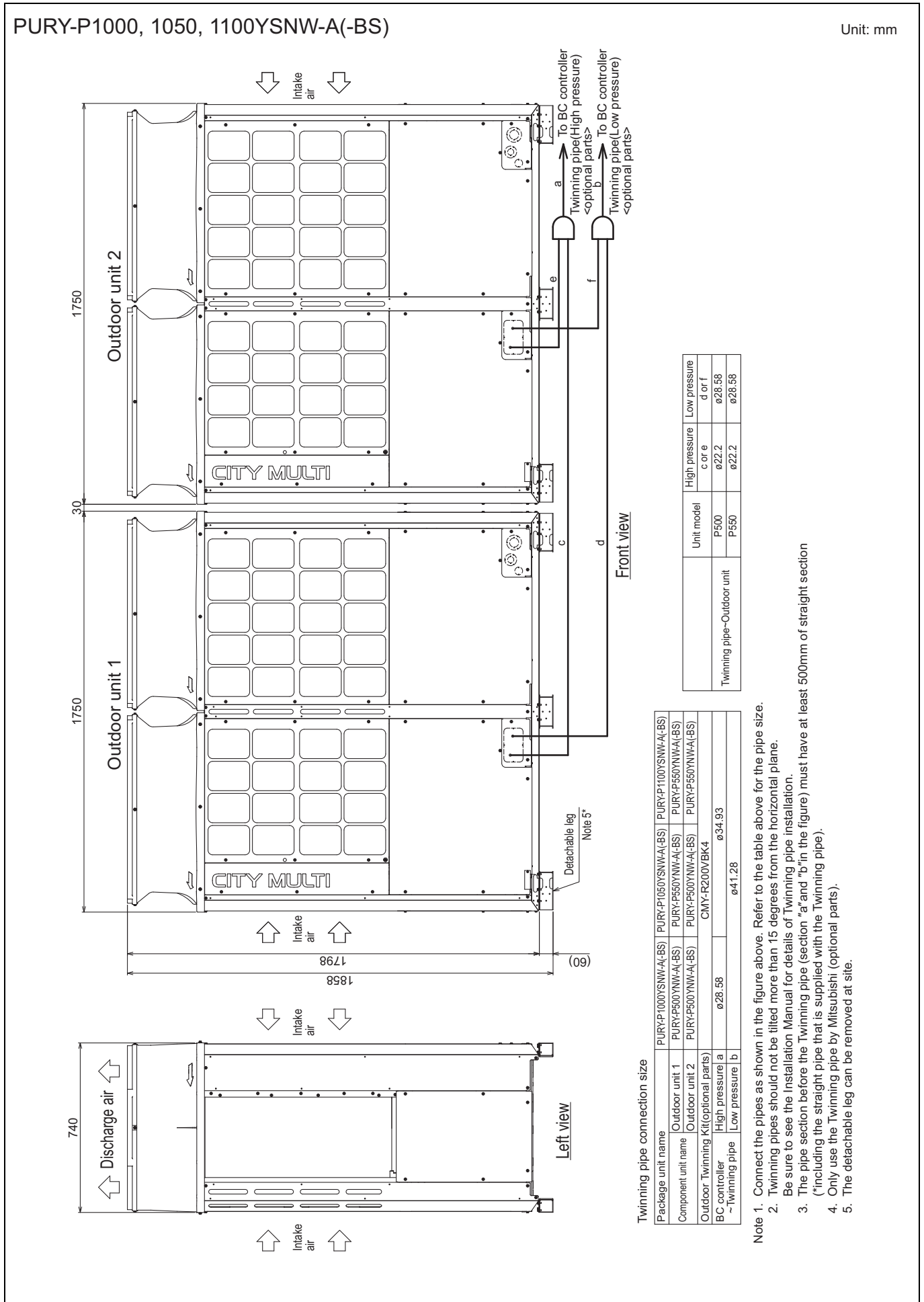

3. CENTER OF GRAVITY

Outdoor units

PURY-P200, 250, 300YNW-A (-BS)

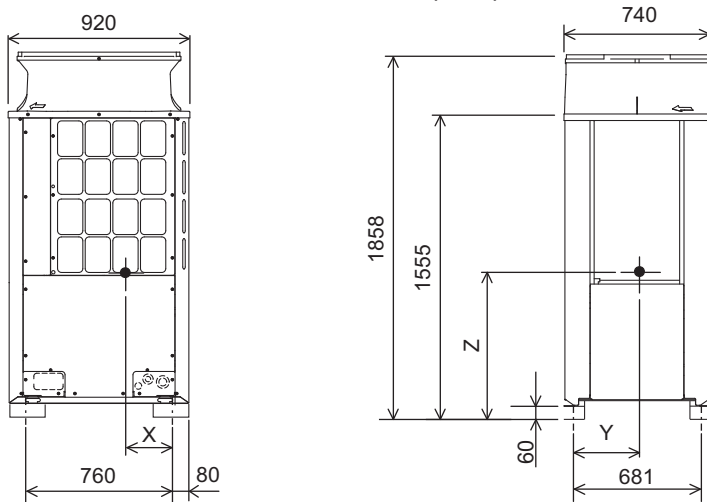

Unit: mm

Model	X	Y	Z
PURY-P200YNW-A(-BS)	356	338	668
PURY-P250YNW-A(-BS)	356	338	668
PURY-P300YNW-A(-BS)	357	338	665

PURY-P350, 400, 450YNW-A (-BS)

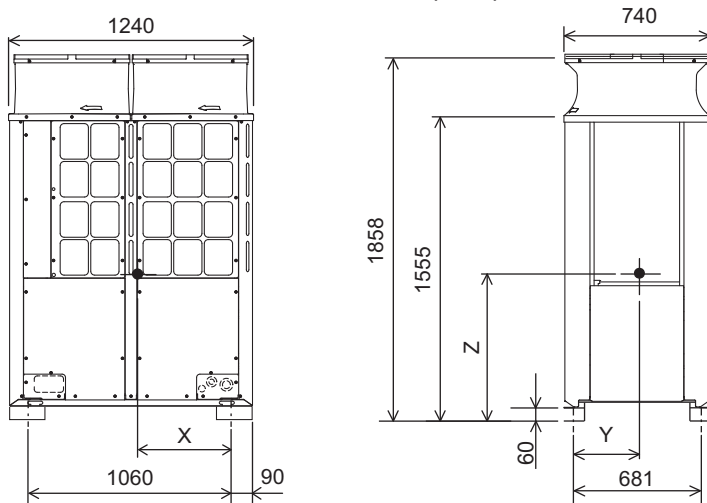

Unit: mm

Model	X	Y	Z
PURY-P350YNW-A(-BS)	502	344	714
PURY-P400YNW-A(-BS)	502	344	714
PURY-P450YNW-A(-BS)	501	345	741

PURY-P500, 550YNW-A (-BS)

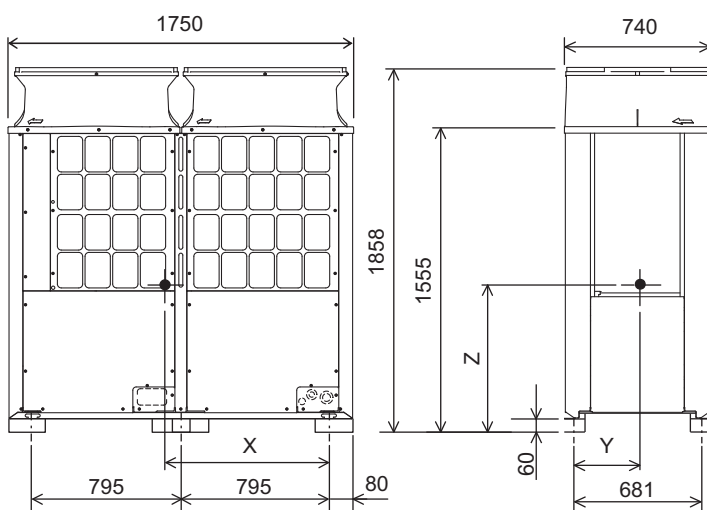

Unit: mm

Model	X	Y	Z
PURY-P500YNW-A(-BS)	871	305	720
PURY-P550YNW-A(-BS)	871	305	720

PURY-P-Y(S)NW-A

PURY-P200, 250, 300YNW-A(-BS)

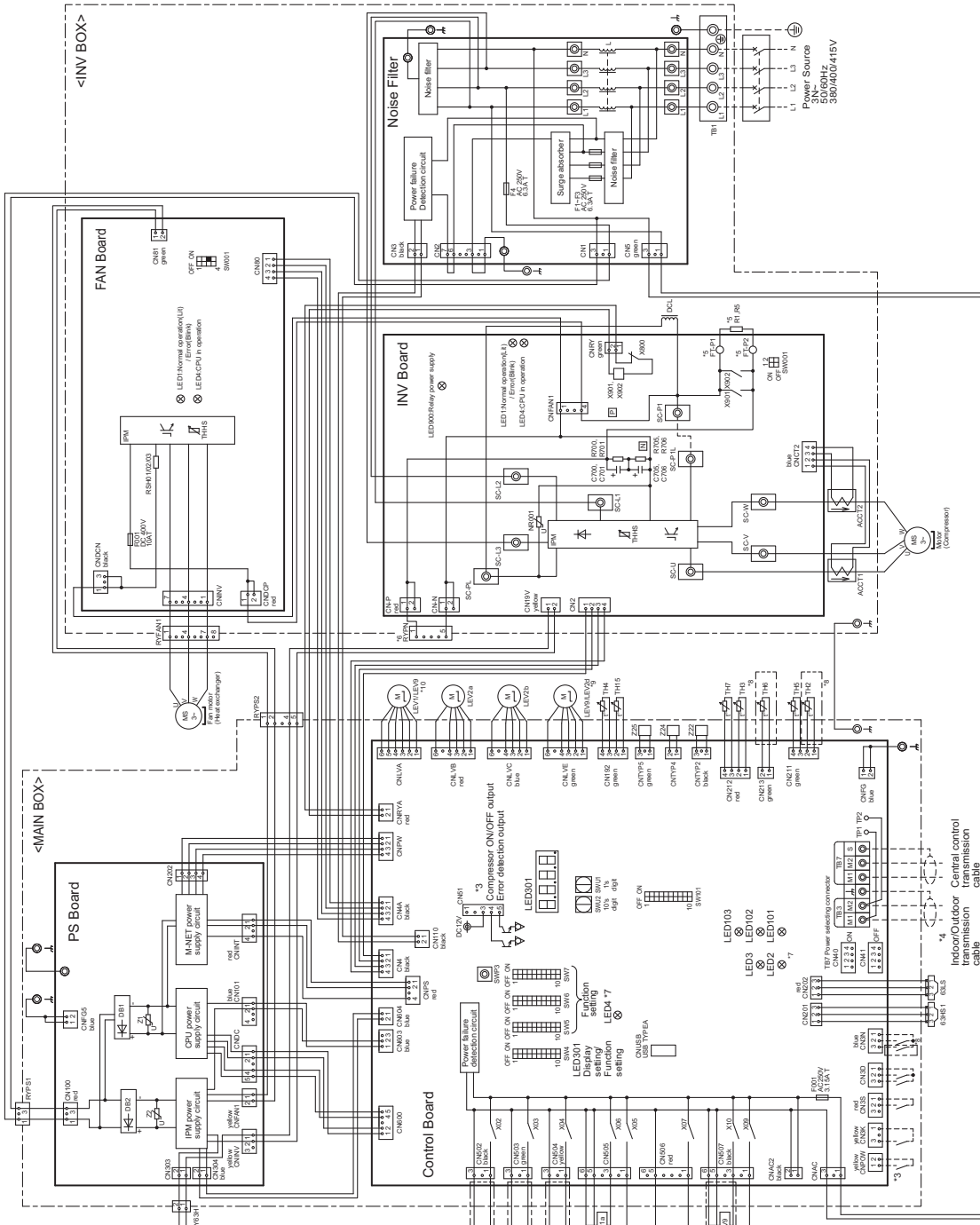

- *1. Single-dotted lines indicate wiring not supplied with the unit.
- *2. Dot-dash lines indicate the control box boundaries.
- *3. Refer to the Data book for connecting input/output signal connectors.
- *4. Daisy-chain terminals (TB3) on the outdoor units in the same refrigerant system together.
- *5. Fasion terminals have a locking function. Make sure the terminals are securely locked in place after insertion. Press the tab on the terminals to removed them.
- *6. Control box houses high-voltage parts. Before inspecting the inside of the MAIN BOX or INV BOX, turn off the power/keep the unit off for at least 10 minutes, and confirm that the voltage of the connector RYPN on INV BOX has dropped to DC20V or less.
- *7. Control board LED display.

LED3	Normal operation(LED/blink)
SW6-10	ON
SW6-10	OFF
SW4	Function setting by SW4 enable(La)/disable(Units)
LED4	USB connection With(La)/Without(Units)
LED01	Normal operation(LED/blink)
LED02	Normal operation(LED/blink)
LED03	Normal operation(LED/blink)

***8. Difference of appliance.**

Model name	Appliance
PURY	-8 do not exist

***9. Difference of appliance.**

Model name	Appliance
PURY	LEV9
PURY	LEV9

***10. Difference of appliance.**

Model name	Appliance
PURY	LEV9
PURY	LEV9

***11. Difference of appliance.**

Model name	Appliance
PURY-P	*11 do not exist
PURY-EP	*11 exist

<Symbol explanation>

Symbol	Explanation
Z154a	4-way valve
Z154b	Heat exchanger capacity control(only)
E3H1	Heat exchanger switching
E3H1	Pressure switch
E3H1	High pressure protection for the outdoor unit
E3S1	Pressure sensor
E3S1	Discharge pressure
C7M-C7E1	Current sensor(AC)
C7M-C7E1	Capacitor(inverter main circuit)
DCL	DC reactor
L	Choke coil (for high frequency noise reduction)
LEV1-10	Hi-C bypass Controls refrigerant flow(Hi-C bypass)
LEV2a-b	Linear sensor valve
LEV2a-9	Pressure control/Refrigerant flow rate control
LEV9-9,10	Heat exchanger for inverter
R15	For mesh current prevention
RS401/2023	For current detection
SV/a	Solenoid valve
SV/2	For opening/closing the bypass suction bypass
SV/9-8	For opening/closing the discharge suction bypass
SV/10-8	For continuous heating
SV/14,15-11	For changing refrigerant flow (cooling/heating)
TB1	Terminal block
TB2	Outdoor/Outdoor transmission cable connection terminal block
TB3	Subcool bypass outlet temperature
TB4	Pipe temperature
TB5	Discharge pipe temperature
TB6	ACC inlet pipe temperature
TB7	Subcooled liquid refrigerant temperature
TB8	OA temperature
TB9	Compressor shell bottom temperature
TB10	Pipe temperature

X301, X302 Magnetic relay (inverter main circuit)
Z21, Z24, Z25 Fan speed setting connector

PURY-P-Y(S)N/A

PURY-P350, 400, 450YNW-A(-BS)

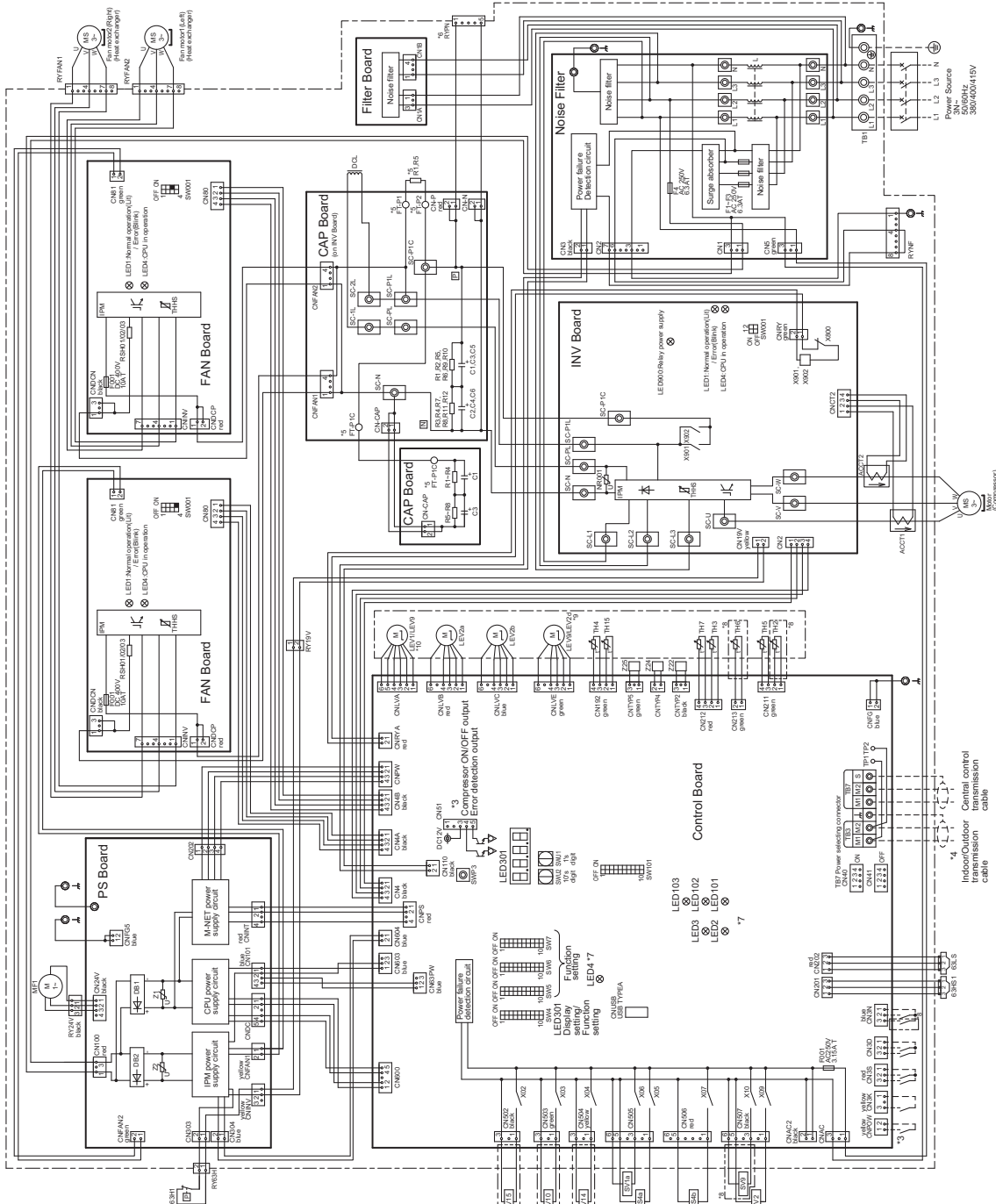

- *1. Single-dotted lines indicate wiring not supplied with the unit.
- *2. Dot-dash lines indicate the control box boundaries.
- *3. Refer to the Data book for connecting input/output signal connectors.
- *4. Daisy-chain terminals (TB3) on the outdoor units in the same refrigerant system together.
- *5. Faston terminals have a locking function. Make sure the terminals are securely locked in place after insertion. Press the tab on the terminals to removed them.
- *6. Control box houses high-voltage parts. Before inspecting the inside of the control box, turn off the power, keep the unit off for at least 10 minutes, and confirm that the voltage of the connector RYPN has dropped to DC20V or less.
- *7. Control board LED display.

LED2	Normal operation(L)/Error(Blank)
LED3	Normal operation(L)/Error(Blank) in operation(L)/in stop(White)
LED4	Normal operation(L)/Error(Blank) in operation(L)/in stop(White)
LED5	Normal operation(L)/Error(Blank) in operation(L)/in stop(White)
LED6	Normal operation(L)/Error(Blank) in operation(L)/in stop(White)
LED7	Normal operation(L)/Error(Blank) in operation(L)/in stop(White)
LED8	Normal operation(L)/Error(Blank) in operation(L)/in stop(White)
LED9	Normal operation(L)/Error(Blank) in operation(L)/in stop(White)
LED10	Normal operation(L)/Error(Blank) in operation(L)/in stop(White)

<Symbol explanation>

Symbol	Explanation
215Aa	Cooling/heating switching
215Ab	Heat exchanger capacity control(only PUHY model)
63H1	Cooling/heating switching
63H2	Cooling/heating switching
63H3	Cooling/heating switching
63S1	Pressure switch
63S2	Pressure switch
63S3	Pressure switch
ACCT1, ACCT2	Current sensor(AC)
CI-C8	Capacitor (inverter main circuit)
DCR	DC reactor
L	Check coil (for high frequency noise reduction)
LEV1 *10	Linear expansion valve
LEV2a,b	Pressure control (Refrigerant flow rate control)
LEV2d *9	Pressure control (Refrigerant flow rate control)
LEV3 *9,10	Heat exchanger for inverter
MF1	Fan motor(for cooling in control box)
R15	Resistor
RSH01/02/03	Resistor
SV1a	Solenoid valve
SV2	Solenoid valve
SV3 *9	Solenoid valve
SV1/2 *8	Solenoid valve
SV1/4,1/5 *11	Solenoid valve
TB1	Terminal block
TB3	Terminal block
TB7	Terminal block
TB2 *8	Terminal block
TB4 *8	Terminal block
TB5	Terminal block
TB6 *8	Terminal block
TB7	Terminal block
TB8	Terminal block
X001, X002	Compressor start/bottom temperature sensor
Z22, Z24, Z25	Function setting connector

- *8. Difference of appliance.
- *9. Difference of appliance.
- *10. Difference of appliance.
- *11. Difference of appliance.

Model name	Appliance
PURY	Appliance
PURY	LEV1
PURY	LEV9

Model name	Appliance
PURY	Appliance
PURY	LEV9
PURY	LEV11 do not exist
PURY	LEV2d

PURY-P500, 550YNW-A(-BS)

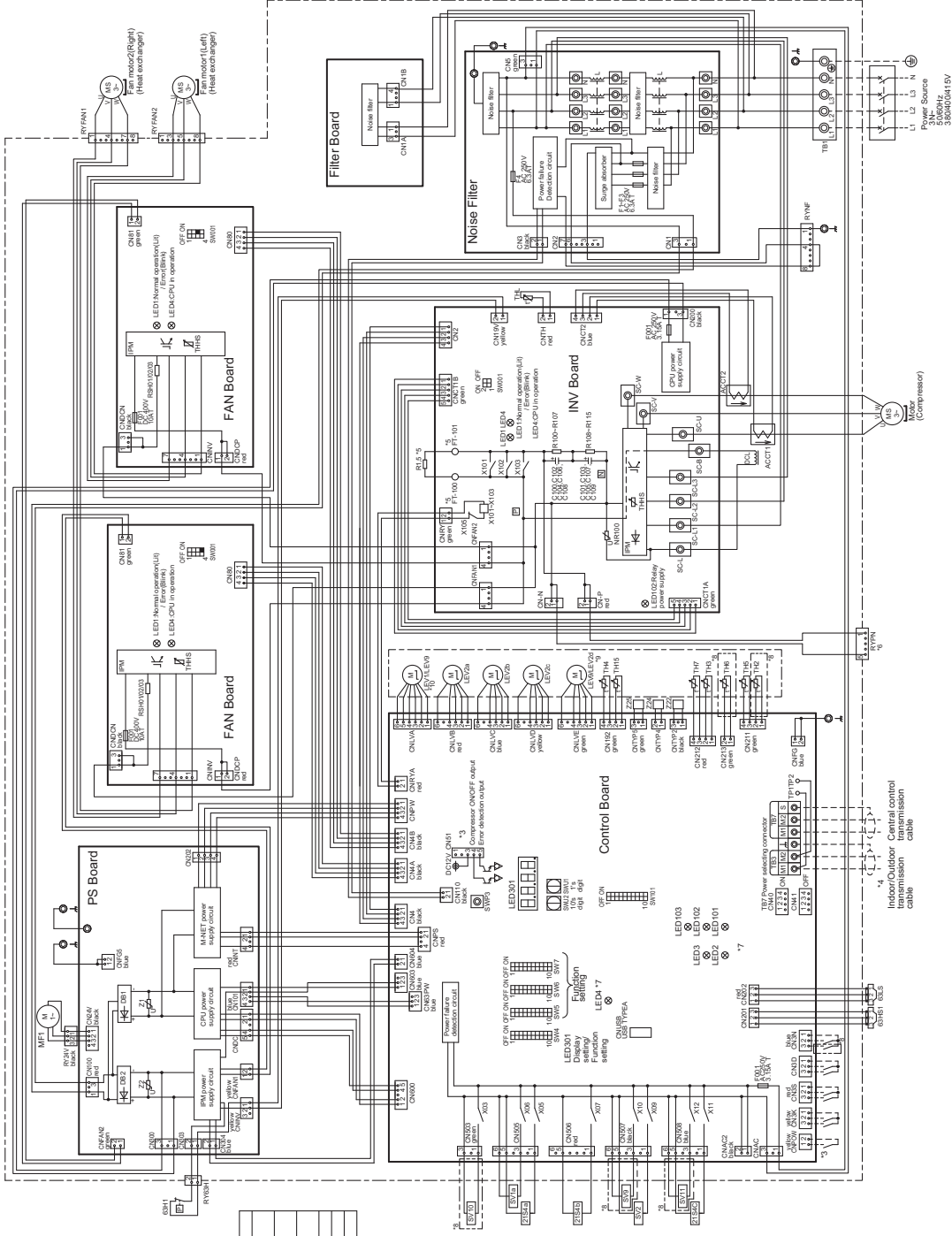

- *1. Single-dotted lines indicate wiring not supplied with the unit.
- *2. Dot-dash lines indicate the control box boundaries.
- *3. Refer to the Data book for connecting input/output signal connectors.
- *4. Daisy-chain terminals (TB3) on the outdoor units in the same refrigerant system together.
- *5. Faston terminals have a locking function. Make sure the terminals are securely locked in place after insertion. Press the tab on the terminals to removed them.
- *6. Control box houses high-voltage parts. Before inspecting the inside of the control box, turn off the power, keep the unit off for at least 10 minutes, and confirm that the voltage of the connector RYPN has dropped to DC20V or less.
- *7. Control board LED display.

LED1	Normal operation (L)/C Error (Unit)
LED2	Normal operation (L)/M/ Error (Blk), for indoor/outdoor transmission
LED3	SW4-10 is OFF and (1) in operation, (L) in stop (Unit)
LED4	SW4-11-10 are OFF
LED5	SW6-10 is ON
LED6	SW6-11 is ON
LED7	SW6-12 is ON
LED8	SW6-13 is ON
LED9	SW6-14 is ON
LED10	SW6-15 is ON
LED11	SW6-16 is ON
LED12	SW6-17 is ON
LED13	SW6-18 is ON
LED14	SW6-19 is ON
LED15	SW6-20 is ON
LED16	SW6-21 is ON
LED17	SW6-22 is ON
LED18	SW6-23 is ON
LED19	SW6-24 is ON
LED20	SW6-25 is ON
LED21	SW6-26 is ON
LED22	SW6-27 is ON
LED23	SW6-28 is ON
LED24	SW6-29 is ON
LED25	SW6-30 is ON

Model name	Appliance
PURY	'9 exist
PURY	'9 do not exist
Model name	Appliance
PURY	LEV9
PURY	LEV9S
PURY	LEV9B
PURY	LEV9C
PURY	LEV9D
PURY	LEV9E
PURY	LEV9F
PURY	LEV9G
PURY	LEV9H
PURY	LEV9I
PURY	LEV9J
PURY	LEV9K
PURY	LEV9L
PURY	LEV9M
PURY	LEV9N
PURY	LEV9O
PURY	LEV9P
PURY	LEV9Q
PURY	LEV9R
PURY	LEV9S
PURY	LEV9T
PURY	LEV9U
PURY	LEV9V
PURY	LEV9W
PURY	LEV9X
PURY	LEV9Y
PURY	LEV9Z

Symbol	Explanation
2/1S4	4-way valve
2/1S4bc	Compressor capacity control (only PURY mode)
63H1	High pressure protection for the PURY mode
63H51	High pressure protection for the PURY mode
63L S	Discharge pressure sensor
ACC1, ACC2	Current sensor (AC)
C100-C109	Capacitor (inverter main circuit)
DCL	Choke coil (for high frequency noise reduction)
LEV1 *10	Linear expansion valve
LEV2a bc	Pressure control/Refrigerant flow rate control
LEV2d *9	Pressure control/Refrigerant flow rate control
LEV9 *9, 10	Heat exchanger for reverter
R15	Resistor
RSH01/02/03	For inrush current prevention
SV1a	For opening/closing the bypass circuit under the O/S
SV2	For opening/closing the discharge suction bypass
SV9 *9	For opening/closing the bypass circuit
SV10, 11 *8	For continuous heating
TB3	Terminal block
TB7	Central control transmission cable
TH2 *8	Central control transmission cable
TH3	Subcool bypass outlet temperature
TH4	Pipe temperature
TH5	Discharge pipe temperature
TH6 *9	ACC inlet pipe temperature
TH7	Subcooled liquid refrigerant temperature
TH8	OA temperature
TH15	Compressor shell bottom temperature
TH16	IPM temperature
X1	Magnetic relay (over main circuit)
Z22, 24, 25	Function setting connector

PURY-P-Y(S)NWA

5-1. Sound levels in cooling mode

Measurement condition
PURY-P200, 250, 300YNW-A(-BS)

1m
 Measurement location
 1m

Sound level of PURY-P300YNW-A(-BS)

	63	125	250	500	1k	2k	4k	8k	dB(A)	
Standard	50/60Hz	75.5	62.5	62.5	60.0	54.0	49.5	44.5	40.0	61.0
Low noise mode	50/60Hz	54.5	53.0	47.0	46.0	40.0	35.0	33.0	33.5	47.0

When Low noise mode is set, the A/C system's capacity is limited. The system could return to normal operation from Low noise mode automatically in the case that the operation condition is severe.

PURY-P-Y(S)NW-A

Sound level of PURY-P200YNW-A(-BS)

	63	125	250	500	1k	2k	4k	8k	dB(A)	
Standard Cooling	50/60Hz	77.0	61.0	60.5	57.5	51.0	46.5	44.0	41.5	59.0
Low noise mode	50/60Hz	51.0	49.5	43.0	39.5	37.5	29.0	33.0	39.0	44.0

When Low noise mode is set, the A/C system's capacity is limited. The system could return to normal operation from Low noise mode automatically in the case that the operation condition is severe.

Sound level of PURY-P250YNW-A(-BS)

	63	125	250	500	1k	2k	4k	8k	dB(A)	
Standard Cooling	50/60Hz	78.0	62.5	61.5	59.0	52.0	48.5	48.5	43.0	60.5
Low noise mode	50/60Hz	53.0	51.5	41.5	42.0	35.0	31.5	38.0	38.5	45.0

When Low noise mode is set, the A/C system's capacity is limited. The system could return to normal operation from Low noise mode automatically in the case that the operation condition is severe.

♦ Depending on the operation conditions, the unit generates noise caused by valve actuation, refrigerant flow, and pressure changes when operating normally. Please consider to avoid location where quietness is required. For BC controller, it is recommended to be installed in places such as ceilings of corridor, rest rooms and plant rooms.

Measurement condition
PURY-P350, 400, 450YNW-A(-BS)

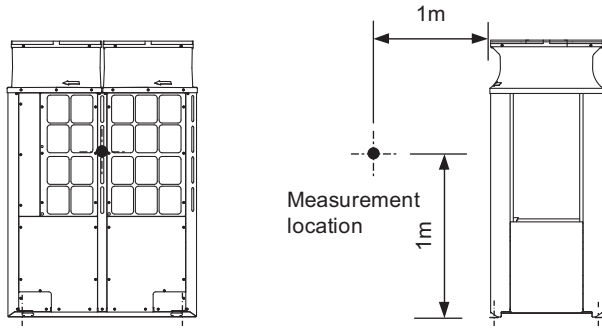

Sound level of PURY-P450YNW-A(-BS)

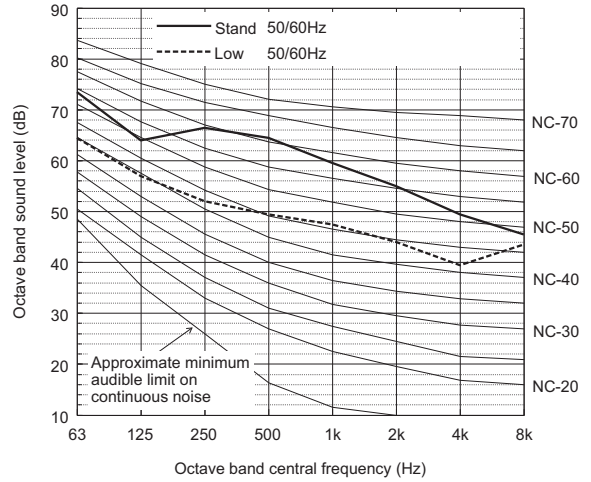

		63	125	250	500	1k	2k	4k	8k	dB(A)
Standard	50/60Hz	73.5	64.0	66.5	64.5	59.5	55.0	49.5	45.5	65.5
Low noise mode	50/60Hz	64.5	57.0	52.0	49.5	47.5	44.0	39.5	43.5	53.0

When Low noise mode is set, the A/C system's capacity is limited. The system could return to normal operation from Low noise mode automatically in the case that the operation condition is severe.

Sound level of PURY-P350YNW-A(-BS)

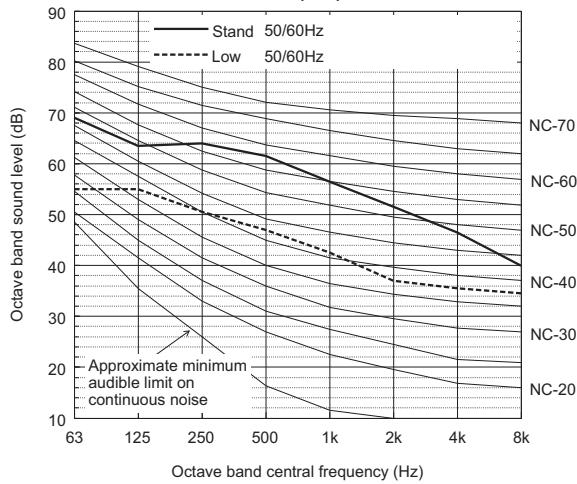

		63	125	250	500	1k	2k	4k	8k	dB(A)
Standard	50/60Hz	69.0	63.5	64.0	61.5	56.5	51.5	46.5	40.0	62.5
Low noise mode	50/60Hz	55.0	55.0	50.5	47.0	42.5	37.0	35.5	34.5	49.0

When Low noise mode is set, the A/C system's capacity is limited. The system could return to normal operation from Low noise mode automatically in the case that the operation condition is severe.

Sound level of PURY-P400YNW-A(-BS)

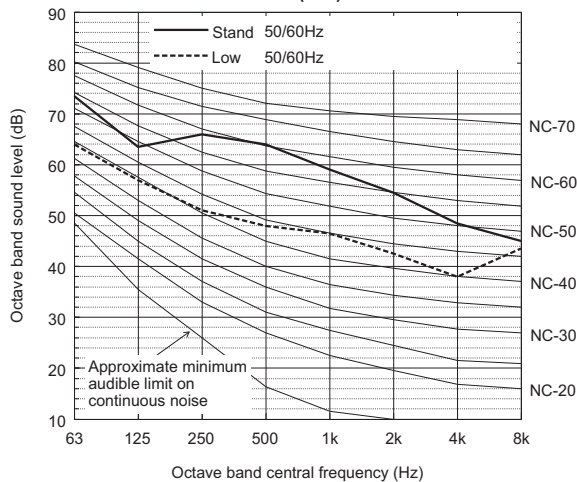

		63	125	250	500	1k	2k	4k	8k	dB(A)
Standard	50/60Hz	73.5	63.5	66.0	64.0	59.0	54.5	48.5	45.0	65.0
Low noise mode	50/60Hz	64.0	57.0	51.0	48.0	46.5	42.5	38.0	43.5	52.0

When Low noise mode is set, the A/C system's capacity is limited. The system could return to normal operation from Low noise mode automatically in the case that the operation condition is severe.

- ◆ Depending on the operation conditions, the unit generates noise caused by valve actuation, refrigerant flow, and pressure changes when operating normally. Please consider to avoid location where quietness is required. For BC controller, it is recommended to be installed in places such as ceilings of corridor, rest rooms and plant rooms.

PURY-P-Y(S)NW-A

Measurement condition
PURY-P500, 550YNW-A(-BS)

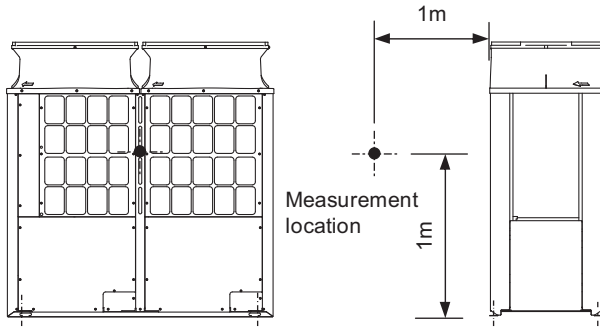

Measurement condition
PURY-P400, 450, 500, 550, 600YSNW-A(-BS)

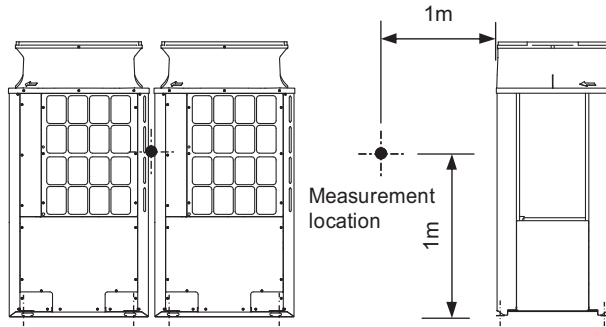

Sound level of PURY-P500YNW-A(-BS)

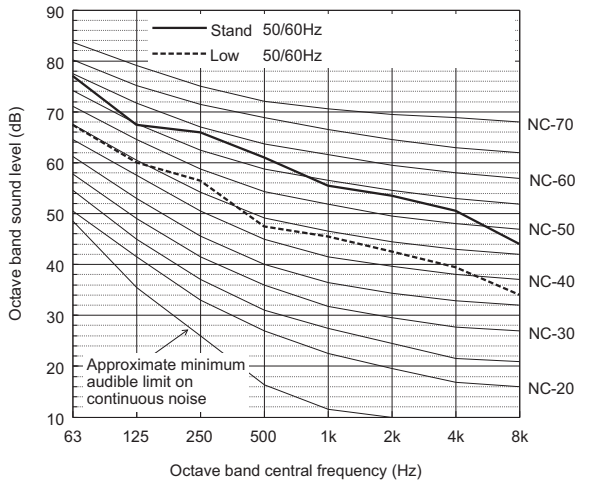

		63	125	250	500	1k	2k	4k	8k	dB(A)
Standard	50/60Hz	77.0	67.5	66.0	61.0	55.5	53.5	50.5	44.0	63.5
Low noise mode	50/60Hz	67.5	60.0	56.5	47.5	45.5	42.5	39.5	34.0	53.0

When Low noise mode is set, the A/C system's capacity is limited. The system could return to normal operation from Low noise mode automatically in the case that the operation condition is severe.

Sound level of PURY-P400YSNW-A(-BS)

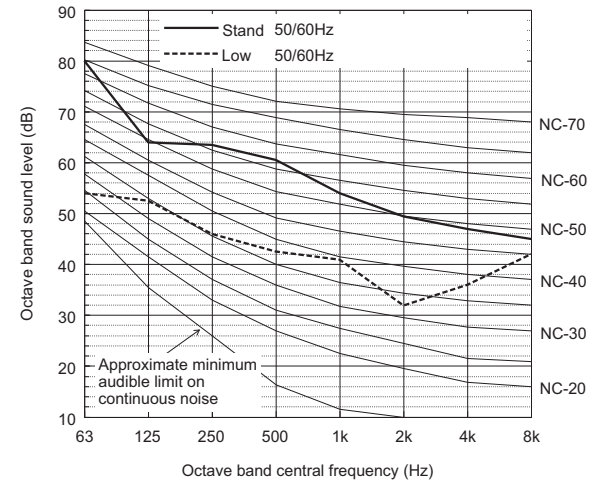

		63	125	250	500	1k	2k	4k	8k	dB(A)
Standard Cooling	50/60Hz	80.0	64.0	63.5	60.5	54.0	49.5	47.0	45.0	62.0
Low noise mode	50/60Hz	54.0	52.5	46.0	42.5	41.0	32.0	36.0	42.0	47.0

When Low noise mode is set, the A/C system's capacity is limited. The system could return to normal operation from Low noise mode automatically in the case that the operation condition is severe.

Sound level of PURY-P550YNW-A(-BS)

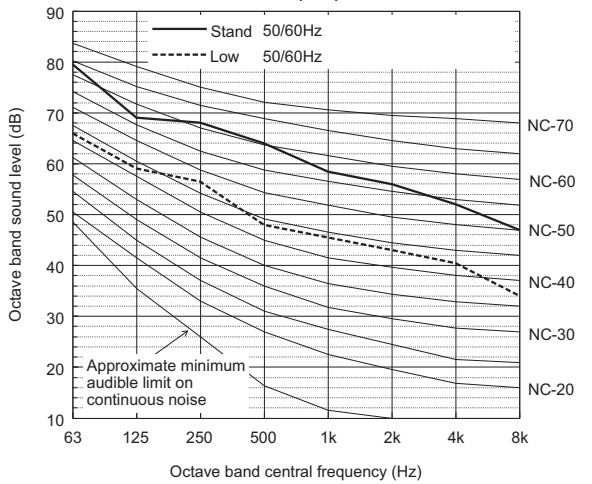

		63	125	250	500	1k	2k	4k	8k	dB(A)
Standard Cooling	50/60Hz	79.5	69.0	68.0	64.0	58.5	56.0	52.0	47.0	66.0
Low noise mode	50/60Hz	66.0	59.0	56.5	48.0	45.5	43.0	40.5	34.0	53.0

When Low noise mode is set, the A/C system's capacity is limited. The system could return to normal operation from Low noise mode automatically in the case that the operation condition is severe.

Sound level of PURY-P450YSNW-A(-BS)

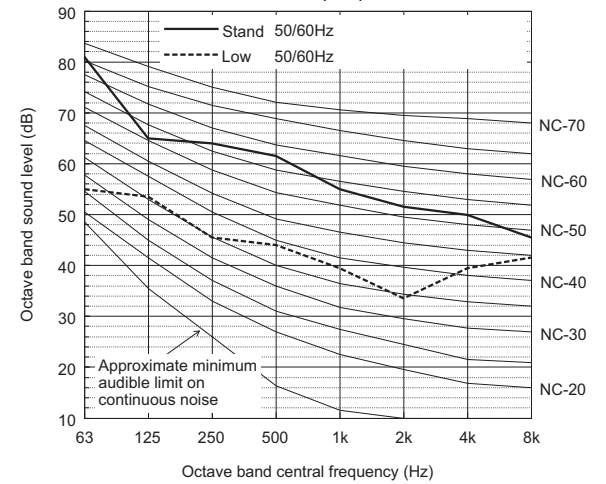

		63	125	250	500	1k	2k	4k	8k	dB(A)
Standard Cooling	50/60Hz	81.0	65.0	64.0	61.5	55.0	51.5	50.0	45.5	63.0
Low noise mode	50/60Hz	55.0	53.5	45.5	44.0	39.5	33.5	39.5	41.5	47.5

When Low noise mode is set, the A/C system's capacity is limited. The system could return to normal operation from Low noise mode automatically in the case that the operation condition is severe.

• Depending on the operation conditions, the unit generates noise caused by valve actuation, refrigerant flow, and pressure changes when operating normally. Please consider to avoid location where quietness is required. For BC controller, it is recommended to be installed in places such as ceilings of corridor, rest rooms and plant rooms.

Sound level of PURY-P500YSNW-A(-BS)

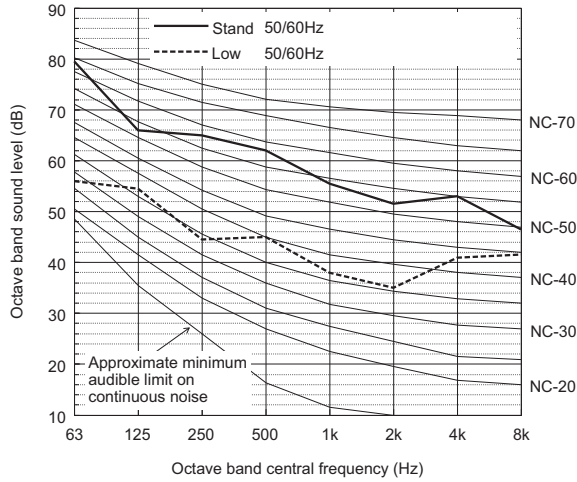

		63	125	250	500	1k	2k	4k	8k	dB(A)
Standard	50/60Hz	79.5	66.0	65.0	62.0	55.5	51.5	53.0	46.5	63.5
Low noise mode	50/60Hz	56.0	54.5	44.5	45.0	38.0	35.0	41.0	41.5	48.0

When Low noise mode is set, the A/C system's capacity is limited. The system could return to normal operation from Low noise mode automatically in the case that the operation condition is severe.

Measurement condition PURY-P650YSNW-A(-BS)

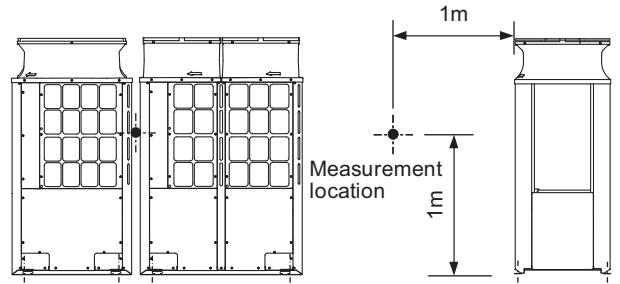

Sound level of PURY-P550YSNW-A(-BS)

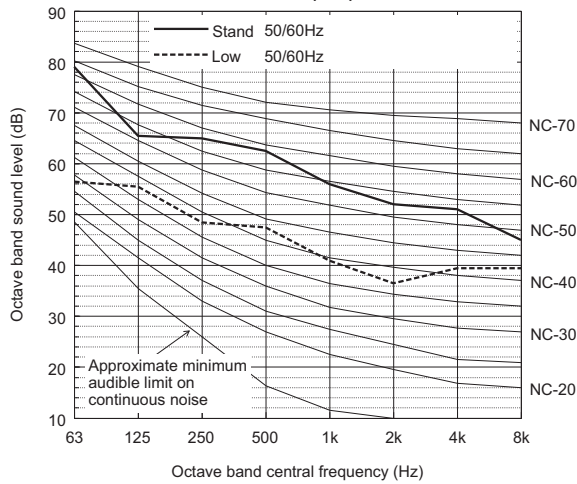

		63	125	250	500	1k	2k	4k	8k	dB(A)
Standard	50/60Hz	79.0	65.5	65.0	62.5	56.0	52.0	51.0	45.0	64.0
Low noise mode	50/60Hz	56.5	55.5	48.5	47.5	41.0	36.5	39.5	39.5	49.5

When Low noise mode is set, the A/C system's capacity is limited. The system could return to normal operation from Low noise mode automatically in the case that the operation condition is severe.

Sound level of PURY-P650YSNW-A(-BS)

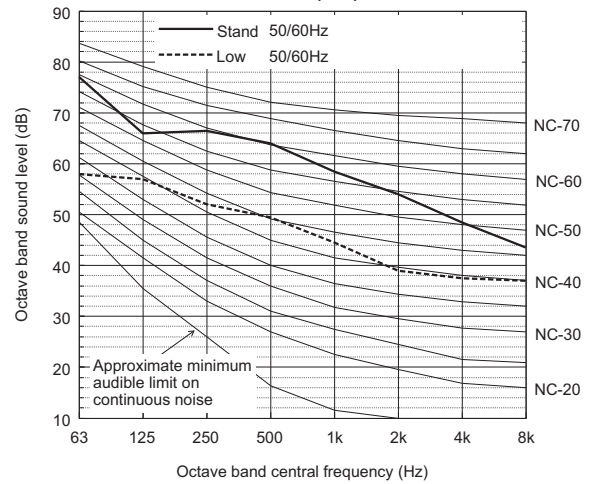

		63	125	250	500	1k	2k	4k	8k	dB(A)
Standard	50/60Hz	77.0	66.0	66.5	64.0	58.5	54.0	48.5	43.5	65.0
Low noise mode	50/60Hz	58.0	57.0	52.0	49.5	44.5	39.0	37.5	37.0	51.5

When Low noise mode is set, the A/C system's capacity is limited. The system could return to normal operation from Low noise mode automatically in the case that the operation condition is severe.

Sound level of PURY-P600YSNW-A(-BS)

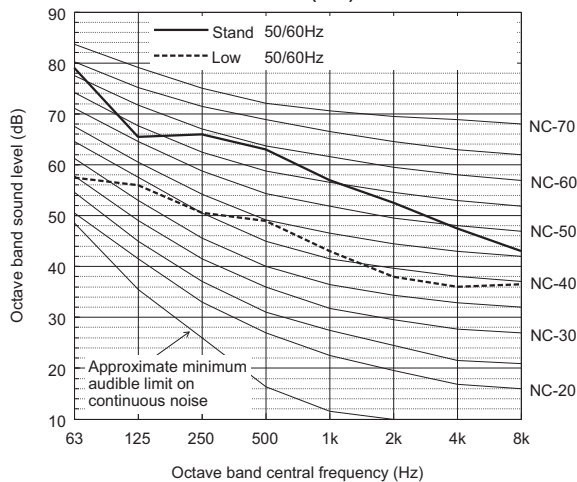

		63	125	250	500	1k	2k	4k	8k	dB(A)
Standard	50/60Hz	79.0	65.5	66.0	63.0	57.0	52.5	47.5	43.0	64.0
Low noise mode	50/60Hz	57.5	56.0	50.5	49.0	43.0	38.0	36.0	36.5	50.0

When Low noise mode is set, the A/C system's capacity is limited. The system could return to normal operation from Low noise mode automatically in the case that the operation condition is severe.

- ◆ Depending on the operation conditions, the unit generates noise caused by valve actuation, refrigerant flow, and pressure changes when operating normally. Please consider to avoid location where quietness is required. For BC controller, it is recommended to be installed in places such as ceilings of corridor, rest rooms and plant rooms.

PURY-P-Y(S)NW-A

Measurement condition
PURY-P700, 750, 800, 850, 900YSNW-A(-BS)

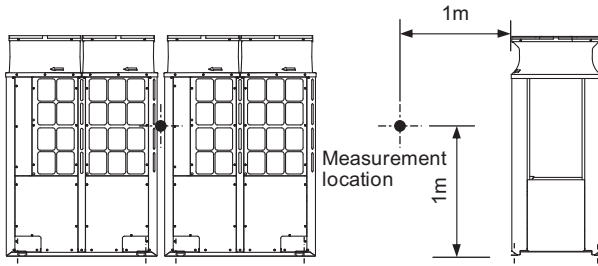

Sound level of PURY-P800YSNW-A(-BS)

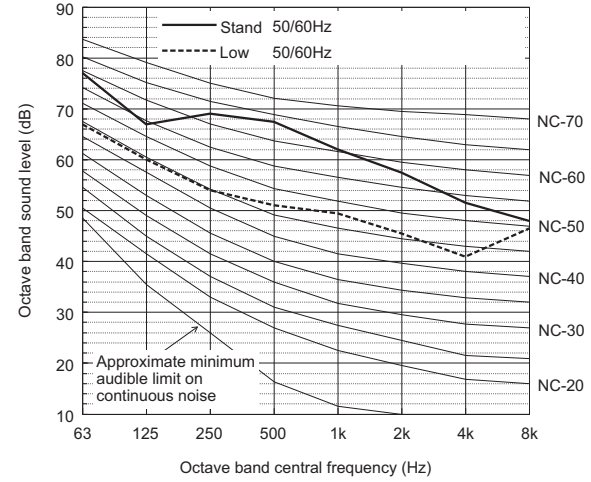

		63	125	250	500	1k	2k	4k	8k	dB(A)
Standard	50/60Hz	77.0	67.0	69.0	67.5	62.0	57.5	51.5	48.0	68.0
Low noise mode	50/60Hz	67.0	60.0	54.0	51.0	49.5	45.5	41.0	46.5	55.0

When Low noise mode is set, the A/C system's capacity is limited. The system could return to normal operation from Low noise mode automatically in the case that the operation condition is severe.

Sound level of PURY-P700YSNW-A(-BS)

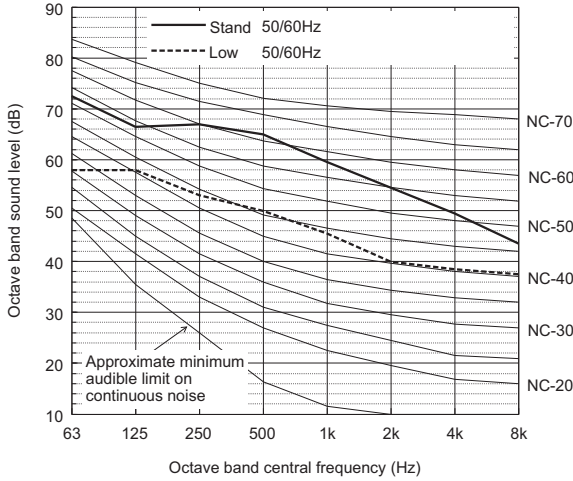

		63	125	250	500	1k	2k	4k	8k	dB(A)
Standard	50/60Hz	72.5	66.5	67.0	65.0	59.5	54.5	49.5	43.5	65.5
Low noise mode	50/60Hz	58.0	58.0	53.0	50.0	45.5	40.0	38.5	37.5	52.0

When Low noise mode is set, the A/C system's capacity is limited. The system could return to normal operation from Low noise mode automatically in the case that the operation condition is severe.

Sound level of PURY-P850YSNW-A(-BS)

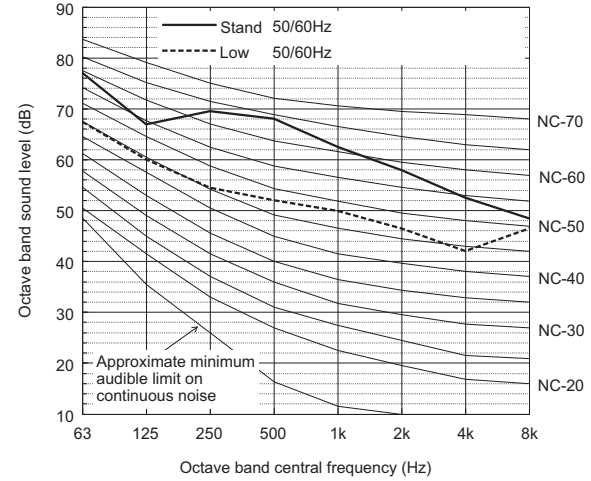

		63	125	250	500	1k	2k	4k	8k	dB(A)
Standard	50/60Hz	77.0	67.0	69.5	68.0	62.5	58.0	52.5	48.5	68.5
Low noise mode	50/60Hz	67.5	60.0	54.5	52.0	50.0	46.5	42.0	46.5	55.5

When Low noise mode is set, the A/C system's capacity is limited. The system could return to normal operation from Low noise mode automatically in the case that the operation condition is severe.

Sound level of PURY-P750YSNW-A(-BS)

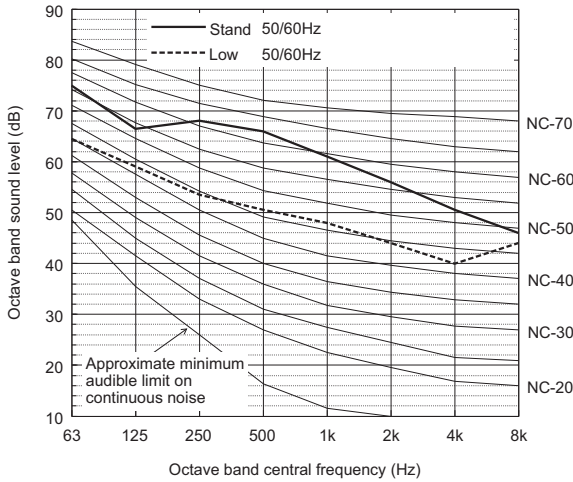

		63	125	250	500	1k	2k	4k	8k	dB(A)
Standard	50/60Hz	75.0	66.5	68.0	66.0	61.0	56.0	50.5	46.0	67.0
Low noise mode	50/60Hz	64.5	59.0	53.5	50.5	48.0	44.0	40.0	44.0	54.0

When Low noise mode is set, the A/C system's capacity is limited. The system could return to normal operation from Low noise mode automatically in the case that the operation condition is severe.

Sound level of PURY-P900YSNW-A(-BS)

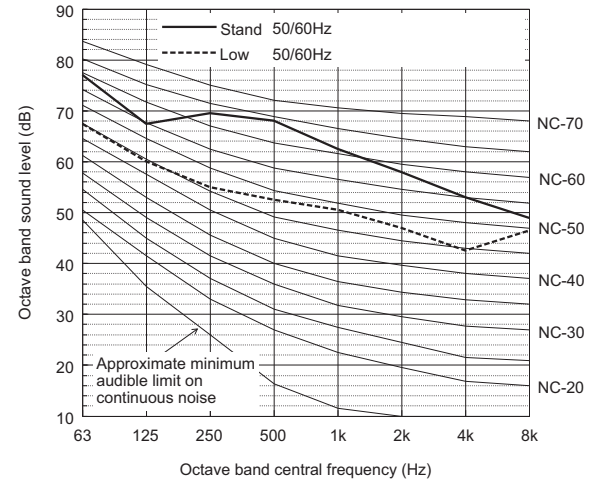

		63	125	250	500	1k	2k	4k	8k	dB(A)
Standard	50/60Hz	77.0	67.5	69.5	68.0	62.5	58.0	53.0	49.0	68.5
Low noise mode	50/60Hz	67.5	60.0	55.0	52.5	50.5	47.0	42.5	46.5	56.0

When Low noise mode is set, the A/C system's capacity is limited. The system could return to normal operation from Low noise mode automatically in the case that the operation condition is severe.

PURY-P-Y(S)NW-A

• Depending on the operation conditions, the unit generates noise caused by valve actuation, refrigerant flow, and pressure changes when operating normally. Please consider to avoid location where quietness is required. For BC controller, it is recommended to be installed in places such as ceilings of corridor, rest rooms and plant rooms.

Measurement condition
PURY-P950YSNW-A(-BS)

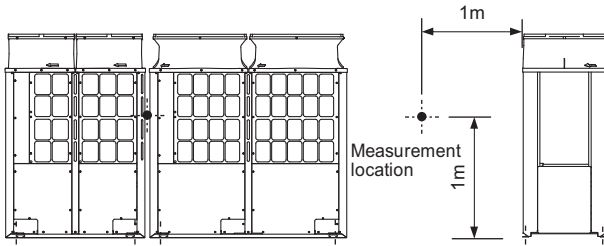

Measurement condition
PURY-P1000, 1050, 1100YSNW-A(-BS)

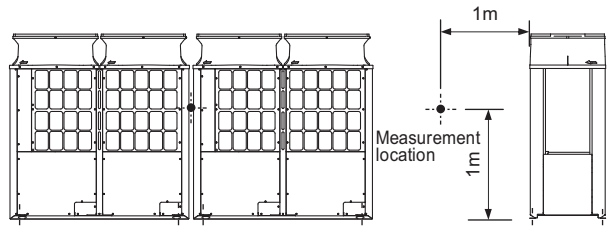

Sound level of PURY-P950YSNW-A(-BS)

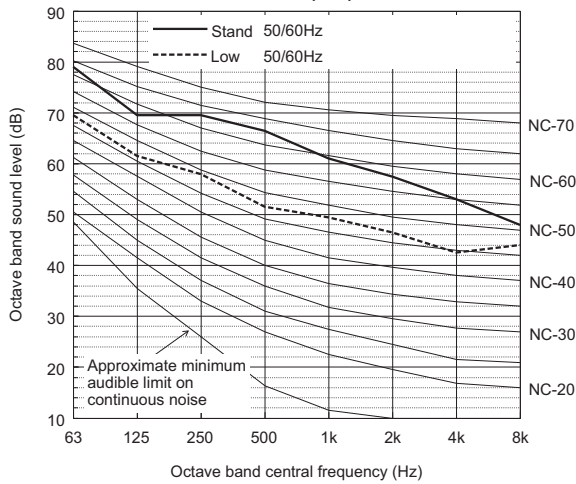

		63	125	250	500	1k	2k	4k	8k	dB(A)
Standard	50/60Hz	79.0	69.5	69.5	66.5	61.0	57.5	53.0	48.0	68.0
Low noise mode	50/60Hz	69.5	61.5	58.0	51.5	49.5	46.5	42.5	44.0	56.0

When Low noise mode is set, the A/C system's capacity is limited. The system could return to normal operation from Low noise mode automatically in the case that the operation condition is severe.

Sound level of PURY-P1000YSNW-A(-BS)

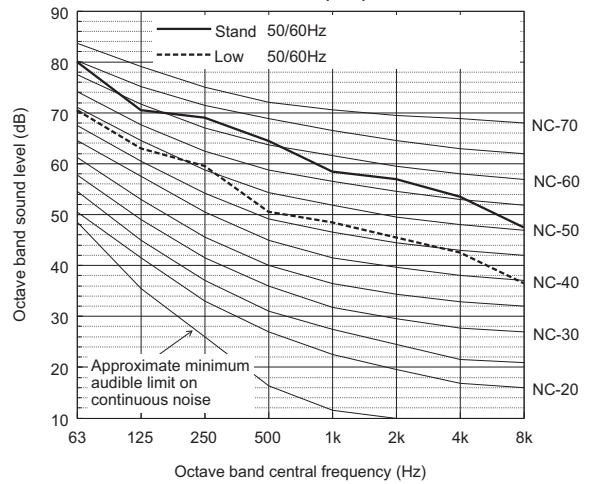

		63	125	250	500	1k	2k	4k	8k	dB(A)
Standard	50/60Hz	80.0	70.5	69.0	64.5	58.5	57.0	53.5	47.5	66.5
Low noise mode	50/60Hz	70.5	63.0	59.5	50.5	48.5	45.5	42.5	36.5	56.0

When Low noise mode is set, the A/C system's capacity is limited. The system could return to normal operation from Low noise mode automatically in the case that the operation condition is severe.

Sound level of PURY-P1050YSNW-A(-BS)

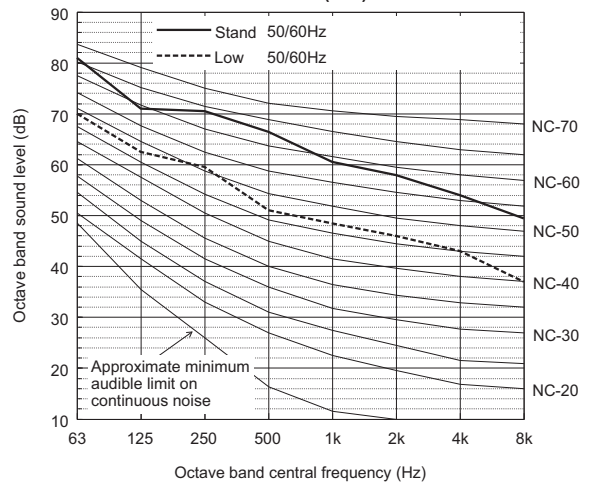

		63	125	250	500	1k	2k	4k	8k	dB(A)
Standard	50/60Hz	81.0	71.0	70.5	66.5	60.5	58.0	54.0	49.5	68.0
Low noise mode	50/60Hz	70.0	62.5	59.5	51.0	48.5	46.0	43.0	37.0	56.0

When Low noise mode is set, the A/C system's capacity is limited. The system could return to normal operation from Low noise mode automatically in the case that the operation condition is severe.

- ◆ Depending on the operation conditions, the unit generates noise caused by valve actuation, refrigerant flow, and pressure changes when operating normally. Please consider to avoid location where quietness is required. For BC controller, it is recommended to be installed in places such as ceilings of corridor, rest rooms and plant rooms.

PURY-P-Y(S)NW-A

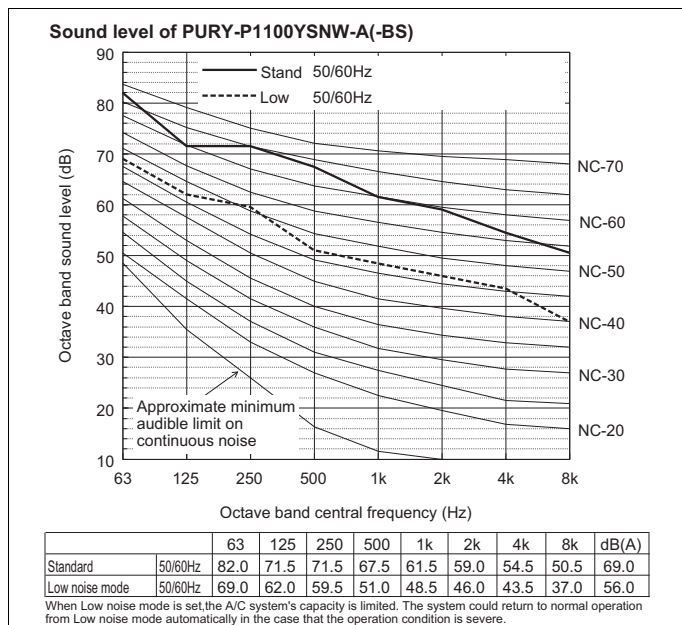

- Depending on the operation conditions, the unit generates noise caused by valve actuation, refrigerant flow, and pressure changes when operating normally. Please consider to avoid location where quietness is required. For BC controller, it is recommended to be installed in places such as ceilings of corridor, rest rooms and plant rooms.

PURY-P-Y(S)NW-A

5-2. Sound levels in heating mode

Measurement condition
 PURY-P200, 250, 300YNW-A(-BS)

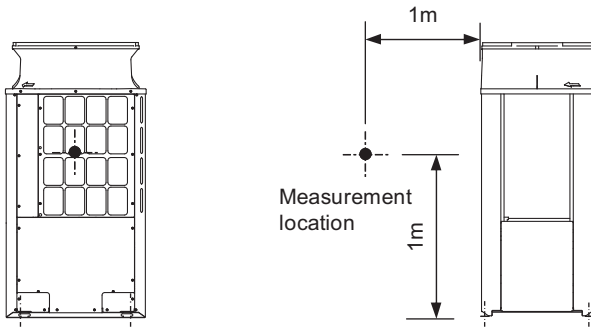

Sound level of PURY-P300YNW-A(-BS)

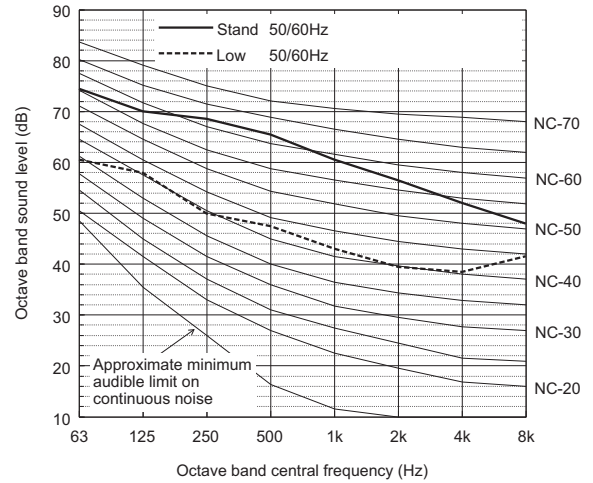

		63	125	250	500	1k	2k	4k	8k	dB(A)
Standard Heating	50/60Hz	74.5	70.0	68.5	65.5	60.5	56.5	52.0	48.0	67.0
Low noise mode	50/60Hz	60.5	58.0	50.0	47.5	43.0	39.5	38.5	41.5	50.5

When Low noise mode is set, the A/C system's capacity is limited. The system could return to normal operation from Low noise mode automatically in the case that the operation condition is severe.

Sound level of PURY-P200YNW-A(-BS)

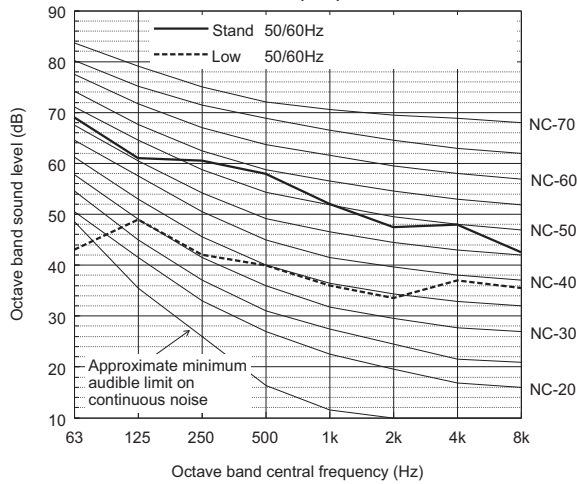

		63	125	250	500	1k	2k	4k	8k	dB(A)
Standard Heating	50/60Hz	69.0	61.0	60.5	58.0	52.0	47.5	48.0	42.5	59.0
Low noise mode	50/60Hz	43.0	49.0	42.0	40.0	36.0	33.5	37.0	35.5	44.0

When Low noise mode is set, the A/C system's capacity is limited. The system could return to normal operation from Low noise mode automatically in the case that the operation condition is severe.

Sound level of PURY-P250YNW-A(-BS)

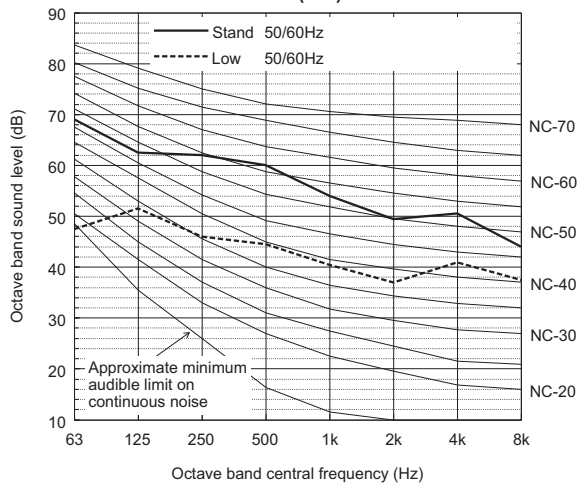

		63	125	250	500	1k	2k	4k	8k	dB(A)
Standard Heating	50/60Hz	69.0	62.5	62.0	60.0	54.0	49.5	50.5	44.0	61.0
Low noise mode	50/60Hz	47.5	51.5	46.0	44.5	40.5	37.0	41.0	37.5	48.0

When Low noise mode is set, the A/C system's capacity is limited. The system could return to normal operation from Low noise mode automatically in the case that the operation condition is severe.

- Depending on the operation conditions, the unit generates noise caused by valve actuation, refrigerant flow, and pressure changes when operating normally. Please consider to avoid location where quietness is required. For BC controller, it is recommended to be installed in places such as ceilings of corridor, rest rooms and plant rooms.

PURY-P-Y(S)NW-A

Measurement condition
PURY-P350, 400, 450YNW-A(-BS)

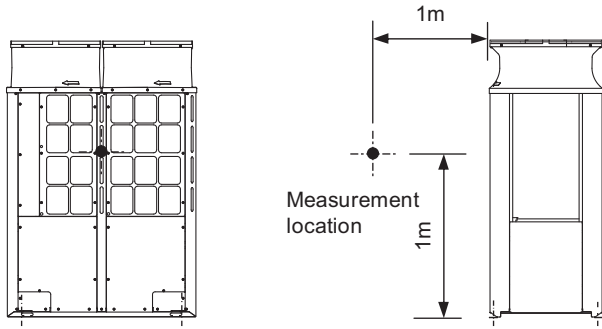

Sound level of PURY-P450YNW-A(-BS)

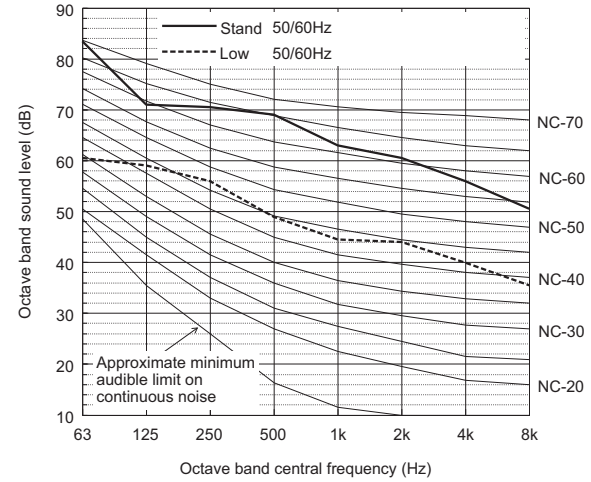

		63	125	250	500	1k	2k	4k	8k	dB(A)
Standard Heating	50/60Hz	83.5	71.0	70.5	69.0	63.0	60.5	56.0	50.5	70.0
Low noise mode	50/60Hz	60.5	59.0	56.0	49.0	44.5	44.0	40.0	35.5	53.0

When Low noise mode is set, the A/C system's capacity is limited. The system could return to normal operation from Low noise mode automatically in the case that the operation condition is severe.

Sound level of PURY-P350YNW-A(-BS)

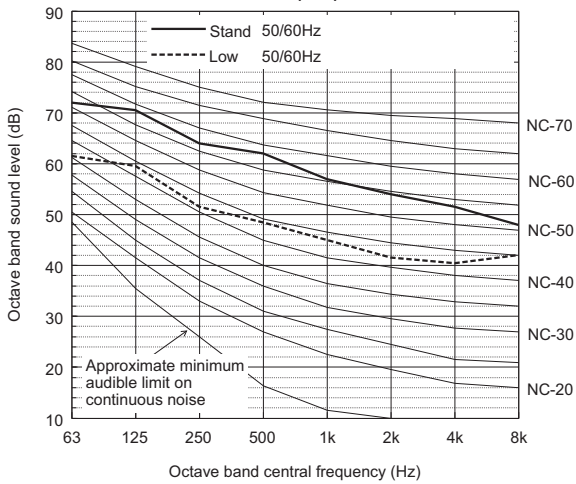

		63	125	250	500	1k	2k	4k	8k	dB(A)
Standard Heating	50/60Hz	72.0	70.5	64.0	62.0	57.0	54.0	51.5	48.0	64.0
Low noise mode	50/60Hz	61.5	59.5	51.5	48.5	45.0	41.5	40.5	42.0	52.0

When Low noise mode is set, the A/C system's capacity is limited. The system could return to normal operation from Low noise mode automatically in the case that the operation condition is severe.

Sound level of PURY-P400YNW-A(-BS)

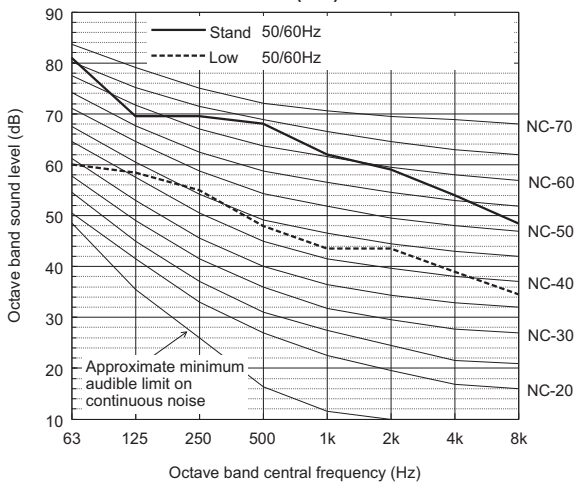

		63	125	250	500	1k	2k	4k	8k	dB(A)
Standard Heating	50/60Hz	81.0	69.5	69.5	68.0	62.0	59.0	54.0	48.5	69.0
Low noise mode	50/60Hz	60.0	58.5	55.0	48.0	43.5	43.5	39.0	34.5	52.0

When Low noise mode is set, the A/C system's capacity is limited. The system could return to normal operation from Low noise mode automatically in the case that the operation condition is severe.

- ♦ Depending on the operation conditions, the unit generates noise caused by valve actuation, refrigerant flow, and pressure changes when operating normally. Please consider to avoid location where quietness is required. For BC controller, it is recommended to be installed in places such as ceilings of corridor, rest rooms and plant rooms.

PURY-P-Y(S)NW-A

Measurement condition
PURY-P500, 550YNW-A(-BS)

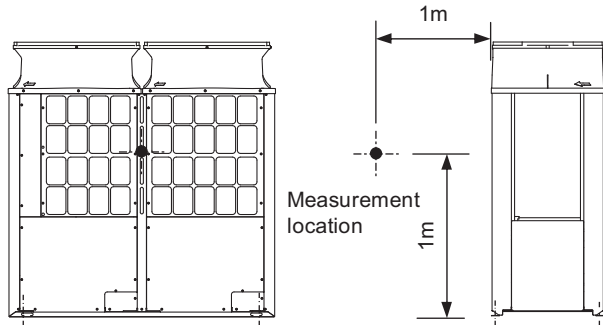

Measurement condition
PURY-P400, 450, 500, 550, 600YSNW-A(-BS)

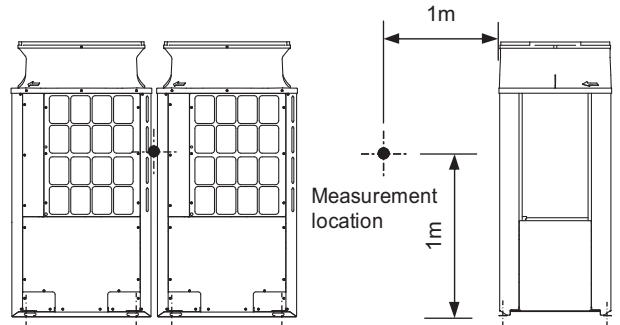

Sound level of PURY-P500YNW-A(-BS)

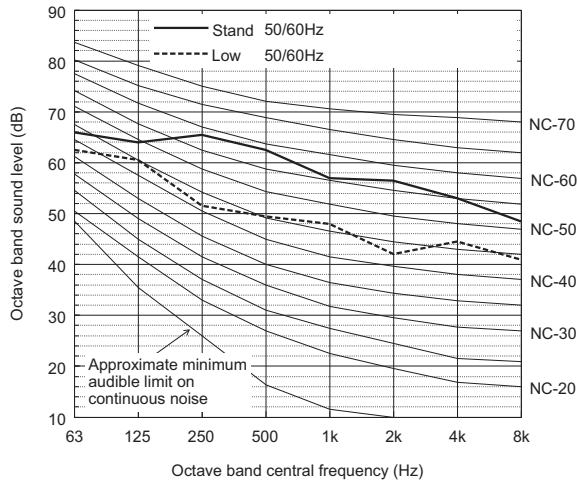

		63	125	250	500	1k	2k	4k	8k	dB(A)
Standard Heating	50/60Hz	66.0	64.0	65.5	62.5	57.0	56.5	53.0	48.5	64.5
Low noise mode	50/60Hz	62.5	60.5	51.5	49.5	48.0	42.0	44.5	41.0	53.5

When Low noise mode is set, the A/C system's capacity is limited. The system could return to normal operation from Low noise mode automatically in the case that the operation condition is severe.

Sound level of PURY-P400YSNW-A(-BS)

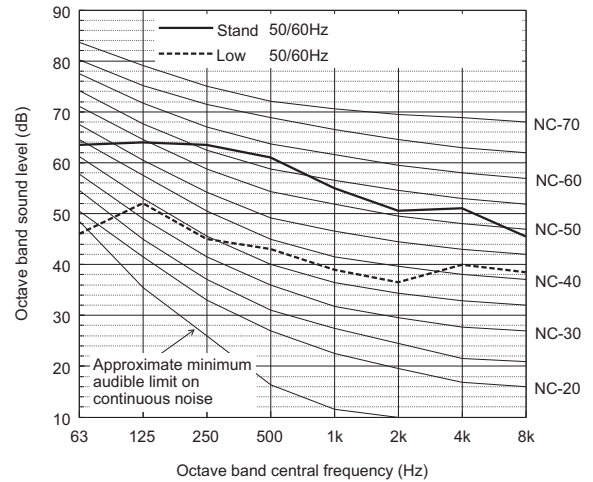

		63	125	250	500	1k	2k	4k	8k	dB(A)
Standard Heating	50/60Hz	63.5	64.0	63.5	61.0	55.0	50.5	51.0	45.5	62.0
Low noise mode	50/60Hz	46.0	52.0	45.0	43.0	39.0	36.5	40.0	38.5	47.0

When Low noise mode is set, the A/C system's capacity is limited. The system could return to normal operation from Low noise mode automatically in the case that the operation condition is severe.

Sound level of PURY-P550YNW-A(-BS)

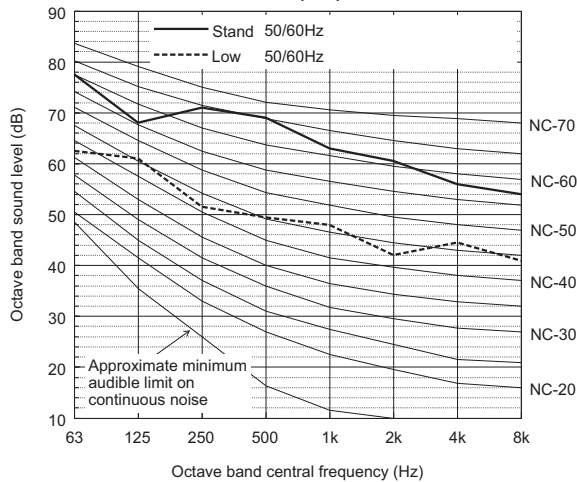

		63	125	250	500	1k	2k	4k	8k	dB(A)
Standard Heating	50/60Hz	77.5	68.0	71.0	69.0	63.0	60.5	56.0	54.0	70.0
Low noise mode	50/60Hz	62.5	61.0	51.5	49.5	48.0	42.0	44.5	41.0	53.5

When Low noise mode is set, the A/C system's capacity is limited. The system could return to normal operation from Low noise mode automatically in the case that the operation condition is severe.

Sound level of PURY-P450YSNW-A(-BS)

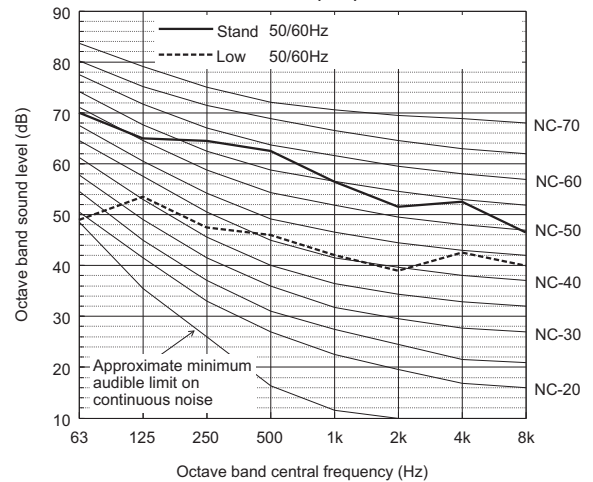

		63	125	250	500	1k	2k	4k	8k	dB(A)
Standard Heating	50/60Hz	70.0	65.0	64.5	62.5	56.5	51.5	52.5	46.5	63.5
Low noise mode	50/60Hz	49.0	53.5	47.5	46.0	42.0	39.0	42.5	40.0	49.5

When Low noise mode is set, the A/C system's capacity is limited. The system could return to normal operation from Low noise mode automatically in the case that the operation condition is severe.

• Depending on the operation conditions, the unit generates noise caused by valve actuation, refrigerant flow, and pressure changes when operating normally. Please consider to avoid location where quietness is required. For BC controller, it is recommended to be installed in places such as ceilings of corridor, rest rooms and plant rooms.

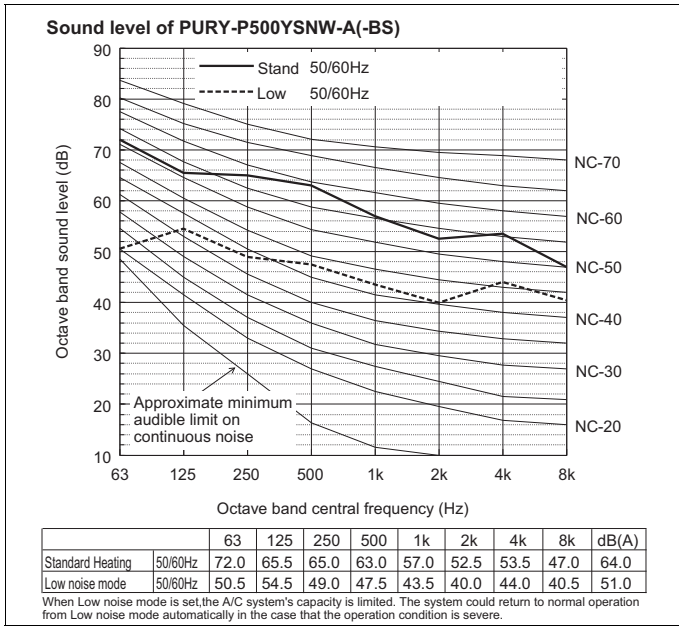

**Measurement condition
PURY-P650YSNW-A(-BS)**

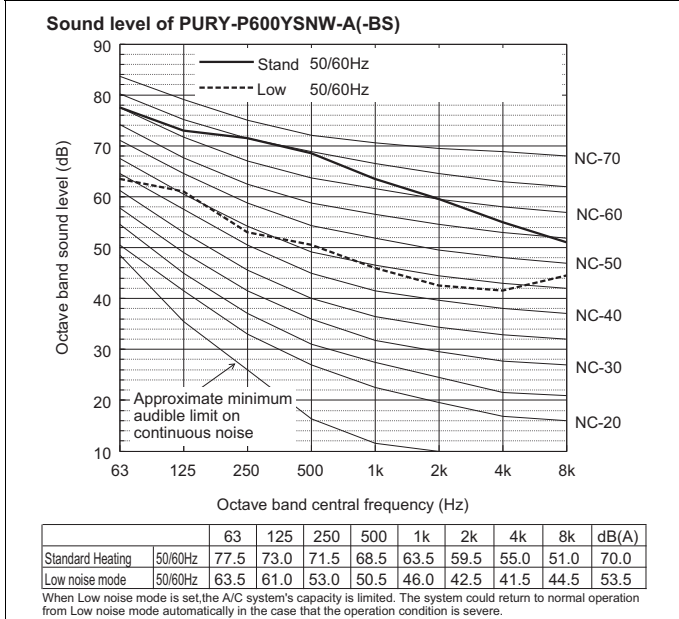
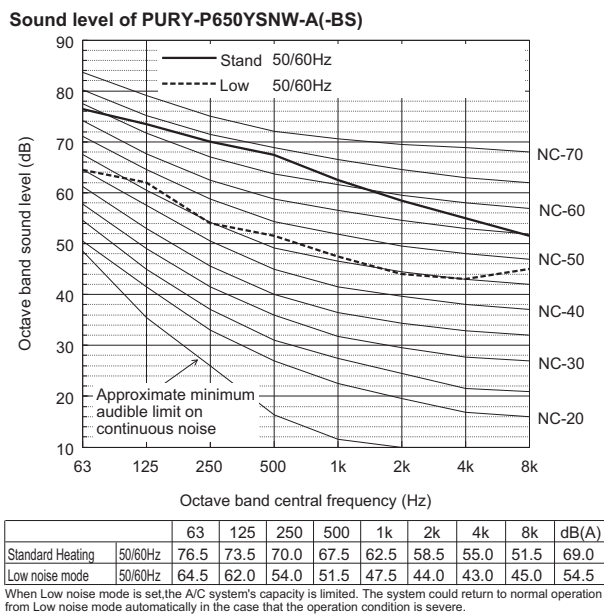
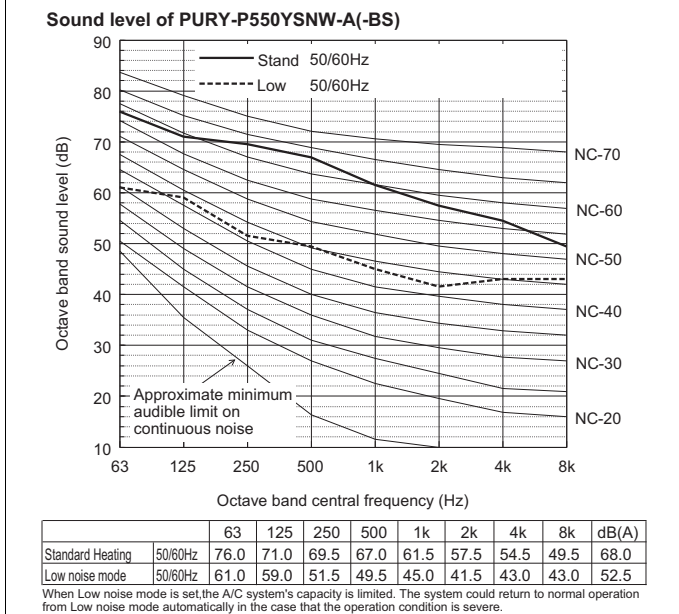
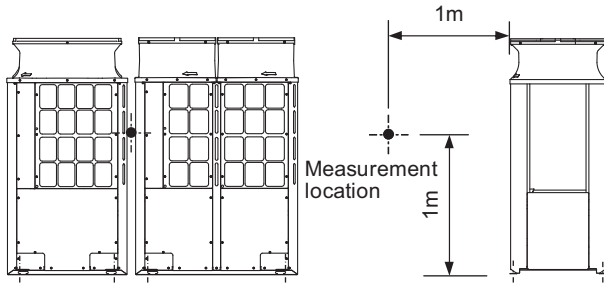

PURY-P-Y(S)NW-A

- Depending on the operation conditions, the unit generates noise caused by valve actuation, refrigerant flow, and pressure changes when operating normally. Please consider to avoid location where quietness is required. For BC controller, it is recommended to be installed in places such as ceilings of corridor, rest rooms and plant rooms.

Measurement condition
PURY-P700, 750, 800, 850, 900YSNW-A(-BS)

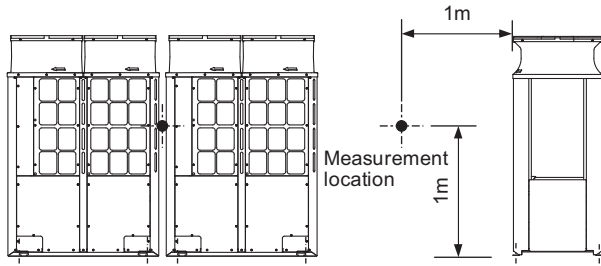

Sound level of PURY-P800YSNW-A(-BS)

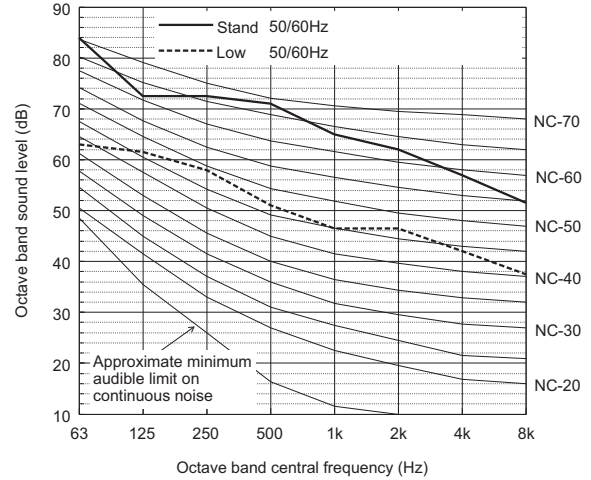

		63	125	250	500	1k	2k	4k	8k	dB(A)
Standard Heating	50/60Hz	84.0	72.5	72.5	71.0	65.0	62.0	57.0	51.5	72.0
Low noise mode	50/60Hz	63.0	61.5	58.0	51.0	46.5	46.5	42.0	37.5	55.0

When Low noise mode is set, the A/C system's capacity is limited. The system could return to normal operation from Low noise mode automatically in the case that the operation condition is severe.

Sound level of PURY-P700YSNW-A(-BS)

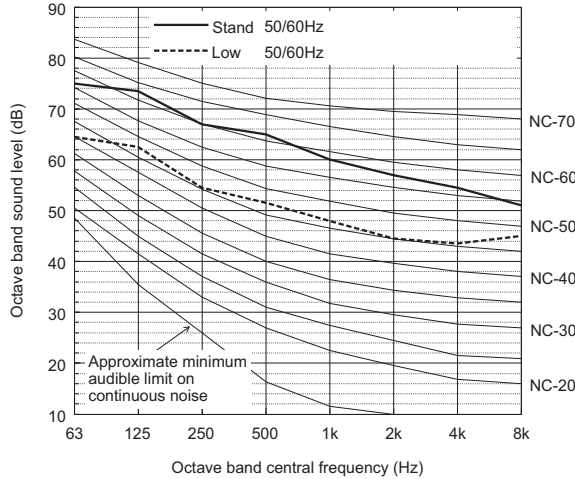

		63	125	250	500	1k	2k	4k	8k	dB(A)
Standard Heating	50/60Hz	75.0	73.5	67.0	65.0	60.0	57.0	54.5	51.0	67.0
Low noise mode	50/60Hz	64.5	62.5	54.5	51.5	48.0	44.5	43.5	45.0	55.0

When Low noise mode is set, the A/C system's capacity is limited. The system could return to normal operation from Low noise mode automatically in the case that the operation condition is severe.

Sound level of PURY-P850YSNW-A(-BS)

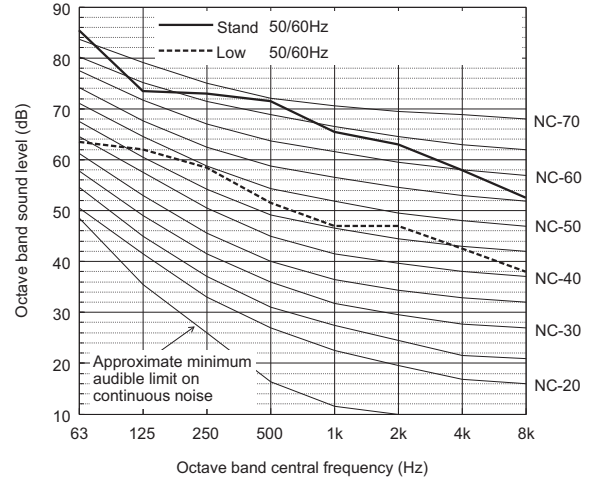

		63	125	250	500	1k	2k	4k	8k	dB(A)
Standard Heating	50/60Hz	85.5	73.5	73.0	71.5	65.5	63.0	58.0	52.5	72.5
Low noise mode	50/60Hz	63.5	62.0	58.5	51.5	47.0	47.0	42.5	38.0	55.5

When Low noise mode is set, the A/C system's capacity is limited. The system could return to normal operation from Low noise mode automatically in the case that the operation condition is severe.

Sound level of PURY-P750YSNW-A(-BS)

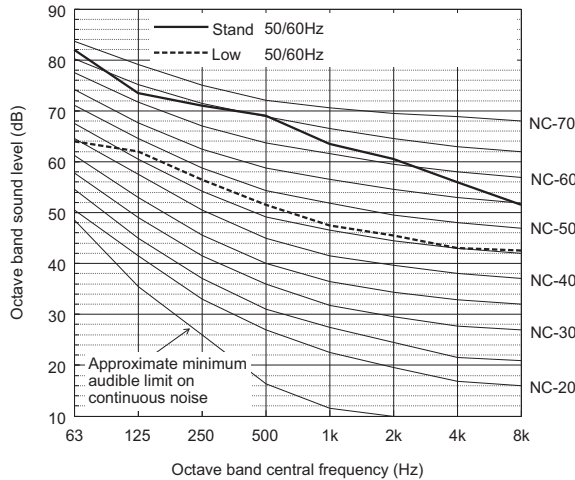

		63	125	250	500	1k	2k	4k	8k	dB(A)
Standard Heating	50/60Hz	82.0	73.5	71.0	69.0	63.5	60.5	56.0	51.5	70.5
Low noise mode	50/60Hz	64.0	62.0	56.5	51.5	47.5	45.5	43.0	42.5	55.0

When Low noise mode is set, the A/C system's capacity is limited. The system could return to normal operation from Low noise mode automatically in the case that the operation condition is severe.

Sound level of PURY-P900YSNW-A(-BS)

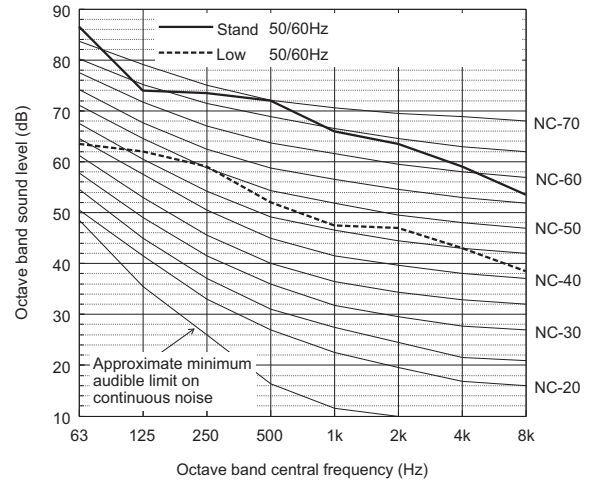

		63	125	250	500	1k	2k	4k	8k	dB(A)
Standard Heating	50/60Hz	86.5	74.0	73.5	72.0	66.0	63.5	59.0	53.5	73.0
Low noise mode	50/60Hz	63.5	62.0	59.0	52.0	47.5	47.0	43.0	38.5	56.0

When Low noise mode is set, the A/C system's capacity is limited. The system could return to normal operation from Low noise mode automatically in the case that the operation condition is severe.

- Depending on the operation conditions, the unit generates noise caused by valve actuation, refrigerant flow, and pressure changes when operating normally. Please consider to avoid location where quietness is required. For BC controller, it is recommended to be installed in places such as ceilings of corridor, rest rooms and plant rooms.

PURY-P-Y(S)NW-A

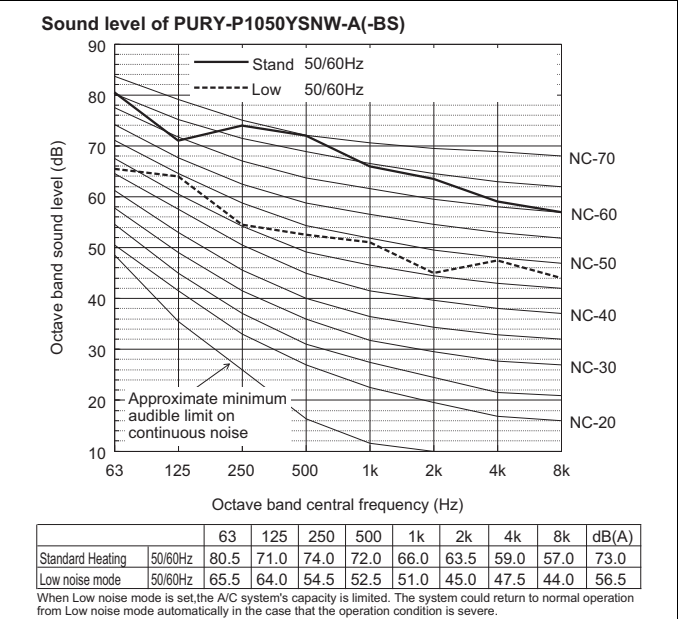
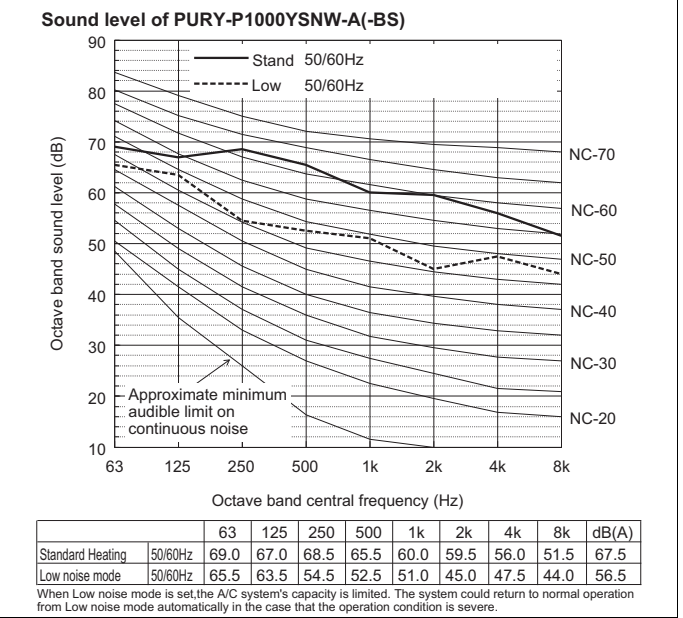
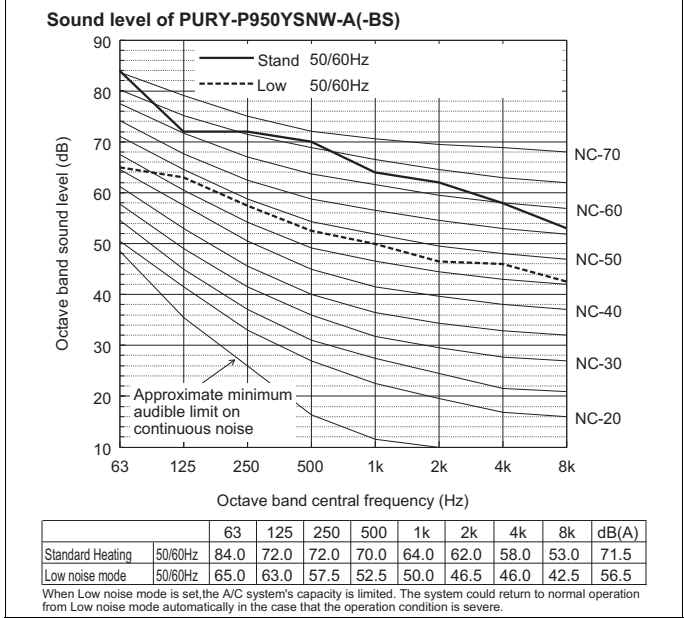
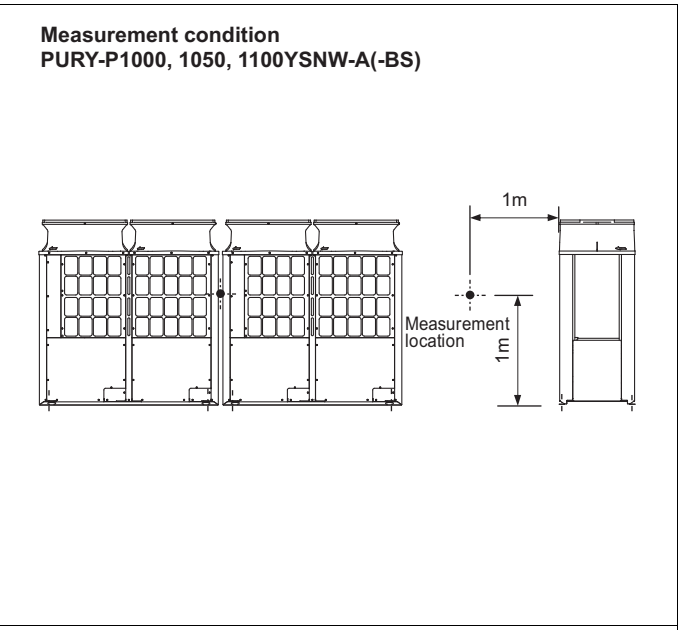
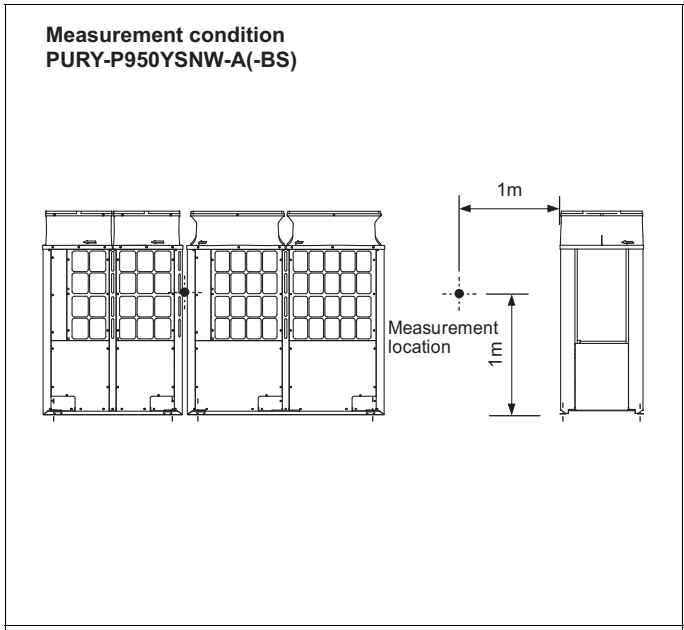

◆ Depending on the operation conditions, the unit generates noise caused by valve actuation, refrigerant flow, and pressure changes when operating normally. Please consider to avoid location where quietness is required. For BC controller, it is recommended to be installed in places such as ceilings of corridor, rest rooms and plant rooms.

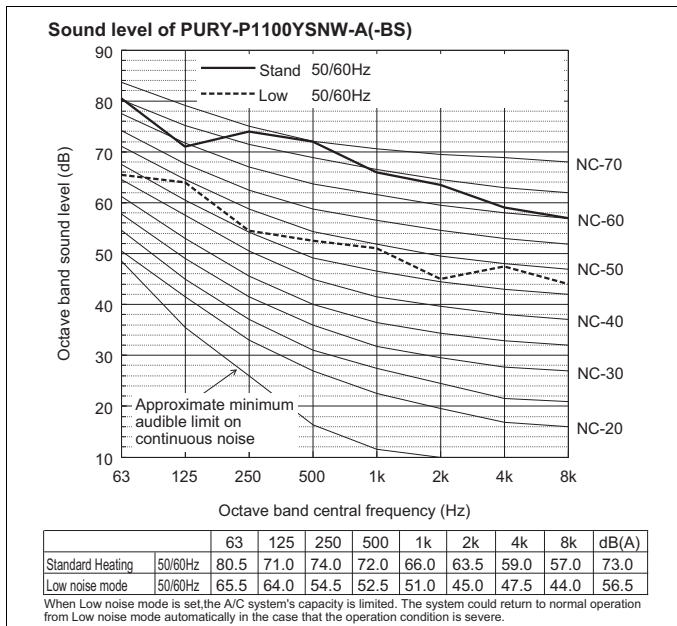

- ◆ Depending on the operation conditions, the unit generates noise caused by valve actuation, refrigerant flow, and pressure changes when operating normally. Please consider to avoid location where quietness is required. For BC controller, it is recommended to be installed in places such as ceilings of corridor, rest rooms and plant rooms.

[PURY-P200-550YNW, PURY-P400-1100YSNW]

Measurement condition

Measurement frequency: 1 Hz-80 Hz

Measurement point: Ground surface 20 cm away from the unit leg

Installation condition: Direct installation on the concrete floor

Power source: 3-phase 4-wire 380-400-415 V 50/60 Hz

Operation condition: JIS condition (cooling, heating)

Measurement device: Vibration level meter for vibration pollution VM-1220C (JIS-compliant product)

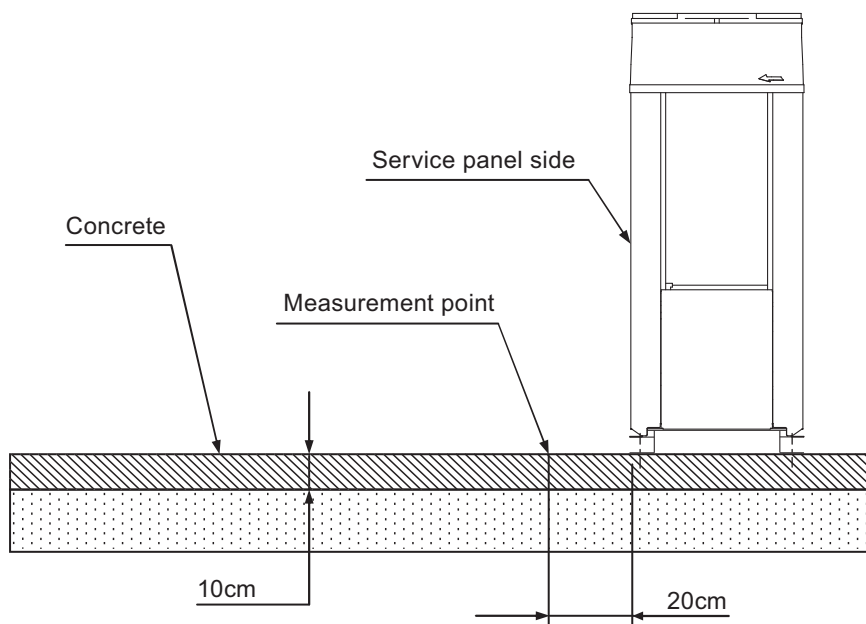

Vibration level

Model	Vibration level (dB)
PURY-P200YNW-A (-BS)	45
PURY-P250YNW-A (-BS)	46
PURY-P300YNW-A (-BS)	47
PURY-P350YNW-A (-BS)	47
PURY-P400YNW-A (-BS)	47
PURY-P450YNW-A (-BS)	47
PURY-P500YNW-A (-BS)	48
PURY-P550YNW-A (-BS)	48
PURY-P400YSNW-A (-BS)	48
PURY-P450YSNW-A (-BS)	48.5
PURY-P500YSNW-A (-BS)	49
PURY-P550YSNW-A (-BS)	49.5
PURY-P600YSNW-A (-BS)	50
PURY-P650YSNW-A (-BS)	50
PURY-P700YSNW-A (-BS)	50
PURY-P750YSNW-A (-BS)	50
PURY-P800YSNW-A (-BS)	50
PURY-P850YSNW-A (-BS)	50
PURY-P900YSNW-A (-BS)	50
PURY-P950YSNW-A (-BS)	50.5
PURY-P1000YSNW-A (-BS)	51
PURY-P1050YSNW-A (-BS)	51
PURY-P1100YSNW-A (-BS)	51

* Vibration level varies depending on the conditions of actual installation site.

7. OPERATION TEMPERATURE RANGE

• Cooling only

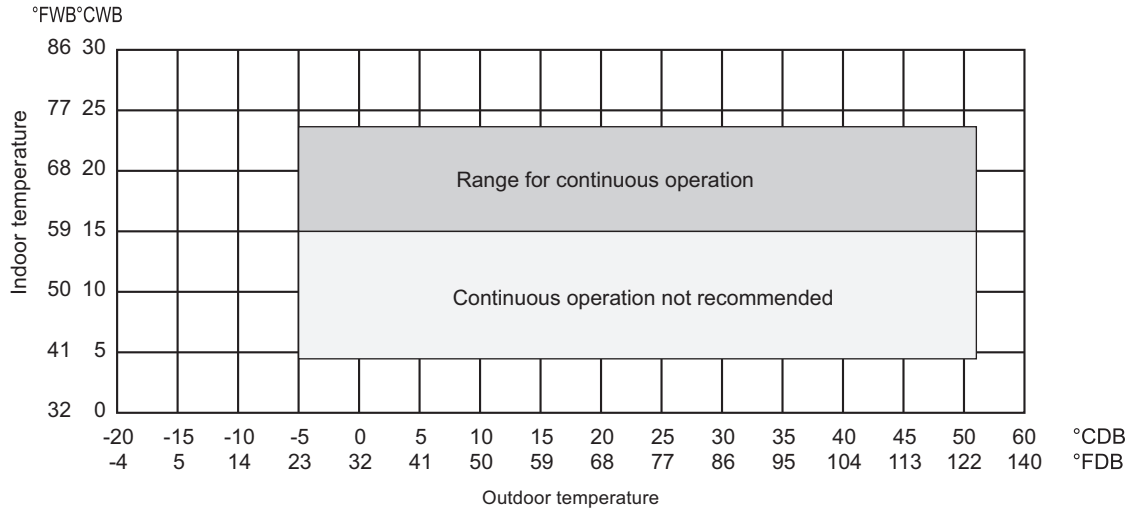

• Heating only

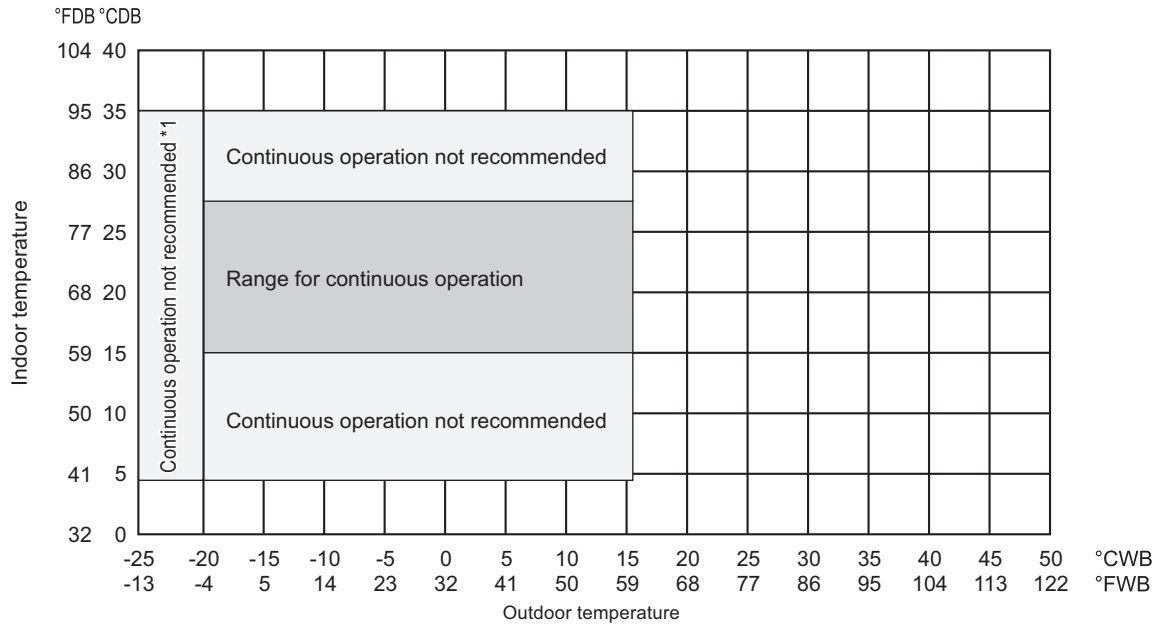

• Combination of cooling/heating operation (Cooling main or Heating main)

Outdoor temperature	Indoor temperature	
	Cooling	Heating
-10 to 21 °CDB (14 to 70 °FDB)	—	15 to 27 °CDB (59 to 81 °FDB)
-11 to 15.5 °CWB (12.2 to 60 °FWB)	15 to 24 °CWB (59 to 75 °FWB)	—

*1 When applying product below -20°CWB, consult your design engineer for cold climate application best practices, including the use of a backup source for heating.

8-1. Selection of Cooling/Heating Units

How to determine the capacity when less than or equal 100% indoor model size units are connected in total:

The purpose of this flow chart is to select the indoor and outdoor units. For other purposes, this flow chart is intended only for reference.

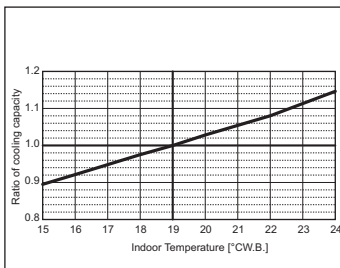
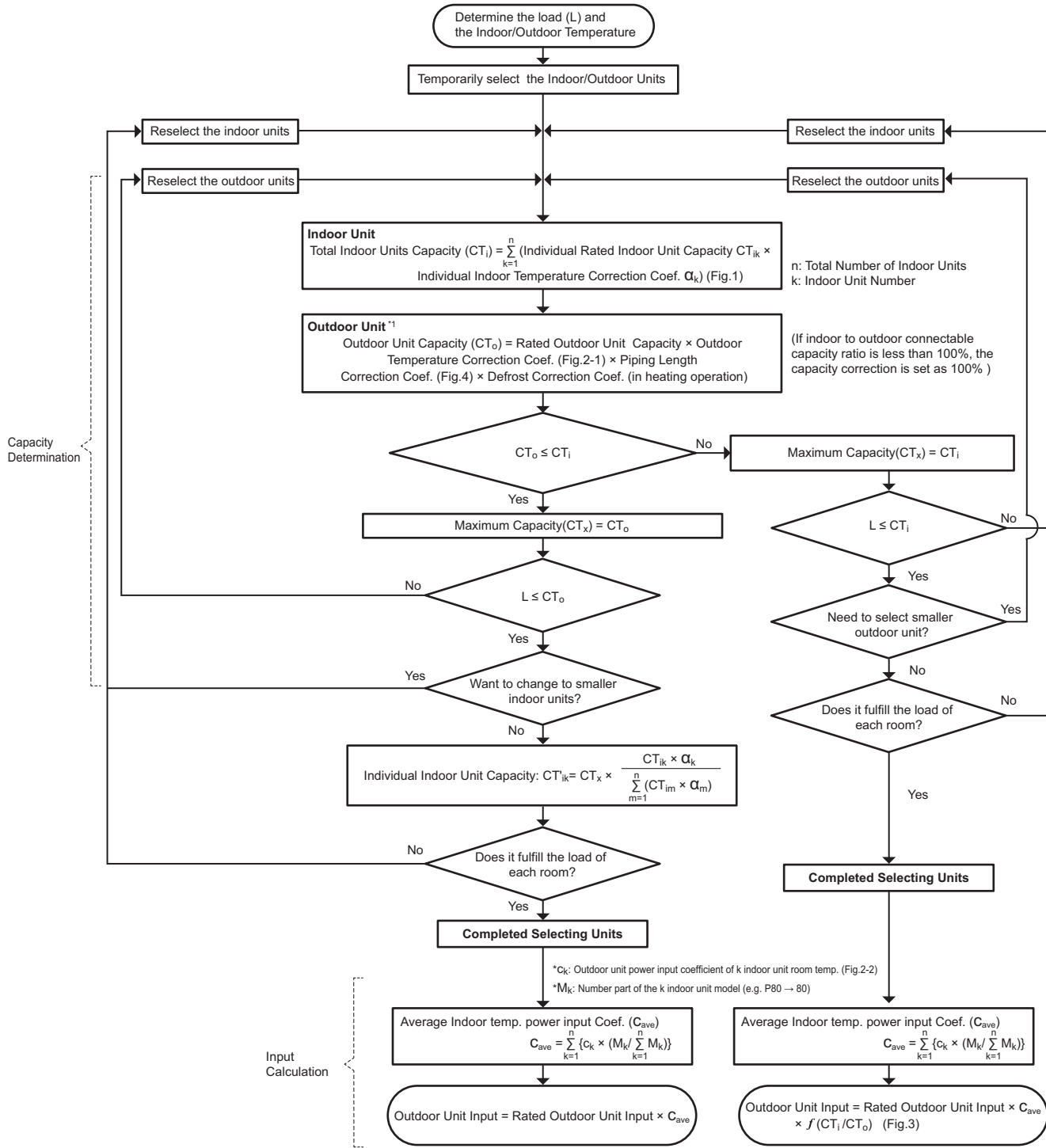

Fig.1 Indoor unit temperature correction

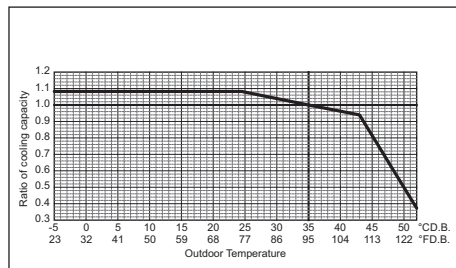

Fig.2-1 Outdoor unit temperature correction (capacity)

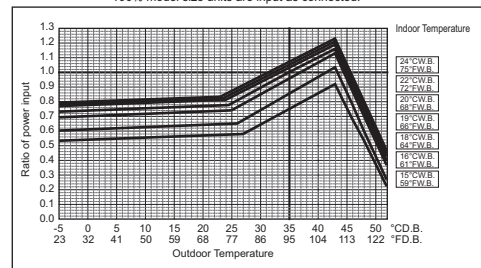

Fig.2-2 Outdoor unit temperature correction (power input)

*1 When the indoor unit sizes from P100 to P140 or total capacity indoor units from P81 to P140 are connected to only 1 port on the BC controller in the R2 system, the cooling capacity of the indoor unit should be multiplied by a correction factor of 0.97.

How to determine the capacity when greater than 100% indoor model size units are connected in total:

The purpose of this flow chart is to select the indoor and outdoor units. For other purposes, this flow chart is intended only for reference.

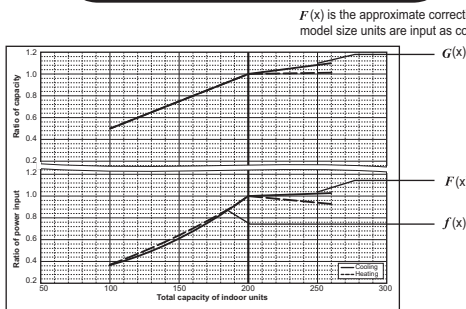
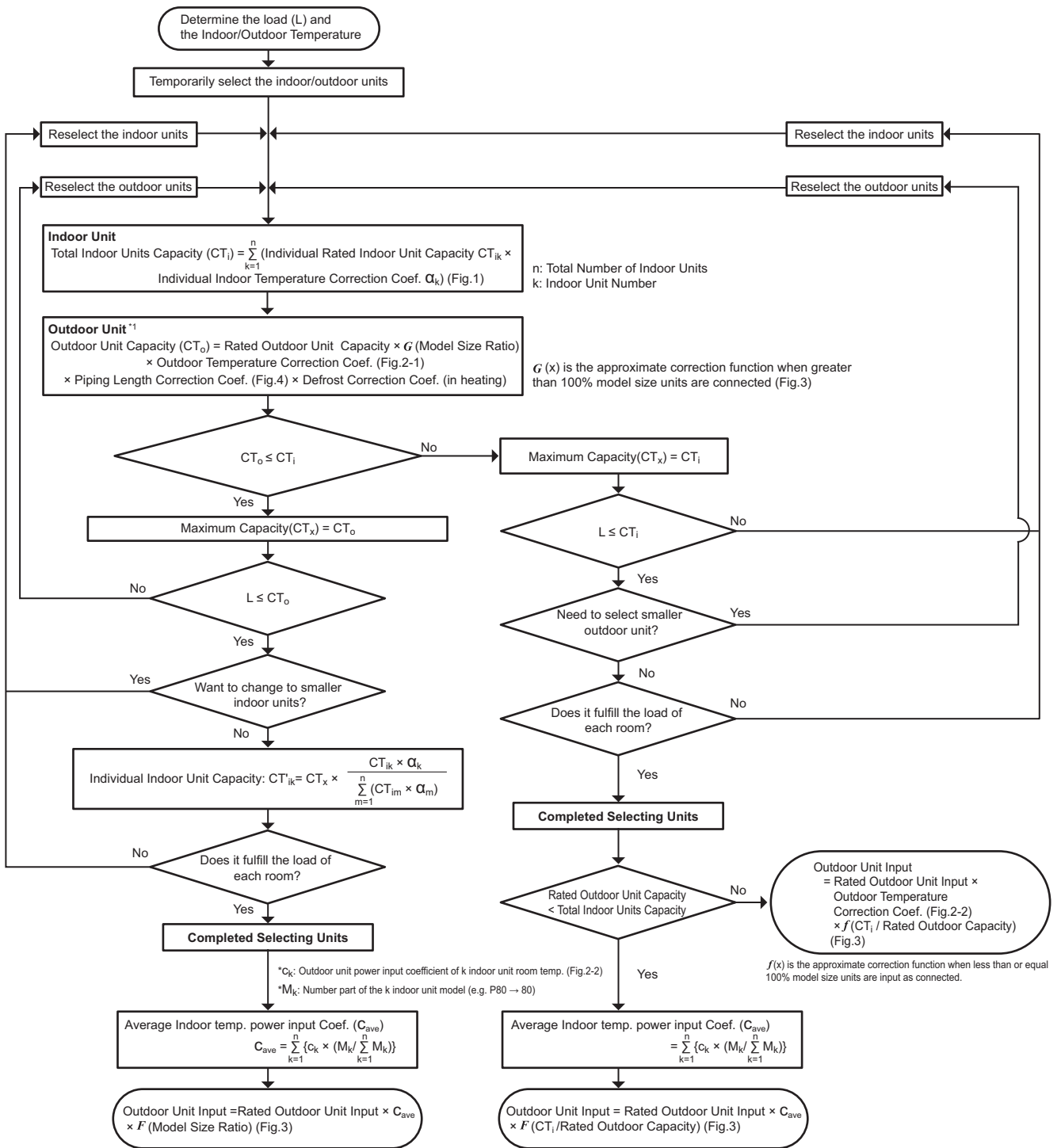

Fig.3 Correction by total indoor

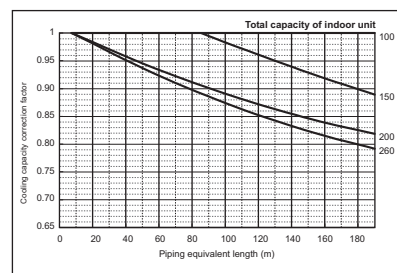

Fig.4 Correction of refrigerant piping length

*1 When the indoor unit sizes from P100 to P140 or total capacity indoor units from P81 to P140 are connected to only 1 port on the BC controller in the R2 system, the cooling capacity of the indoor unit should be multiplied by a correction factor of 0.97.

<Cooling>

Design Condition	
Outdoor Design Dry Bulb Temperature	37 °C
Total Cooling Load	19.0 kW
Room1	
Indoor Design Dry Bulb Temperature	27 °C
Indoor Design Wet Bulb Temperature	20 °C
Cooling Load	9.0 kW
Room2	
Indoor Design Dry Bulb Temperature	24 °C
Indoor Design Wet Bulb Temperature	18 °C
Cooling Load	10.0 kW
<Other>	
Indoor/Outdoor Equivalent Piping Length	50 m

1. Cooling Calculation

(1) Temporary Selection of Indoor Units

Room1	PLFY-P100	11.2 kW (Rated)
Room2	PEFY-P100	11.2 kW (Rated)

(2) Total Indoor Units Capacity

$$P100 + P100 = P200$$

(3) Selection of Outdoor Unit

The P200 outdoor unit is selected as total indoor units capacity is P200

PUHY-EP200	22.4 kW
------------	---------

(4) Total Indoor Units Capacity Correction Calculation

Room1	Indoor Design Wet Bulb Temperature Correction (20°C)	1.03 (Refer to Fig.1)
Room2	Indoor Design Wet Bulb Temperature Correction (18°C)	0.98 (Refer to Fig.1)

Total Indoor Units Capacity (CTi)

$$\begin{aligned} CTi &= \Sigma (\text{Indoor Unit Rating} \times \text{Indoor Design Temperature Correction}) \\ &= 11.2 \times 1.03 + 11.2 \times 0.98 \\ &= 22.5 \text{ kW} \end{aligned}$$

(5) Outdoor Unit Correction Calculation

Outdoor Design Dry Bulb Temperature Correction (37°C)	0.99 (Refer to Fig.2)
Piping Length Correction (50 m)	0.95 (Refer to Fig.3)

Total Outdoor Unit Capacity (CTo)

$$\begin{aligned} CTo &= \text{Outdoor Rating} \times \text{Outdoor Design Temperature Correction} \times \text{Piping Length Correction} \\ &= 22.4 \times 0.99 \times 0.95 \\ &= 21.0 \text{ kW} \end{aligned}$$

(6) Determination of Maximum System Capacity (CTx)

Comparison of Capacity between Total Indoor Units Capacity (CTi) and Total Outdoor Unit Capacity (CTo)

$$CTi = 22.5 > CTo = 21.0, \text{ thus, select } CTo.$$

$$CTx = CTo = 21.0 \text{ kW}$$

(7) Comparison with Essential Load

Against the essential load 19.0kW, the maximum system capacity is 21.0kW: Proper outdoor units have been selected.

(8) Calculation of Maximum Indoor Unit Capacity of Each Room

CTx = CTo, thus, calculate by the calculation below

Room1

$$\begin{aligned} &\text{Maximum Capacity} \times \text{Room1 Capacity after the Temperature Correction} / (\text{Room1,2 Total Capacity after the Temperature Correction}) \\ &= 21.0 \times (11.2 \times 1.03) / (11.2 \times 1.03 + 11.2 \times 0.98) \\ &= 10.8 \text{ kW} \quad \text{OK: fulfills the load 9.0kW} \end{aligned}$$

Room2

$$\begin{aligned} &\text{Maximum Capacity} \times \text{Room2 Capacity after the Temperature Correction} / (\text{Room1,2 Total Capacity after the Temperature Correction}) \\ &= 21.0 \times (11.2 \times 0.98) / (11.2 \times 1.03 + 11.2 \times 0.98) \\ &= 10.2 \text{ kW} \quad \text{OK: fulfills the load 10.0kW} \end{aligned}$$

Go on to the heating trial calculation since the selected units fulfill the cooling loads of Room 1, 2.

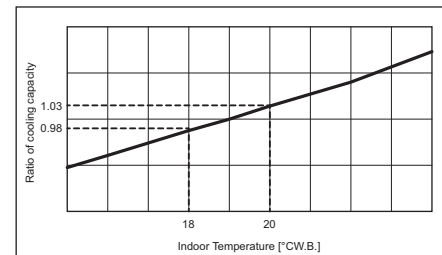

Fig.1 Indoor unit temperature correction
To be used to correct indoor unit only

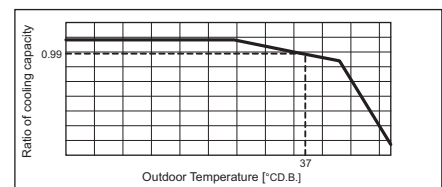

Fig.2 Outdoor unit temperature correction
To be used to correct outdoor unit only

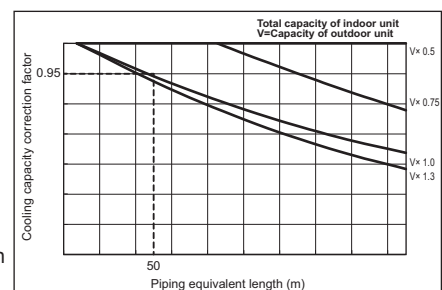

Fig.3 Correction of refrigerant piping length

<Heating>

Design Condition	
Outdoor Design Wet Bulb Temperature	-3 °C
Total Heating Load	18.5 kW
Room1	
Indoor Design Dry Bulb Temperature	25 °C
Heating Load	9.5 kW
Room2	
Indoor Design Dry Bulb Temperature	25 °C
Heating Load	9.0 kW
<Other>	
Indoor/Outdoor Equivalent Piping Length	50 m

2. Heating Calculation

(1) Temporary Selection of Indoor Units

Room1	PLFY-P100	12.5 kW (Rated)
Room2	PEFY-P100	12.5 kW (Rated)

(2) Total Indoor Units Capacity

P100 + P100 = P200

(3) Selection of Outdoor Unit

The P200 outdoor unit is selected as total indoor units capacity is P200

PUHY-EP200	25.0 kW
------------	---------

(4) Total Indoor Units Capacity Correction Calculation

Room1	Indoor Design Dry Bulb Temperature Correction (25°C)	0.80 (Refer to Fig.4)
Room2	Indoor Design Dry Bulb Temperature Correction (25°C)	0.80 (Refer to Fig.4)

Total Indoor Units Capacity (CTi)

$$CTi = \sum (\text{Indoor Unit Rating} \times \text{Indoor Design Temperature Correction})$$

$$= 12.5 \times 0.80 + 12.5 \times 0.80$$

$$= 20.0 \text{ kW}$$

(5) Outdoor Unit Correction Calculation

Outdoor Design Wet Bulb Temperature Correction (-3°C)	0.98 (Refer to Fig.5)
Piping Length Correction (60 m)	0.97 (Refer to Fig.6)
Defrost Correction	0.89 (Refer to Tbl.1)

Total Outdoor Unit Capacity (CTo)

$$CTo = \text{Outdoor Unit Rating} \times \text{Outdoor Design Temperature Correction} \times \text{Piping Length Correction} \times \text{Defrost Correction}$$

$$= 25.0 \times 0.98 \times 0.97 \times 0.89$$

$$= 21.1 \text{ kW}$$

(6) Determination of Maximum System Capacity (CTx)

Comparison of Capacity between Total Indoor Units Capacity (CTi) and Total Outdoor Unit Capacity (CTo)

CTi = 20.0 < CTo = 21.1, thus, select CTi.

CTx = CTi = 20.0 kW

(7) Comparison with Essential Load

Against the essential load 18.5kW, the maximum system capacity is 20.0kW: Proper outdoor units have been selected.

(8) Calculation of Maximum Indoor Unit Capacity of Each Room

CTx = CTi, thus, calculate by the calculation below

Room1	Indoor Unit Rating × Indoor Design Temperature Correction	OK: fulfills the load 9.5kW
	= 12.5 × 0.80	
	= 10.0 kW	

Room2	Indoor Unit Rating × Indoor Design Temperature Correction	OK: fulfills the load 9.0kW
	= 12.5 × 0.80	
	= 10.0 kW	

Completed selecting units since the selected units fulfill the heating loads of Room 1, 2.

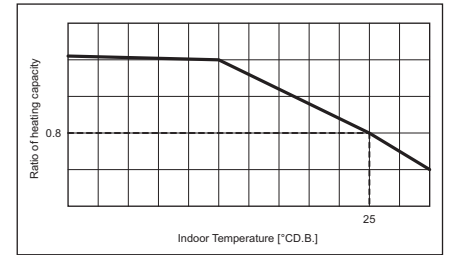

Fig.4 Indoor unit temperature correction
To be used to correct indoor unit only

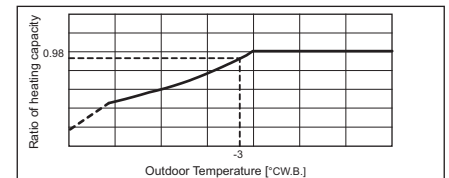

Fig.5 Outdoor unit temperature correction
To be used to correct outdoor unit only

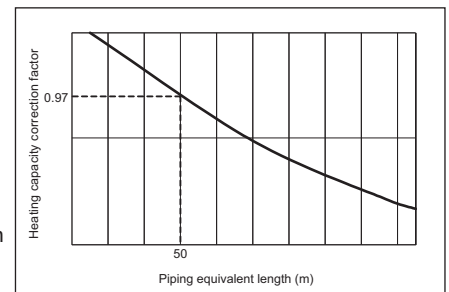

Fig.6 Correction of refrigerant piping length

Tbl.1 Table of correction factor at frost and defrost

Outdoor inlet air temp. °CWB	6	4	2	1	0	-2	-4	-6	-8	-10	-20
Outdoor inlet air temp. °FWB	43	39	36	34	32	28	25	21	18	14	-4
PUHY-P200	1.00	0.95	0.84	0.825	0.83	0.87	0.90	0.95	0.95	0.95	0.95
PUHY-P250	1.00	0.95	0.84	0.825	0.83	0.87	0.90	0.95	0.95	0.95	0.95
PUHY-P300	1.00	0.93	0.82	0.80	0.82	0.86	0.90	0.90	0.95	0.95	0.95
PUHY-P350	1.00	0.93	0.85	0.83	0.84	0.86	0.90	0.90	0.95	0.95	0.95
PUHY-P400	1.00	0.93	0.85	0.83	0.84	0.86	0.90	0.90	0.95	0.95	0.95

3. Power input of outdoor unit

<Cooling>

(1) Rated power input of outdoor unit **5.19 kW****(2) Calculation of the average indoor temperature power input coefficient**

Coefficient of the outdoor unit for indoor unit 1 (Outdoor temp. 37 °CD.B., Indoor temp. 20 °CW.B.)

1.07

Coefficient of the outdoor unit for indoor unit 2 (Outdoor temp. 37 °CD.B., Indoor temp. 18 °CW.B.)

1.00

$$\text{Average indoor temp. power input coefficient } (C_{\text{ave}}) = \sum_{k=1}^n \{c_k \times (M_k / \sum_{k=1}^n M_k)\}$$

n: Total number of the indoor units

k: Number of the indoor unit

c_k: Outdoor unit power input coefficient of k indoor unit room temp.M_k: Number part of the k indoor unit model (e.g. P80 → 80)

$$= 1.07 \times 100 / (100 + 100) + 1 \times 100 / (100 + 100)$$

$$= 1.04$$

(3) No need to consider Coefficient of the partial load $f(CTi/CTo)$ -**(4) Outdoor power input (P_{lo})**Maximum System Capacity (CT_x) = Total Outdoor unit Capacity (CT_o), so use the following formulaP_{lo} = Outdoor unit Cooling Rated Power Input × Correction Coefficient of Indoor temperature

$$= 5.19 \times 1.04$$

$$= 5.4 \text{ kW}$$

<Heating>

(1) Rated power input of outdoor unit **5.73 kW****(2) Calculation of the average indoor temperature power input coefficient**Coefficient of the outdoor unit for indoor unit 1 (Outdoor temp. -3 °CW.B., Indoor temp. 25 °CD.B.)
1.08Coefficient of the outdoor unit for indoor unit 2 (Outdoor temp. -3 °CW.B., Indoor temp. 25 °CD.B.)
1.08

$$\text{Average indoor temp. power input coefficient } (C_{ave}) = \sum_{k=1}^n \{c_k \times (M_k / \sum_{k=1}^n M_k)\}$$

n: Total number of the indoor units

k: Number of the indoor unit

c_k: Outdoor unit power input coefficient of k indoor unit room temp.M_k: Number part of the k indoor unit model (e.g. P80 → 80)

$$= 1.08 \times 100 / (100 + 100) + 1.08 \times 100 / (100 + 100)$$

$$= 1.08$$

(3) Coefficient of the partial load f (CTi/CTo) **0.91****(4) Outdoor power input (P_{lo})**Maximum System Capacity (CT_x) = Total Indoor unit Capacity (CT_i), so use the following formula

$$P_{lo} = \text{Outdoor unit Heating Rated Power Input} \times \text{Correction Coefficient of Indoor temperature} \times f(\text{CT}_i/\text{CT}_o)$$

$$= 5.73 \times 1.08 \times 0.91$$

$$= 5.65 \text{ kW}$$

8-2. Correction by temperature

CITY MULTI could have varied capacity at different designing temperature. Using the nominal cooling/heating capacity value and the ratio below, the capacity can be observed at various temperature.

PURY-		P200YNW-A	P250YNW-A
Cooling Capacity	kW	22.4	28.0
	BTU/h	76,400	95,500
Input	kW	4.43	5.97

Indoor unit temperature correction

To be used to correct indoor unit capacity only

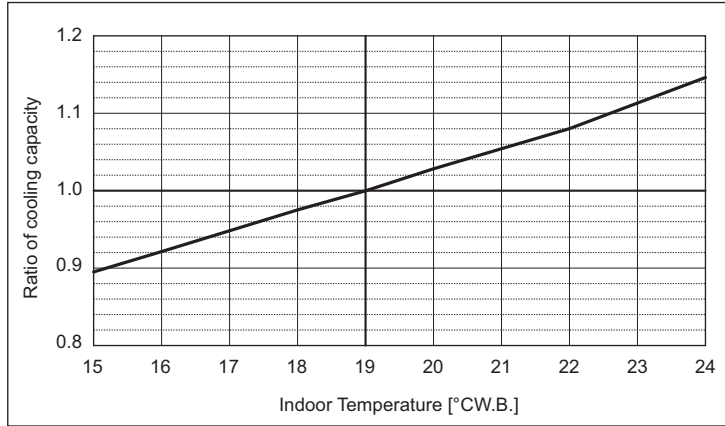

Outdoor unit temperature correction

To be used to correct outdoor unit only

Outdoor unit capacity is NOT affected by the indoor temperature.

Outdoor unit power input is affected by the indoor and outdoor temperatures. Please consult the sales office for details.

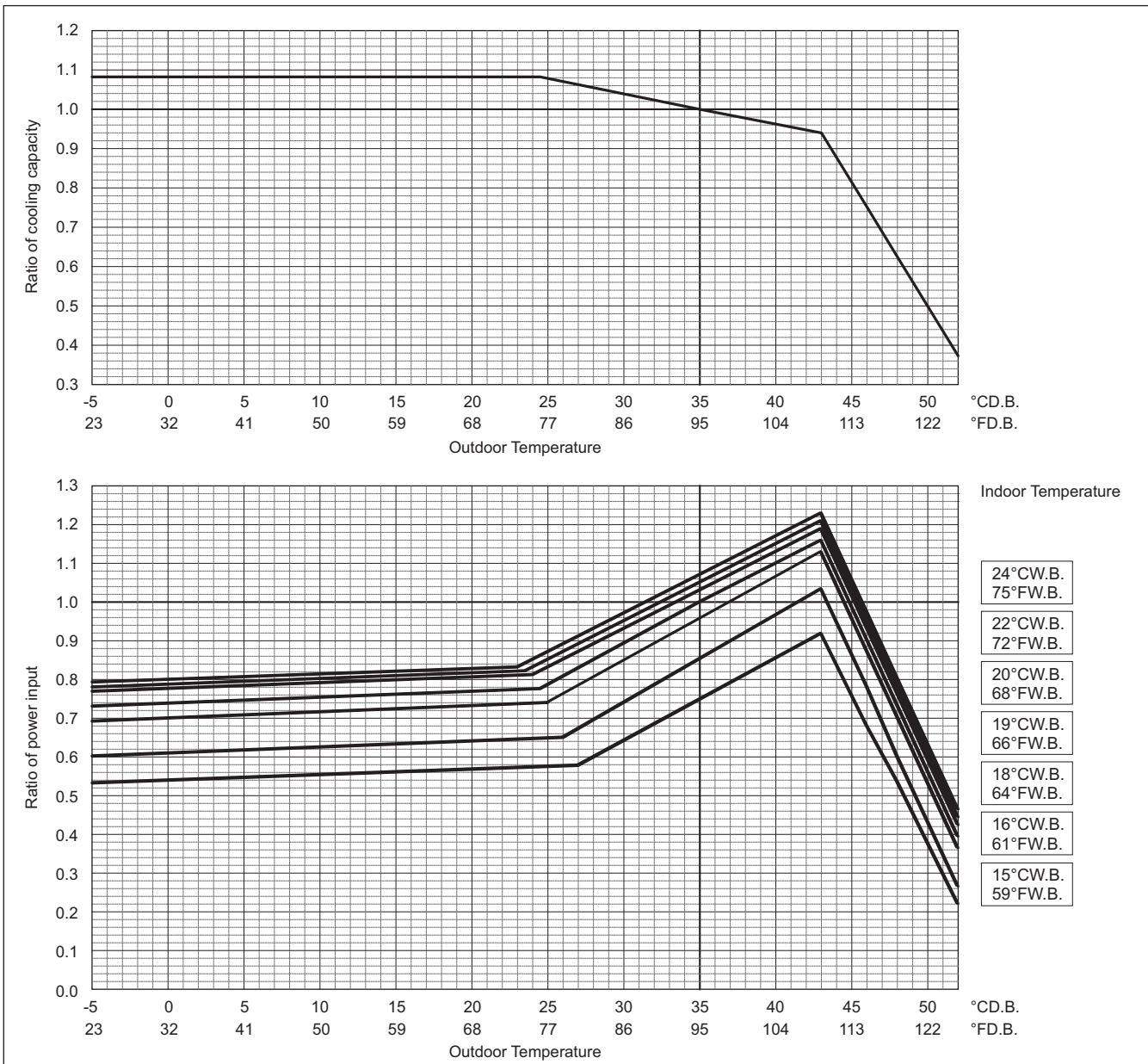

PURY-P-Y(S)NW-A

8. CAPACITY TABLES

	PURY-	P200YNW-A	P250YNW-A
Heating Capacity	kW	25.0	31.5
Capacity	BTU/h	85,300	107,500
Input	kW	4.71	6.06

Indoor unit temperature correction

To be used to correct indoor unit capacity only

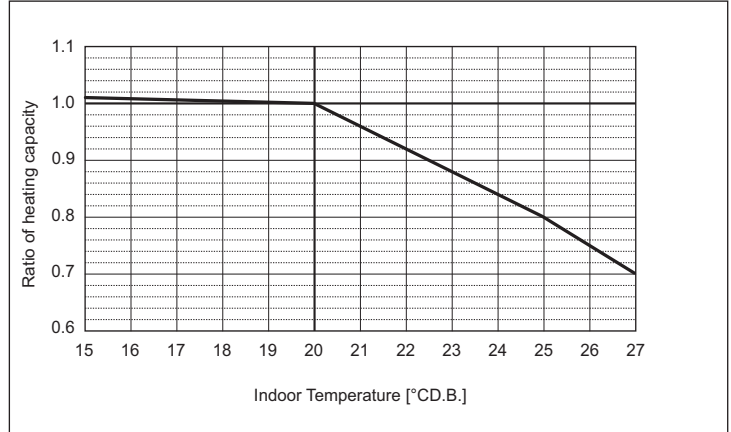

Outdoor unit temperature correction

To be used to correct outdoor unit only

Outdoor unit capacity is NOT affected by the indoor temperature.

Outdoor unit power input is affected by the indoor and outdoor temperatures. Please consult the sales office for details.

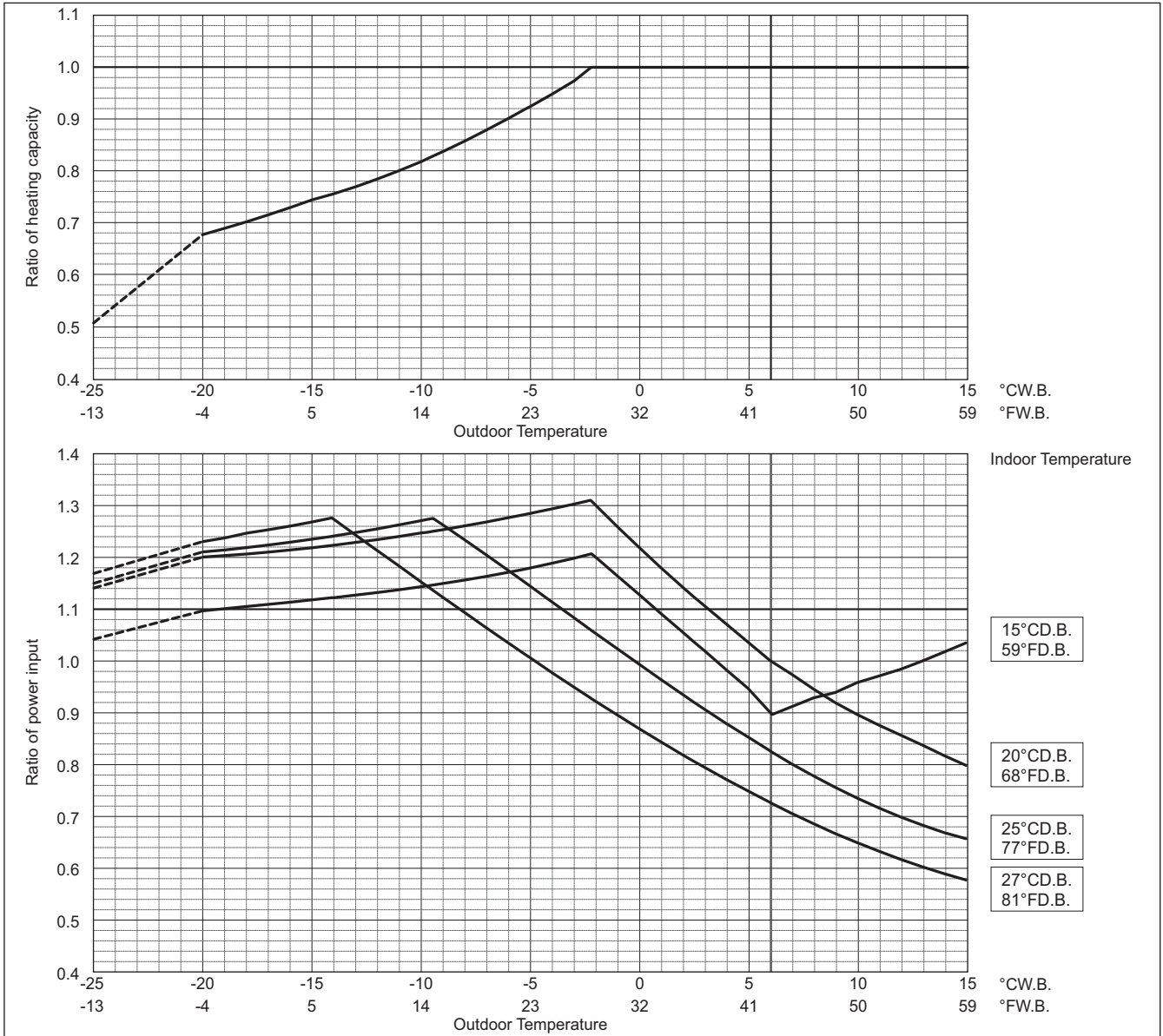

Values in the heating temperature correction diagram in the range below -20°C (-4°F) are reference values and not guaranteed values. Do not use these reference values for selecting outdoor unit models.

When applying product below -20°C (-4°F), consult your design engineer for cold climate application best practices, including the use of a backup source for heating.

PURY-P-Y(S)NW-A

8. CAPACITY TABLES

Outdoor units

PURY-		P300YNW-A	P350YNW-A
Cooling Capacity	kW	33.5	40.0
	BTU/h	114,300	136,500
Input	kW	7.54	10.04

Indoor unit temperature correction

To be used to correct indoor unit capacity only

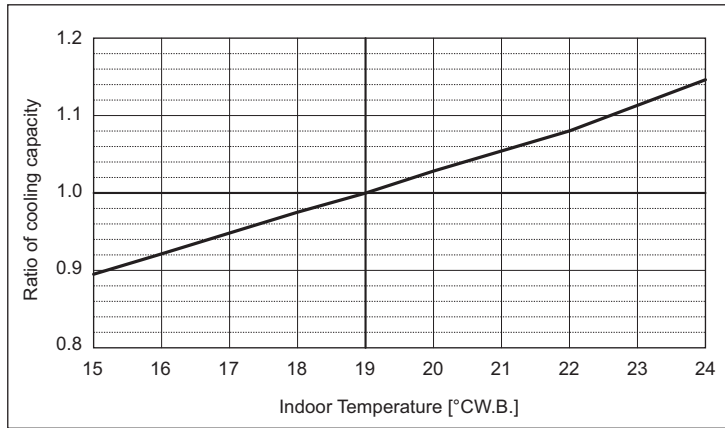

Outdoor unit temperature correction

To be used to correct outdoor unit only

Outdoor unit capacity is NOT affected by the indoor temperature.

Outdoor unit power input is affected by the indoor and outdoor temperatures. Please consult the sales office for details.

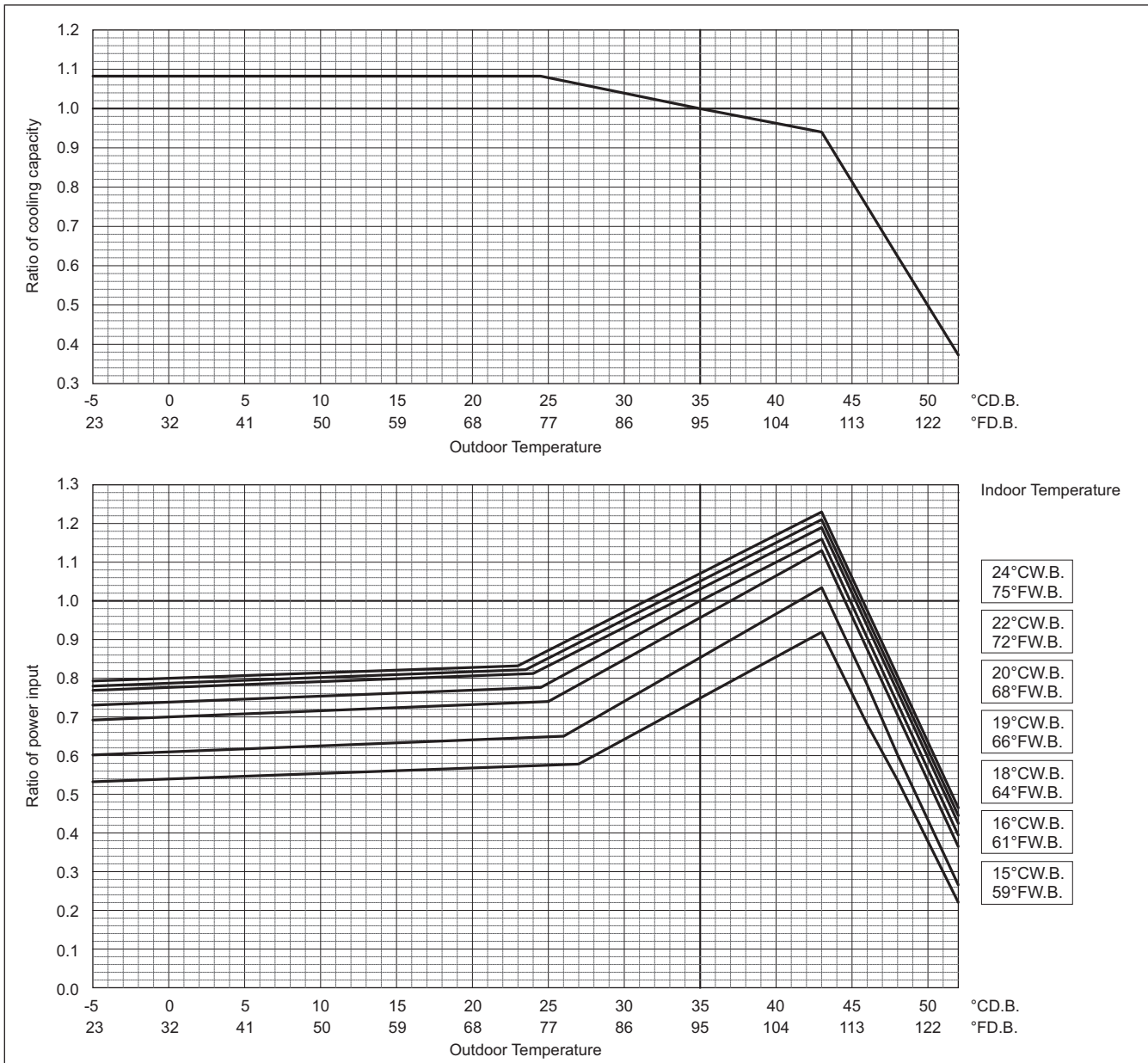

PURY-P-Y(S)NW-A

	PURY-	P300YNW-A	P350YNW-A
Heating Capacity	kW	37.5	45.0
	BTU/h	128,000	153,500
Input	kW	8.38	10.68

Indoor unit temperature correction

To be used to correct indoor unit capacity only

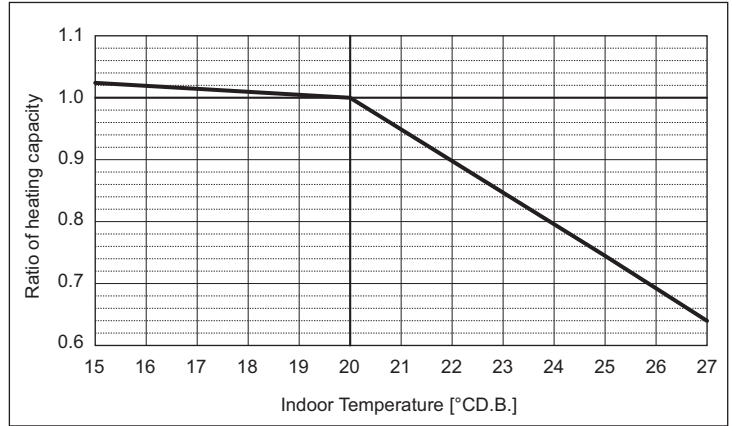

Outdoor unit temperature correction

To be used to correct outdoor unit only

Outdoor unit capacity is NOT affected by the indoor temperature.

Outdoor unit power input is affected by the indoor and outdoor temperatures. Please consult the sales office for details.

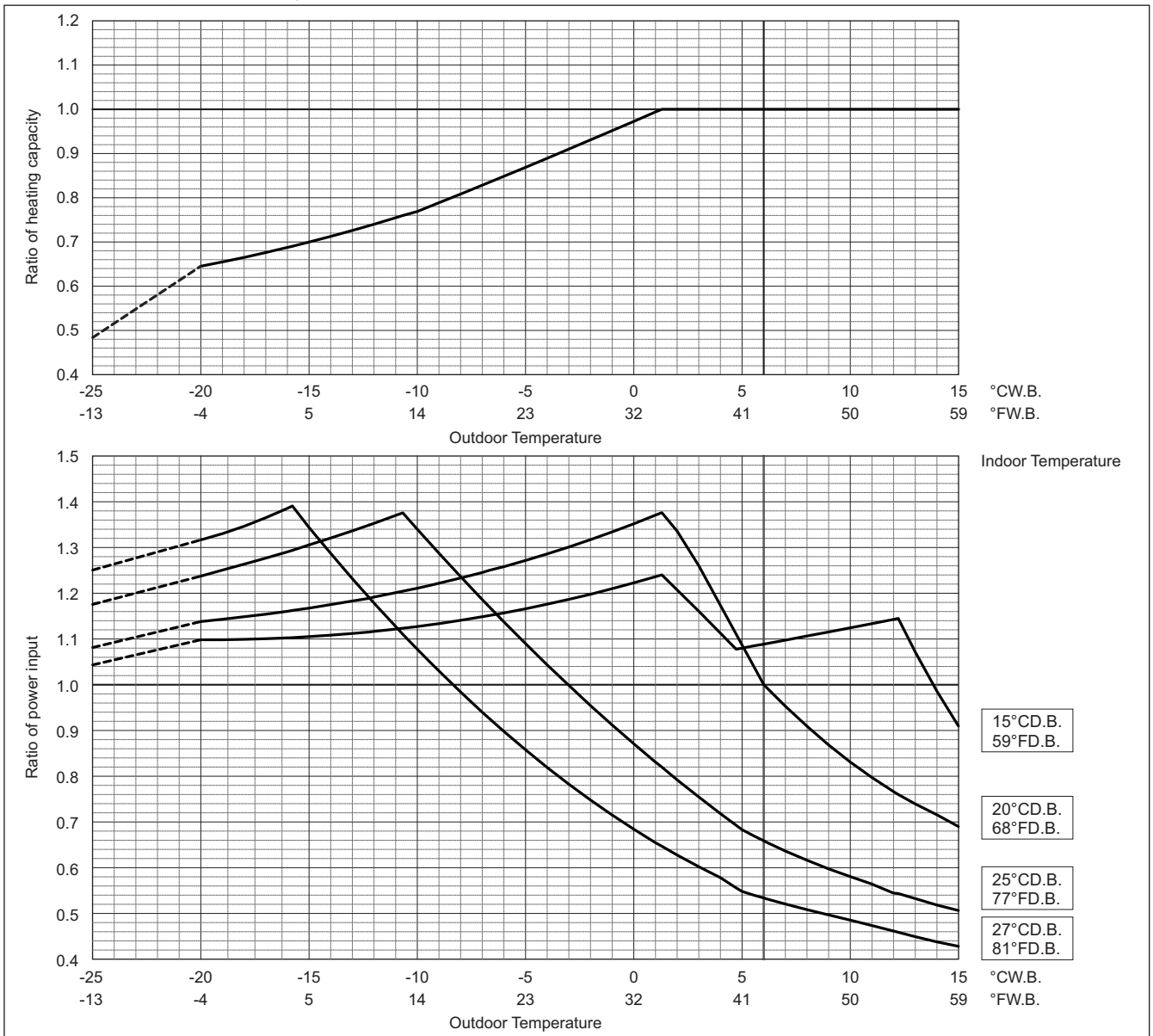

Values in the heating temperature correction diagram in the range below -20°C (-4°F) are reference values and not guaranteed values. Do not use these reference values for selecting outdoor unit models.

When applying product below -20°C (-4°F), consult your design engineer for cold climate application best practices, including the use of a backup source for heating.

8. CAPACITY TABLES

Outdoor units

PURY-		P400YNW-A	P450YNW-A	P500YNW-A
Cooling Capacity	kW	45.0	50.0	56.0
	BTU/h	153,500	170,600	191,100
Input	kW	11.59	12.37	12.72

Indoor unit temperature correction

To be used to correct indoor unit capacity only

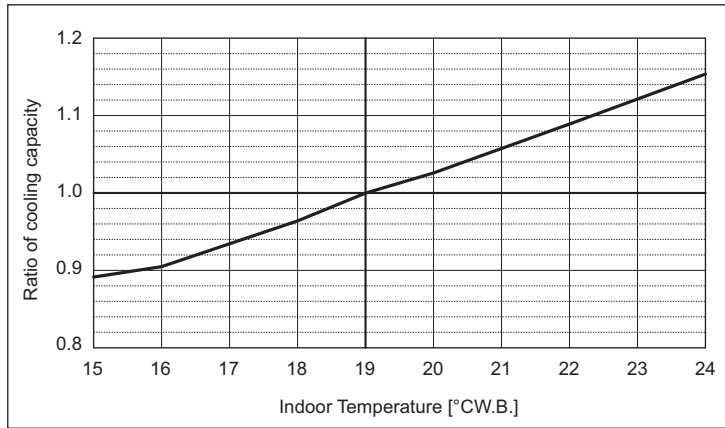

Outdoor unit temperature correction

To be used to correct outdoor unit only

Outdoor unit capacity is NOT affected by the indoor temperature.

Outdoor unit power input is affected by the indoor and outdoor temperatures. Please consult the sales office for details.

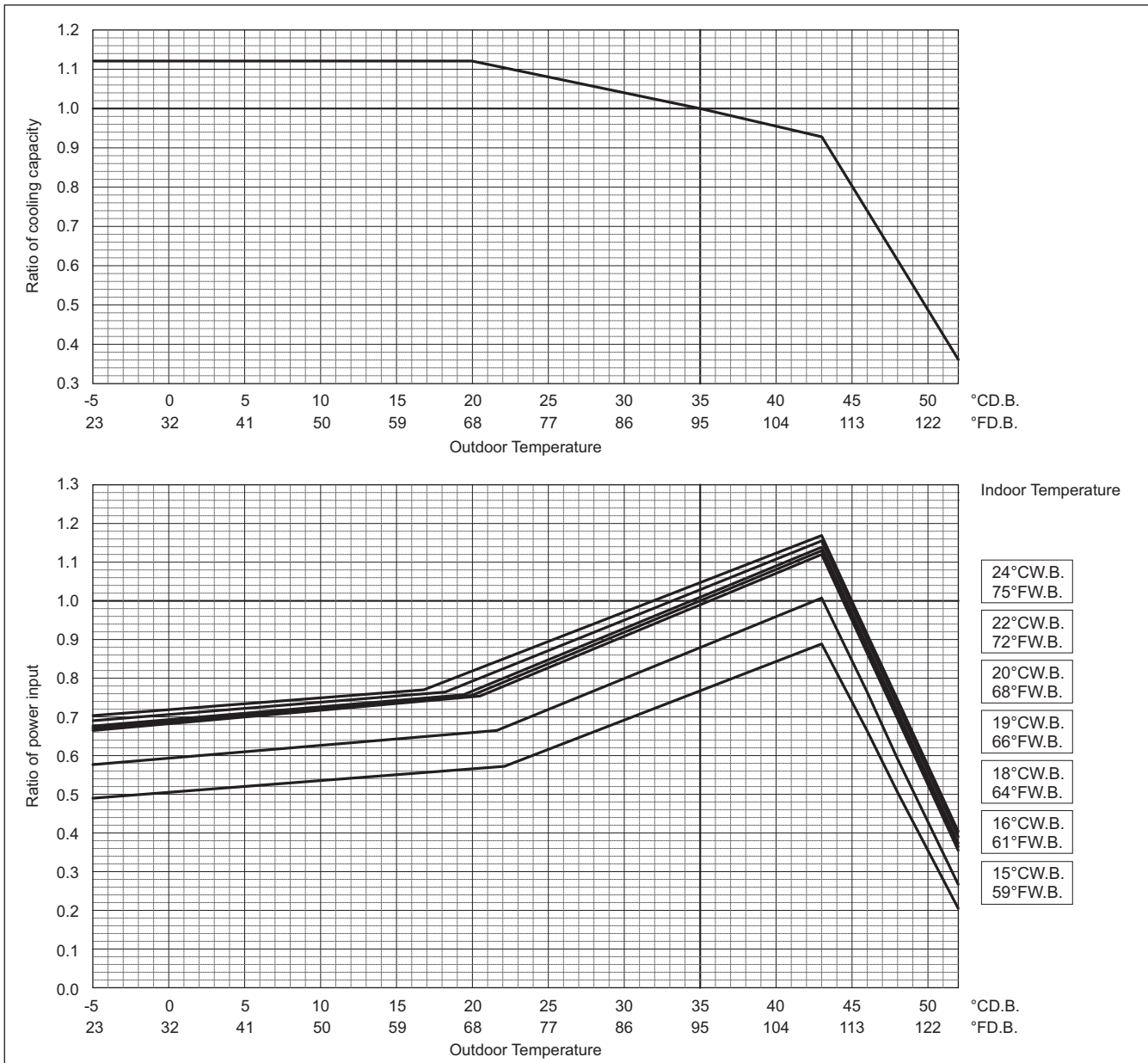

PURY-P-Y(S)NW-A

8. CAPACITY TABLES

	PURY-	P400YNW-A	P450YNW-A	P500YNW-A
Heating Capacity	kW	50.0	56.0	63.0
	BTU/h	170,600	191,100	215,000
Input	kW	13.65	13.48	15.28

Indoor unit temperature correction
To be used to correct indoor unit capacity only

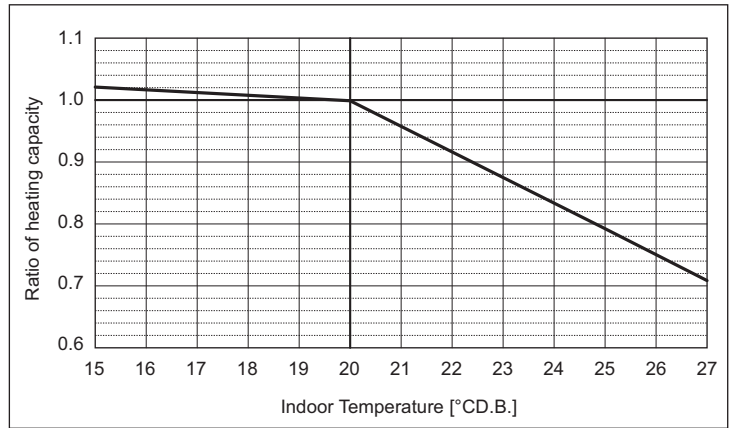

Outdoor unit temperature correction

To be used to correct outdoor unit only

Outdoor unit capacity is NOT affected by the indoor temperature.

Outdoor unit power input is affected by the indoor and outdoor temperatures. Please consult the sales office for details.

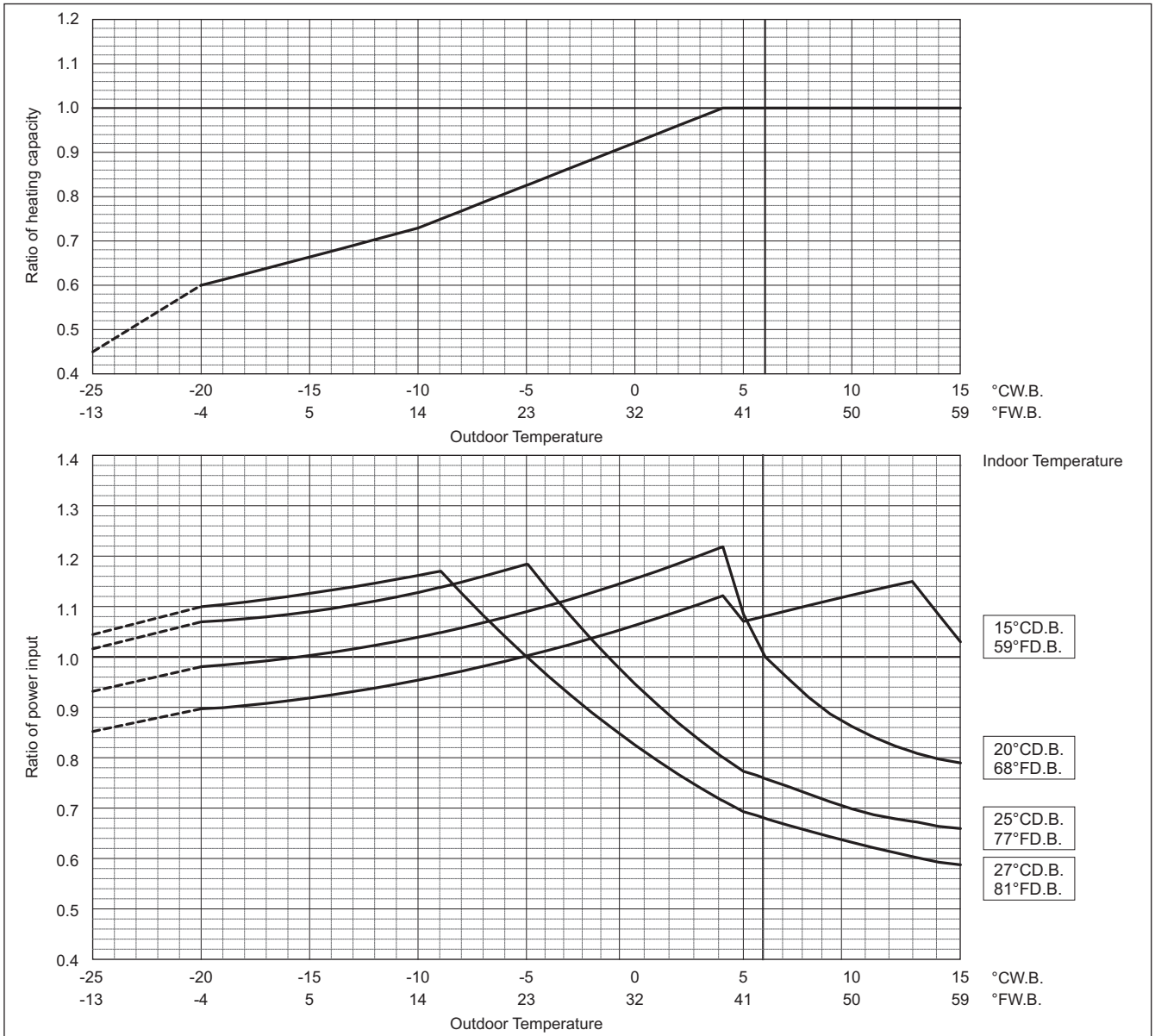

Values in the heating temperature correction diagram in the range below -20°C (-4°F) are reference values and not guaranteed values. Do not use these reference values for selecting outdoor unit models.
When applying product below -20°C (-4°F), consult your design engineer for cold climate application best practices, including the use of a backup source for heating.

PURY-P-Y(S)NW-A

8. CAPACITY TABLES

Outdoor units

PURY-		P550YNW-A
Cooling Capacity	kW	63.0
	BTU/h	215,000
Input	kW	16.03

Indoor unit temperature correction

To be used to correct indoor unit capacity only

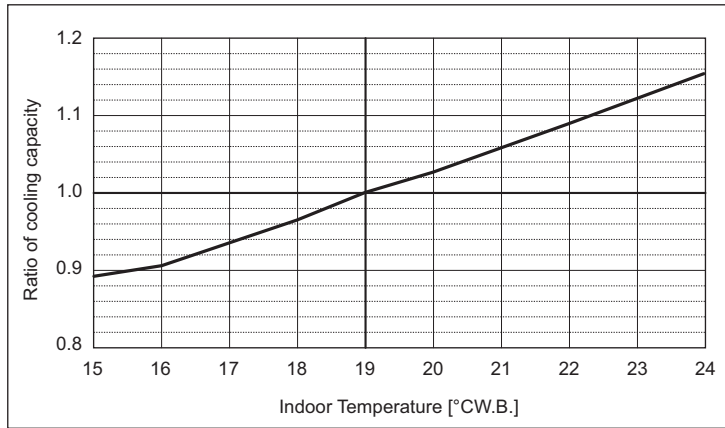

Outdoor unit temperature correction

To be used to correct outdoor unit only

Outdoor unit capacity is NOT affected by the indoor temperature.

Outdoor unit power input is affected by the indoor and outdoor temperatures. Please consult the sales office for details.

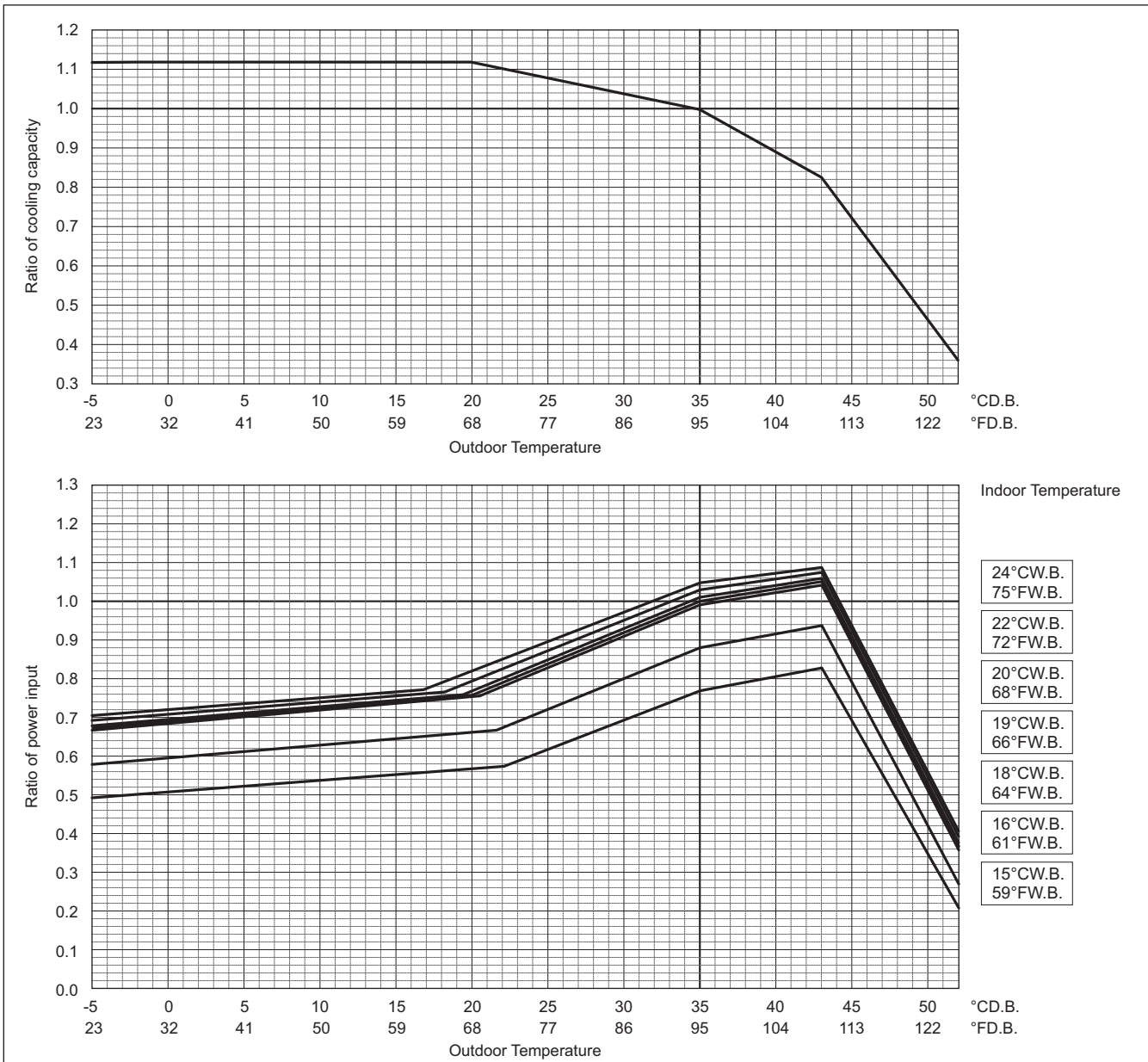

PURY-P-Y(S)NW-A

	PURY-	P550YNW-A
Heating Capacity	kW	69.0
	BTU/h	235,400
Input	kW	17.91

Indoor unit temperature correction

To be used to correct indoor unit capacity only

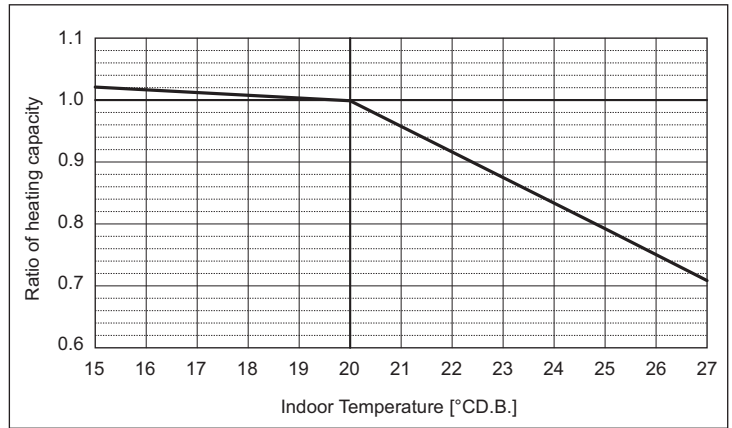

Outdoor unit temperature correction

To be used to correct outdoor unit only

Outdoor unit capacity is NOT affected by the indoor temperature.

Outdoor unit power input is affected by the indoor and outdoor temperatures. Please consult the sales office for details.

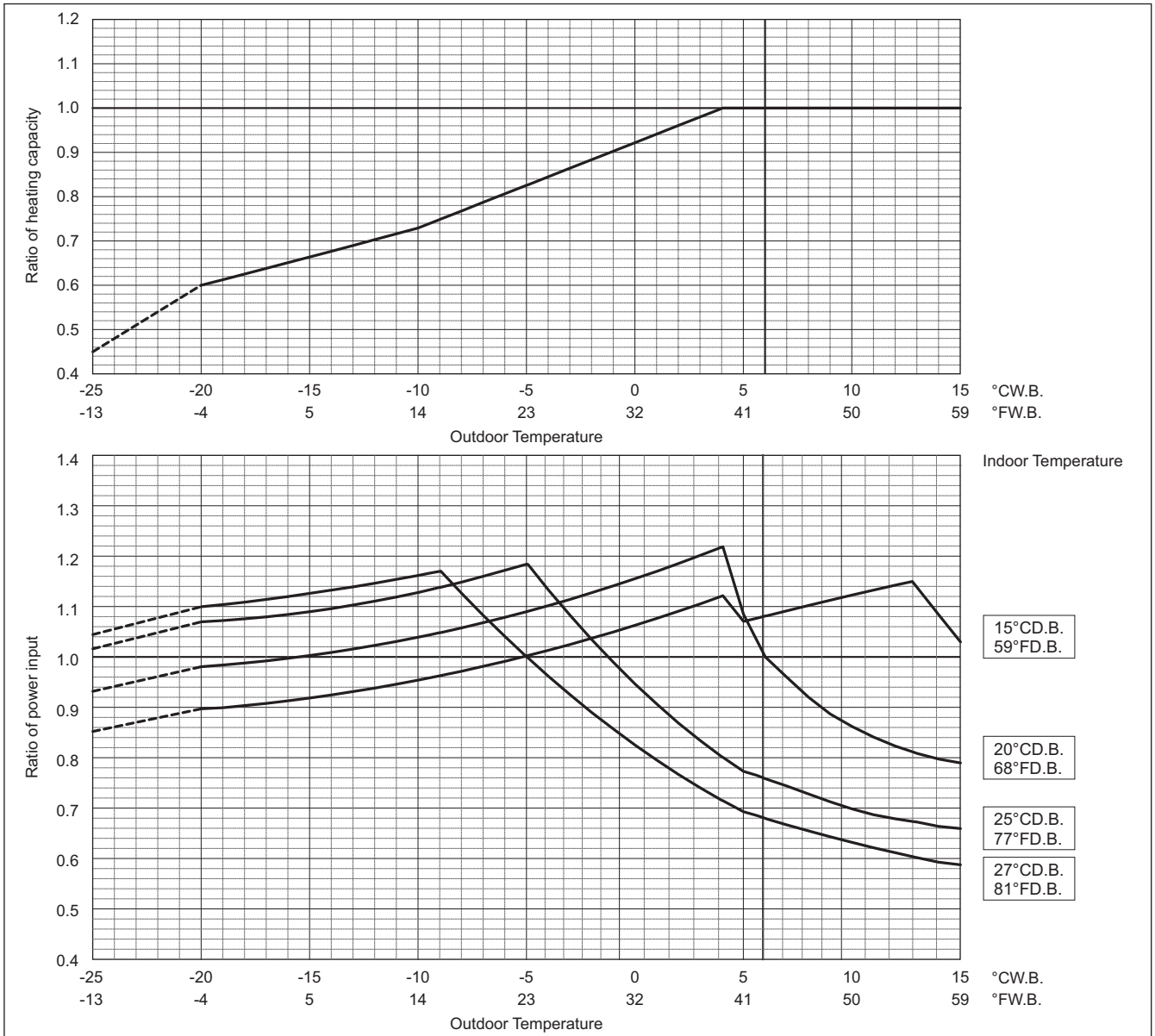

Values in the heating temperature correction diagram in the range below -20°C (-4°F) are reference values and not guaranteed values. Do not use these reference values for selecting outdoor unit models.

When applying product below -20°C (-4°F), consult your design engineer for cold climate application best practices, including the use of a backup source for heating.

8. CAPACITY TABLES

Outdoor units

PURY-		P400YSNW-A	P450YSNW-A	P500YSNW-A
Cooling Capacity	kW	45.0	50.0	56.0
	BTU/h	153,500	170,600	191,100
Input	kW	9.17	10.59	12.29

Indoor unit temperature correction

To be used to correct indoor unit capacity only

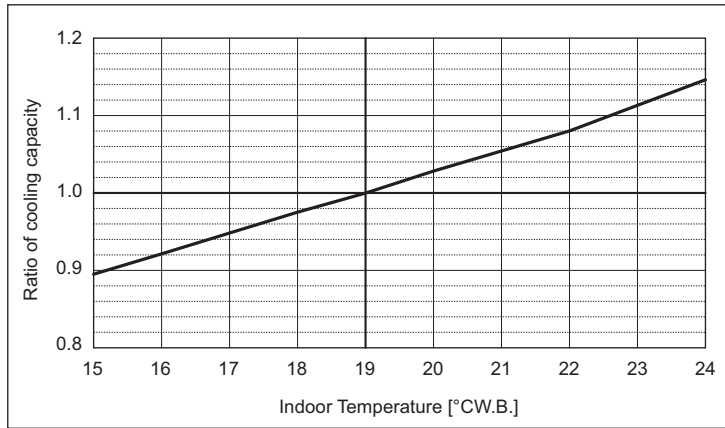

Outdoor unit temperature correction

To be used to correct outdoor unit only

Outdoor unit capacity is NOT affected by the indoor temperature.

Outdoor unit power input is affected by the indoor and outdoor temperatures. Please consult the sales office for details.

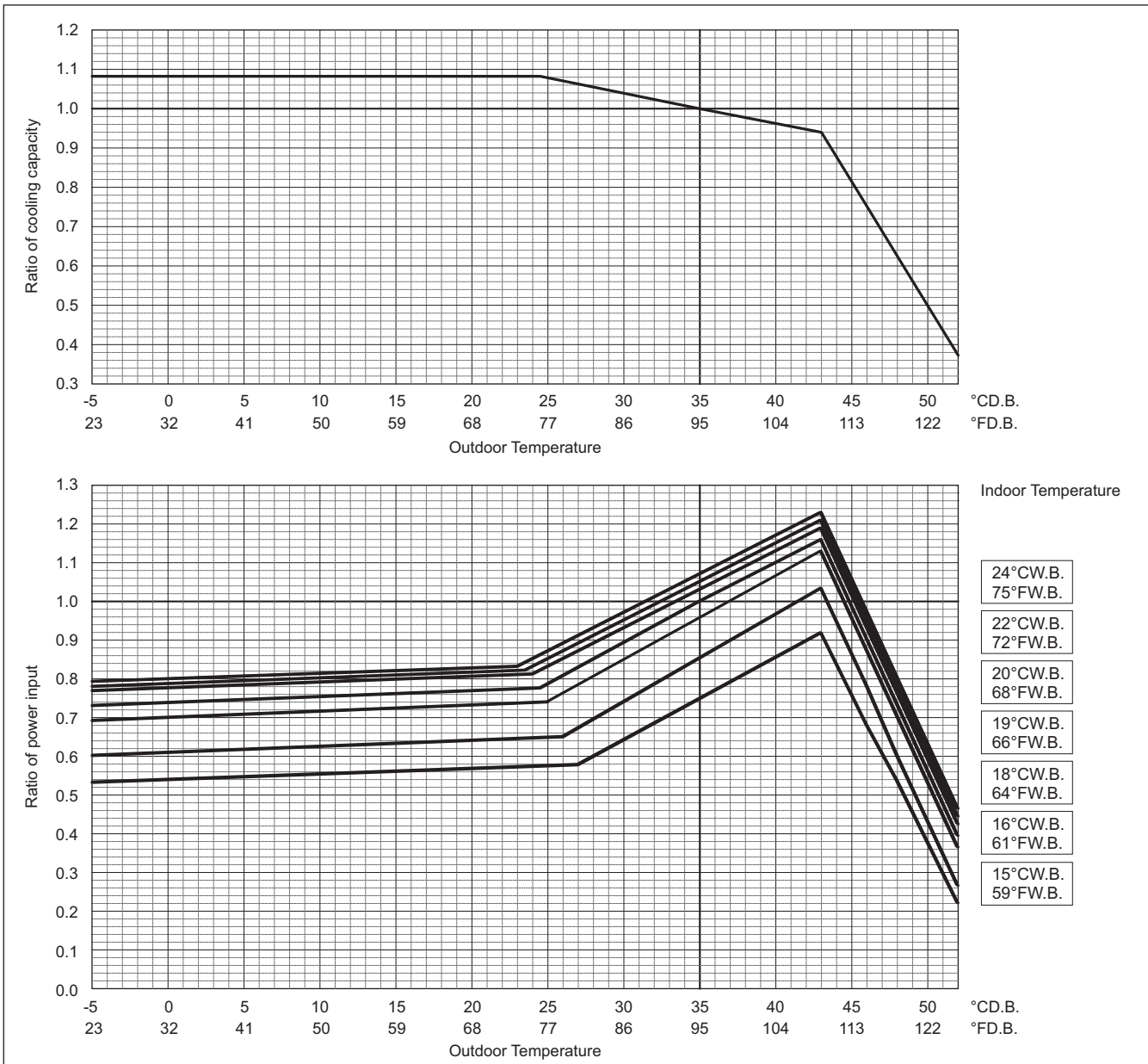

PURY-P-Y(S)NW-A

8. CAPACITY TABLES

	PURY-	P400YSNW-A	P450YSNW-A	P500YSNW-A
Heating Capacity	kW	50.0	56.0	63.0
	BTU/h	170,600	191,100	215,000
Input	kW	9.72	10.99	12.51

Indoor unit temperature correction

To be used to correct indoor unit capacity only

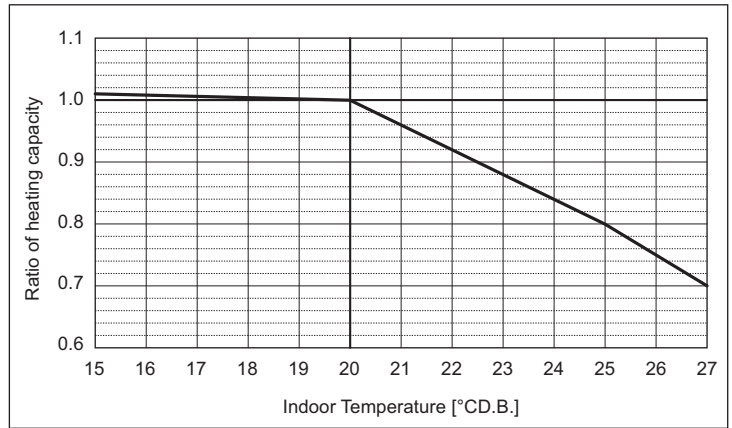

Outdoor unit temperature correction

To be used to correct outdoor unit only

Outdoor unit capacity is NOT affected by the indoor temperature.

Outdoor unit power input is affected by the indoor and outdoor temperatures. Please consult the sales office for details.

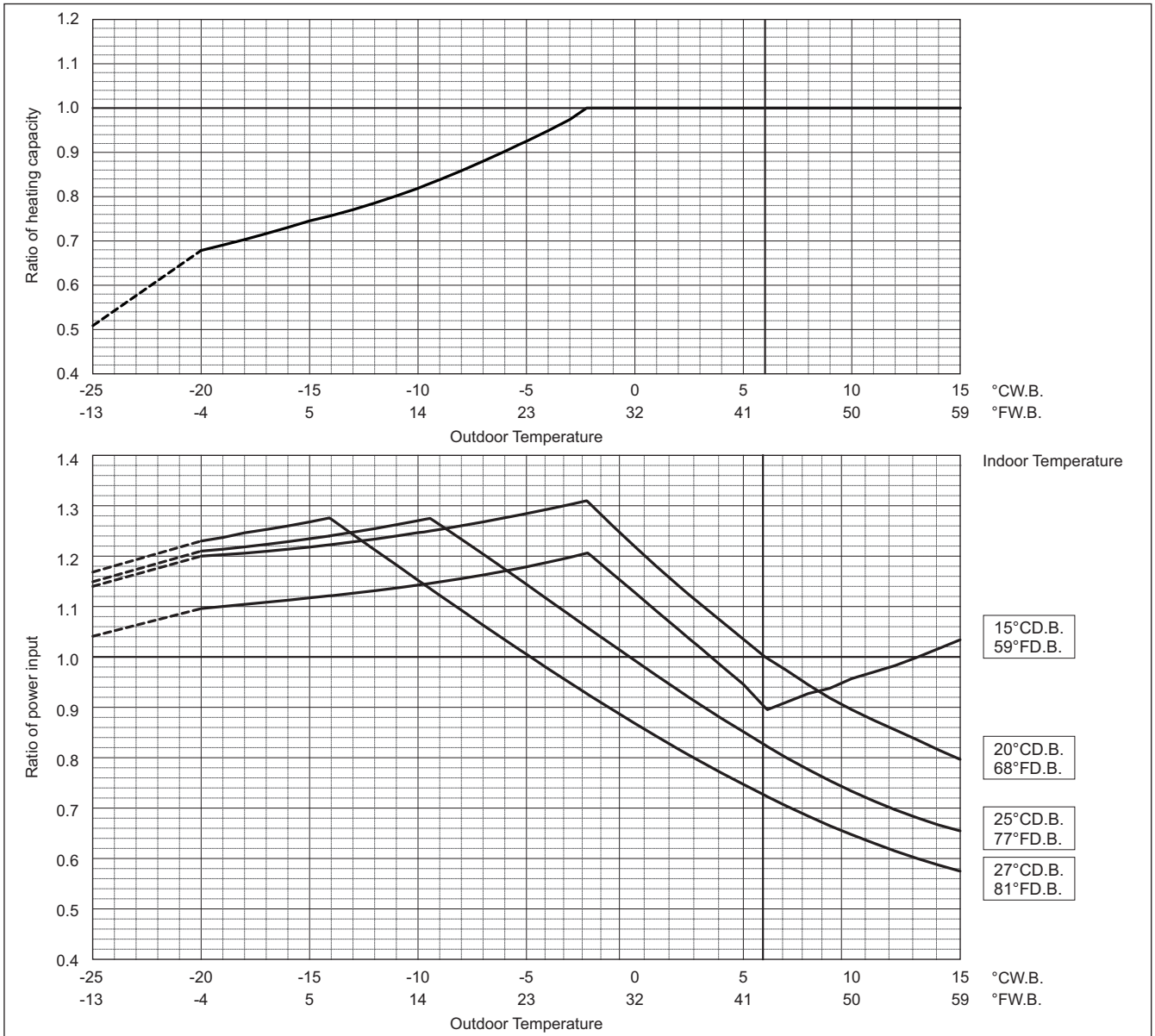

Values in the heating temperature correction diagram in the range below -20°C (-4°F) are reference values and not guaranteed values. Do not use these reference values for selecting outdoor unit models.

When applying product below -20°C (-4°F), consult your design engineer for cold climate application best practices, including the use of a backup source for heating.

8. CAPACITY TABLES

Outdoor units

PURY-		P550YSNW-A	P600YSNW-A	P650YSNW-A
Cooling Capacity	kW	63.0	69.0	73.0
	BTU/h	215,000	235,400	249,100
Input	kW	14.45	16.62	18.19

PURY-		P700YSNW-A
Cooling Capacity	kW	80.0
	BTU/h	273,000
Input	kW	20.72

Indoor unit temperature correction

To be used to correct indoor unit capacity only

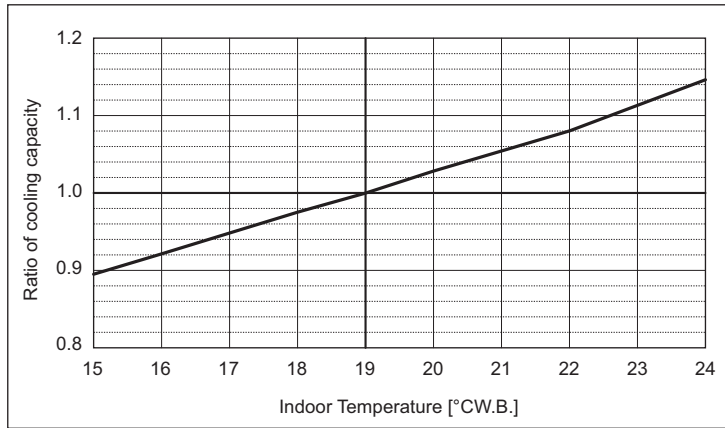

Outdoor unit temperature correction

To be used to correct outdoor unit only

Outdoor unit capacity is NOT affected by the indoor temperature.

Outdoor unit power input is affected by the indoor and outdoor temperatures. Please consult the sales office for details.

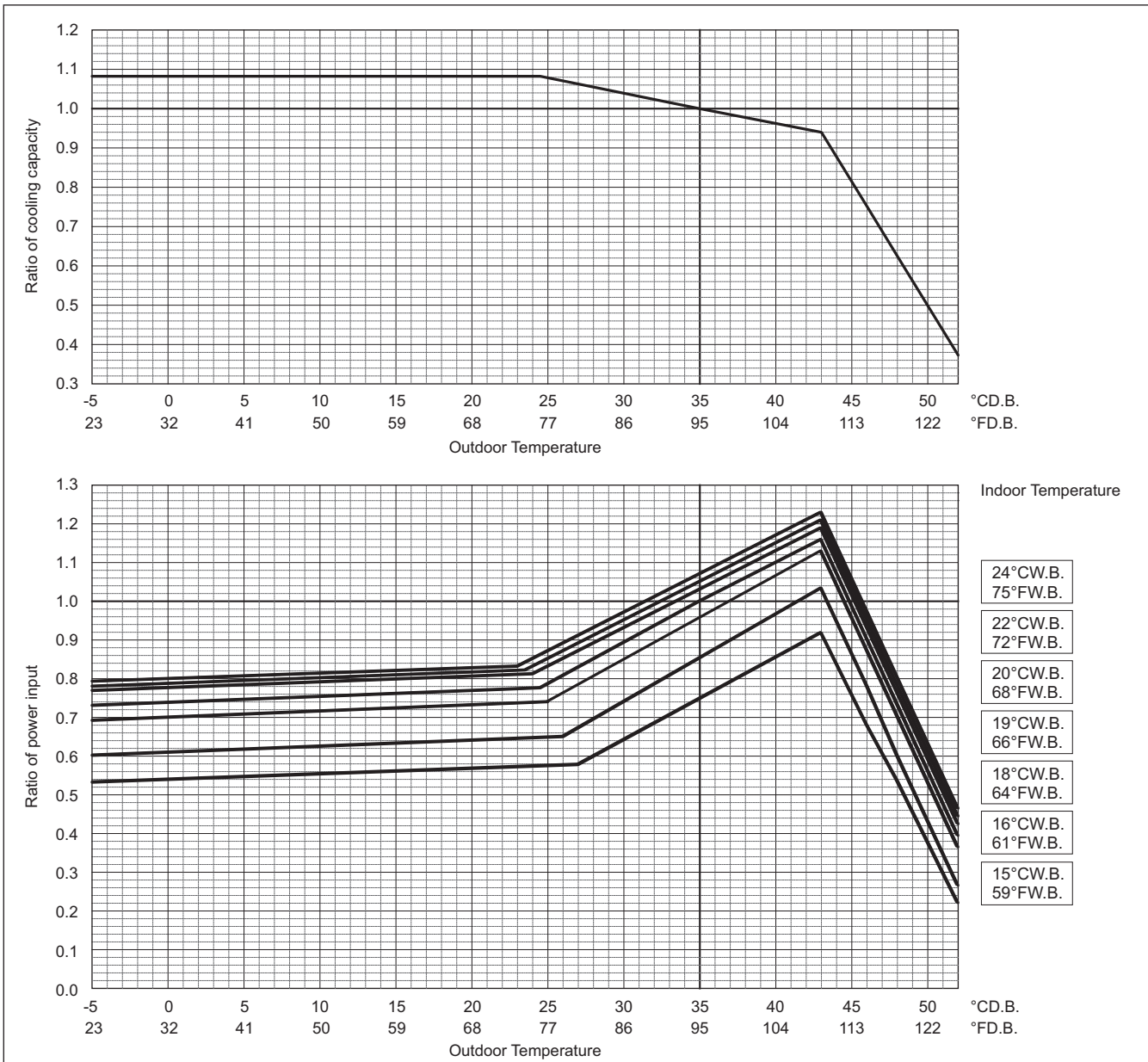

PURY-P-Y(S)NW-A

8. CAPACITY TABLES

PURY-		P550YSNW-A	P600YSNW-A	P650YSNW-A
Heating Capacity	kW	69.0	76.5	81.5
	BTU/h	235,400	261,000	278,100
Input	kW	14.70	17.62	19.35

PURY-		P700YSNW-A
Heating Capacity	kW	88.0
	BTU/h	300,300
Input	kW	21.56

Indoor unit temperature correction
To be used to correct indoor unit capacity only

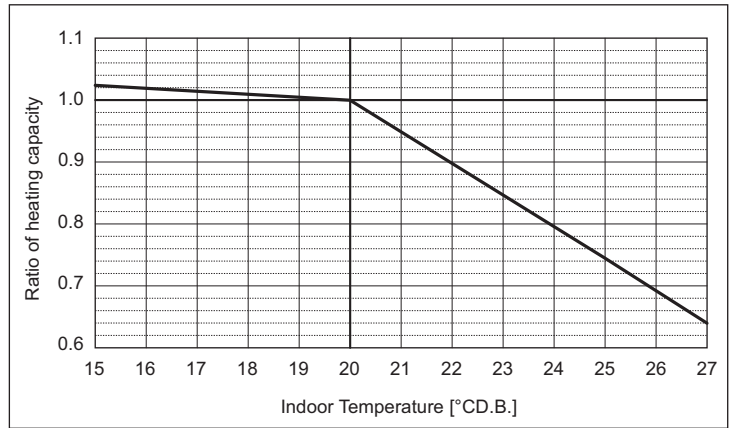

Outdoor unit temperature correction

To be used to correct outdoor unit only
Outdoor unit capacity is NOT affected by the indoor temperature.
Outdoor unit power input is affected by the indoor and outdoor temperatures. Please consult the sales office for details.

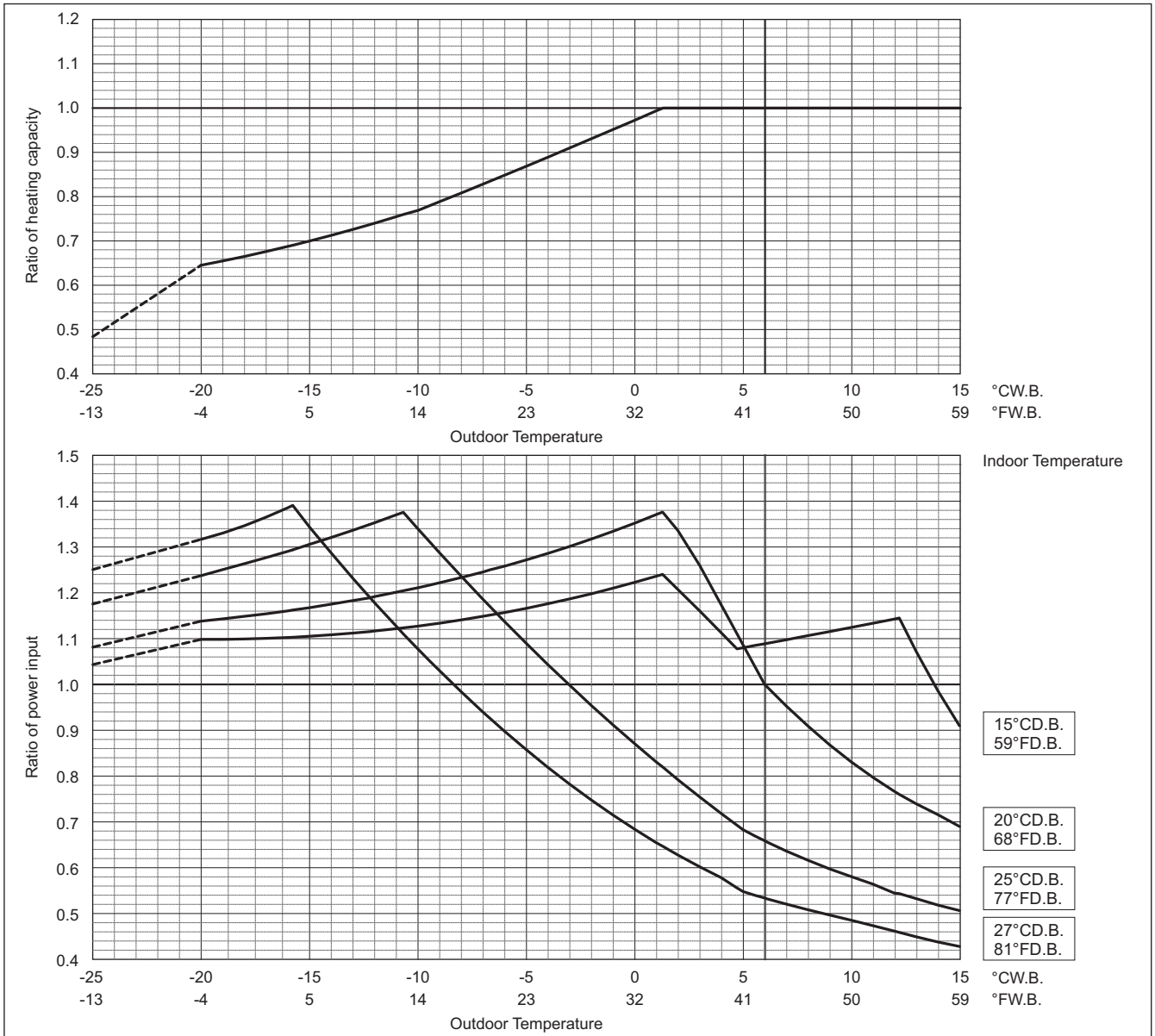

Values in the heating temperature correction diagram in the range below -20°C (-4°F) are reference values and not guaranteed values. Do not use these reference values for selecting outdoor unit models.
When applying product below -20°C (-4°F), consult your design engineer for cold climate application best practices, including the use of a backup source for heating.

PURY-P-Y(S)NW-A

8. CAPACITY TABLES

Outdoor units

PURY-		P750YSNW-A
Cooling Capacity	kW	85.0
	BTU/h	290,000
Input	kW	22.30

Indoor unit temperature correction

To be used to correct indoor unit capacity only

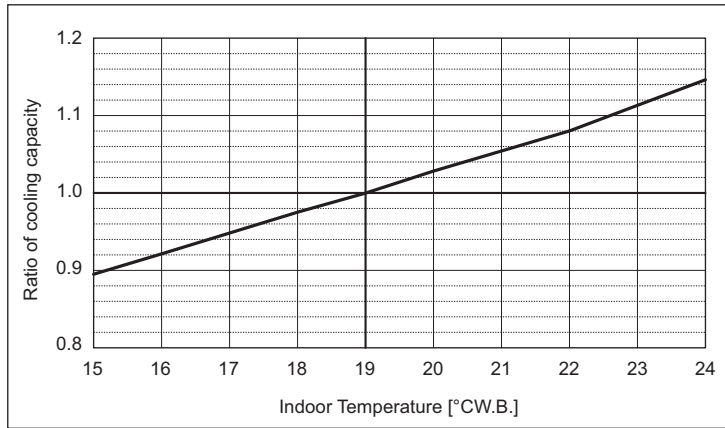

Outdoor unit temperature correction

To be used to correct outdoor unit only

Outdoor unit capacity is NOT affected by the indoor temperature.

Outdoor unit power input is affected by the indoor and outdoor temperatures. Please consult the sales office for details.

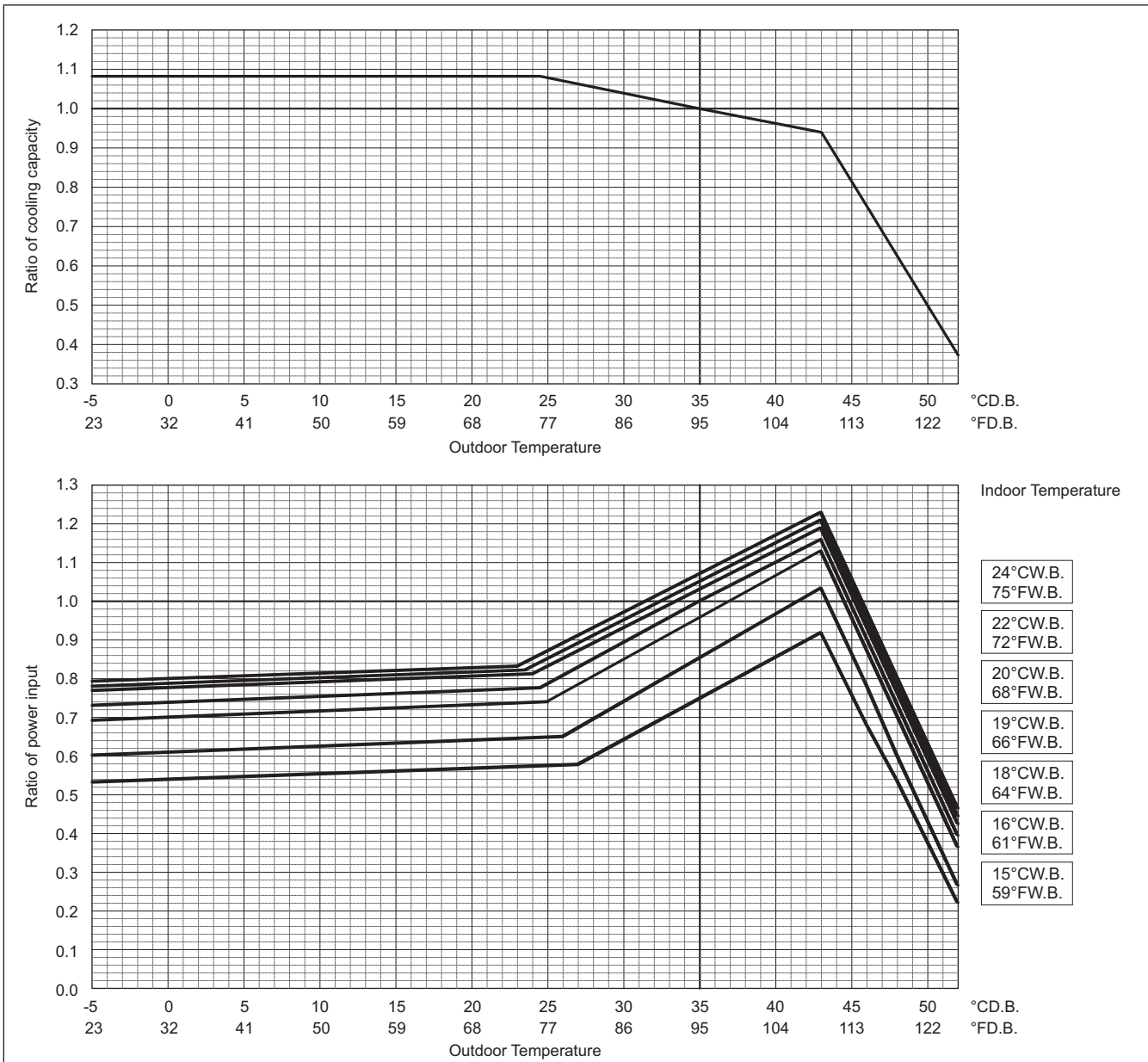

PURY-P-Y(S)NW-A

	PURY-	P750YSNW-A
Heating Capacity	kW	95.0
	BTU/h	324,100
Input	kW	24.86

Indoor unit temperature correction

To be used to correct indoor unit capacity only

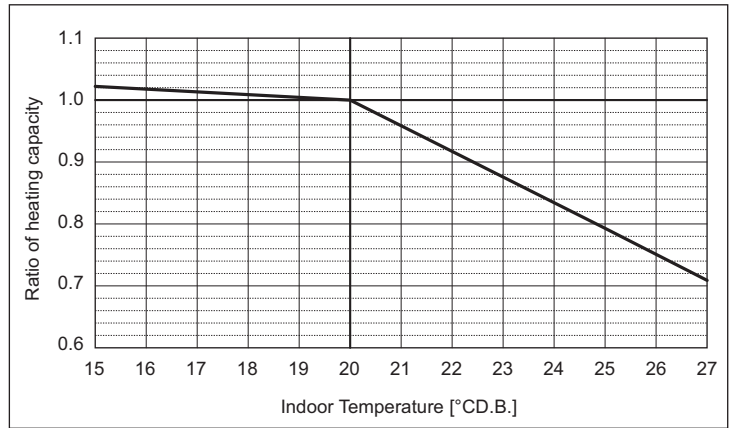

Outdoor unit temperature correction

To be used to correct outdoor unit only

Outdoor unit capacity is NOT affected by the indoor temperature.

Outdoor unit power input is affected by the indoor and outdoor temperatures. Please consult the sales office for details.

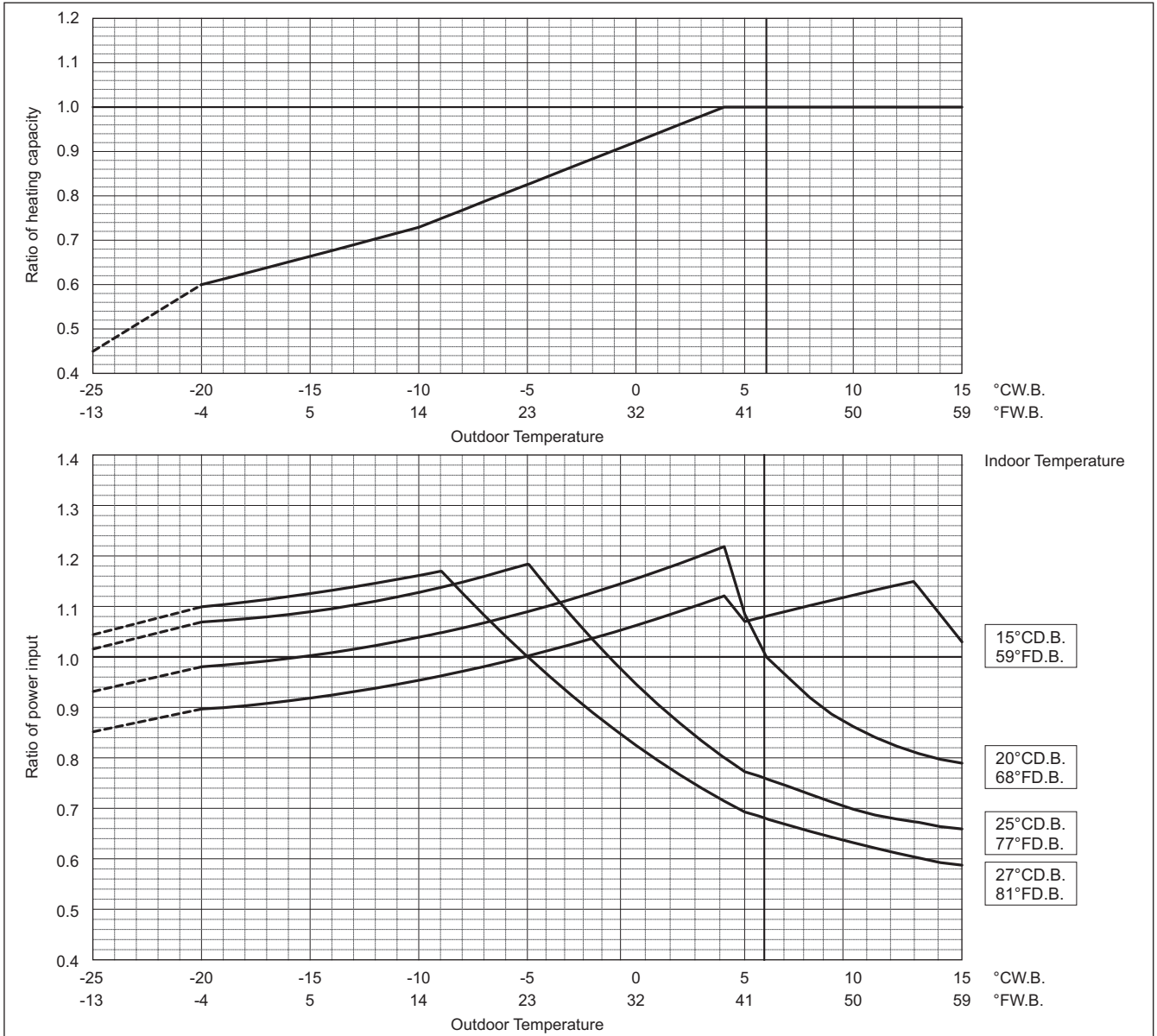

Values in the heating temperature correction diagram in the range below -20°C (-4°F) are reference values and not guaranteed values. Do not use these reference values for selecting outdoor unit models.

When applying product below -20°C (-4°F), consult your design engineer for cold climate application best practices, including the use of a backup source for heating.

8. CAPACITY TABLES

Outdoor units

PURY-		P800YSNW-A	P850YSNW-A	P900YSNW-A
Cooling Capacity	kW	90.0	96.0	101.0
	BTU/h	307,100	327,600	344,600
Input	kW	23.93	24.99	25.76

PURY-		P950YSNW-A	P1000YSNW-A
Cooling Capacity	kW	108.0	113.0
	BTU/h	368,500	385,600
Input	kW	26.40	26.45

Indoor unit temperature correction

To be used to correct indoor unit capacity only

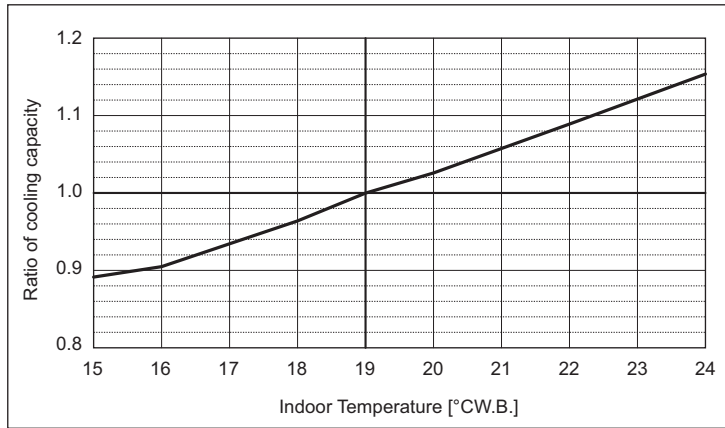

Outdoor unit temperature correction

To be used to correct outdoor unit only
 Outdoor unit capacity is NOT affected by the indoor temperature.
 Outdoor unit power input is affected by the indoor and outdoor temperatures. Please consult the sales office for details.

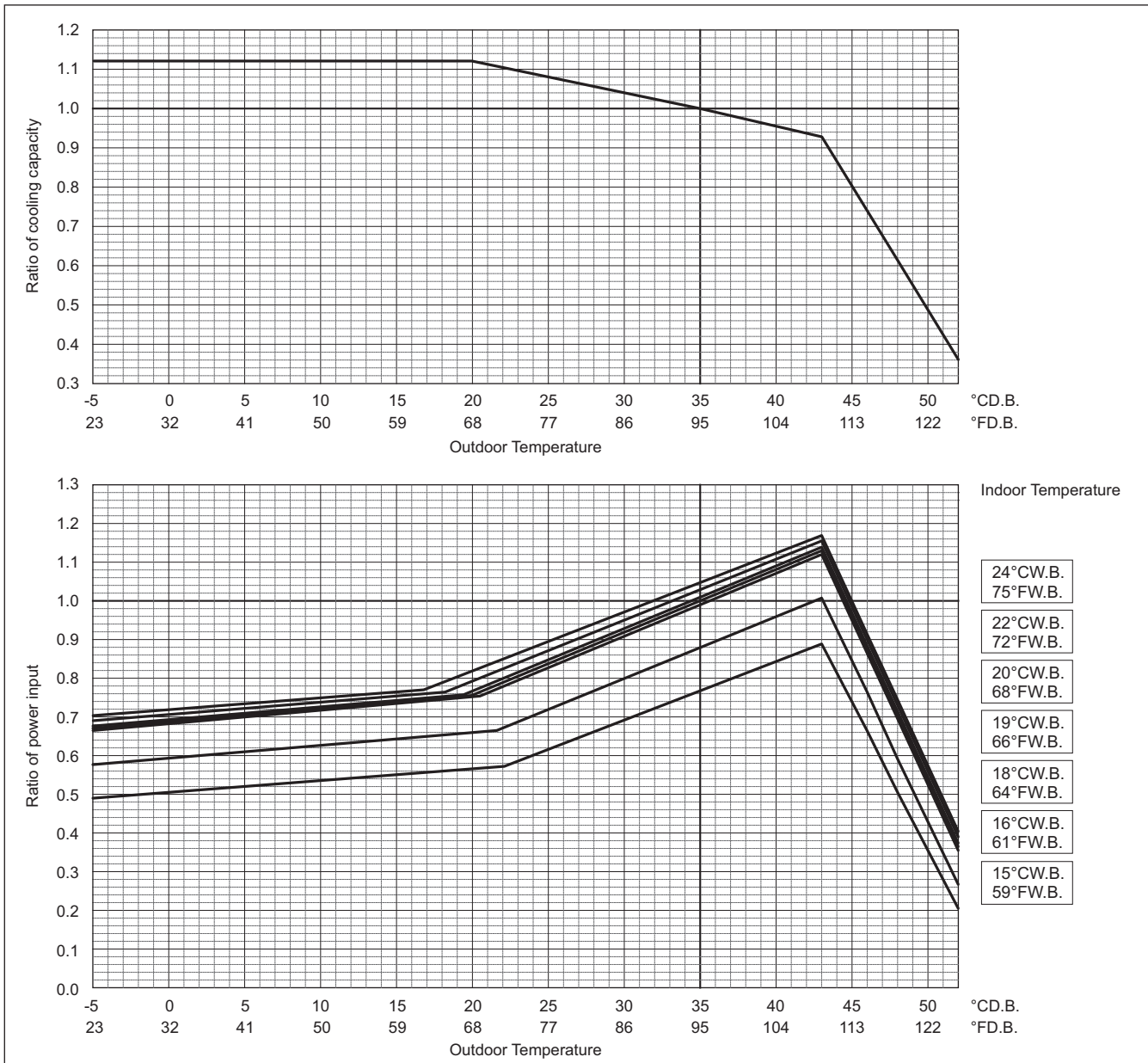

PURY-P-Y(S)NW-A

8. CAPACITY TABLES

PURY-		P800YSNW-A	P850YSNW-A	P900YSNW-A
Heating Capacity	kW	100.0	108.0	113.0
	BTU/h	341,200	368,500	385,600
Input	kW	28.16	28.49	28.03

PURY-		P950YSNW-A	P1000YSNW-A
Heating Capacity	kW	119.5	127.0
	BTU/h	407,700	433,300
Input	kW	29.79	31.74

Indoor unit temperature correction

To be used to correct indoor unit capacity only

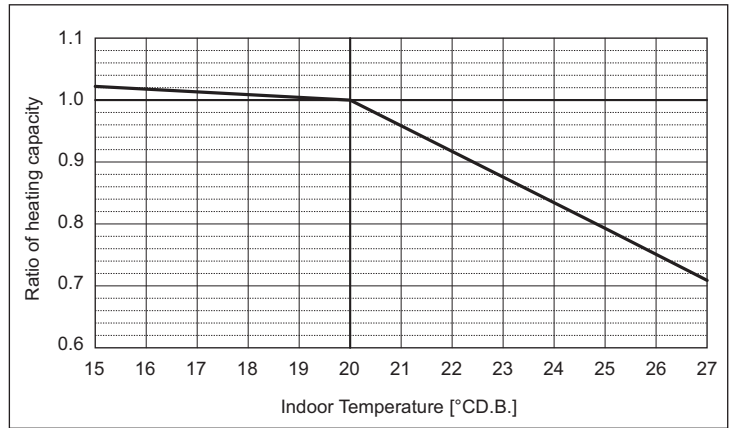

Outdoor unit temperature correction

To be used to correct outdoor unit only
 Outdoor unit capacity is NOT affected by the indoor temperature.
 Outdoor unit power input is affected by the indoor and outdoor temperatures. Please consult the sales office for details.

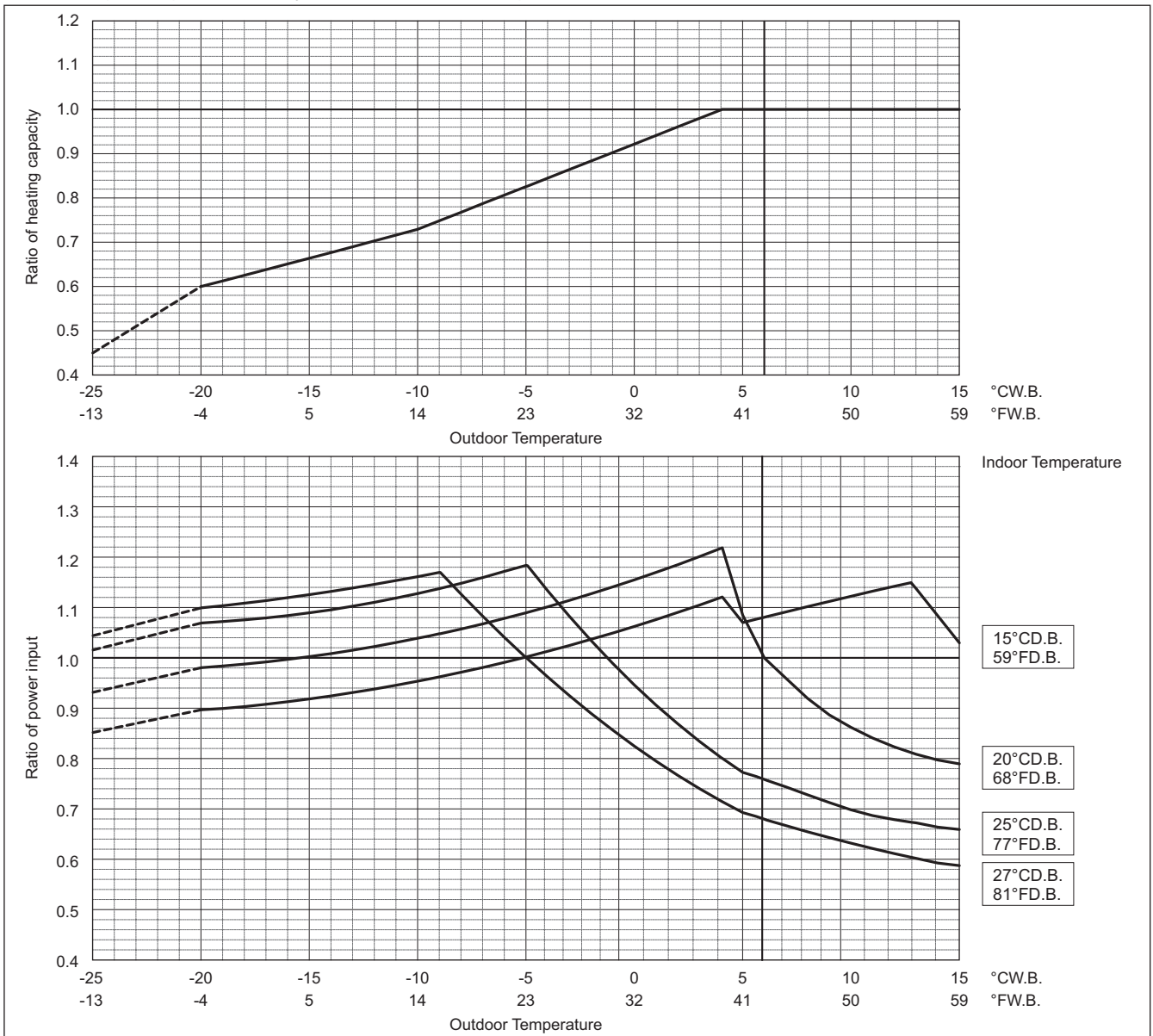

Values in the heating temperature correction diagram in the range below -20°C (-4°F) are reference values and not guaranteed values. Do not use these reference values for selecting outdoor unit models.
 When applying product below -20°C (-4°F), consult your design engineer for cold climate application best practices, including the use of a backup source for heating.

PURY-P-Y(S)NW-A

8. CAPACITY TABLES

Outdoor units

PURY-		P1050YSNW-A	P1100YSNW-A
Cooling Capacity	kW	118.0	124.0
	BTU/h	402,600	423,100
Input	kW	29.20	32.54

Indoor unit temperature correction

To be used to correct indoor unit capacity only

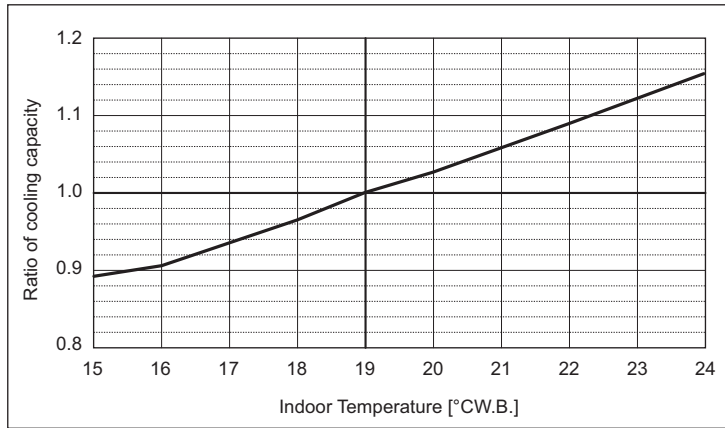

Outdoor unit temperature correction

To be used to correct outdoor unit only

Outdoor unit capacity is NOT affected by the indoor temperature.

Outdoor unit power input is affected by the indoor and outdoor temperatures. Please consult the sales office for details.

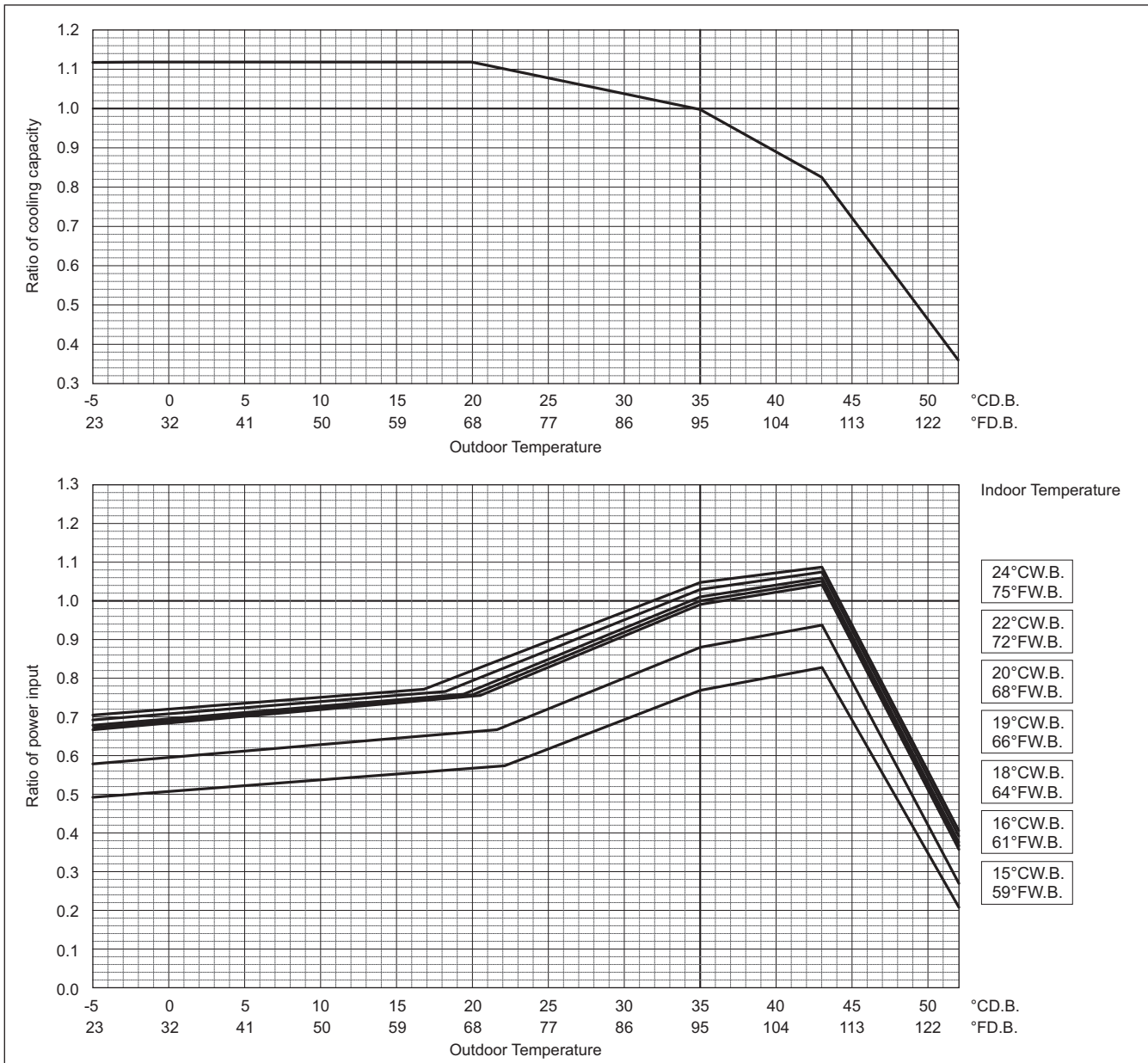

PURY-P-Y(S)NW-A

	PURY-	P1050YSNW-A	P1100YSNW-A
Heating Capacity	kW	132.0	140.0
	BTU/h	450,400	477,700
Input	kW	34.10	37.52

Indoor unit temperature correction

To be used to correct indoor unit capacity only

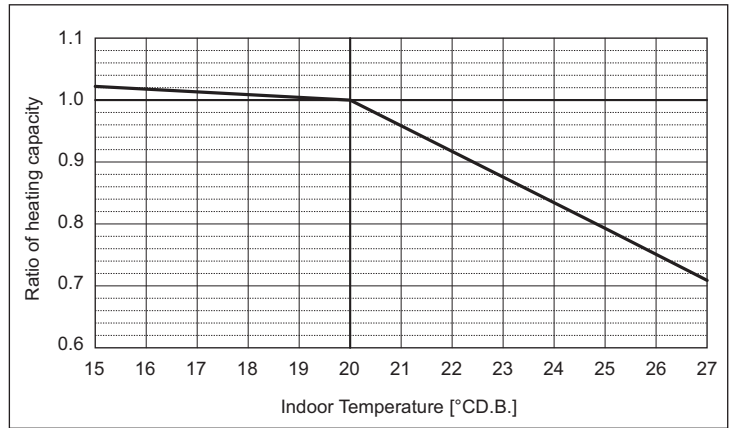

Outdoor unit temperature correction

To be used to correct outdoor unit only

Outdoor unit capacity is NOT affected by the indoor temperature.

Outdoor unit power input is affected by the indoor and outdoor temperatures. Please consult the sales office for details.

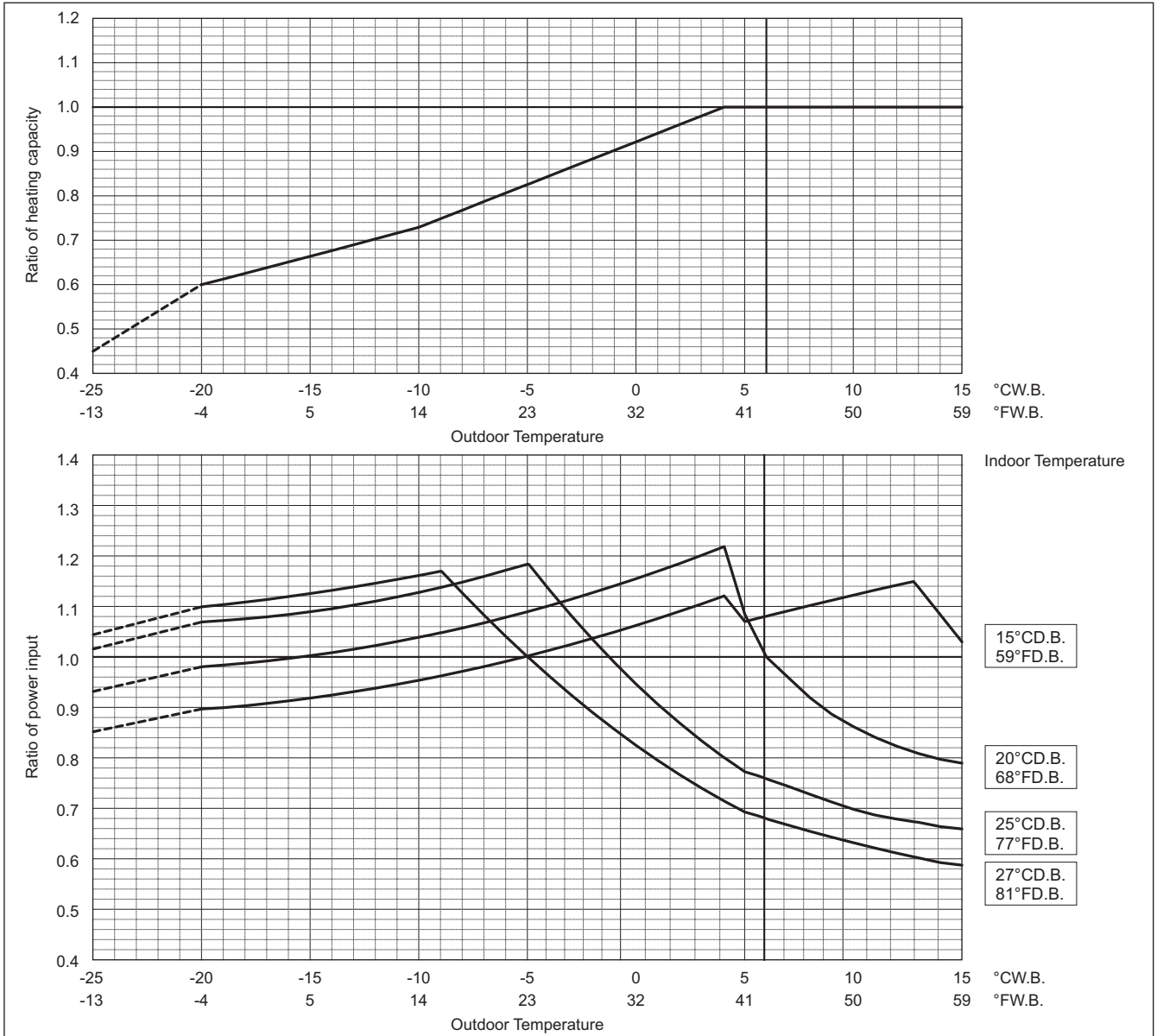

Values in the heating temperature correction diagram in the range below -20°C (-4°F) are reference values and not guaranteed values. Do not use these reference values for selecting outdoor unit models.

When applying product below -20°C (-4°F), consult your design engineer for cold climate application best practices, including the use of a backup source for heating.

PURY-P-Y(S)NW-A

8. CAPACITY TABLES

Outdoor units

Correction by temperature (COP Priority Mode only for heating)

CITY MULTI could have various capacities at different designing temperatures. Using the nominal cooling/heating capacity values and the ratios below, the capacity can be found for various temperatures. To select COP priority mode, SW4 (935) must be set to ON.

	PURY-	P200YNW-A	P250YNW-A
Cooling Capacity	kW	22.4	28.0
	BTU/h	76,400	95,500
Input	kW	4.43	5.97

Indoor unit temperature correction

To be used to correct indoor unit capacity only

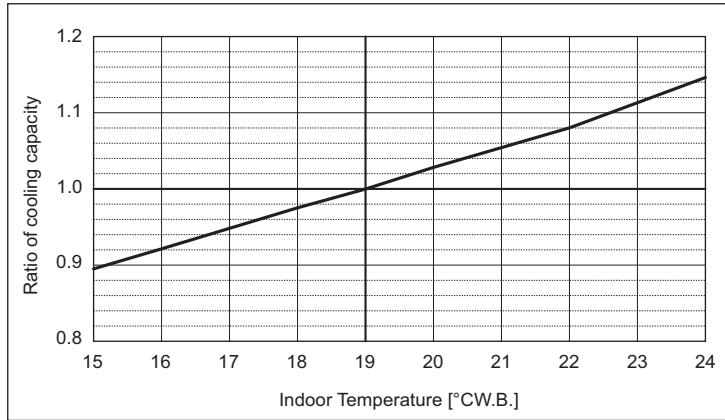

Outdoor unit temperature correction

To be used to correct outdoor unit only

Outdoor unit capacity is NOT affected by the indoor temperature.

Outdoor unit power input is affected by the indoor and outdoor temperatures. Please consult the sales office for details.

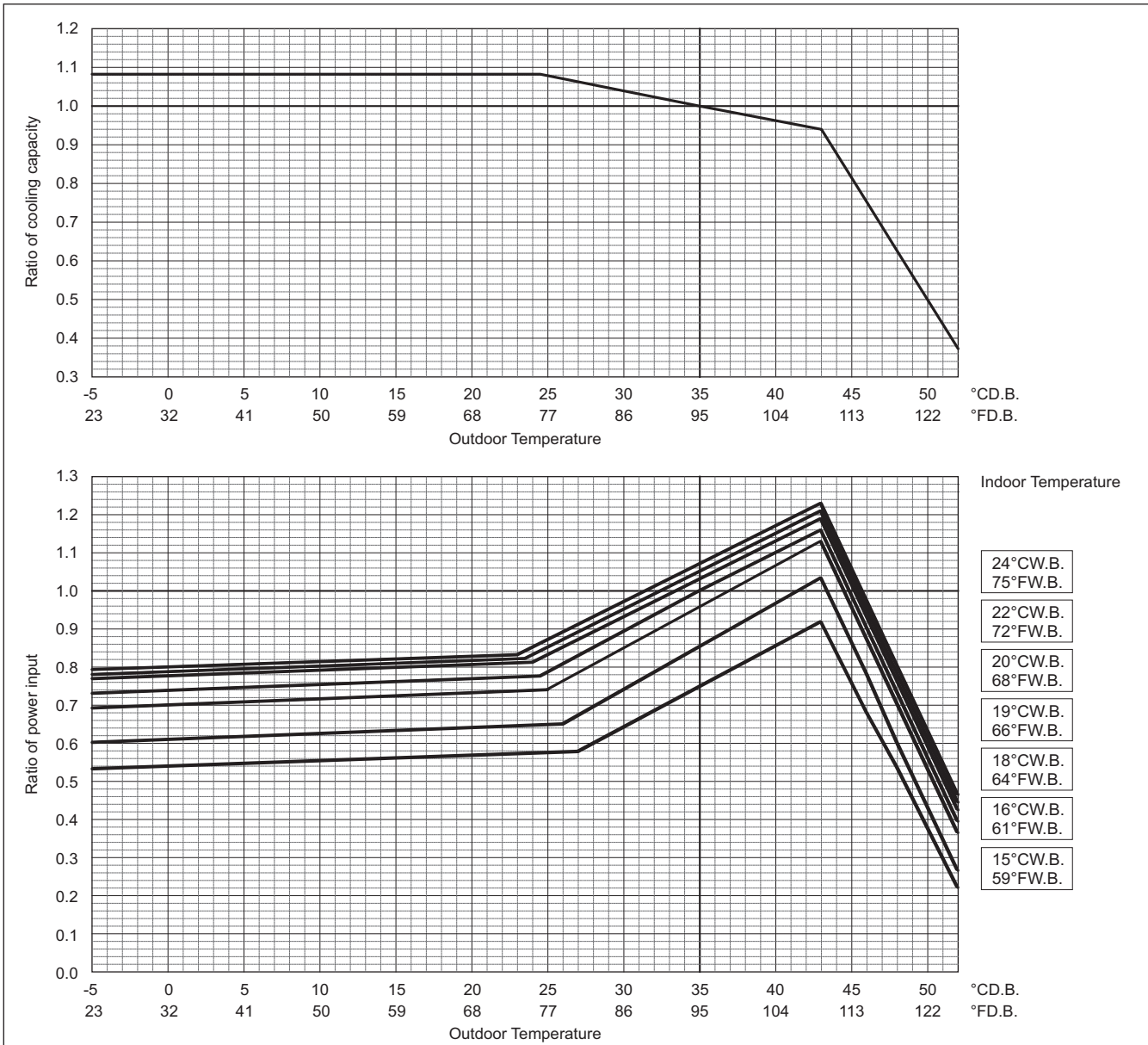

PURY-P-Y(S)NW-A

8. CAPACITY TABLES

COP Priority Mode

	PURY-	P200YNW-A	P250YNW-A
Heating Capacity	kW	25.0	31.5
	BTU/h	85,300	107,500
Input	kW	4.71	6.06

Indoor unit temperature correction

To be used to correct indoor unit capacity only

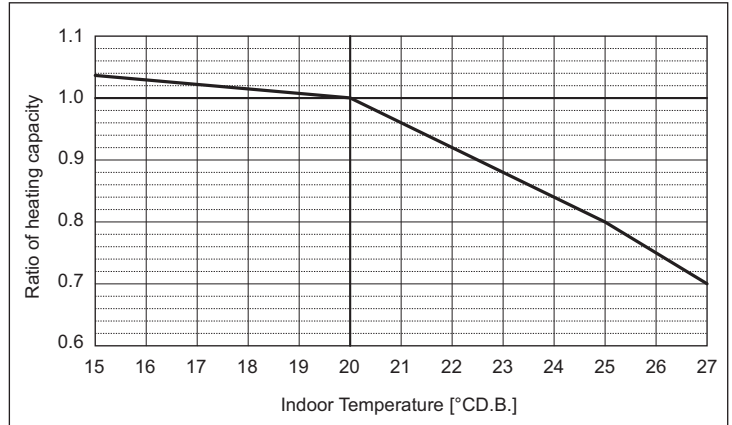

Outdoor unit temperature correction

To be used to correct outdoor unit only

Outdoor unit capacity is NOT affected by the indoor temperature.

Outdoor unit power input is affected by the indoor and outdoor temperatures. Please consult the sales office for details.

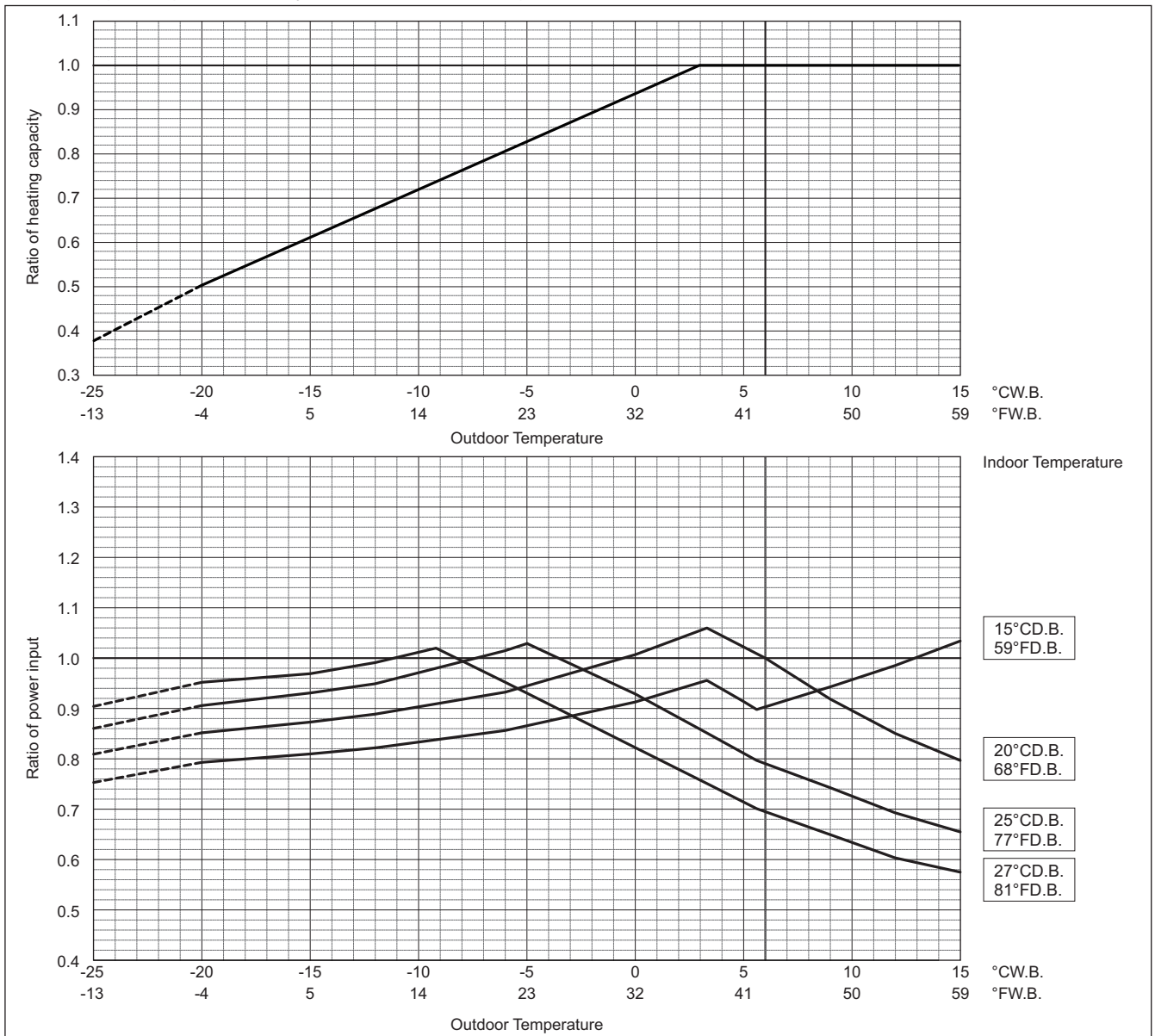

Values in the heating temperature correction diagram in the range below -20°C (-4°F) are reference values and not guaranteed values. Do not use these reference values for selecting outdoor unit models.

When applying product below -20°C (-4°F), consult your design engineer for cold climate application best practices, including the use of a backup source for heating.

PURY-P-Y(S)NW-A

8. CAPACITY TABLES

Outdoor units

PURY-		P300YNW-A	P350YNW-A
Cooling Capacity	kW	33.5	40.0
	BTU/h	114,300	136,500
Input	kW	7.54	10.04

Indoor unit temperature correction

To be used to correct indoor unit capacity only

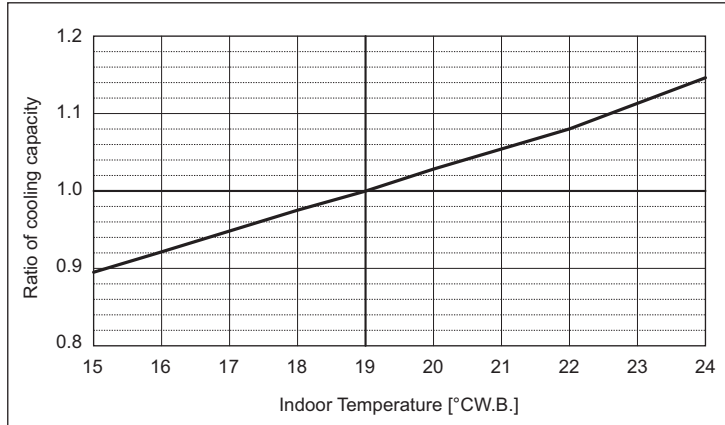

Outdoor unit temperature correction

To be used to correct outdoor unit only

Outdoor unit capacity is NOT affected by the indoor temperature.

Outdoor unit power input is affected by the indoor and outdoor temperatures. Please consult the sales office for details.

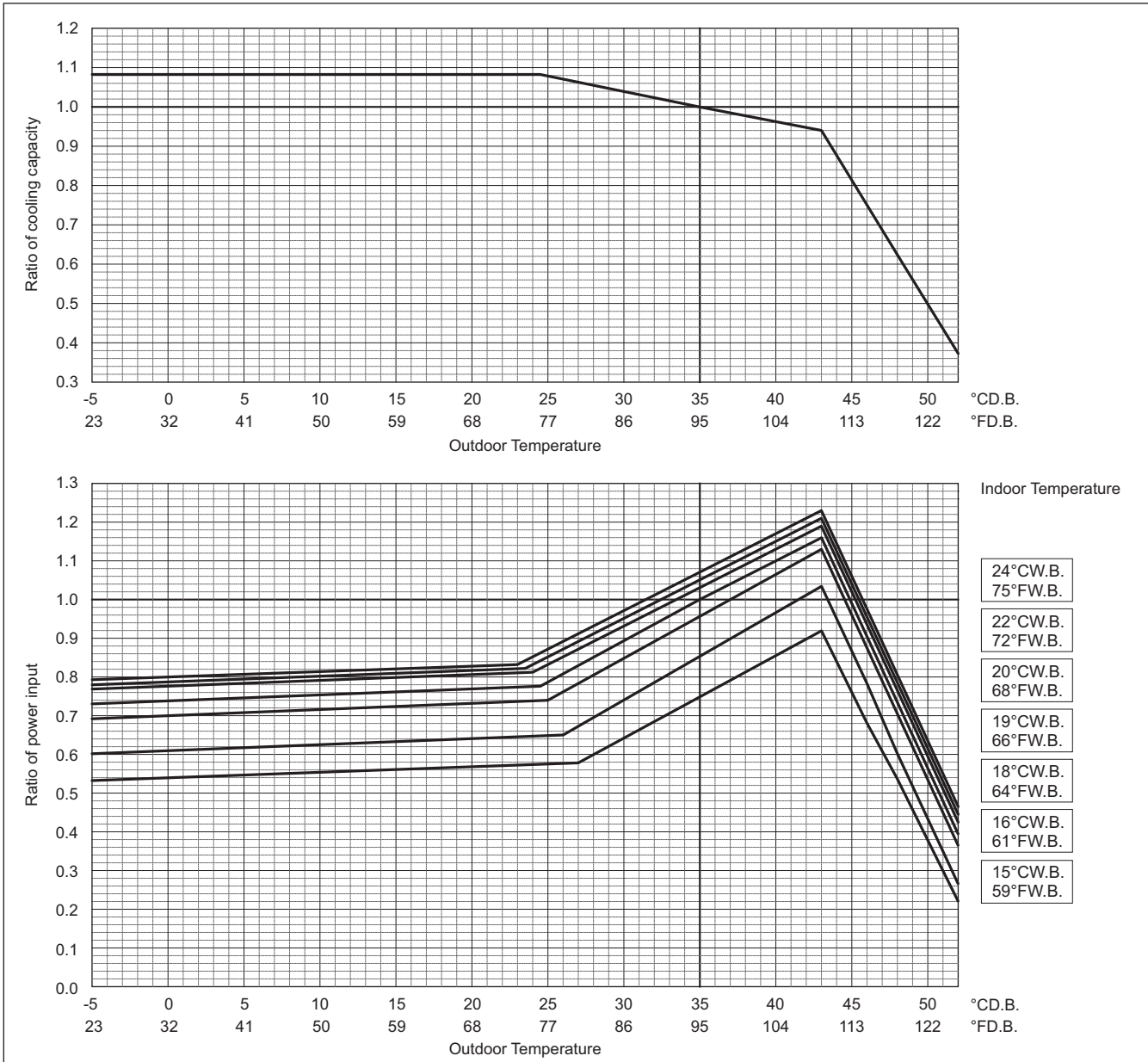

PURY-P-Y(S)NW-A

8. CAPACITY TABLES

COP Priority Mode

	PURY-	P300YNW-A	P350YNW-A
Heating Capacity	kW	37.5	45.0
	BTU/h	128,000	153,500
Input	kW	8.38	10.68

Indoor unit temperature correction

To be used to correct indoor unit capacity only

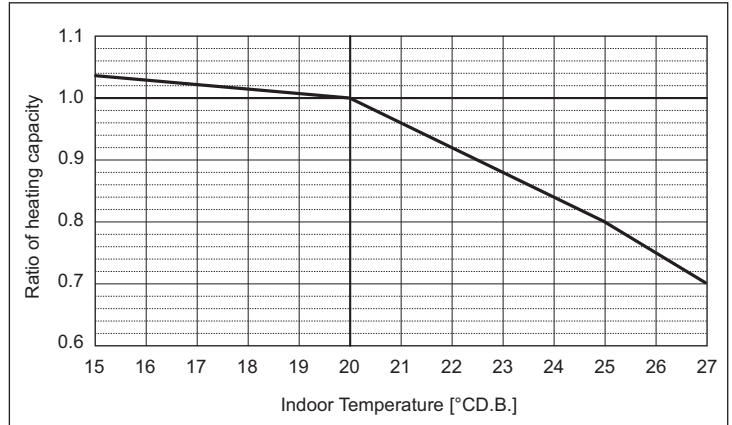

Outdoor unit temperature correction

To be used to correct outdoor unit only

Outdoor unit capacity is NOT affected by the indoor temperature.

Outdoor unit power input is affected by the indoor and outdoor temperatures. Please consult the sales office for details.

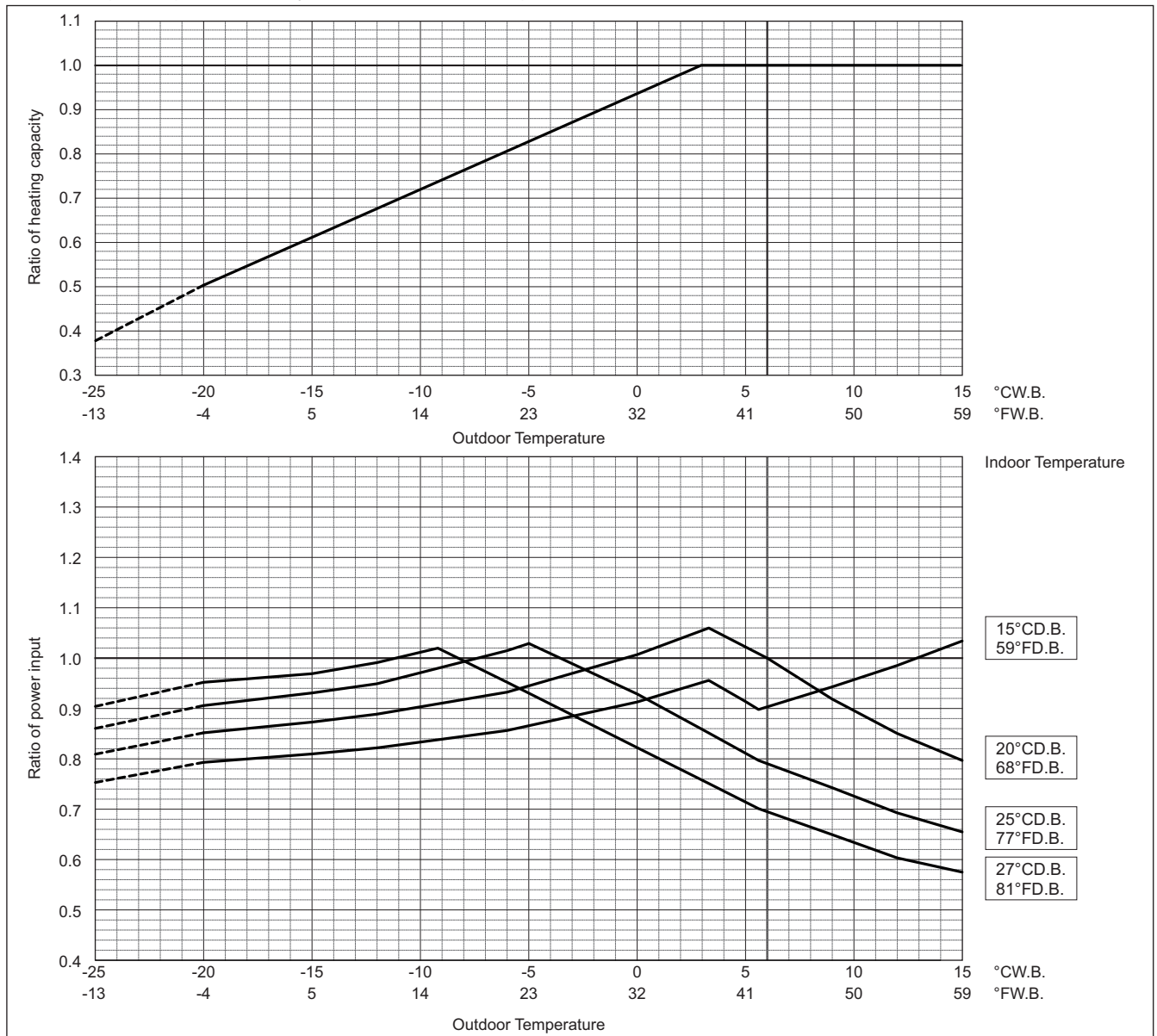

Values in the heating temperature correction diagram in the range below -20°C (-4°F) are reference values and not guaranteed values. Do not use these reference values for selecting outdoor unit models.

When applying product below -20°C (-4°F), consult your design engineer for cold climate application best practices, including the use of a backup source for heating.

PURY-P-Y(S)NW-A

8. CAPACITY TABLES

Outdoor units

PURY-		P400YNW-A	P450YNW-A	P500YNW-A
Cooling Capacity	kW	45.0	50.0	56.0
	BTU/h	153,500	170,600	191,100
Input	kW	11.59	12.37	12.72

Indoor unit temperature correction

To be used to correct indoor unit capacity only

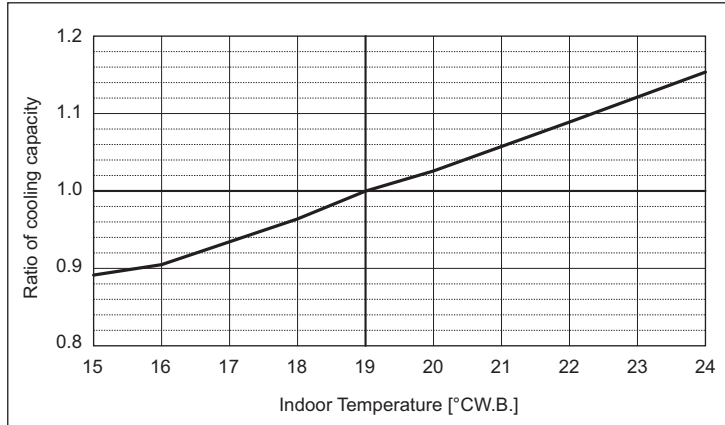

Outdoor unit temperature correction

To be used to correct outdoor unit only

Outdoor unit capacity is NOT affected by the indoor temperature.

Outdoor unit power input is affected by the indoor and outdoor temperatures. Please consult the sales office for details.

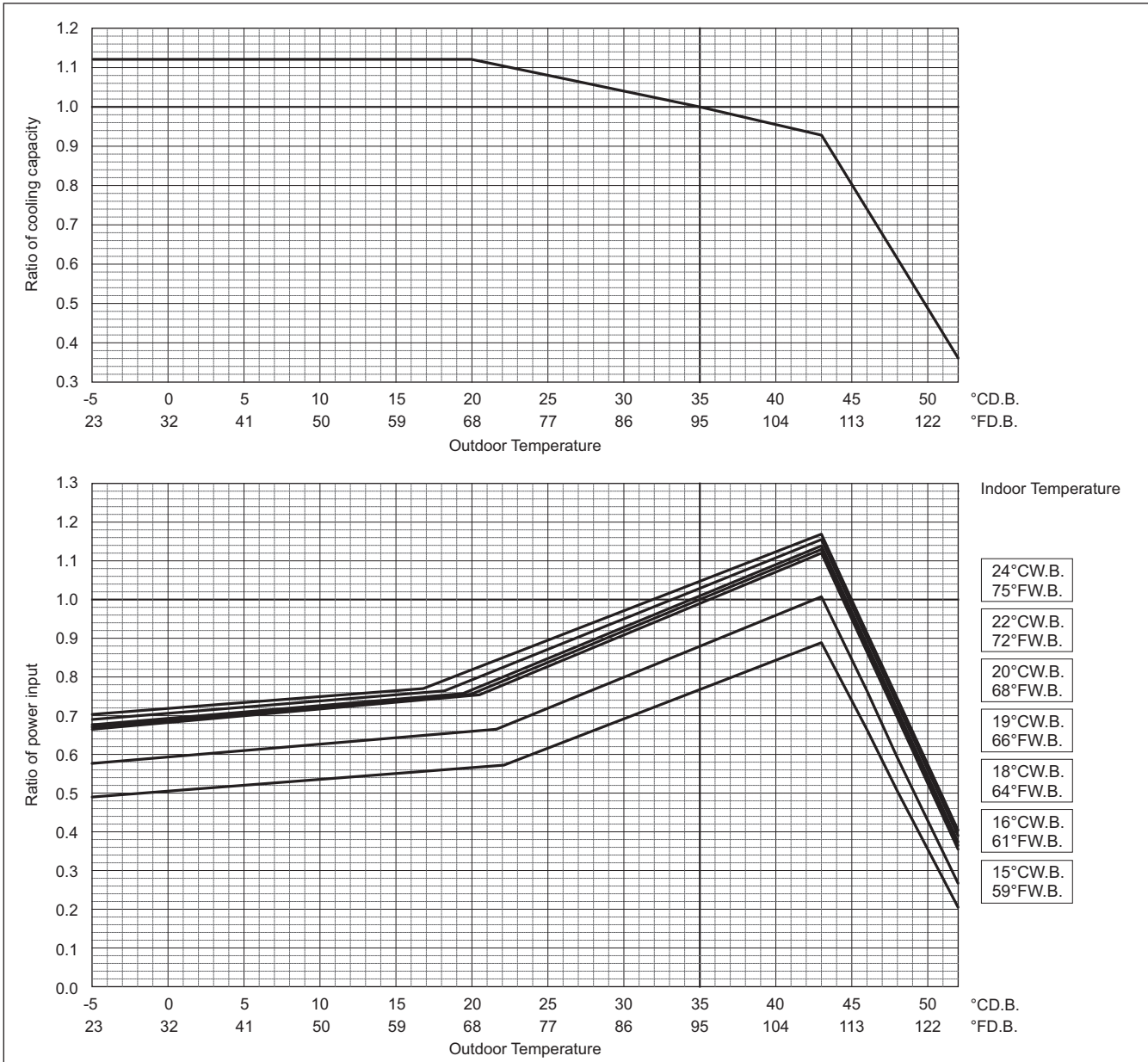

PURY-P-Y(S)NW-A

8. CAPACITY TABLES

Outdoor units

COP Priority Mode

	PURY-	P400YNW-A	P450YNW-A	P500YNW-A
Heating Capacity	kW	50.0	56.0	63.0
	BTU/h	170,600	191,100	215,000
Input	kW	13.65	13.48	15.28

Indoor unit temperature correction

To be used to correct indoor unit capacity only

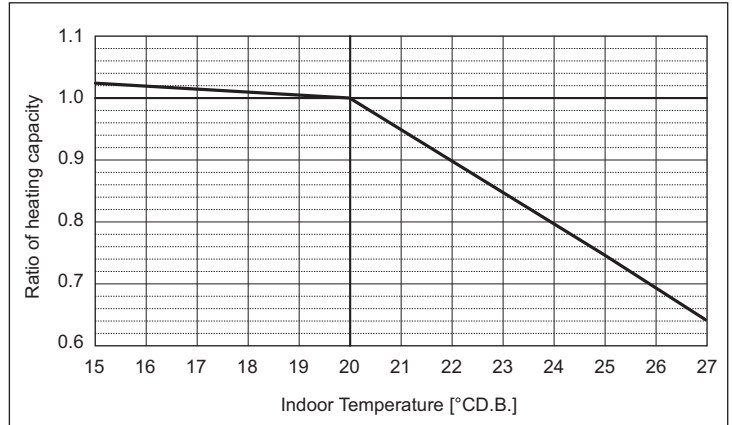

Outdoor unit temperature correction

To be used to correct outdoor unit only

Outdoor unit capacity is NOT affected by the indoor temperature.

Outdoor unit power input is affected by the indoor and outdoor temperatures. Please consult the sales office for details.

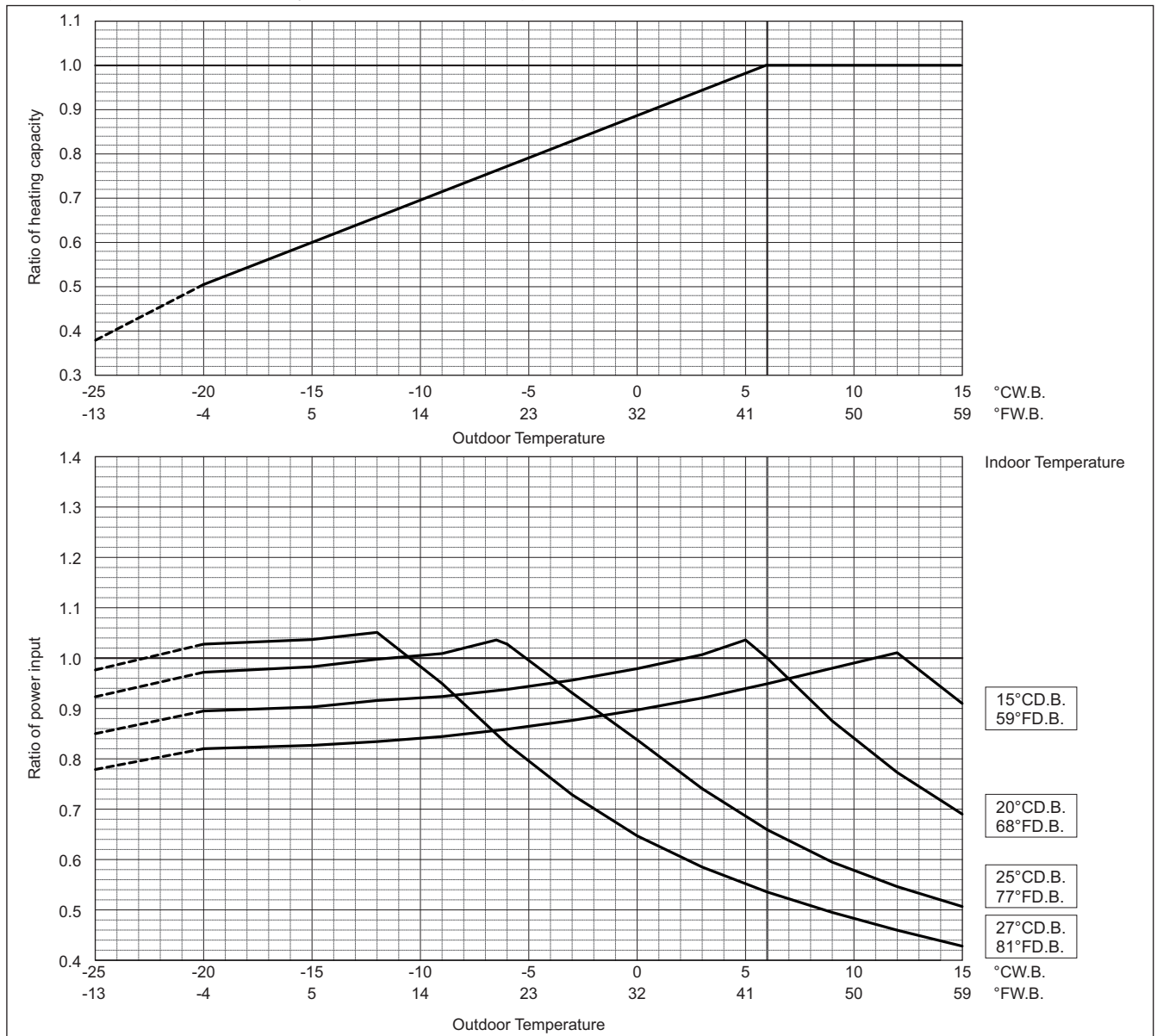

Values in the heating temperature correction diagram in the range below -20°C (-4°F) are reference values and not guaranteed values. Do not use these reference values for selecting outdoor unit models.

When applying product below -20°C (-4°F), consult your design engineer for cold climate application best practices, including the use of a backup source for heating.

PURY-P-Y(S)NW-A

8. CAPACITY TABLES

Outdoor units

PURY-		P550YNW-A
Cooling Capacity	kW	63.0
	BTU/h	215,000
Input	kW	16.03

Indoor unit temperature correction

To be used to correct indoor unit capacity only

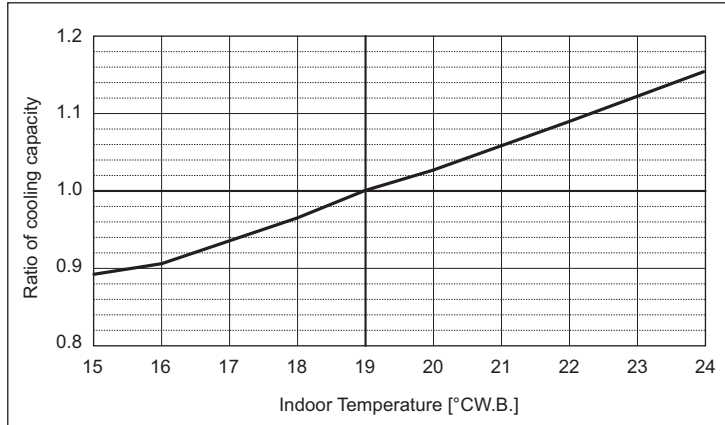

Outdoor unit temperature correction

To be used to correct outdoor unit only

Outdoor unit capacity is NOT affected by the indoor temperature.

Outdoor unit power input is affected by the indoor and outdoor temperatures. Please consult the sales office for details.

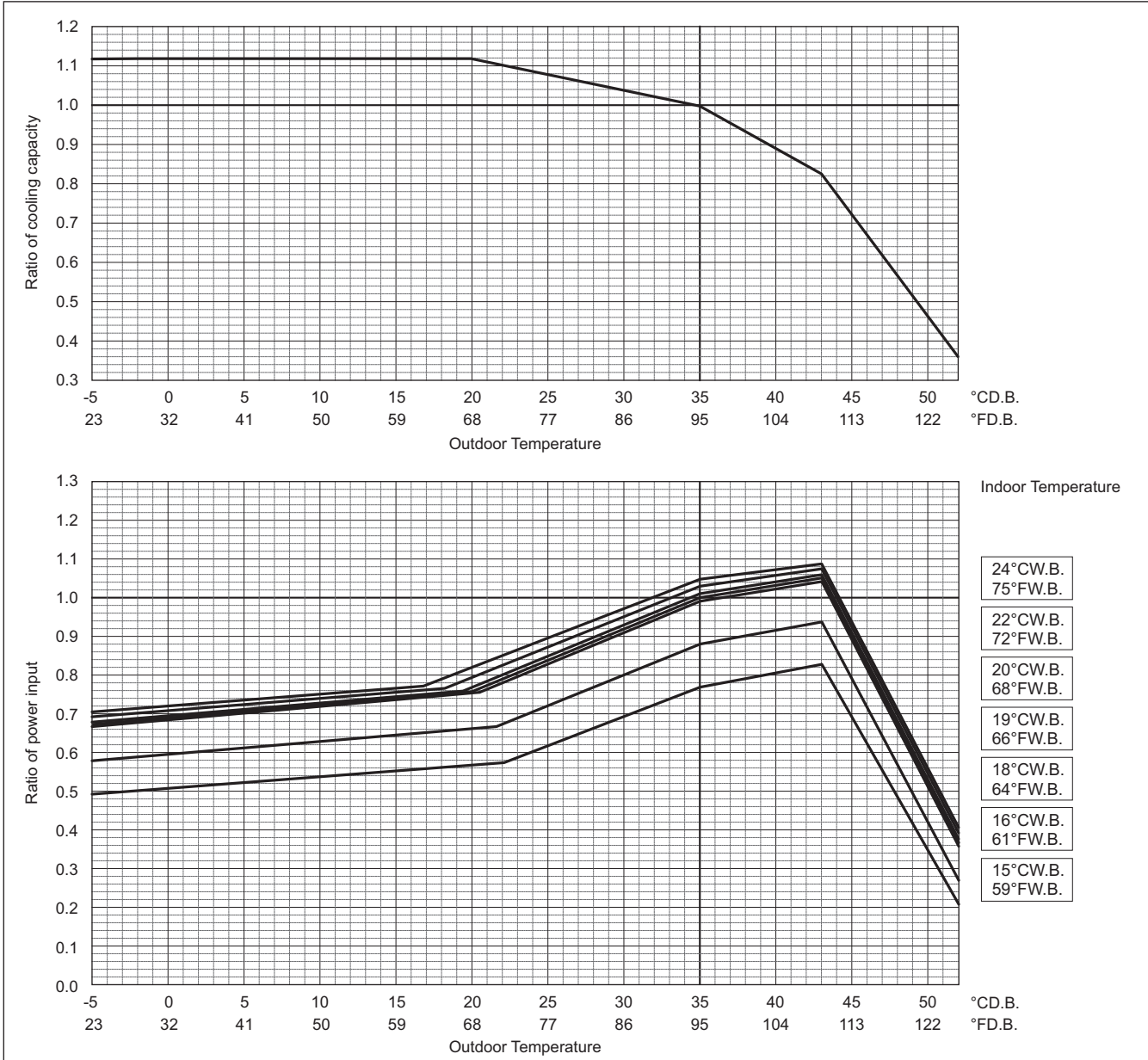

PURY-P-Y(S)NW-A

8. CAPACITY TABLES

COP Priority Mode

	PURY-	P550YNW-A
Heating Capacity	kW	69.0
	BTU/h	235,400
Input	kW	17.91

Indoor unit temperature correction

To be used to correct indoor unit capacity only

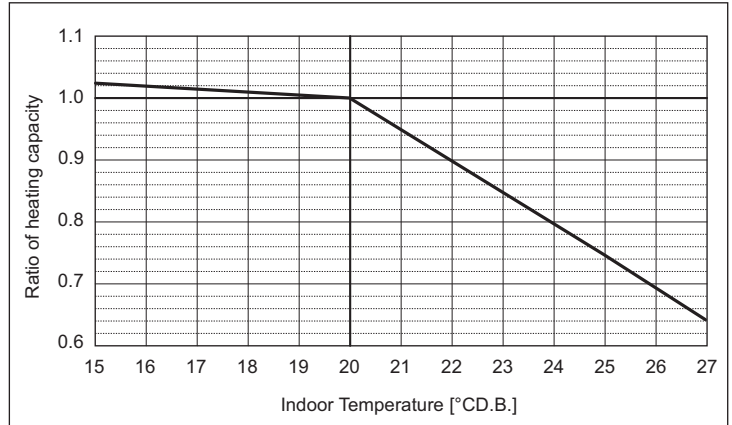

Outdoor unit temperature correction

To be used to correct outdoor unit only

Outdoor unit capacity is NOT affected by the indoor temperature.

Outdoor unit power input is affected by the indoor and outdoor temperatures. Please consult the sales office for details.

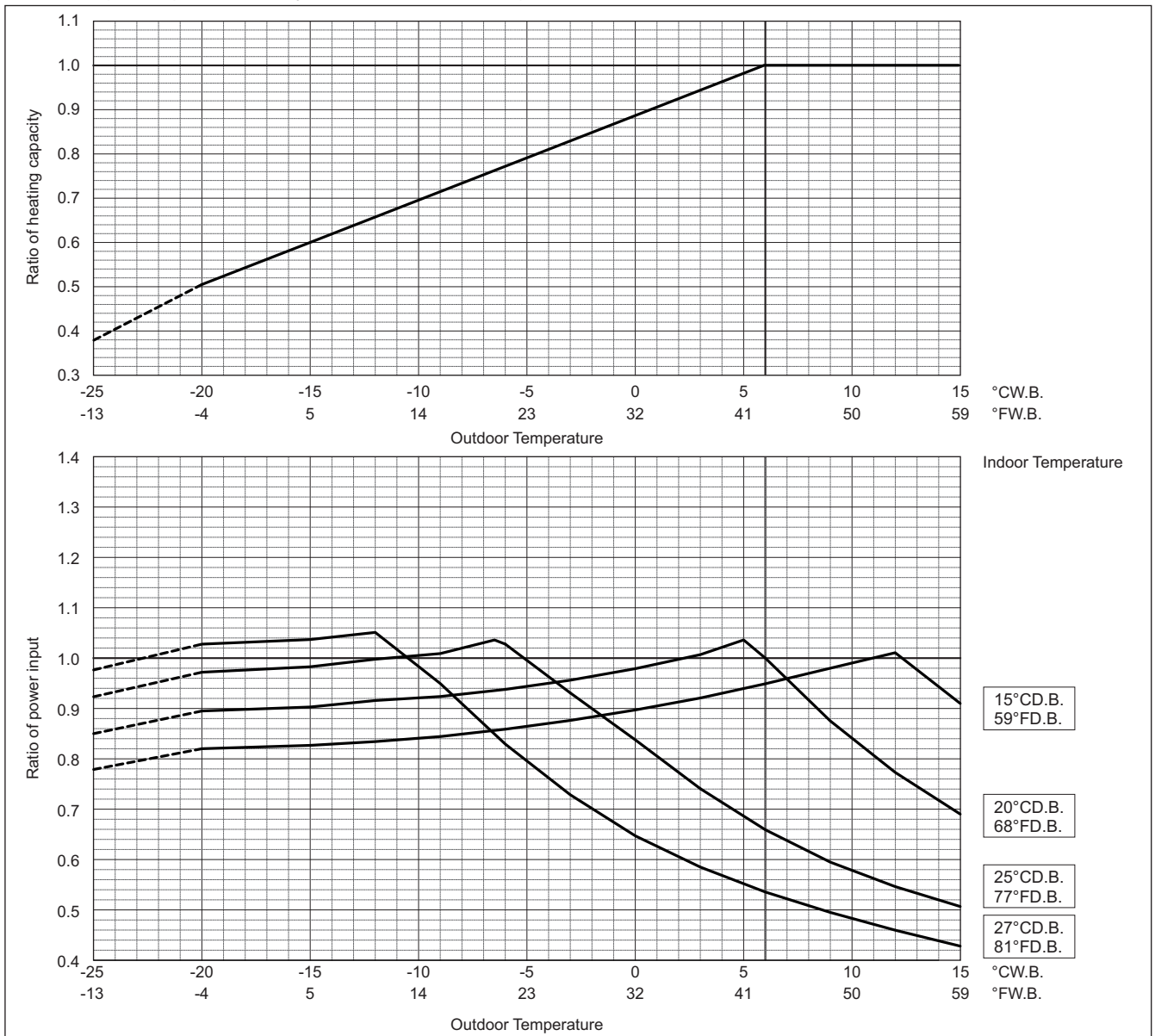

Values in the heating temperature correction diagram in the range below -20°C (-4°F) are reference values and not guaranteed values. Do not use these reference values for selecting outdoor unit models.

When applying product below -20°C (-4°F), consult your design engineer for cold climate application best practices, including the use of a backup source for heating.

PURY-P-Y(S)NW-A

8. CAPACITY TABLES

Outdoor units

PURY-		P400YSNW-A	P450YSNW-A	P500YSNW-A
Cooling Capacity	kW	45.0	50.0	56.0
	BTU/h	153,500	170,600	191,100
Input	kW	9.17	10.59	12.29

Indoor unit temperature correction

To be used to correct indoor unit capacity only

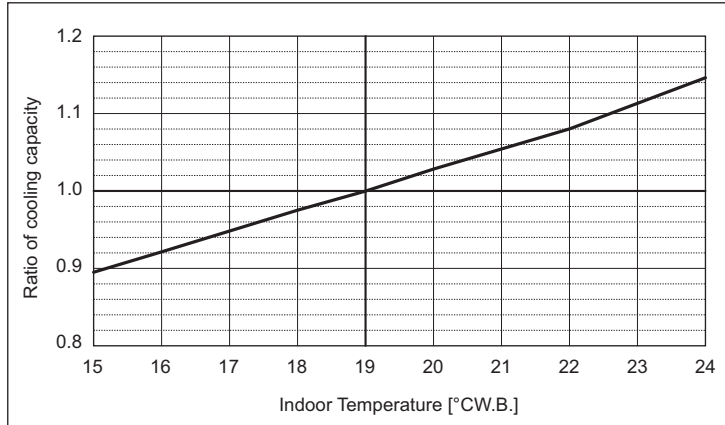

Outdoor unit temperature correction

To be used to correct outdoor unit only

Outdoor unit capacity is NOT affected by the indoor temperature.

Outdoor unit power input is affected by the indoor and outdoor temperatures. Please consult the sales office for details.

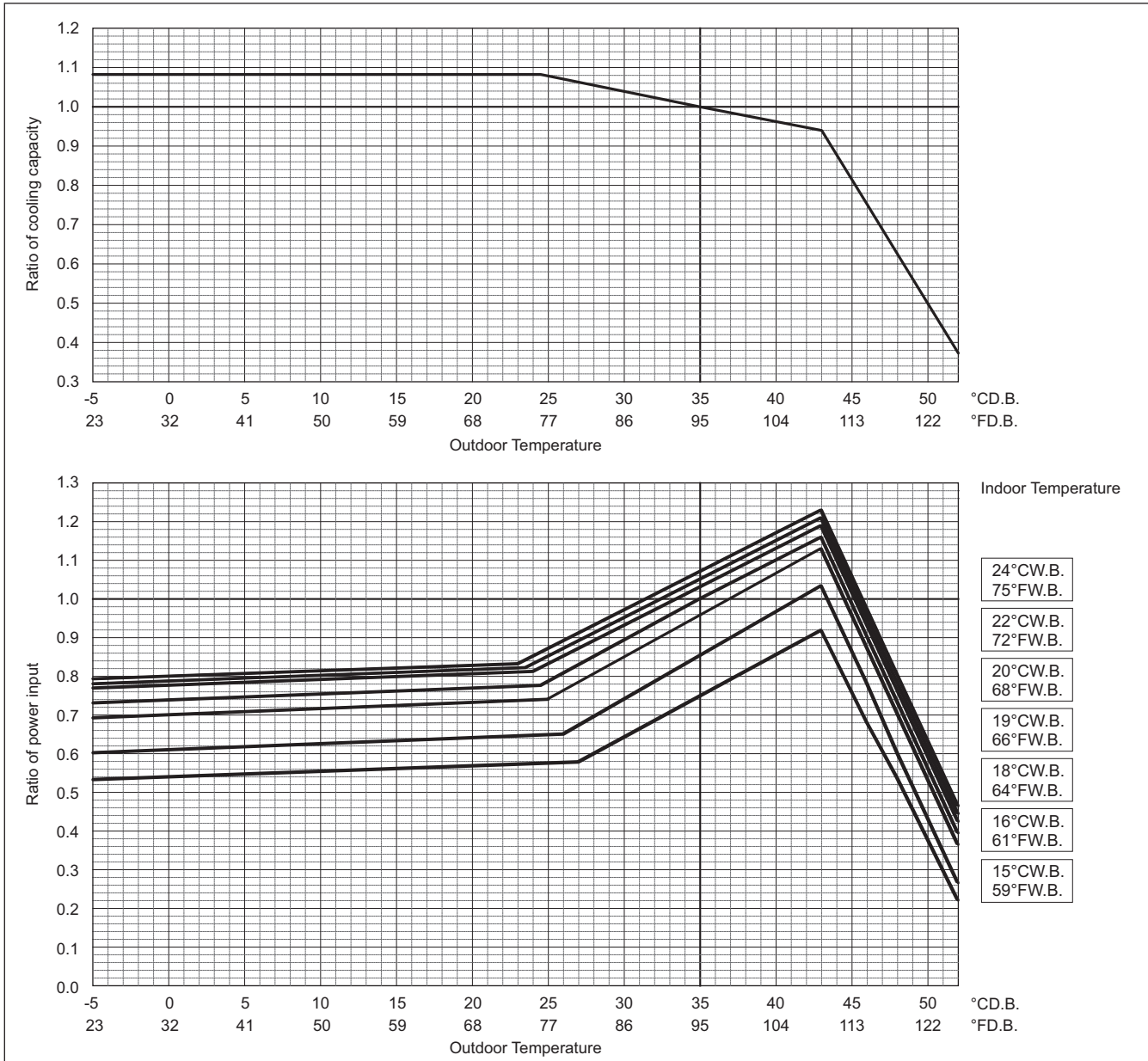

PURY-P-Y(S)NW-A

8. CAPACITY TABLES

Outdoor units

COP Priority Mode

	PURY-	P400YSNW-A	P450YSNW-A	P500YSNW-A
Heating Capacity	kW	50.0	56.0	63.0
	BTU/h	170,600	191,100	215,000
Input	kW	9.72	10.99	12.51

Indoor unit temperature correction

To be used to correct indoor unit capacity only

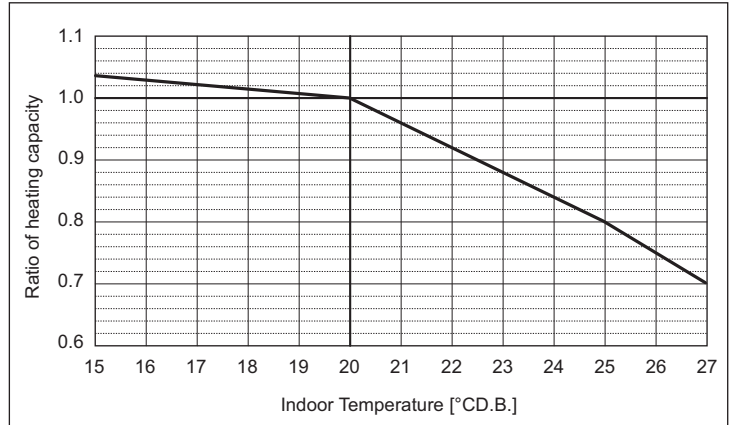

Outdoor unit temperature correction

To be used to correct outdoor unit only

Outdoor unit capacity is NOT affected by the indoor temperature.

Outdoor unit power input is affected by the indoor and outdoor temperatures. Please consult the sales office for details.

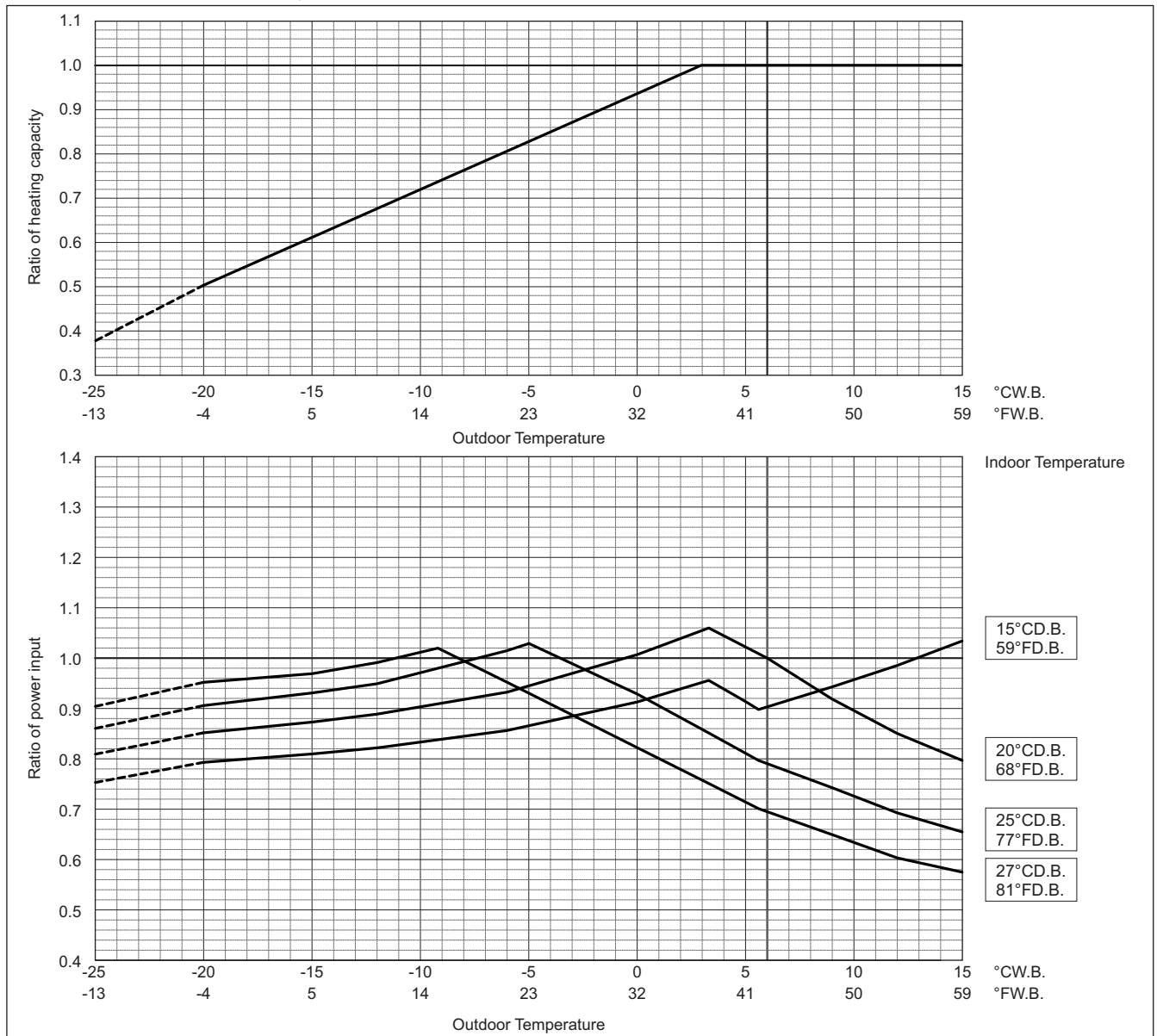

Values in the heating temperature correction diagram in the range below -20°C (-4°F) are reference values and not guaranteed values. Do not use these reference values for selecting outdoor unit models.

When applying product below -20°C (-4°F), consult your design engineer for cold climate application best practices, including the use of a backup source for heating.

PURY-P-Y(S)NW-A

8. CAPACITY TABLES

Outdoor units

PURY-		P550YSNW-A	P600YSNW-A	P650YSNW-A
Cooling Capacity	kW	63.0	69.0	73.0
	BTU/h	215,000	235,400	249,100
Input	kW	14.45	16.62	18.19

PURY-		P700YSNW-A
Cooling Capacity	kW	80.0
	BTU/h	273,000
Input	kW	20.72

Indoor unit temperature correction

To be used to correct indoor unit capacity only

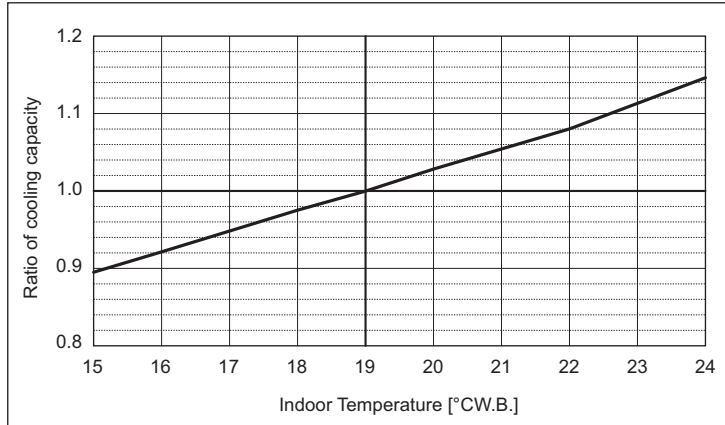

Outdoor unit temperature correction

To be used to correct outdoor unit only

Outdoor unit capacity is NOT affected by the indoor temperature.

Outdoor unit power input is affected by the indoor and outdoor temperatures. Please consult the sales office for details.

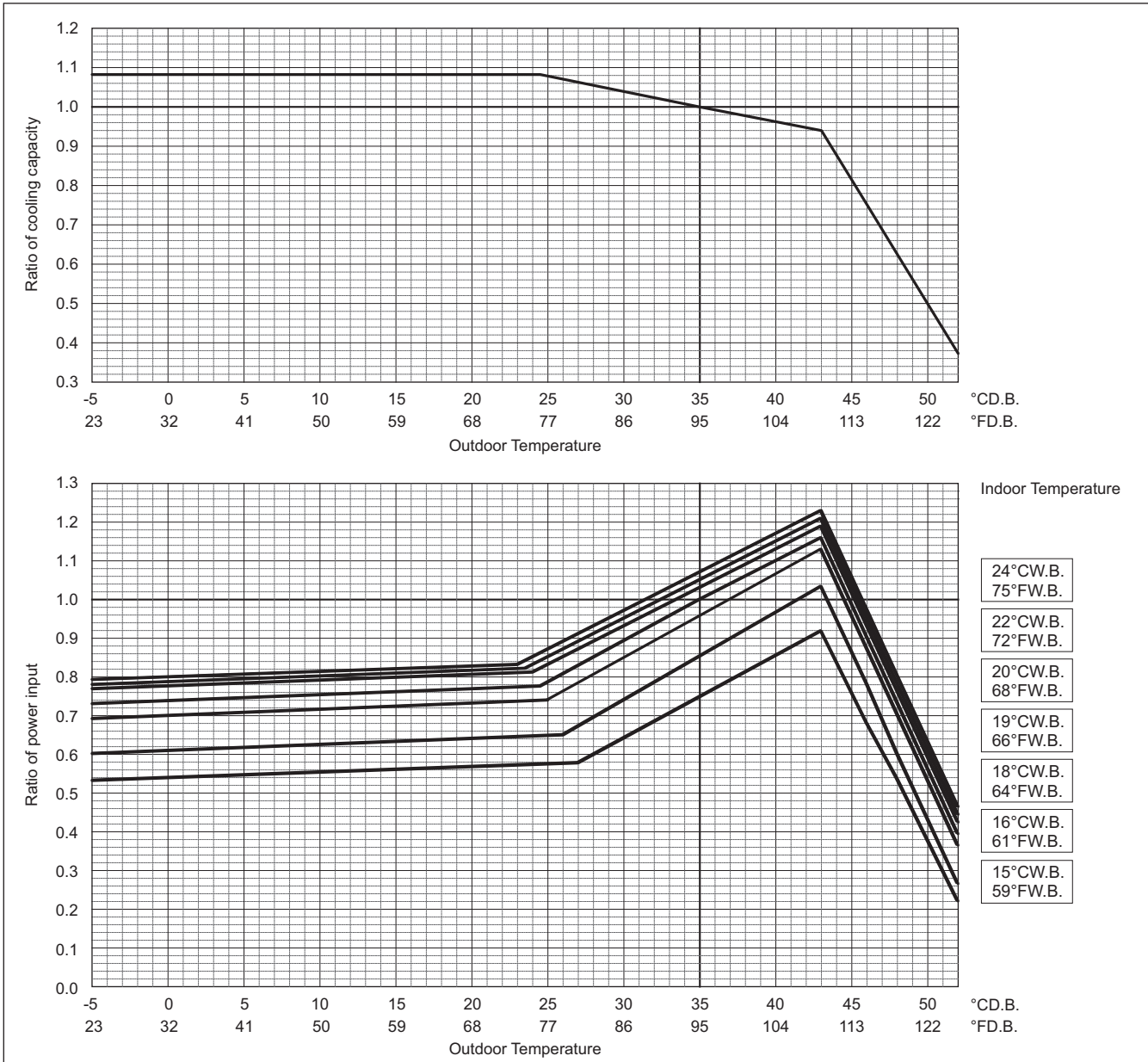

PURY-P-Y(S)NW-A

8. CAPACITY TABLES

COP Priority Mode

PURY-		P550YSNW-A	P600YSNW-A	P650YSNW-A
Heating Capacity	kW	69.0	76.5	81.5
	BTU/h	235,400	261,000	278,100
Input	kW	14.70	17.62	19.35

PURY-		P700YSNW-A
Heating Capacity	kW	88.0
	BTU/h	300,300
Input	kW	21.56

Indoor unit temperature correction

To be used to correct indoor unit capacity only

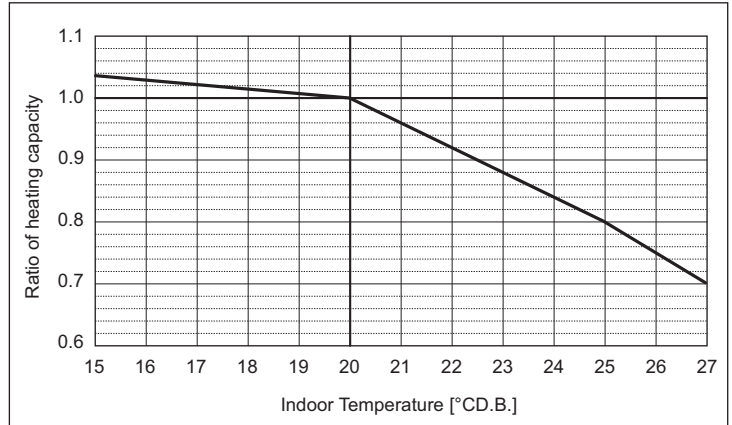

Outdoor unit temperature correction

To be used to correct outdoor unit only

Outdoor unit capacity is NOT affected by the indoor temperature.

Outdoor unit power input is affected by the indoor and outdoor temperatures. Please consult the sales office for details.

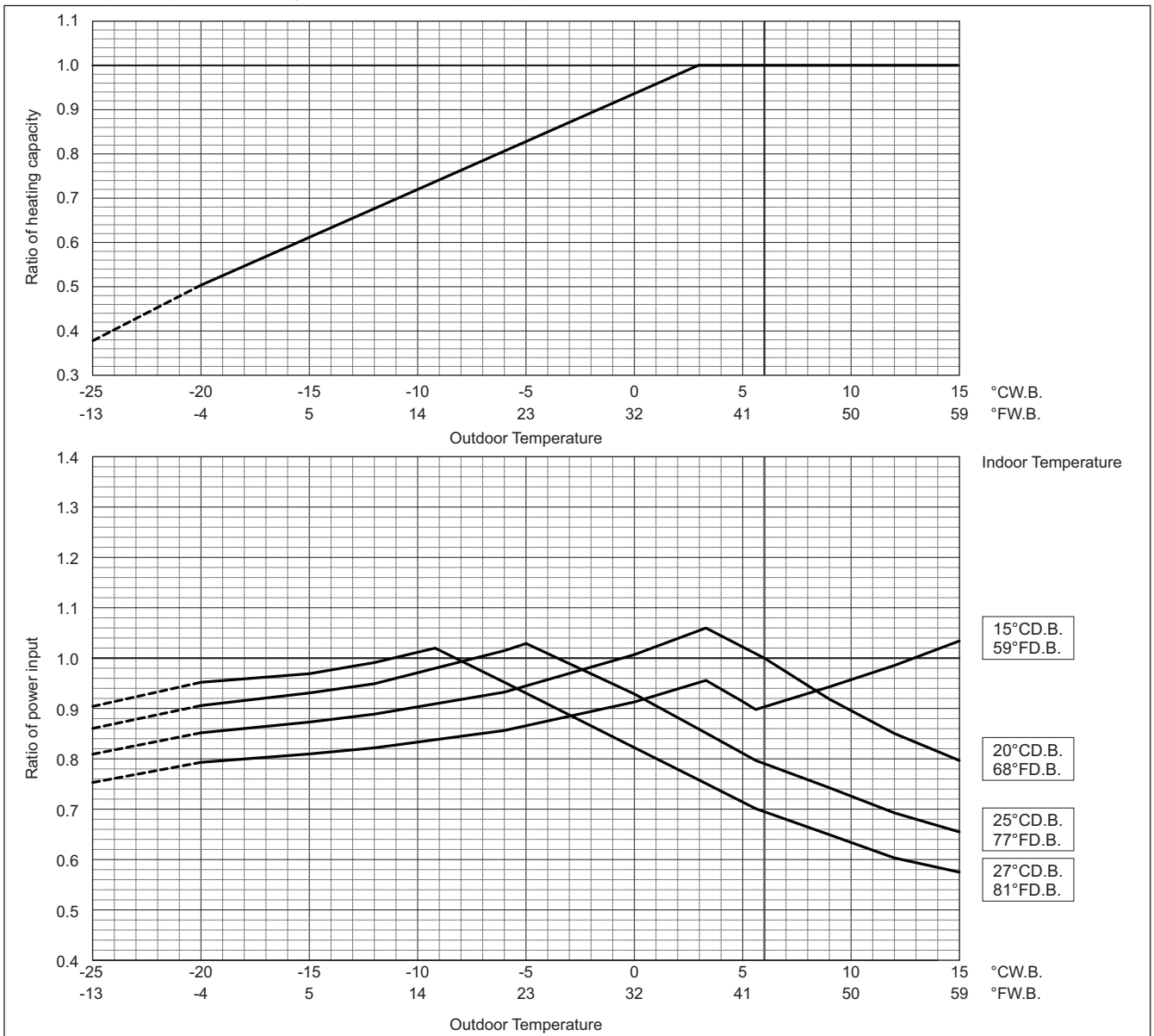

Values in the heating temperature correction diagram in the range below -20°C (-4°F) are reference values and not guaranteed values. Do not use these reference values for selecting outdoor unit models.

When applying product below -20°C (-4°F), consult your design engineer for cold climate application best practices, including the use of a backup source for heating.

PURY-P-Y(S)NW-A

8. CAPACITY TABLES

Outdoor units

PURY-		P750YSNW-A
Cooling Capacity	kW	85.0
	BTU/h	290,000
Input	kW	22.30

Indoor unit temperature correction

To be used to correct indoor unit capacity only

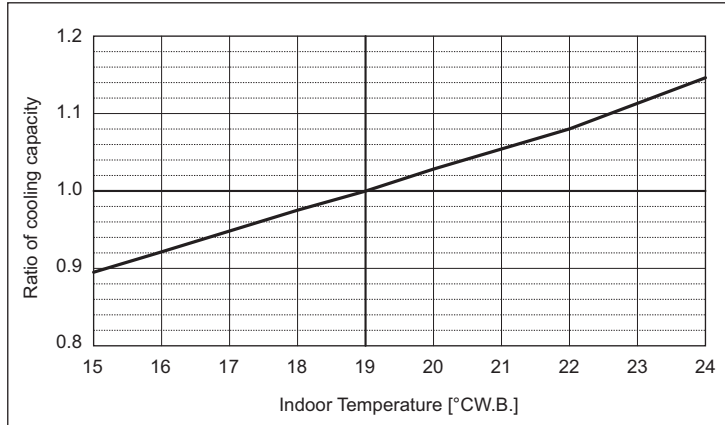

Outdoor unit temperature correction

To be used to correct outdoor unit only

Outdoor unit capacity is NOT affected by the indoor temperature.

Outdoor unit power input is affected by the indoor and outdoor temperatures. Please consult the sales office for details.

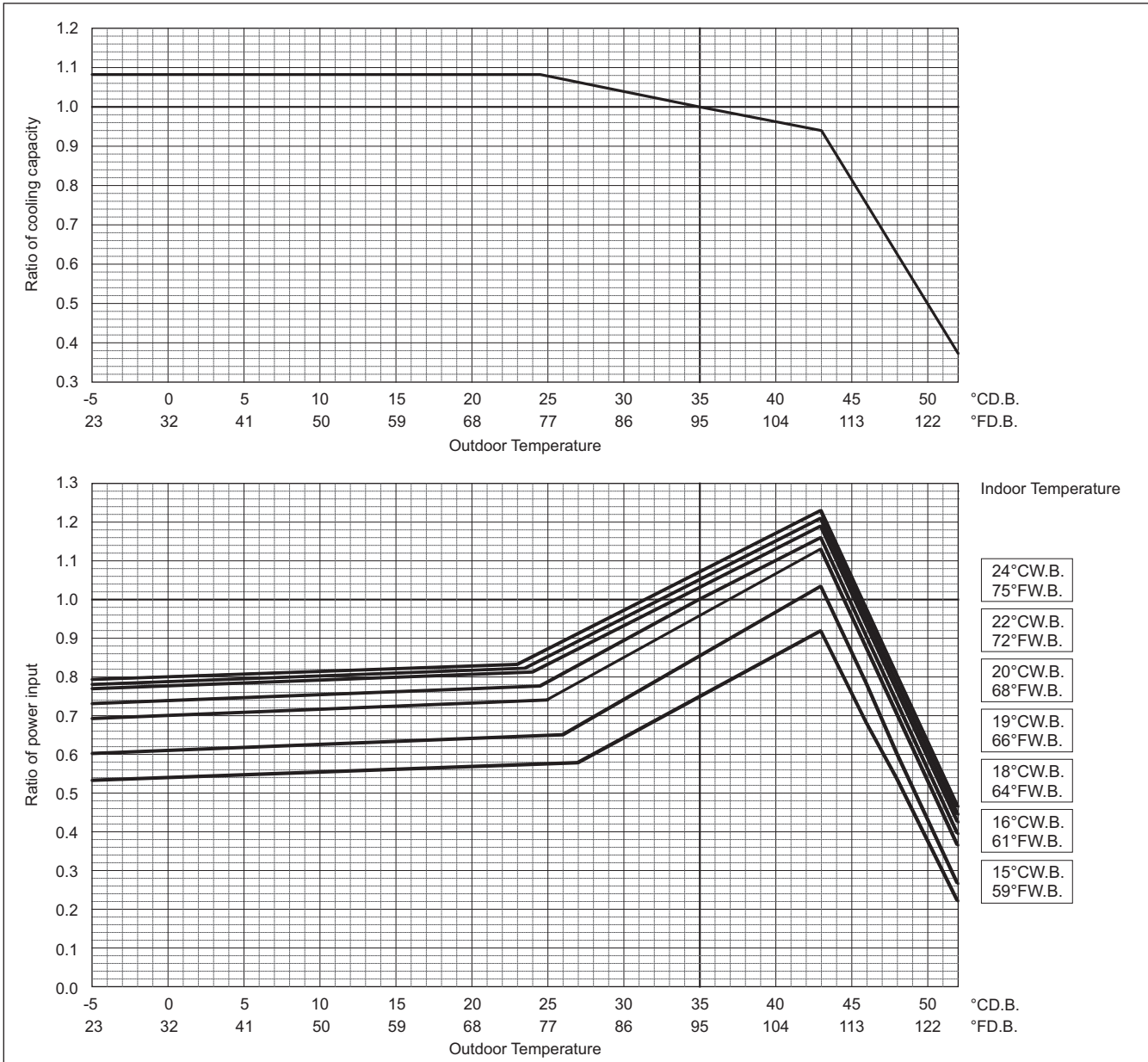

PURY-P-Y(S)NW-A

8. CAPACITY TABLES

COP Priority Mode

	PURY-	P750YSNW-A
Heating Capacity	kW	95.0
	BTU/h	324,100
Input	kW	24.86

Indoor unit temperature correction

To be used to correct indoor unit capacity only

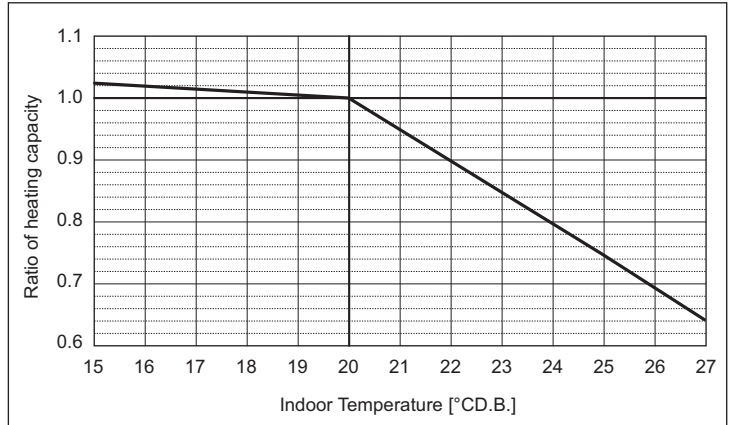

Outdoor unit temperature correction

To be used to correct outdoor unit only

Outdoor unit capacity is NOT affected by the indoor temperature.

Outdoor unit power input is affected by the indoor and outdoor temperatures. Please consult the sales office for details.

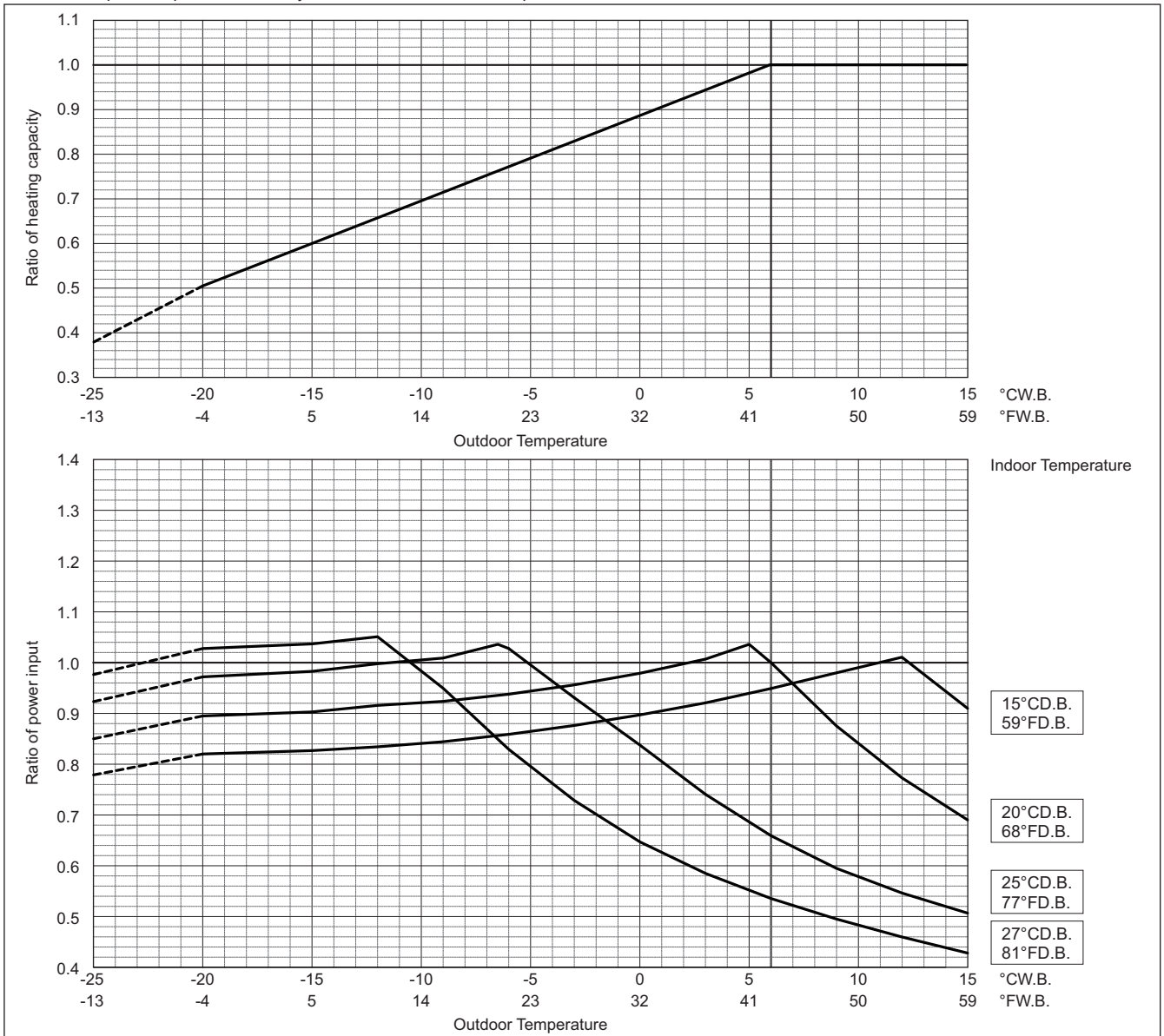

Values in the heating temperature correction diagram in the range below -20°C (-4°F) are reference values and not guaranteed values. Do not use these reference values for selecting outdoor unit models.

When applying product below -20°C (-4°F), consult your design engineer for cold climate application best practices, including the use of a backup source for heating.

PURY-P-Y(S)NW-A

8. CAPACITY TABLES

Outdoor units

PURY-		P800YSNW-A	P850YSNW-A	P900YSNW-A
Cooling Capacity	kW	90.0	96.0	101.0
	BTU/h	307,100	327,600	344,600
Input	kW	23.93	24.99	25.76

PURY-		P950YSNW-A	P1000YSNW-A
Cooling Capacity	kW	108.0	113.0
	BTU/h	368,500	385,600
Input	kW	26.40	26.45

Indoor unit temperature correction

To be used to correct indoor unit capacity only

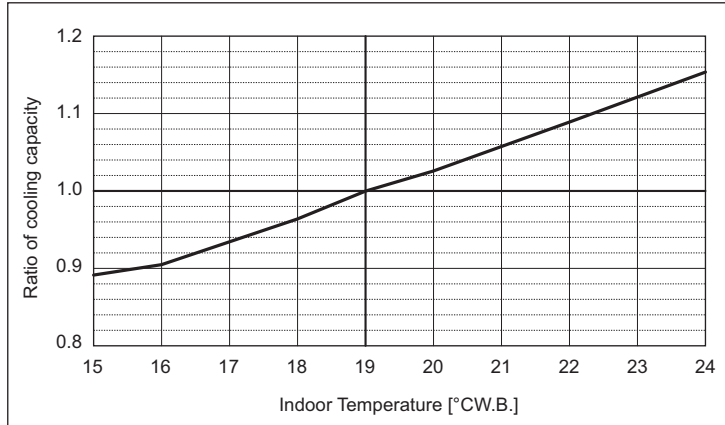

Outdoor unit temperature correction

To be used to correct outdoor unit only

Outdoor unit capacity is NOT affected by the indoor temperature.

Outdoor unit power input is affected by the indoor and outdoor temperatures. Please consult the sales office for details.

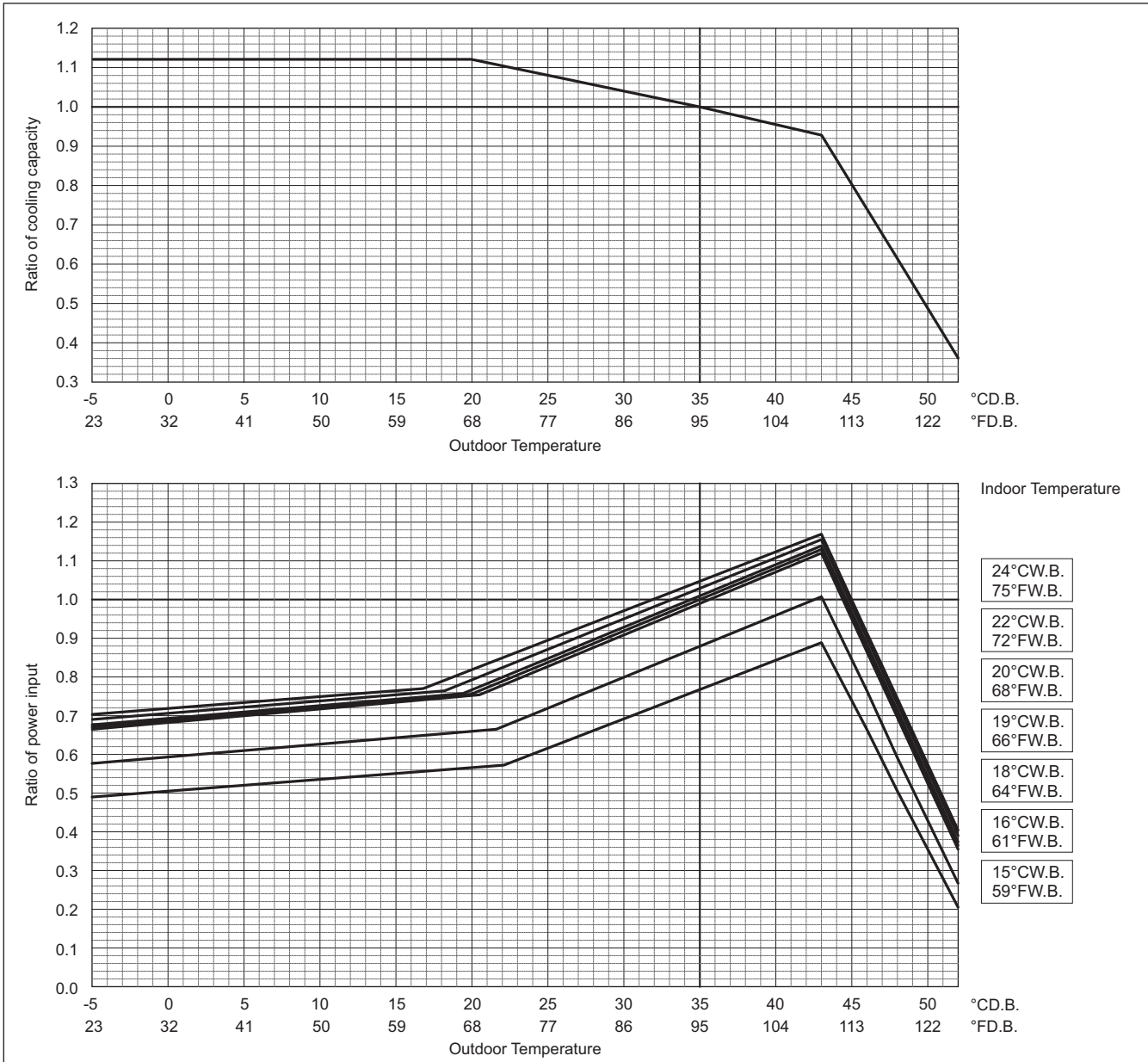

PURY-P-Y(S)NW-A

8. CAPACITY TABLES

COP Priority Mode

PURY-		P800YSNW-A	P850YSNW-A	P900YSNW-A
Heating Capacity	kW	100.0	108.0	113.0
	BTU/h	341,200	368,500	385,600
Input	kW	28.16	28.49	28.03

PURY-		P950YSNW-A	P1000YSNW-A
Heating Capacity	kW	119.5	127.0
	BTU/h	407,700	433,300
Input	kW	29.79	31.74

Indoor unit temperature correction

To be used to correct indoor unit capacity only

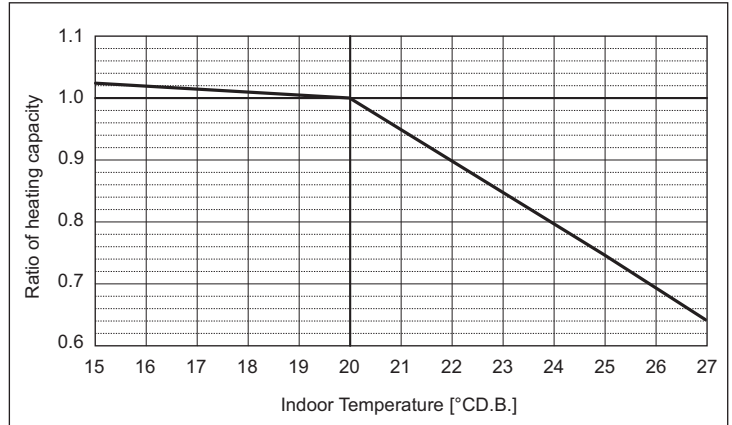

Outdoor unit temperature correction

To be used to correct outdoor unit only

Outdoor unit capacity is NOT affected by the indoor temperature.

Outdoor unit power input is affected by the indoor and outdoor temperatures. Please consult the sales office for details.

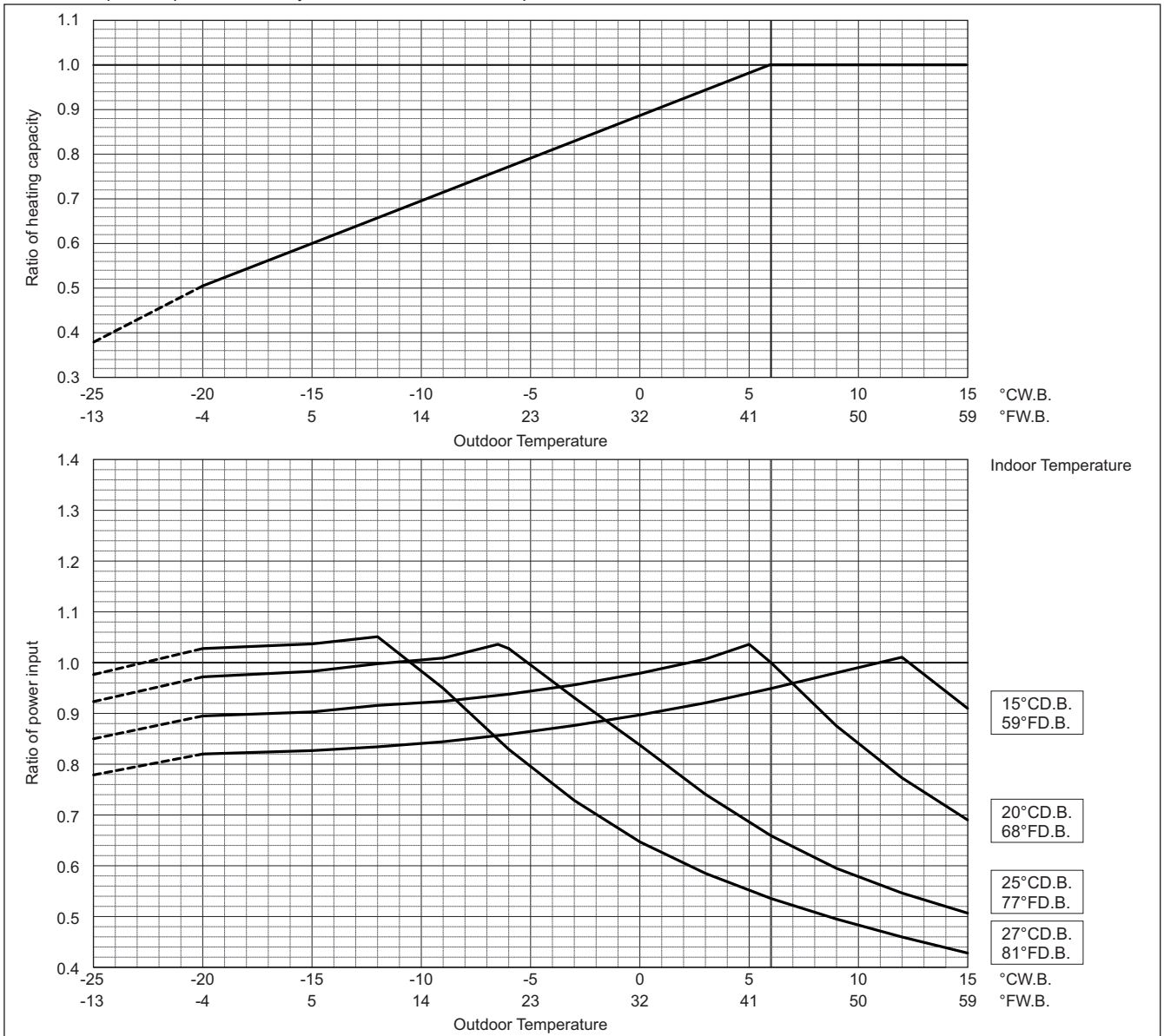

Values in the heating temperature correction diagram in the range below -20°C (-4°F) are reference values and not guaranteed values. Do not use these reference values for selecting outdoor unit models.

When applying product below -20°C (-4°F), consult your design engineer for cold climate application best practices, including the use of a backup source for heating.

8. CAPACITY TABLES

Outdoor units

PURY-		P1050YSNW-A	P1100YSNW-A
Cooling Capacity	kW	118.0	124.0
	BTU/h	402,600	423,100
Input	kW	29.20	32.54

Indoor unit temperature correction

To be used to correct indoor unit capacity only

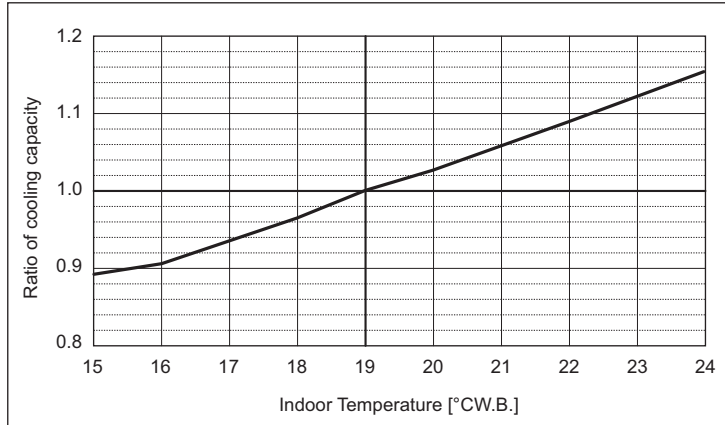

Outdoor unit temperature correction

To be used to correct outdoor unit only

Outdoor unit capacity is NOT affected by the indoor temperature.

Outdoor unit power input is affected by the indoor and outdoor temperatures. Please consult the sales office for details.

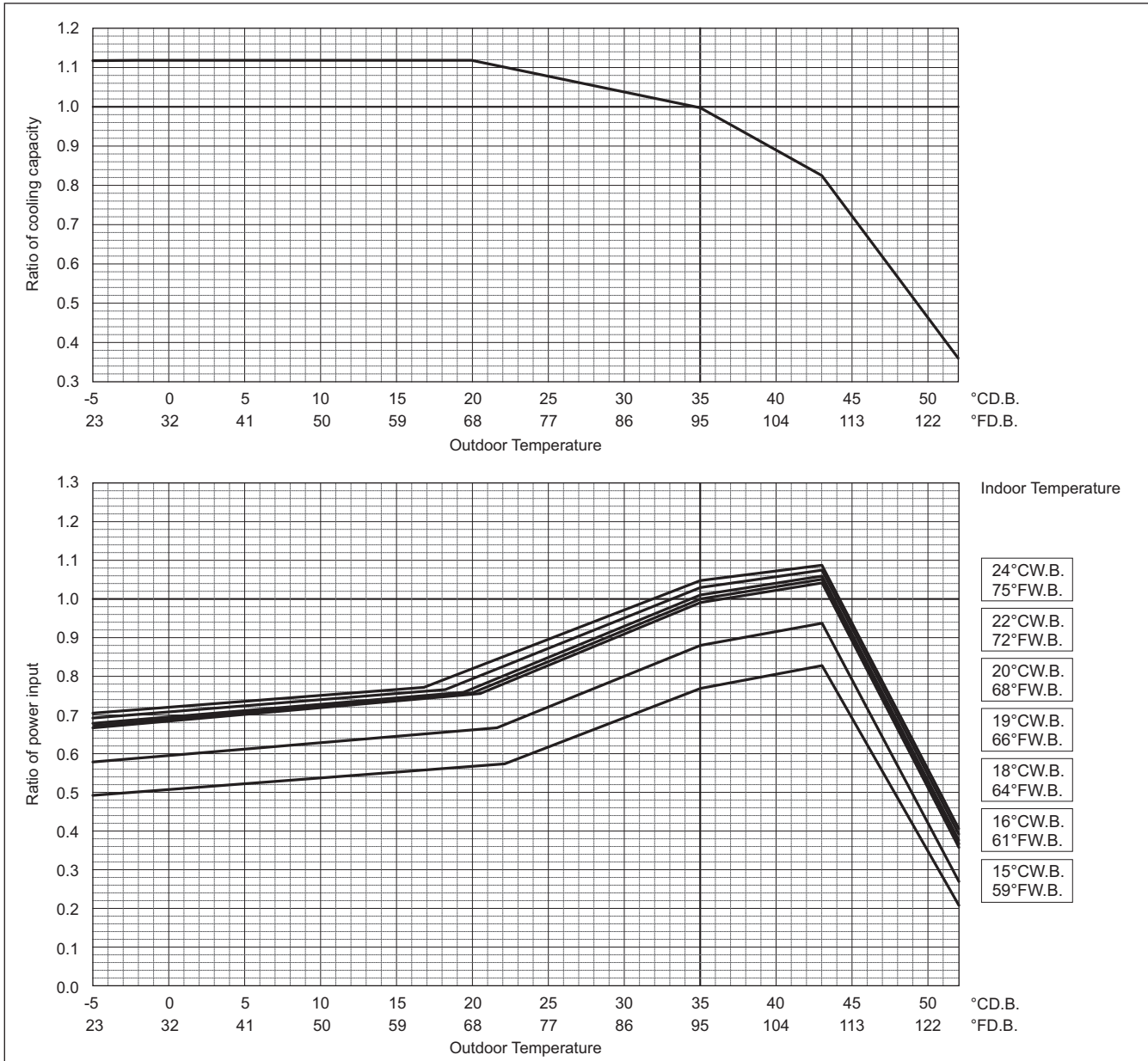

PURY-P-Y(S)NW-A

8. CAPACITY TABLES

COP Priority Mode

	PURY-	P1050YSNW-A	P1100YSNW-A
Heating Capacity	kW	132.0	140.0
	BTU/h	450,400	477,700
Input	kW	34.10	37.52

Indoor unit temperature correction

To be used to correct indoor unit capacity only

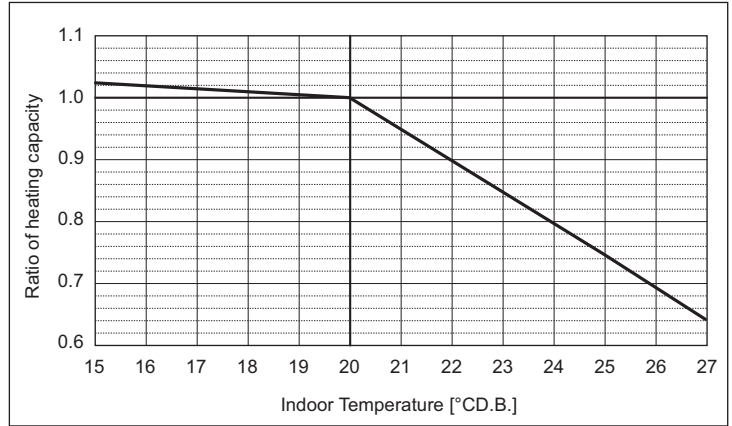

Outdoor unit temperature correction

To be used to correct outdoor unit only

Outdoor unit capacity is NOT affected by the indoor temperature.

Outdoor unit power input is affected by the indoor and outdoor temperatures. Please consult the sales office for details.

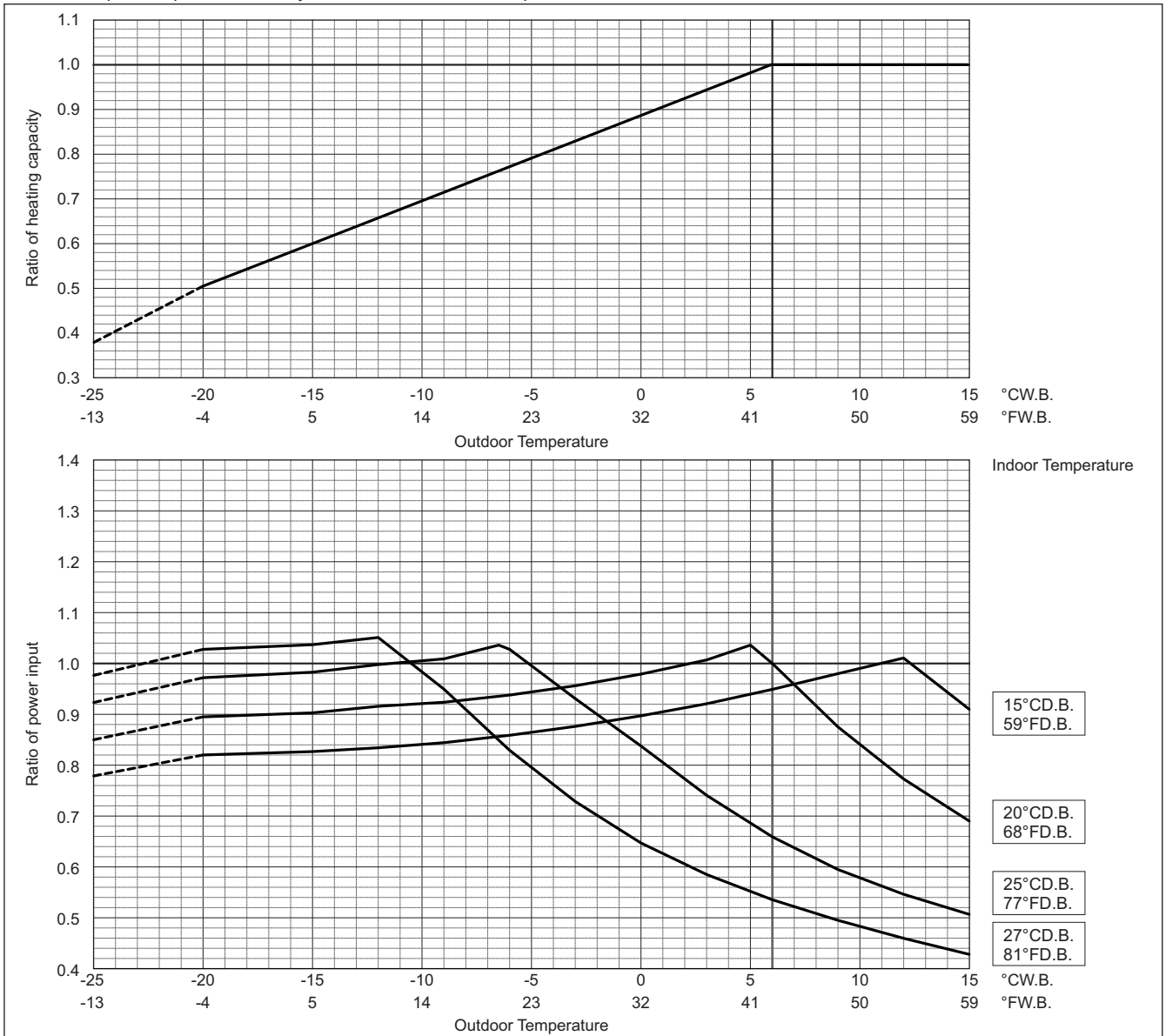

Values in the heating temperature correction diagram in the range below -20°C (-4°F) are reference values and not guaranteed values. Do not use these reference values for selecting outdoor unit models.

When applying product below -20°C (-4°F), consult your design engineer for cold climate application best practices, including the use of a backup source for heating.

8-3. Correction by total indoor

CITY MULTI system has different capacities and inputs when many combinations of indoor units with different total capacities are connected. Using following tables, the maximum capacity can be found to ensure the system is installed with enough capacity for a particular application.

PURY-P200YNW-A		
Cooling Capacity	kW	22.4
	BTU/h	76,400
Input	kW	4.43

PURY-P200YNW-A		
Heating Capacity	kW	25.0
	BTU/h	85,300
Input	kW	4.71

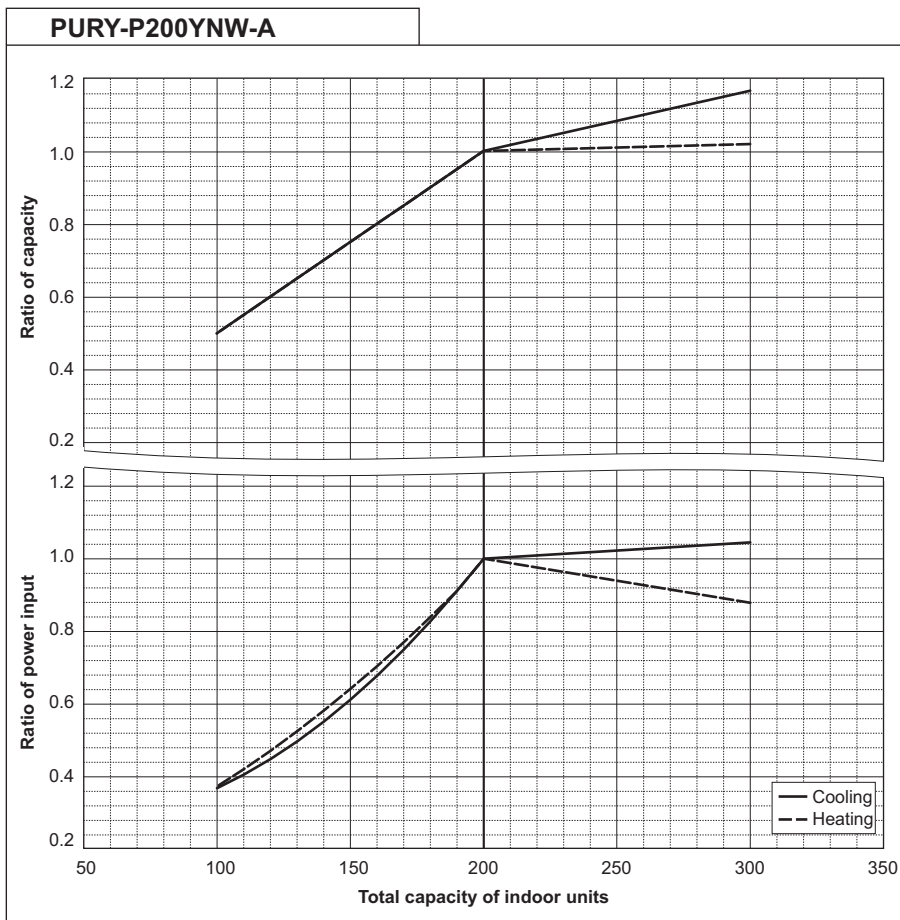

PURY-P250YNW-A		
Cooling Capacity	kW	28.0
	BTU/h	95,500
Input	kW	5.97

PURY-P250YNW-A		
Heating Capacity	kW	31.5
	BTU/h	107,500
Input	kW	6.06

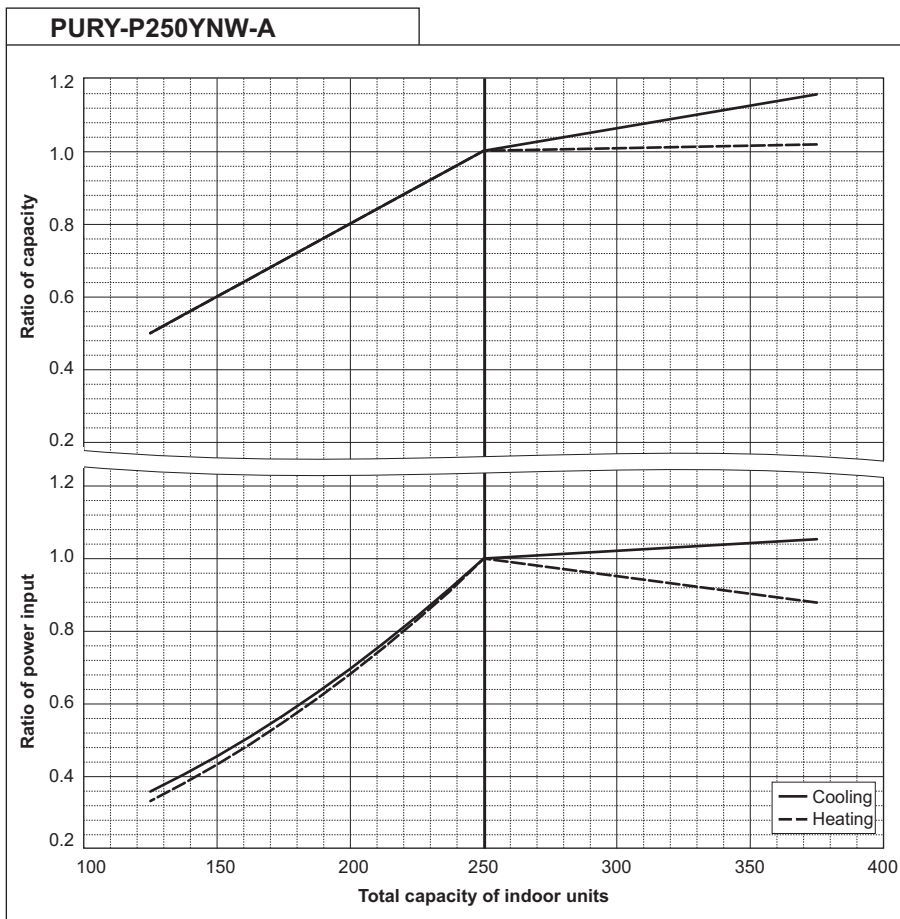

PURY-P-Y(S)NW-A

8. CAPACITY TABLES

Outdoor units

PURY-P300YNW-A		
Cooling Capacity	kW	33.5
	BTU/h	114,300
Input	kW	7.54

PURY-P300YNW-A		
Heating Capacity	kW	37.5
	BTU/h	128,000
Input	kW	8.38

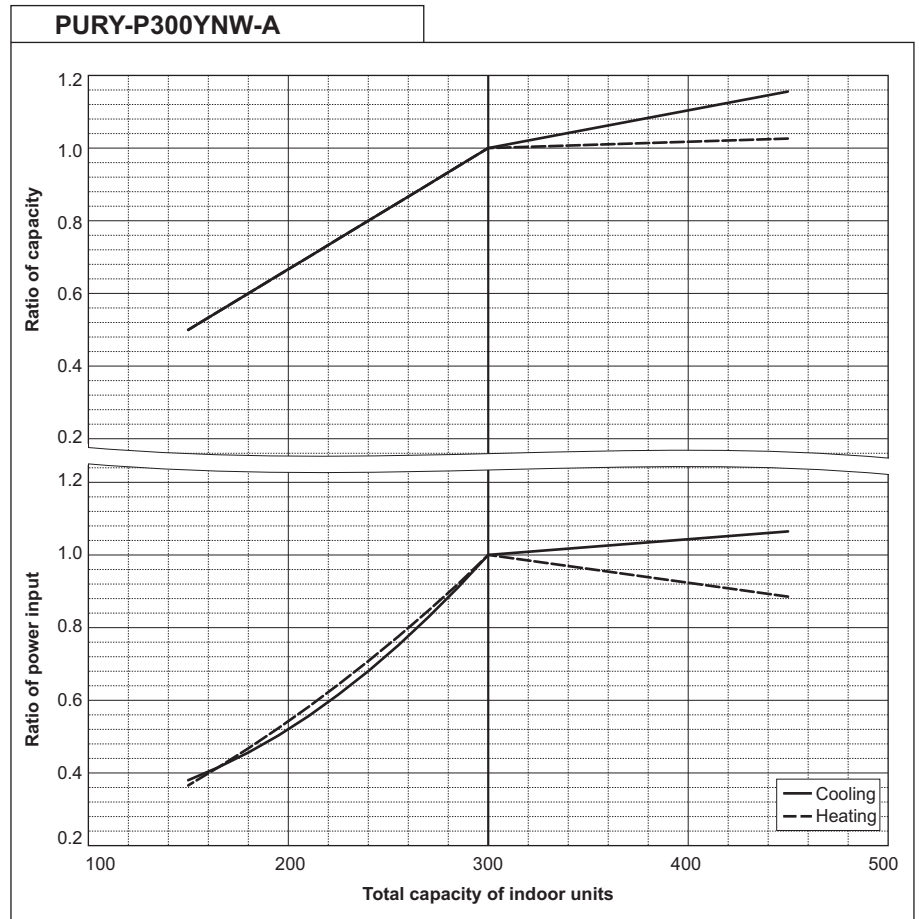

PURY-P350YNW-A		
Cooling Capacity	kW	40.0
	BTU/h	136,500
Input	kW	10.04

PURY-P350YNW-A		
Heating Capacity	kW	45.0
	BTU/h	153,500
Input	kW	10.68

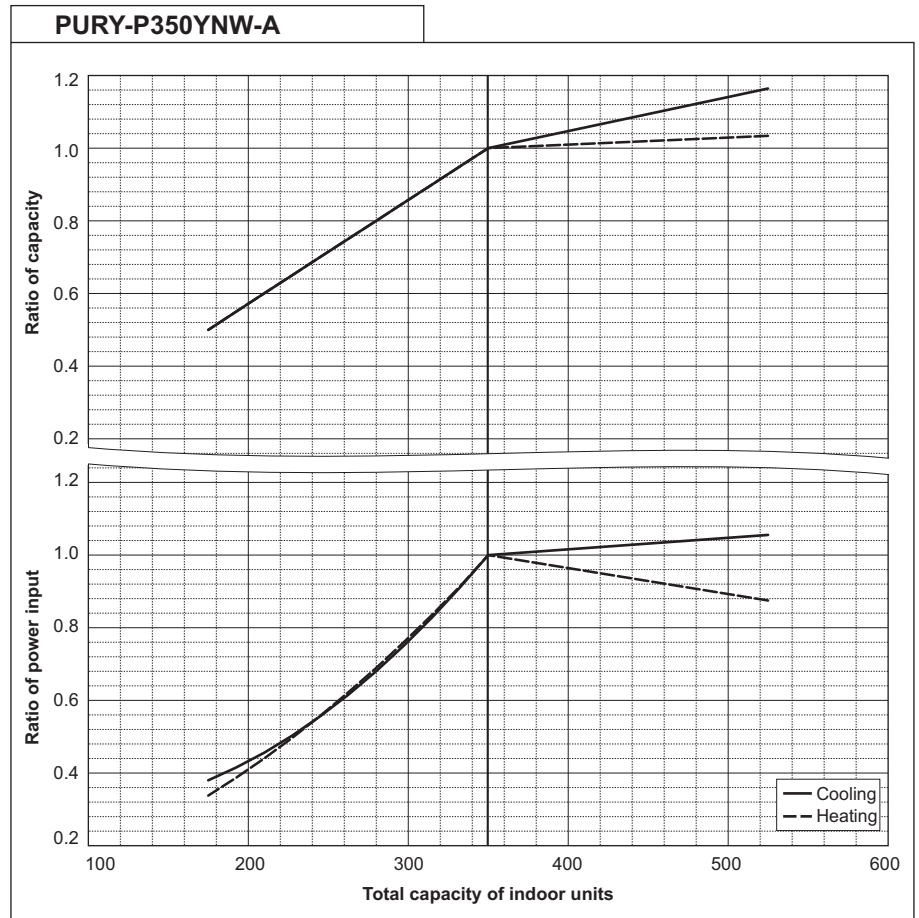

PURY-P-Y(S)NW-A

8. CAPACITY TABLES

Outdoor units

PURY-P400YNW-A		
Cooling Capacity	kW	45.0
	BTU/h	153,500
Input	kW	11.59

PURY-P400YNW-A		
Heating Capacity	kW	50.0
	BTU/h	170,600
Input	kW	13.65

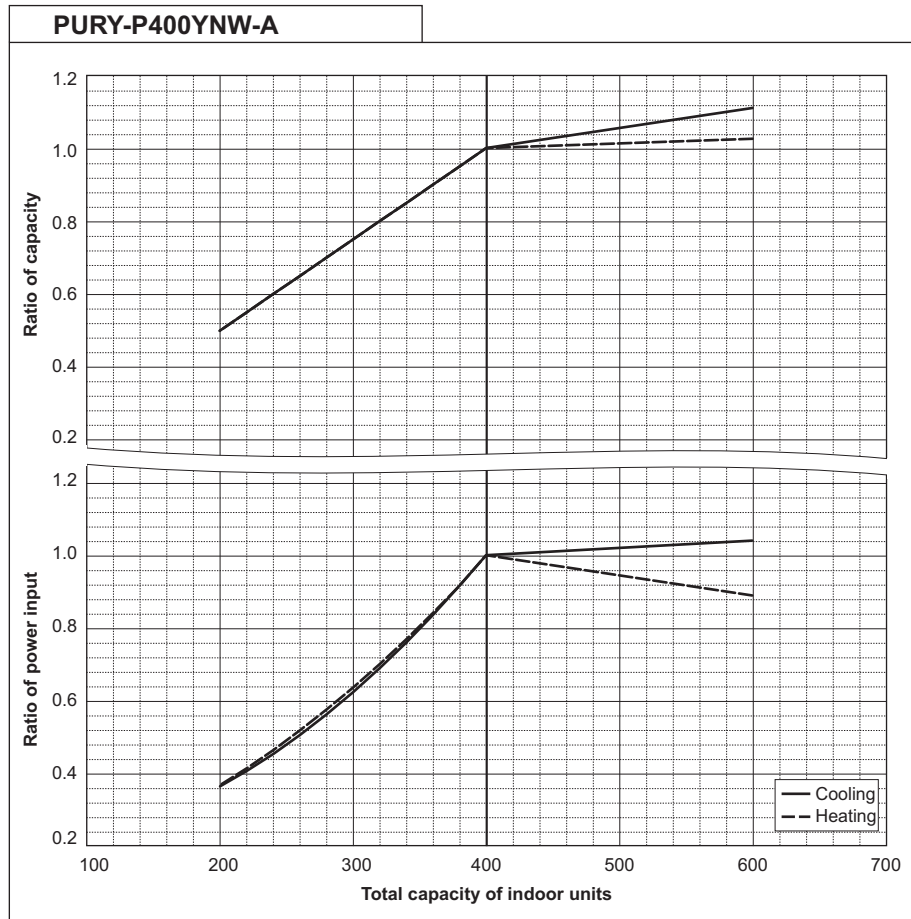

PURY-P450YNW-A		
Cooling Capacity	kW	50.0
	BTU/h	170,600
Input	kW	12.37

PURY-P450YNW-A		
Heating Capacity	kW	56.0
	BTU/h	191,100
Input	kW	13.48

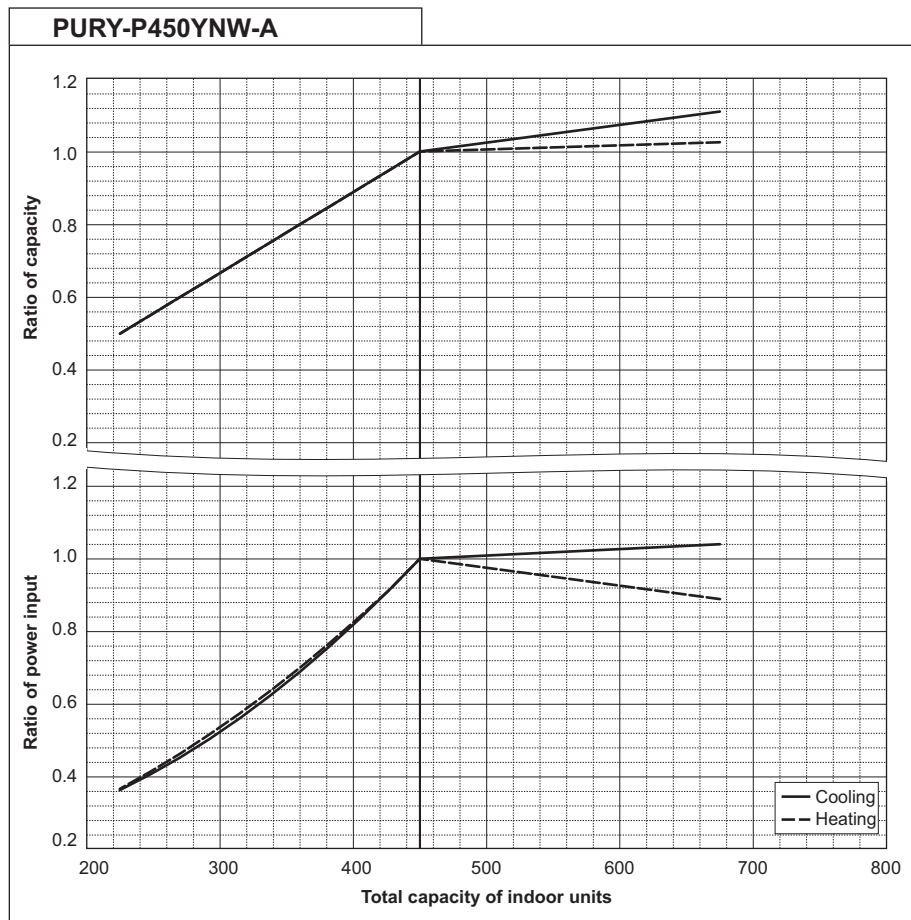

PURY-P-Y(S)NW-A

8. CAPACITY TABLES

Outdoor units

PURY-P500YNW-A		
Cooling Capacity	kW	56.0
	BTU/h	191,100
Input	kW	12.72

PURY-P500YNW-A		
Heating Capacity	kW	63.0
	BTU/h	215,000
Input	kW	15.28

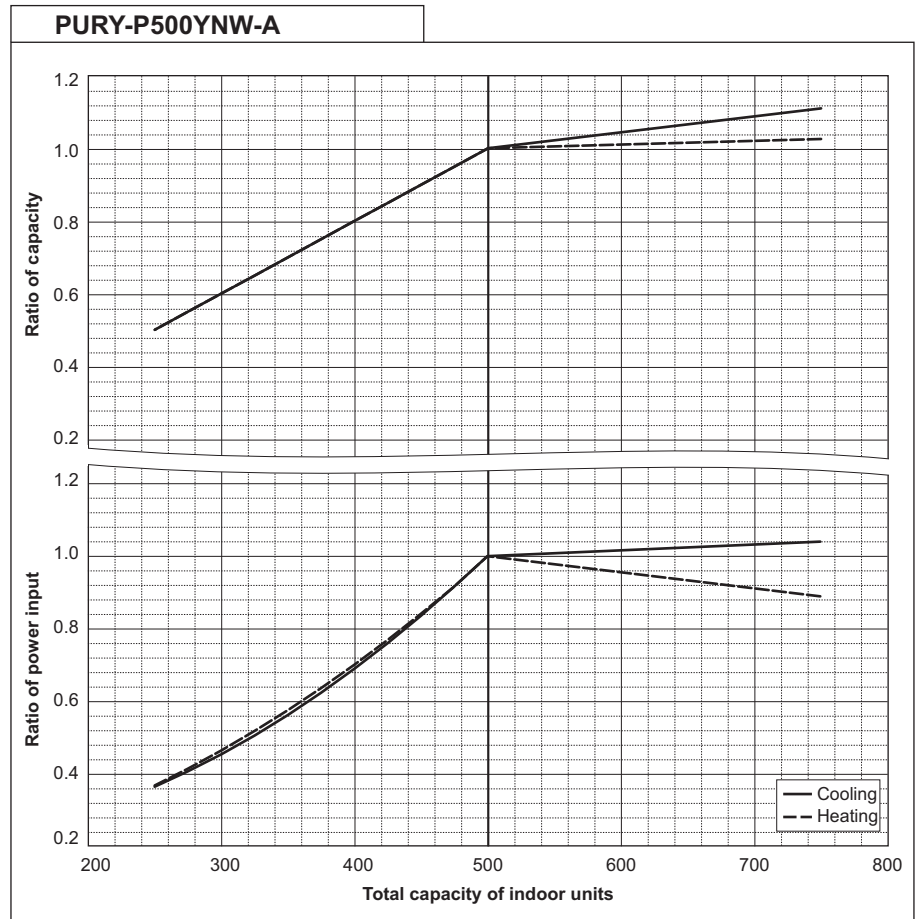

PURY-P550YNW-A		
Cooling Capacity	kW	63.0
	BTU/h	215,000
Input	kW	16.03

PURY-P550YNW-A		
Heating Capacity	kW	69.0
	BTU/h	235,400
Input	kW	17.91

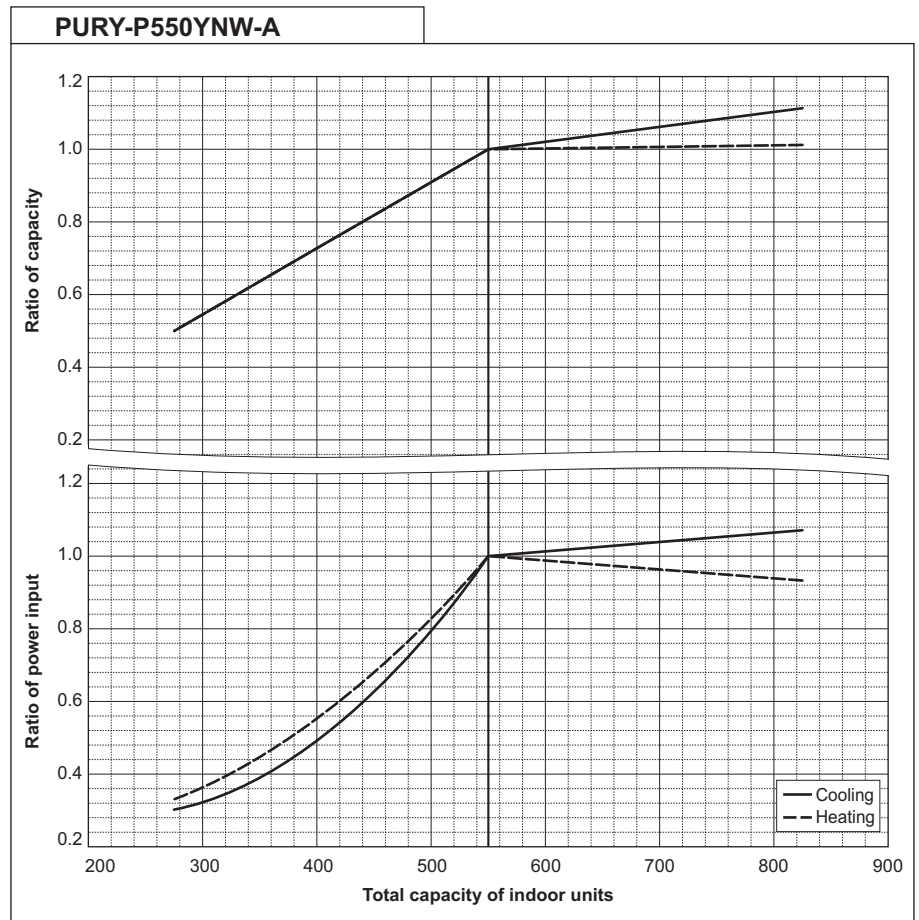

PURY-P-Y(S)NW-A

8. CAPACITY TABLES

Outdoor units

PURY-P400YSNW-A		
Cooling Capacity	kW	45.0
	BTU/h	153,500
Input	kW	9.17

PURY-P400YSNW-A		
Heating Capacity	kW	50.0
	BTU/h	170,600
Input	kW	9.72

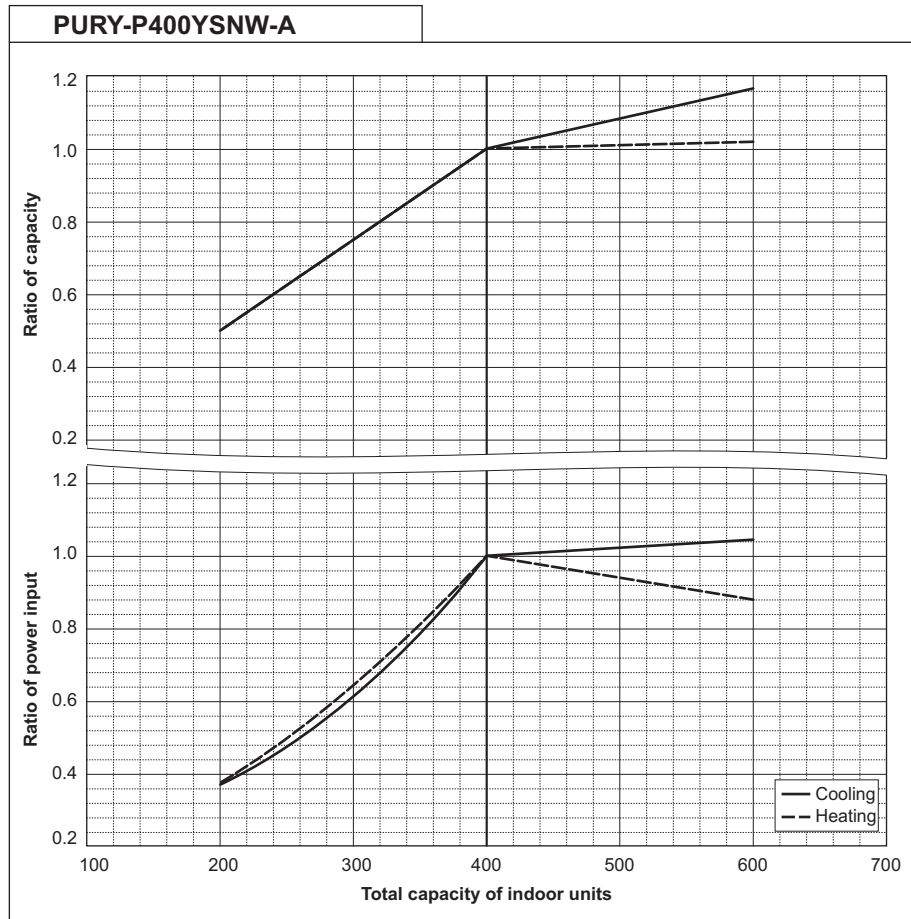

PURY-P450YSNW-A		
Cooling Capacity	kW	50.0
	BTU/h	170,600
Input	kW	10.59

PURY-P450YSNW-A		
Heating Capacity	kW	56.0
	BTU/h	191,100
Input	kW	10.99

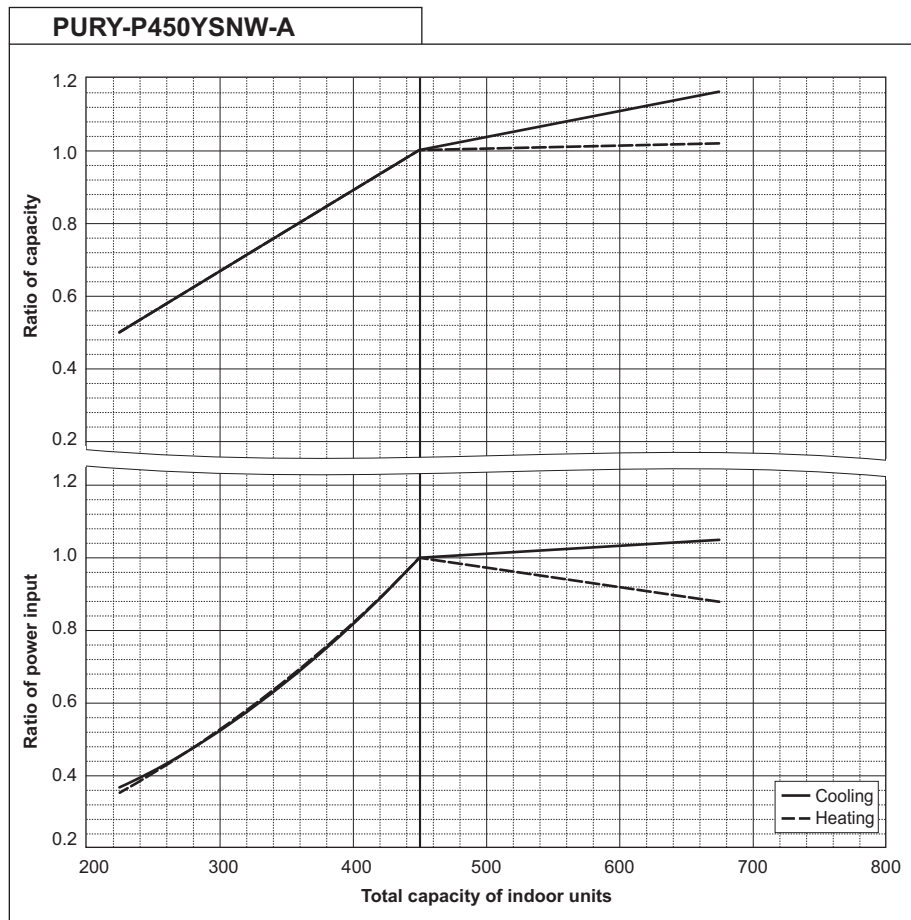

PURY-P-Y(S)NW-A

8. CAPACITY TABLES

PURY-P500YSNW-A		
Cooling Capacity	kW	56.0
	BTU/h	191,100
Input	kW	12.29

PURY-P500YSNW-A		
Heating Capacity	kW	63.0
	BTU/h	215,000
Input	kW	12.51

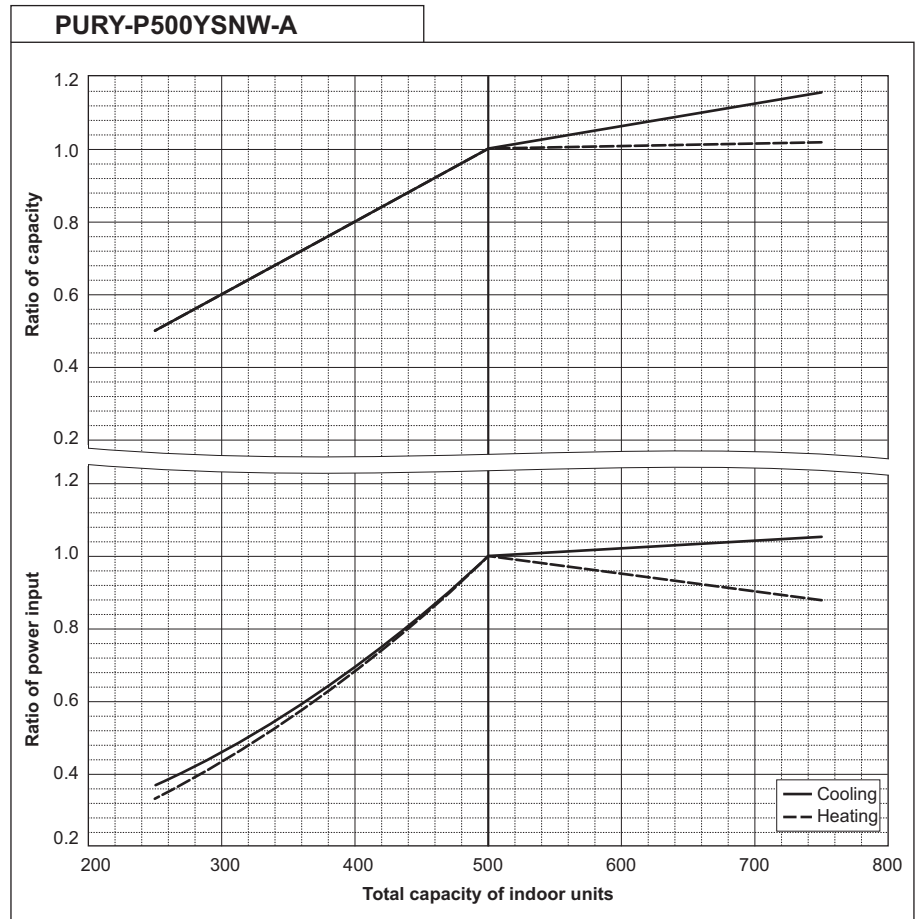

PURY-P550YSNW-A		
Cooling Capacity	kW	63.0
	BTU/h	215,000
Input	kW	14.45

PURY-P550YSNW-A		
Heating Capacity	kW	69.0
	BTU/h	235,400
Input	kW	14.70

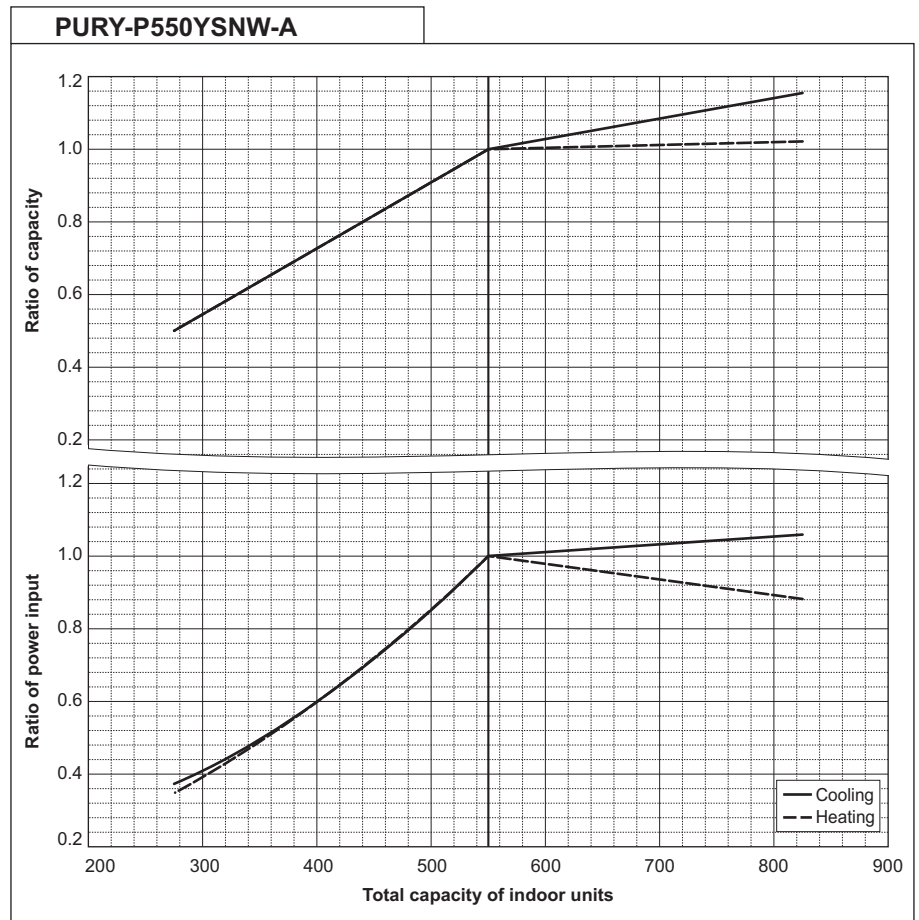

PURY-P-Y(S)NW-A

8. CAPACITY TABLES

Outdoor units

PURY-P600YSNW-A		
Cooling Capacity	kW	69.0
	BTU/h	235,400
Input	kW	16.62

PURY-P600YSNW-A		
Heating Capacity	kW	76.5
	BTU/h	261,000
Input	kW	17.62

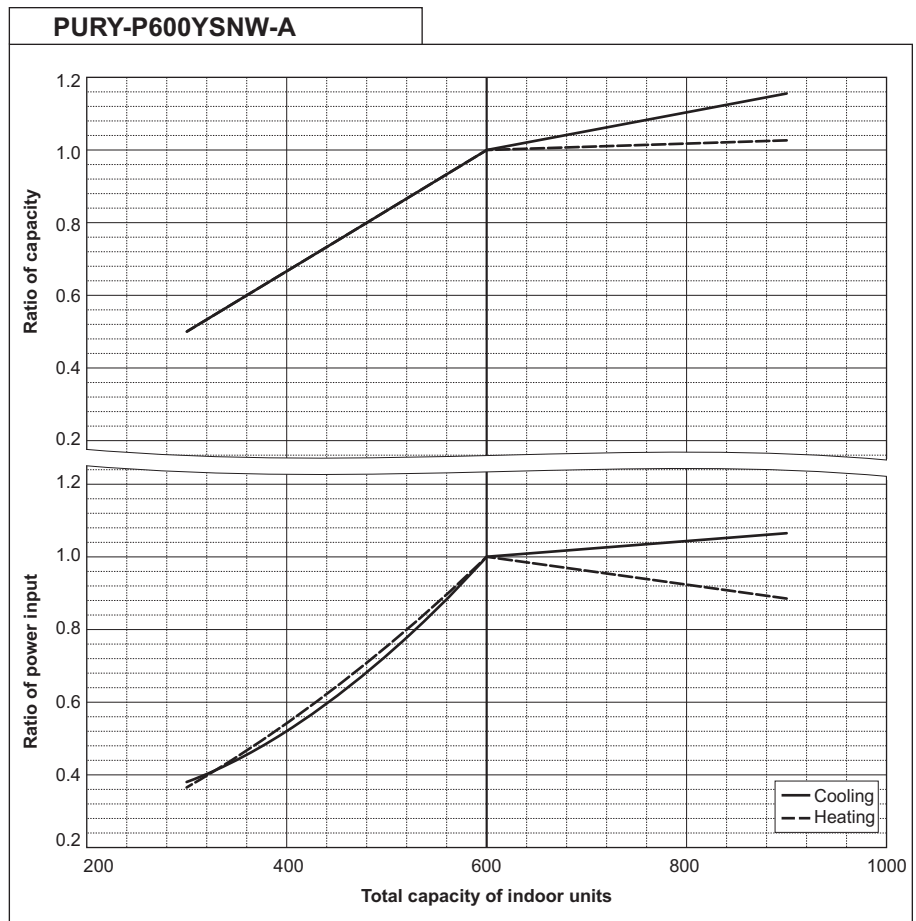

PURY-P650YSNW-A		
Cooling Capacity	kW	73.0
	BTU/h	249,100
Input	kW	18.19

PURY-P650YSNW-A		
Heating Capacity	kW	81.5
	BTU/h	278,100
Input	kW	19.35

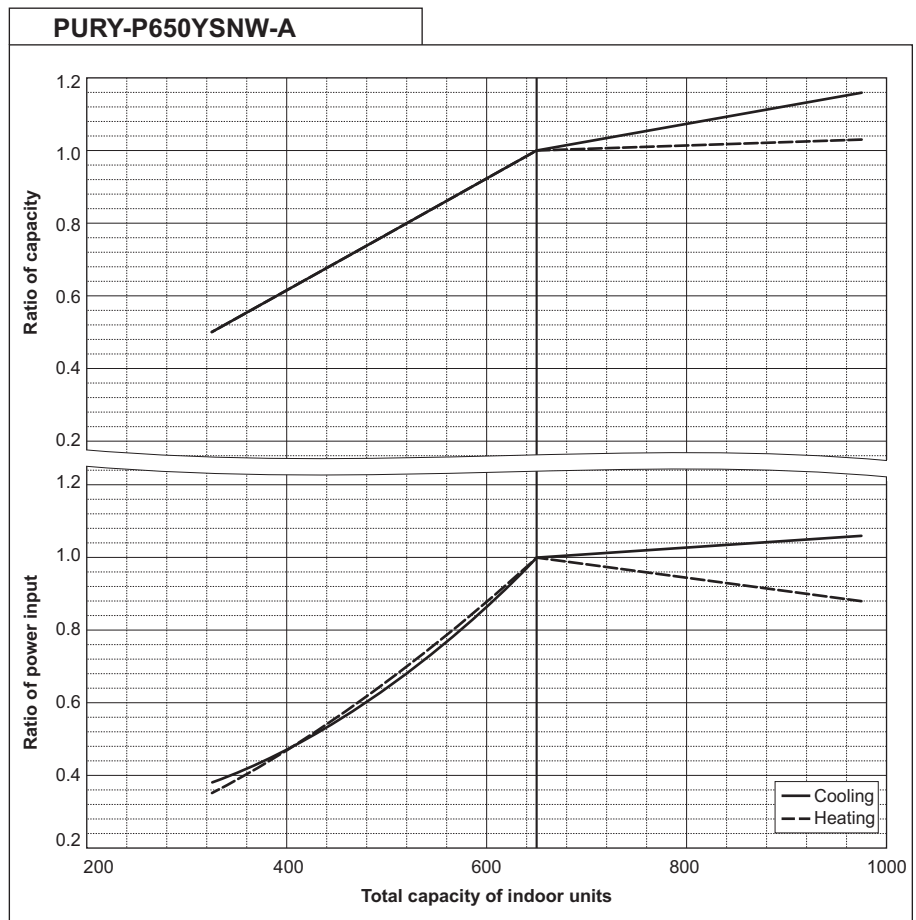

PURY-P-Y(S)NW-A

8. CAPACITY TABLES

Outdoor units

PURY-P700YSNW-A		
Cooling Capacity	kW	80.0
	BTU/h	273,000
Input	kW	20.72

PURY-P700YSNW-A		
Heating Capacity	kW	88.0
	BTU/h	300,300
Input	kW	21.56

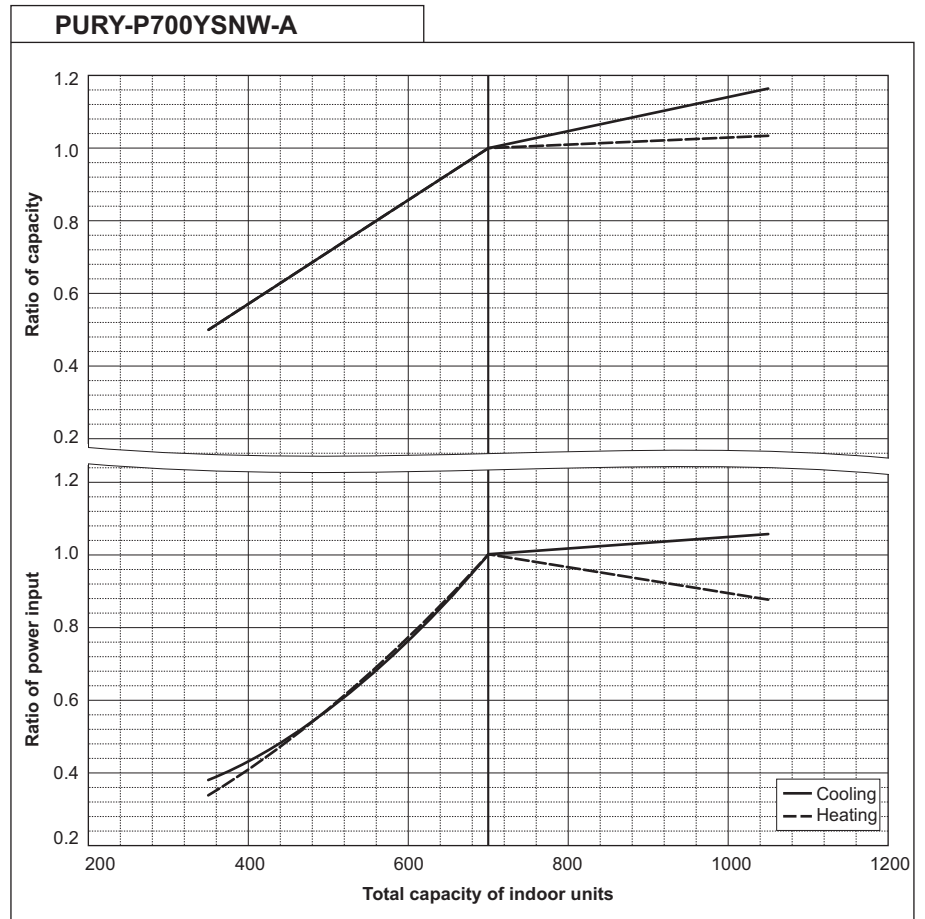

PURY-P750YSNW-A		
Cooling Capacity	kW	85.0
	BTU/h	290,000
Input	kW	22.30

PURY-P750YSNW-A		
Heating Capacity	kW	95.0
	BTU/h	324,100
Input	kW	24.86

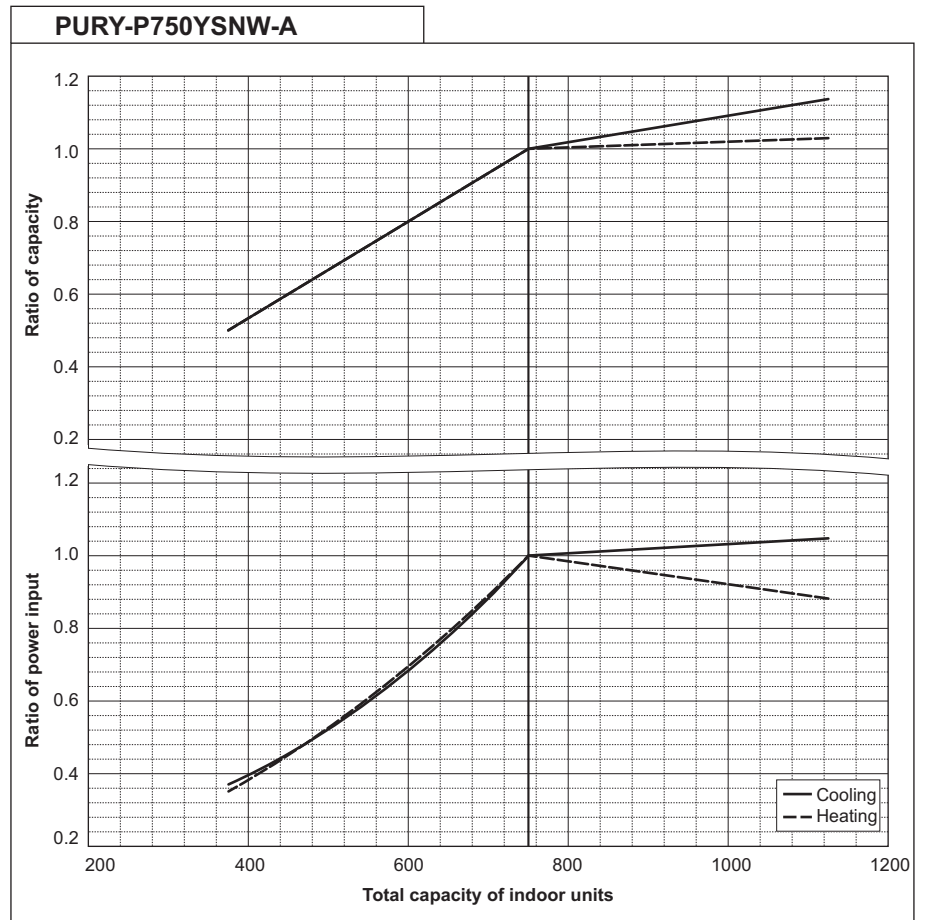

PURY-P-Y(S)NW-A

8. CAPACITY TABLES

Outdoor units

PURY-P800YSNW-A		
Cooling Capacity	kW	90.0
	BTU/h	307,100
Input	kW	23.93

PURY-P800YSNW-A		
Heating Capacity	kW	100.0
	BTU/h	341,200
Input	kW	28.16

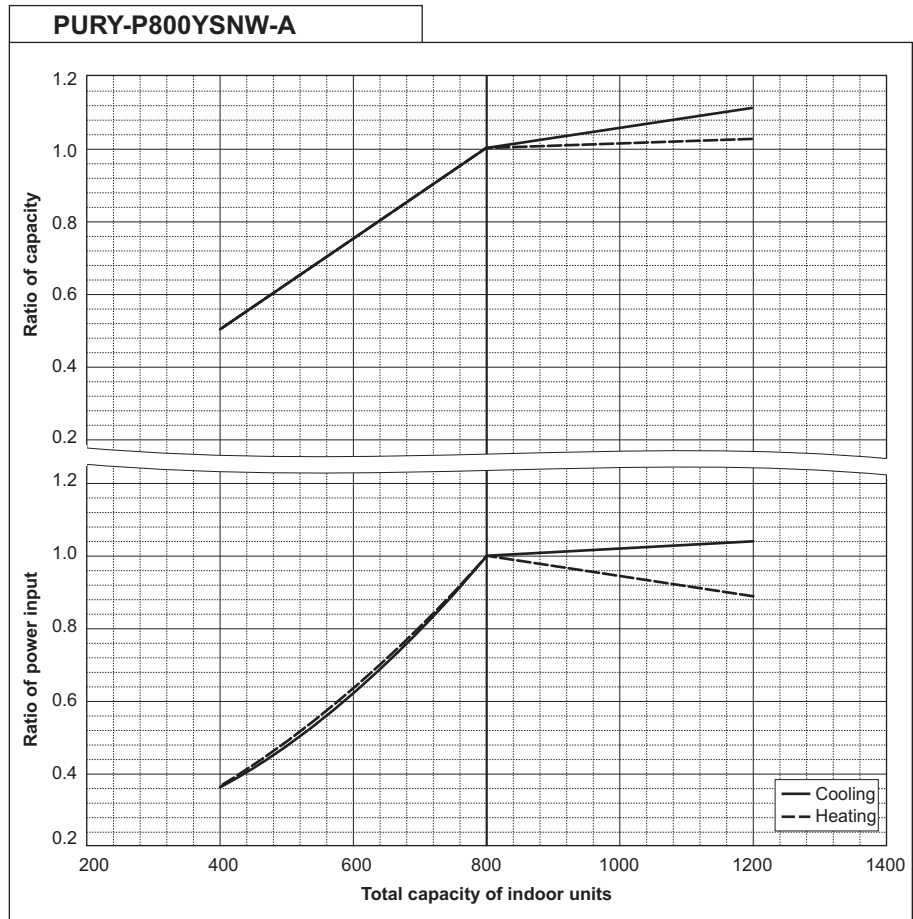

PURY-P850YSNW-A		
Cooling Capacity	kW	96.0
	BTU/h	327,600
Input	kW	24.99

PURY-P850YSNW-A		
Heating Capacity	kW	108.0
	BTU/h	368,500
Input	kW	28.49

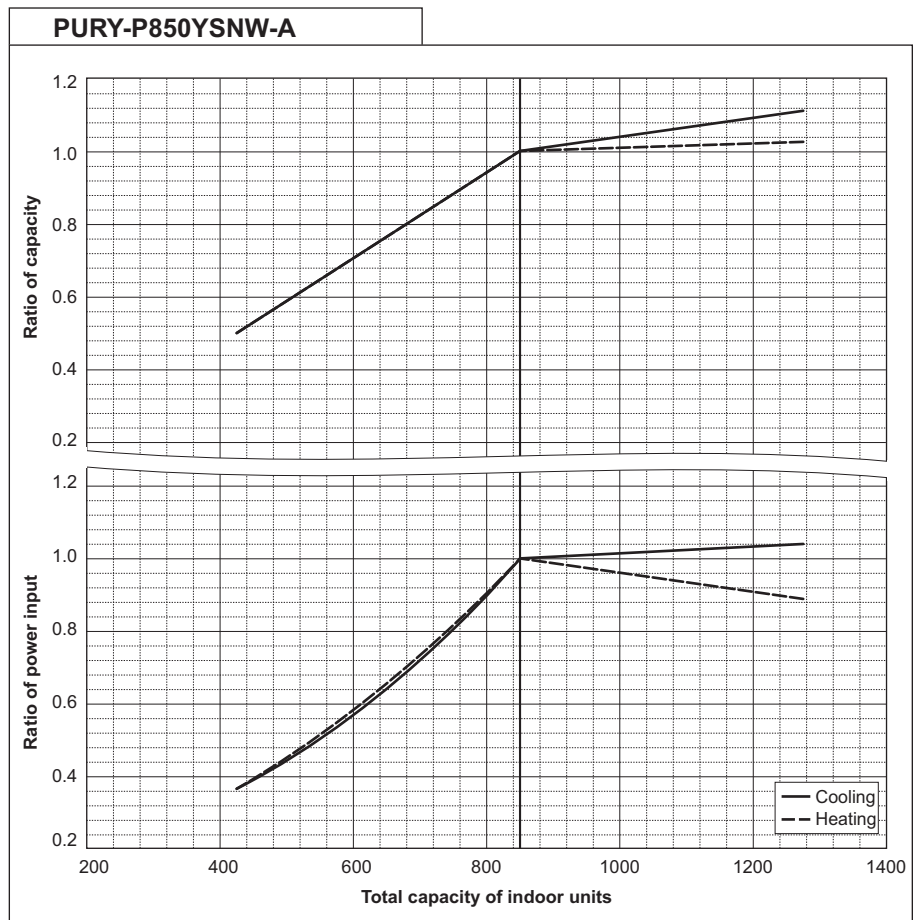

PURY-P-Y(S)NW-A

8. CAPACITY TABLES

Outdoor units

PURY-P900YSNW-A		
Cooling Capacity	kW	101.0
	BTU/h	344,600
Input	kW	25.76

PURY-P900YSNW-A		
Heating Capacity	kW	113.0
	BTU/h	385,600
Input	kW	28.03

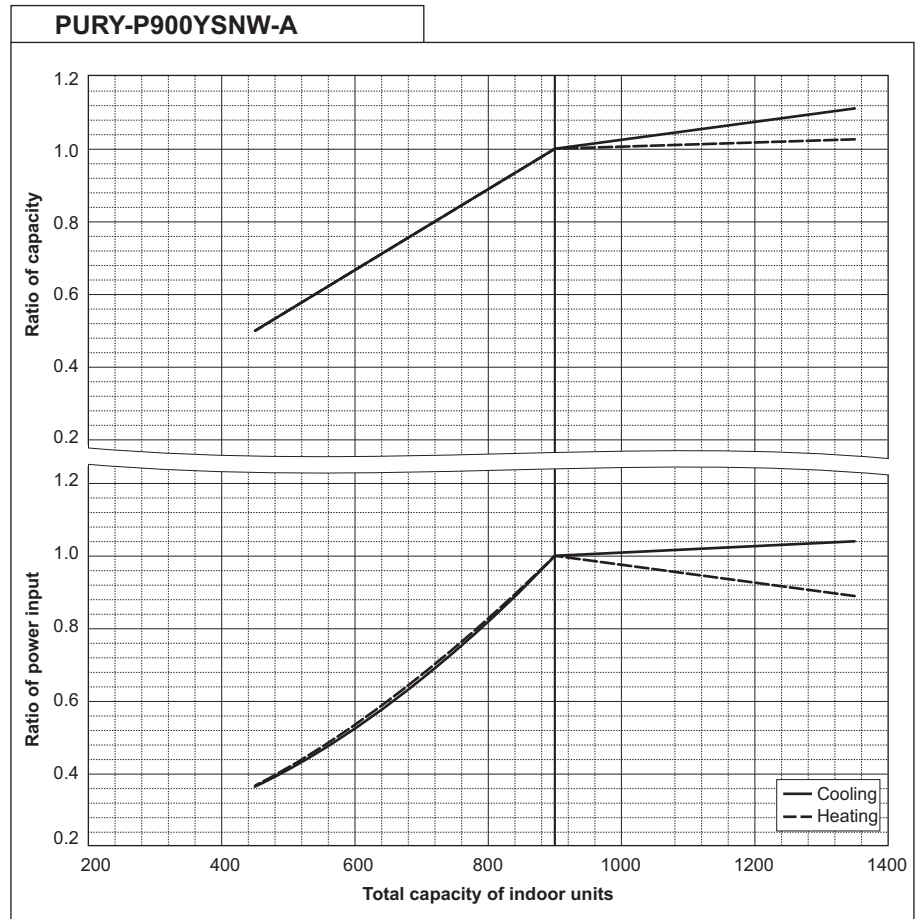

PURY-P950YSNW-A		
Cooling Capacity	kW	108.0
	BTU/h	368,500
Input	kW	26.40

PURY-P950YSNW-A		
Heating Capacity	kW	119.5
	BTU/h	407,700
Input	kW	29.79

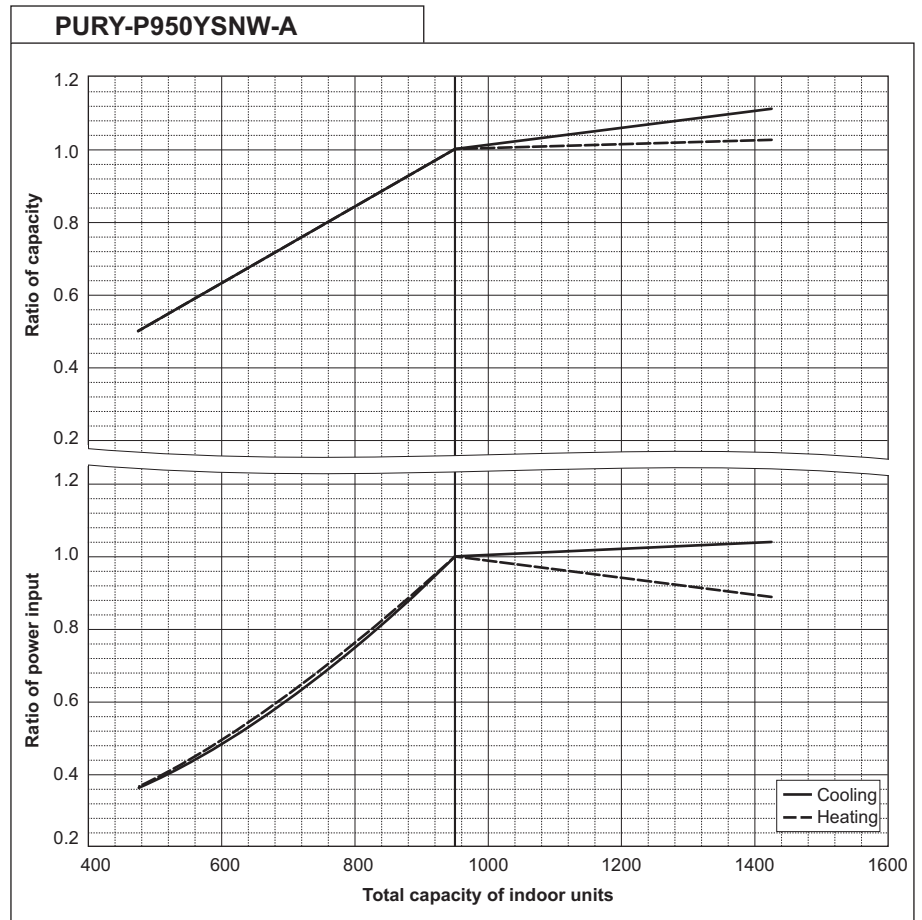

PURY-P-Y(S)NW-A

8. CAPACITY TABLES

Outdoor units

PURY-P-Y(S)NW-A

PURY-P1000YSNW-A		
Cooling Capacity	kW	113.0
	BTU/h	385,600
Input	kW	26.45

PURY-P1000YSNW-A		
Heating Capacity	kW	127.0
	BTU/h	433,300
Input	kW	31.74

PURY-P1000YSNW-A

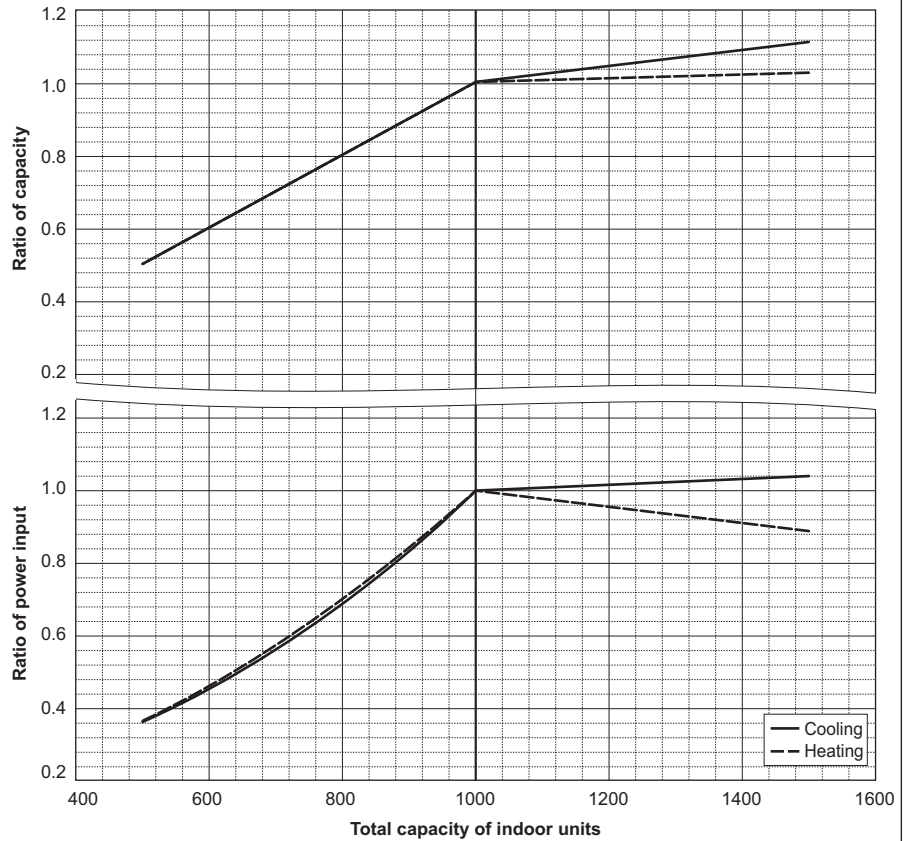

PURY-P1050YSNW-A		
Cooling Capacity	kW	118.0
	BTU/h	402,600
Input	kW	29.20

PURY-P1050YSNW-A		
Heating Capacity	kW	132.0
	BTU/h	450,400
Input	kW	34.10

PURY-P1050YSNW-A

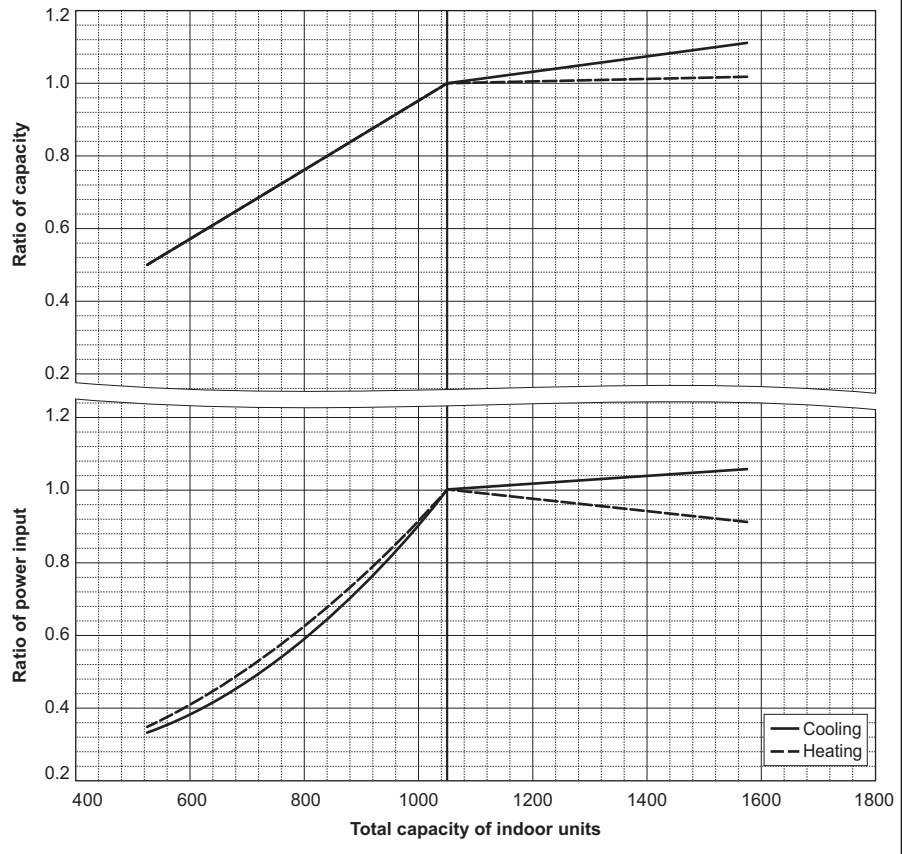

8. CAPACITY TABLES

Outdoor units

PURY-P1100YSNW-A		
Cooling Capacity	kW	124.0
	BTU/h	423,100
Input	kW	32.54

PURY-P1100YSNW-A		
Heating Capacity	kW	140.0
	BTU/h	477,700
Input	kW	37.52

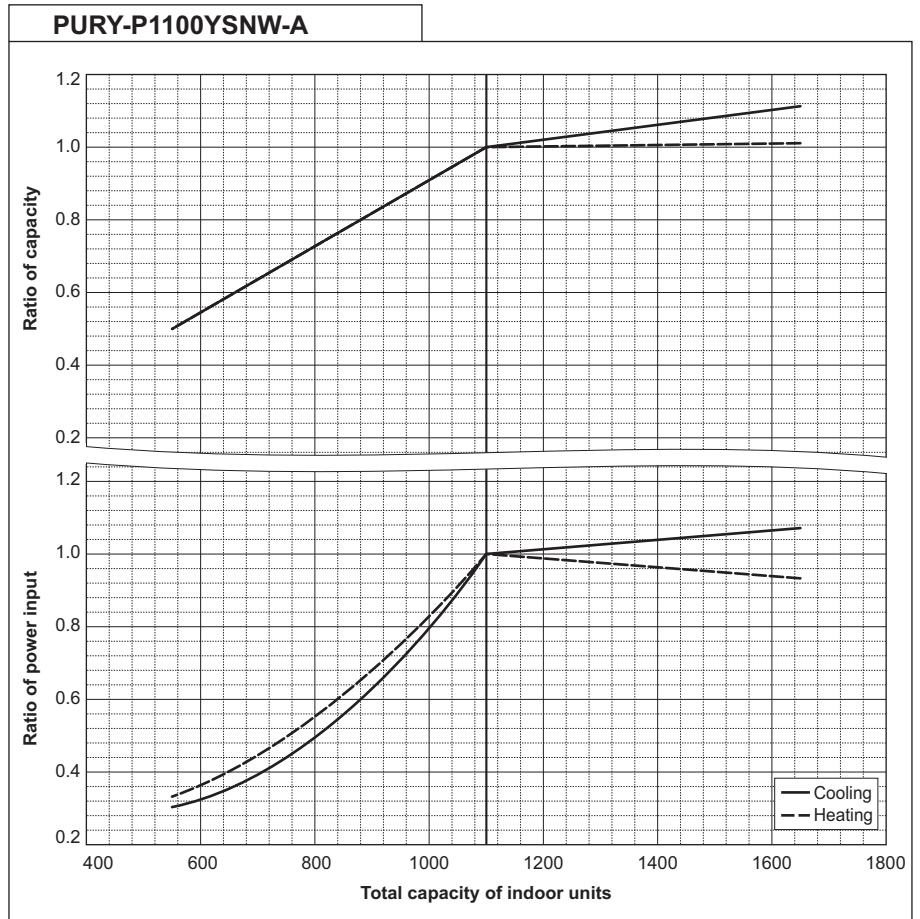

PURY-P-Y(S)NW-A

8-4. Correction by refrigerant piping length

CITY MULTI system can extend the piping flexibly within its limitation for the actual situation. However, a decrease of cooling/heating capacity could happen correspondently. Using following correction factor according to the equivalent length of the piping shown at 8-4-1 and 8-4-2, the capacity can be observed. 8-4-3 shows how to obtain the equivalent length of piping.

8-4-1. Cooling capacity correction

PURY-P-Y(S)NW-A

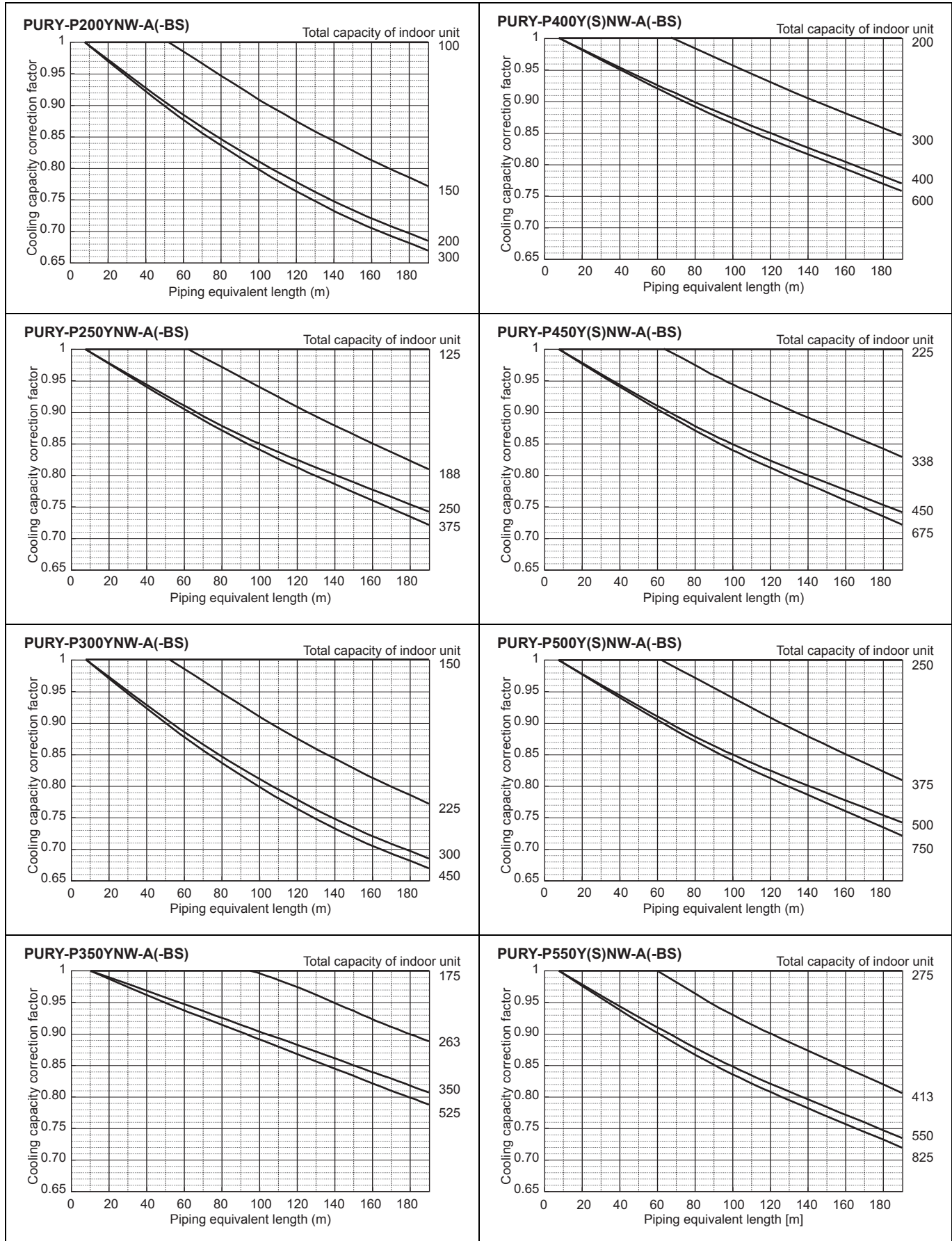

8. CAPACITY TABLES

Outdoor units

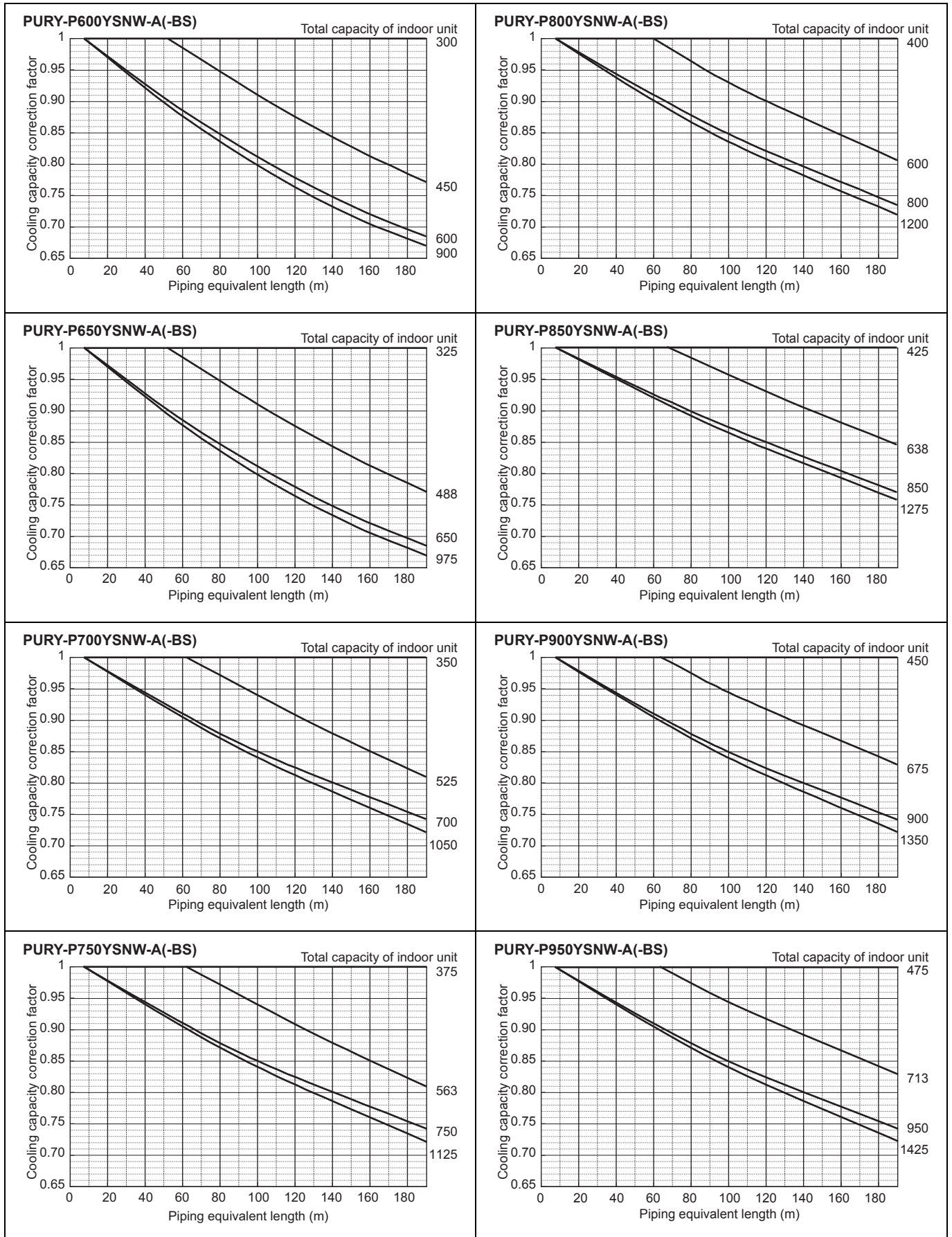

PURY-P-Y(S)NW-A

8. CAPACITY TABLES

PURY-P-Y(S)NW-A

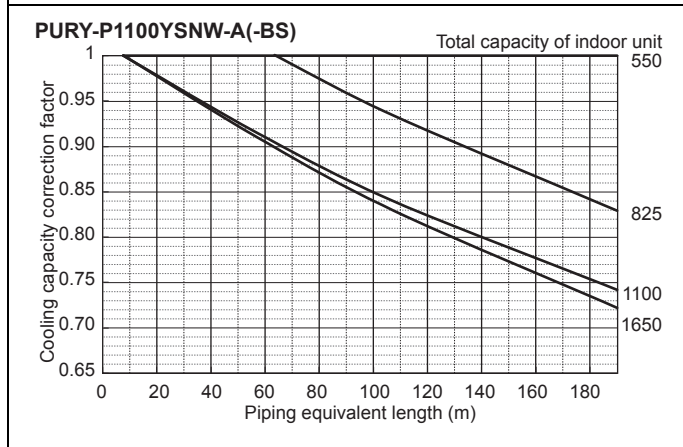
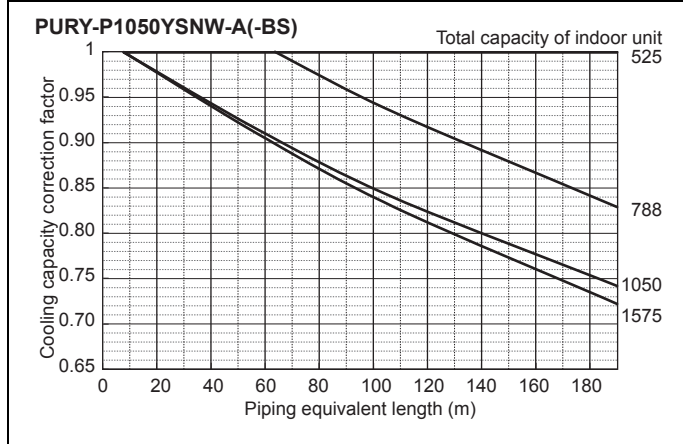
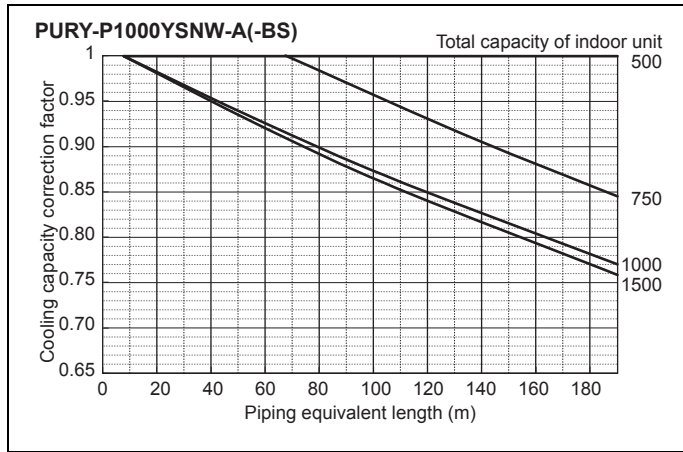

8-4-2. Heating capacity correction

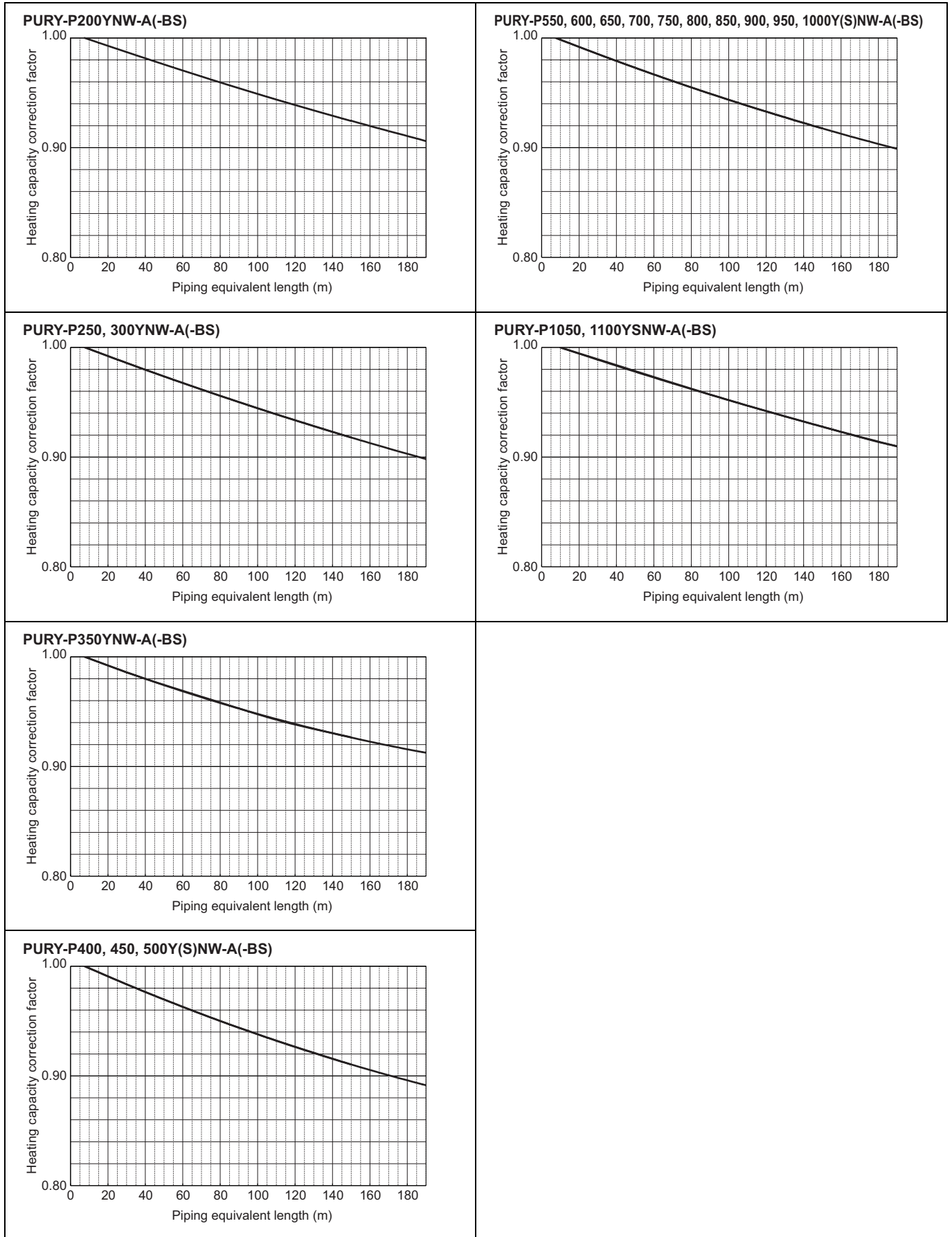

8-4-3. How to obtain the equivalent piping length

- 1 **PURY-P200YNW-A(-BS)**
Equivalent length = (Actual piping length to the farthest indoor unit) + (0.35 x number of bends in the piping) m
- 2 **PURY-P250, 300YNW-A(-BS)**
Equivalent length = (Actual piping length to the farthest indoor unit) + (0.42 x number of bends in the piping) m
- 3 **PURY-P350YNW-A(-BS)**
Equivalent length = (Actual piping length to the farthest indoor unit) + (0.47 x number of bends in the piping) m
- 4 **PURY-P400, 450, 500, 550, 600, 650Y(S)NW-A(-BS)**
Equivalent length = (Actual piping length to the farthest indoor unit) + (0.50 x number of bends in the piping) m
- 5 **PURY-P700, 750, 800YSNW-A(-BS)**
Equivalent length = (Actual piping length to the farthest indoor unit) + (0.70 x number of bends in the piping) m
- 6 **PURY-P850, 900, 950, 1000, 1050, 1100YSNW-A(-BS)**
Equivalent length = (Actual piping length to the farthest indoor unit) + (0.80 x number of bends in the piping) m

8-5. Correction by port counts of the BC controller

Indoor unit sizes P200 and P250 must be connected to 2 ports on the BC controller.

Indoor unit sizes from P100 to P140 should normally be connected to 2 ports on the BC controller (set BC controller DIP-SW 4-6 to its ON position).

In cases whereby indoor unit sizes from P100 to P140 or total capacity indoor units from P81 to P140 are connected to only 1 port on the BC controller (set BC controller DIP-SW 4-6 to its OFF position), the cooling capacity of the indoor unit should be multiplied by a correction factor of **0.97**.

8-6. Correction at frost and defrost

Due to frost at the outdoor heat exchanger and the automatic defrost operation, the heating capacity of the outdoor unit can be calculated by multiplying the correction factor shown in the table below.

Table of correction factor at frosting and defrosting

Outdoor inlet air temp. °CWB	6	4	2	1	0	-2	-4	-6	-8	-10	-20
Outdoor inlet air temp. °FWB	43	39	36	34	32	28	25	21	18	14	-4
PURY-P200YNW-A(-BS)	1.00	0.95	0.84	0.83	0.83	0.87	0.90	0.95	0.95	0.95	0.95
PURY-P250YNW-A(-BS)	1.00	0.95	0.84	0.83	0.83	0.87	0.90	0.95	0.95	0.95	0.95
PURY-P300YNW-A(-BS)	1.00	0.93	0.82	0.80	0.82	0.86	0.90	0.90	0.95	0.95	0.95
PURY-P350YNW-A(-BS)	1.00	0.93	0.85	0.83	0.84	0.86	0.90	0.90	0.95	0.95	0.95
PURY-P400Y(S)NW-A(-BS)	1.00	0.95	0.90	0.87	0.88	0.89	0.90	0.95	0.95	0.95	0.95
PURY-P450Y(S)NW-A(-BS)	1.00	0.98	0.89	0.87	0.89	0.90	0.92	0.95	0.95	0.95	0.95
PURY-P500Y(S)NW-A(-BS)	1.00	0.98	0.89	0.86	0.89	0.90	0.92	0.95	0.95	0.95	0.95
PURY-P550Y(S)NW-A(-BS)	1.00	0.94	0.87	0.86	0.87	0.88	0.90	0.90	0.93	0.93	0.93
PURY-P600YSNW-A(-BS)	1.00	0.94	0.84	0.86	0.87	0.88	0.90	0.90	0.93	0.93	0.93
PURY-P650YSNW-A(-BS)	1.00	0.94	0.84	0.86	0.87	0.88	0.90	0.90	0.93	0.93	0.93
PURY-P700YSNW-A(-BS)	1.00	0.98	0.89	0.88	0.89	0.90	0.92	0.95	0.95	0.95	0.95
PURY-P750YSNW-A(-BS)	1.00	0.98	0.89	0.88	0.89	0.90	0.92	0.95	0.95	0.95	0.95
PURY-P800YSNW-A(-BS)	1.00	0.98	0.89	0.88	0.89	0.90	0.92	0.95	0.95	0.95	0.95
PURY-P850YSNW-A(-BS)	1.00	0.98	0.89	0.88	0.89	0.90	0.92	0.95	0.95	0.95	0.95
PURY-P900YSNW-A(-BS)	1.00	0.98	0.89	0.88	0.89	0.90	0.92	0.95	0.95	0.95	0.95
PURY-P950YSNW-A(-BS)	1.00	0.98	0.89	0.87	0.89	0.90	0.92	0.95	0.95	0.95	0.95
PURY-P1000YSNW-A(-BS)	1.00	0.98	0.89	0.86	0.89	0.90	0.92	0.95	0.95	0.95	0.95
PURY-P1050YSNW-A(-BS)	1.00	0.96	0.88	0.86	0.88	0.89	0.91	0.93	0.94	0.94	0.94
PURY-P1100YSNW-A(-BS)	1.00	0.94	0.87	0.86	0.87	0.88	0.90	0.90	0.93	0.93	0.93

8-7. Correction at evaporation-temperature (ET) control

When the target evaporation temperature is changed, the capacity or the power input can be calculated by multiplying the correction factor shown in the table below.

ET *1	°C	6	9	11	14
Correction factor	Capacity	0.90	0.83	0.71	0.55
	Power Input	0.90	0.72	0.54	0.36

*1 The evaporation temperature in operation may be different from the preset target evaporation temperature because it depends on such factors as the unit protection control.

The capacity and power input could also fluctuate.

*2 Use the table above which indicates the unit properties as a reference

9-1. JOINT and REDUCER

CITY MULTI units can be easily connected by using Joint sets and Reducer sets provided by Mitsubishi Electric. Refer to section "Piping Design" or the Installation Manual that comes with the Joint set or Reducer set for how to install the Joint set or Reducer set.

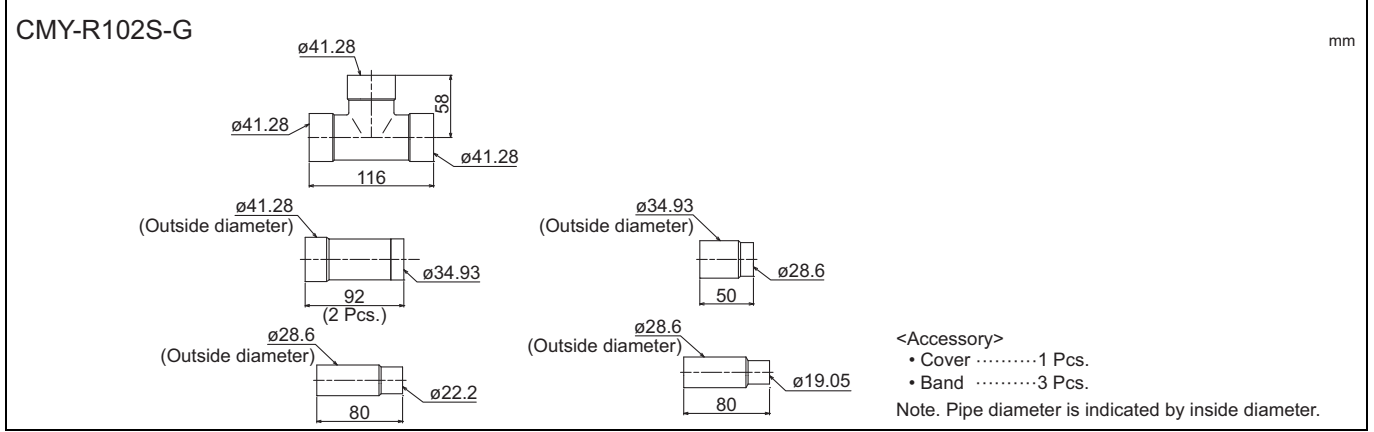
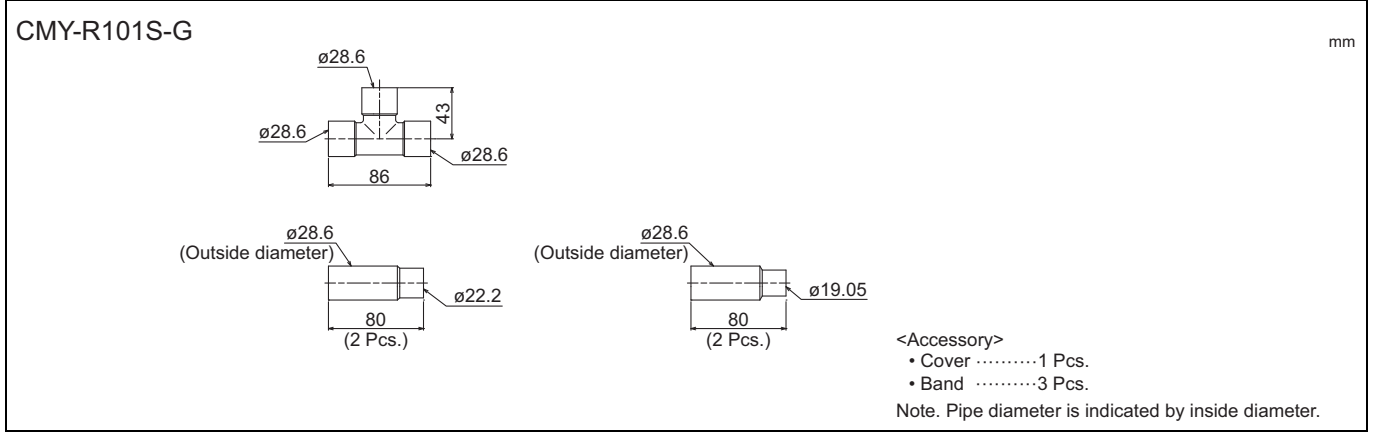
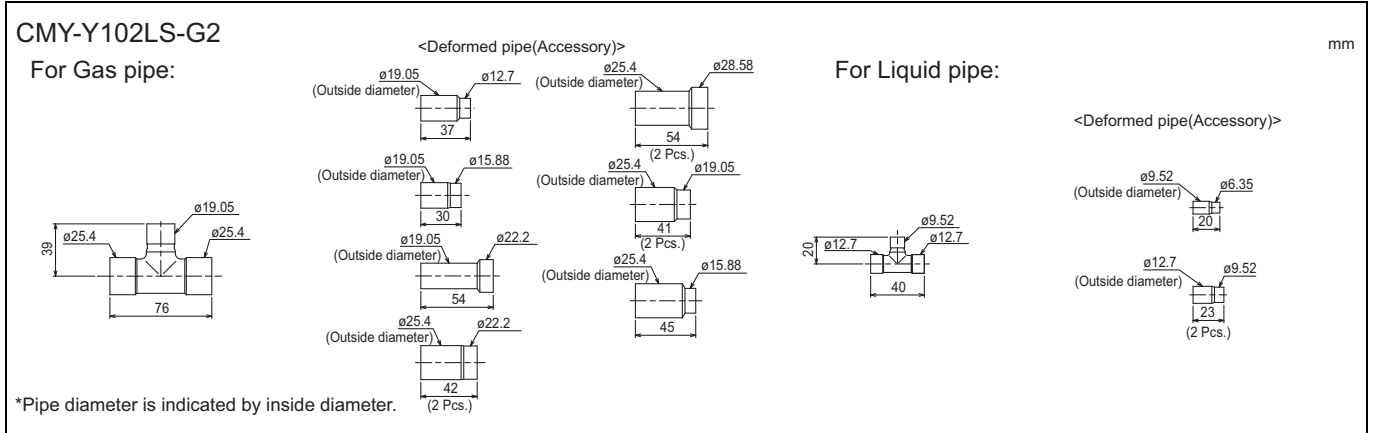
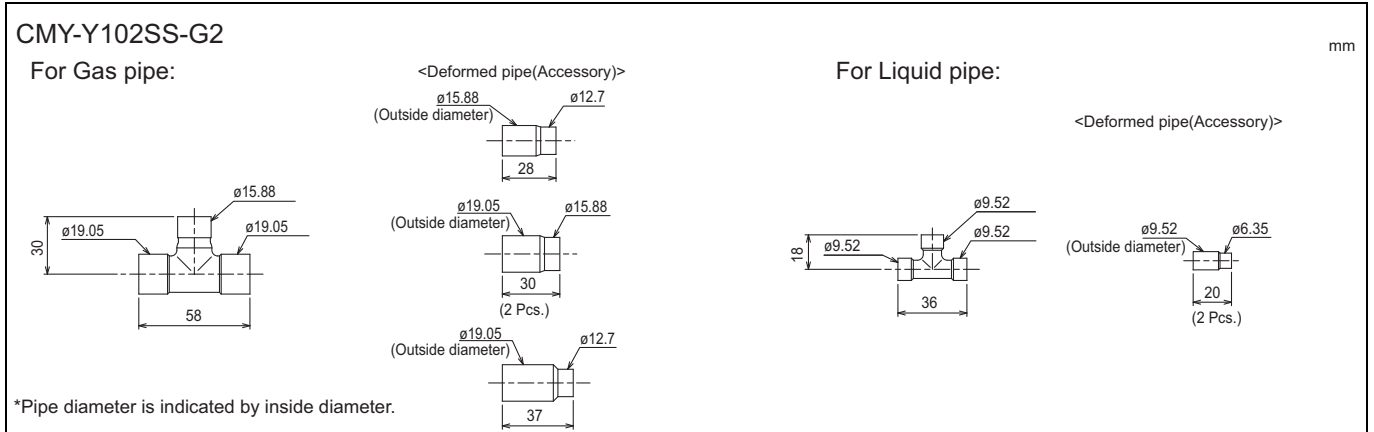

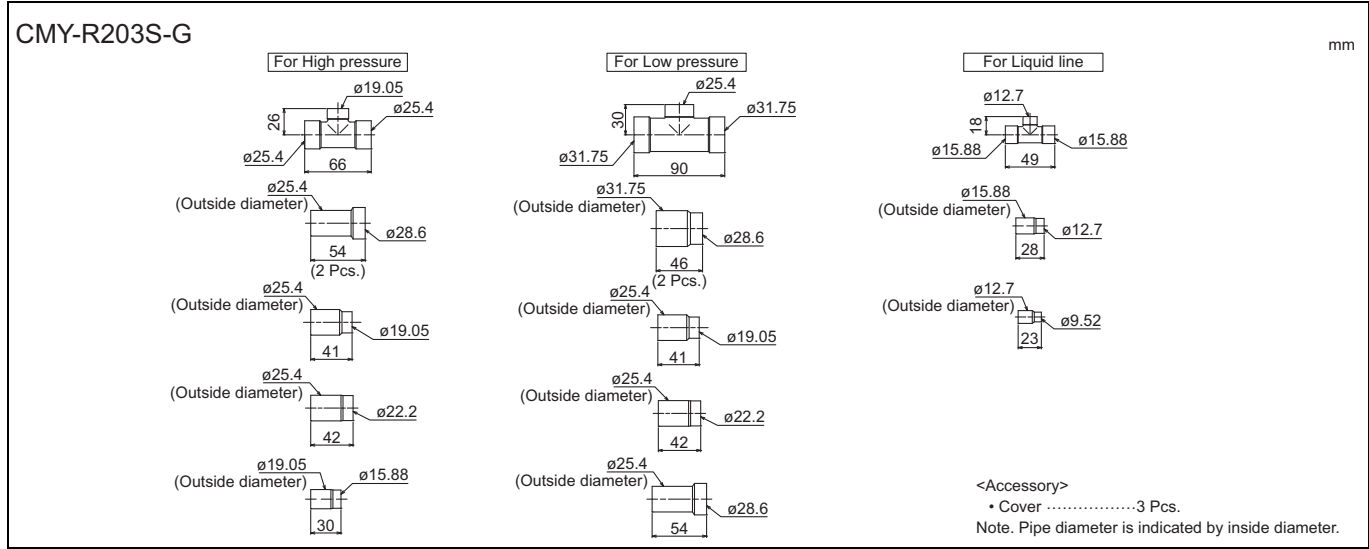
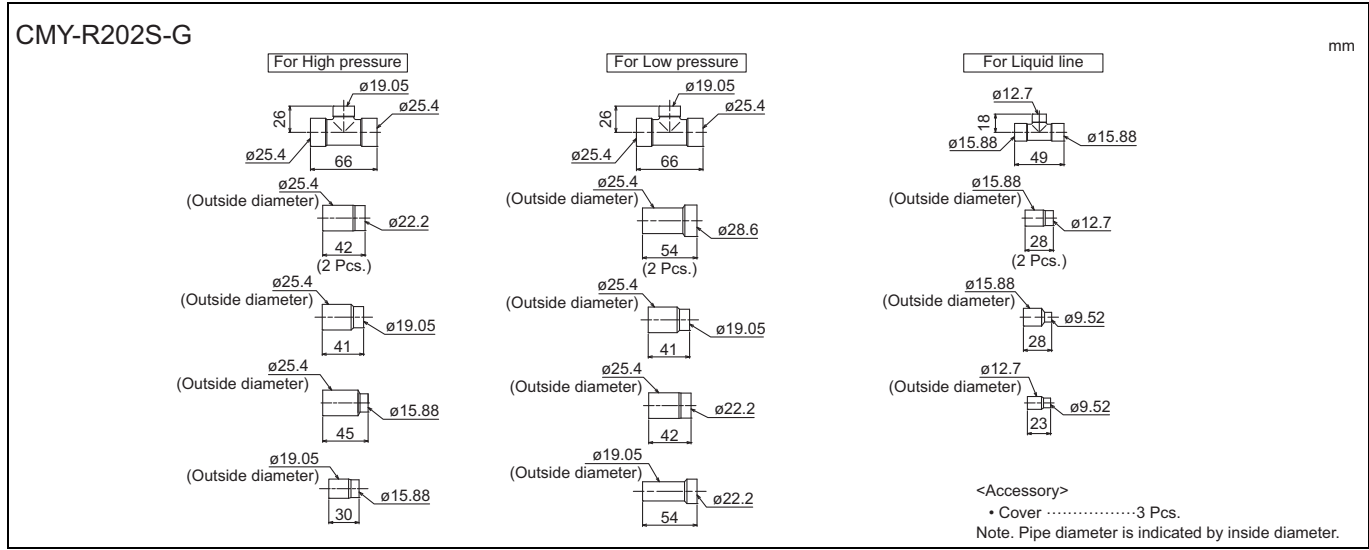
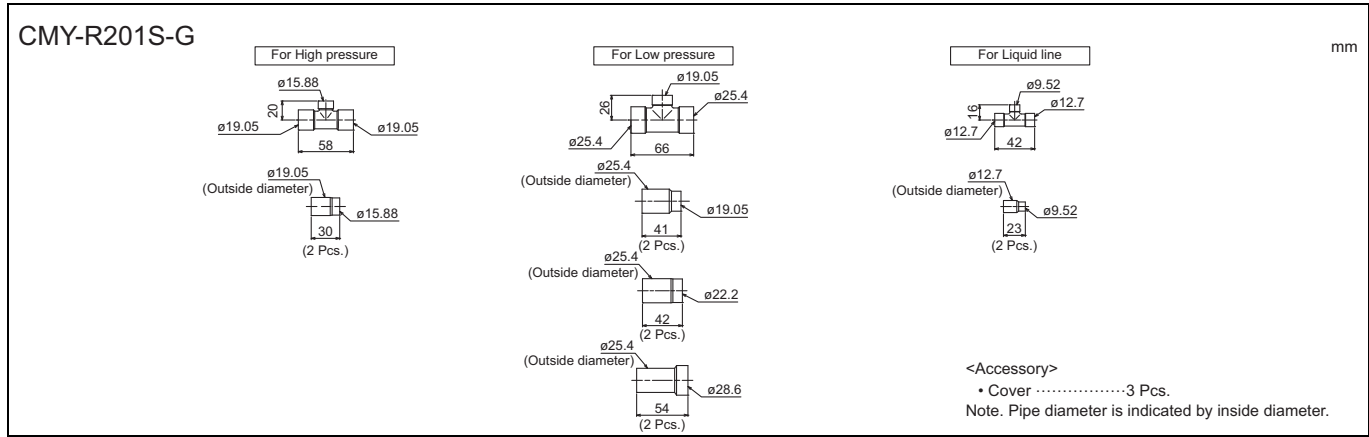

PUY-P-Y(S)NW-A

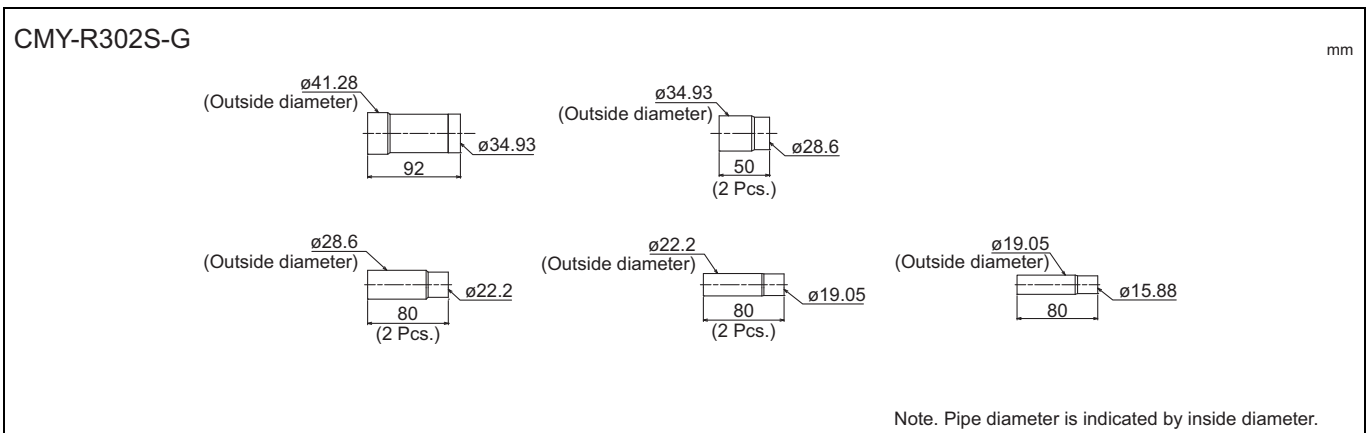
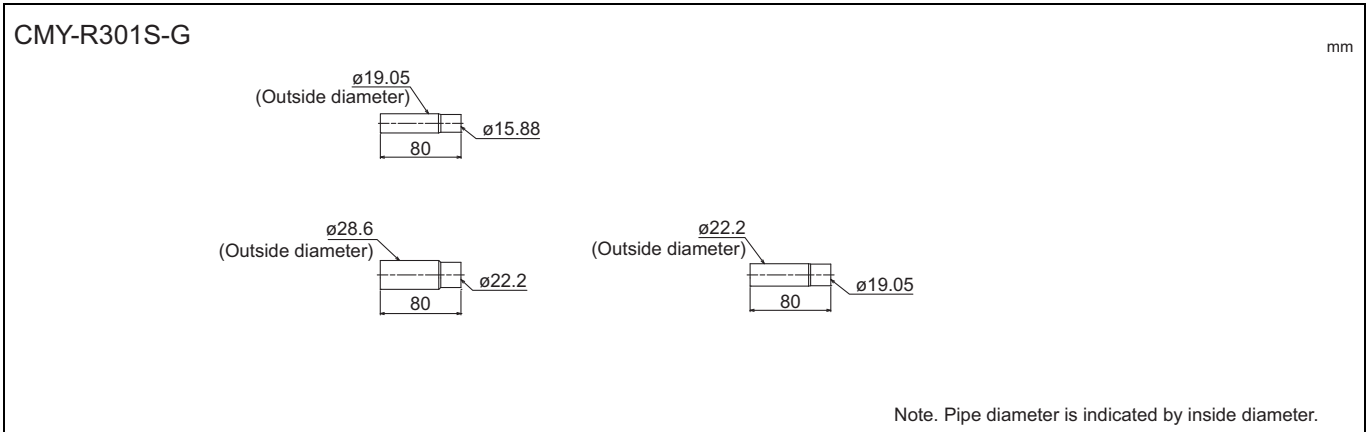
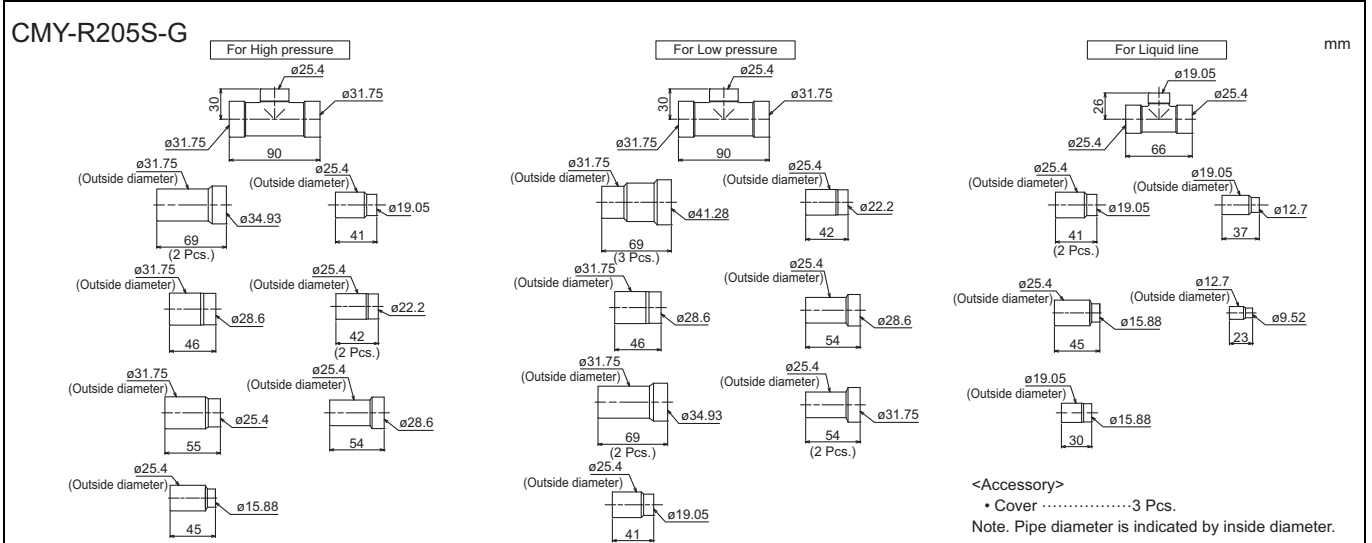
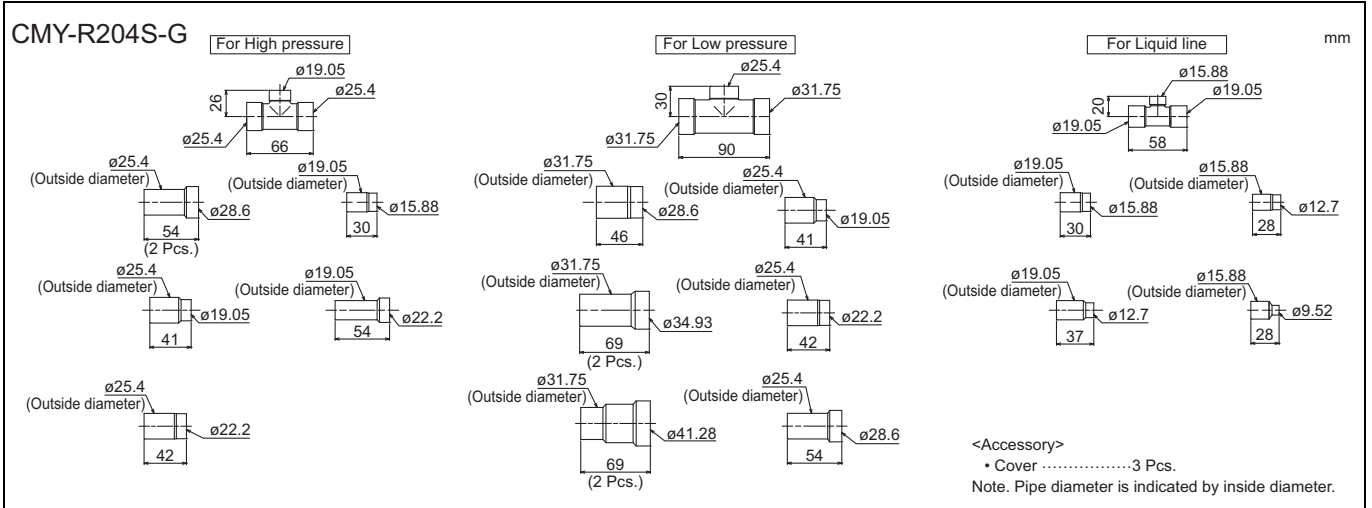

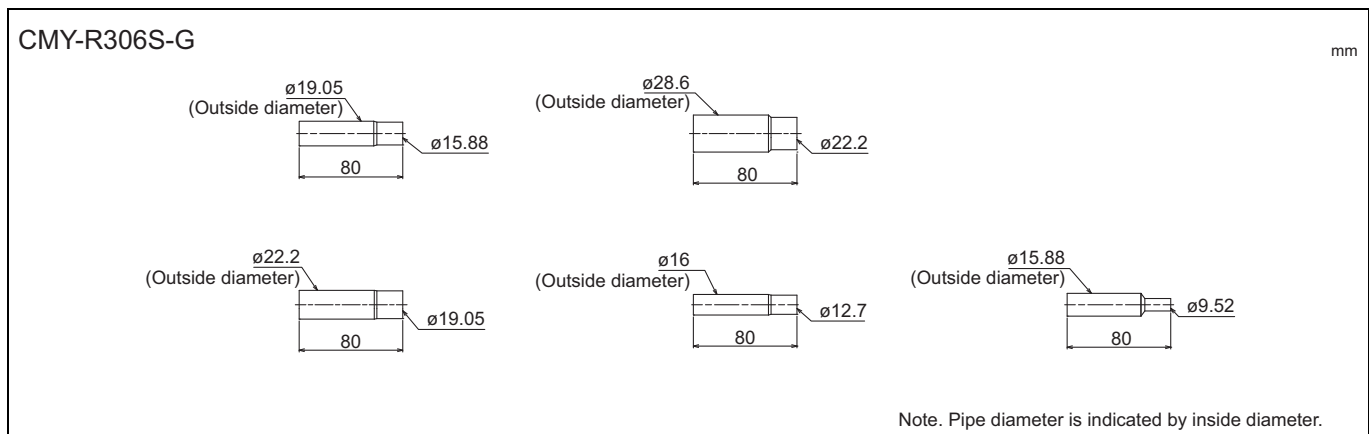
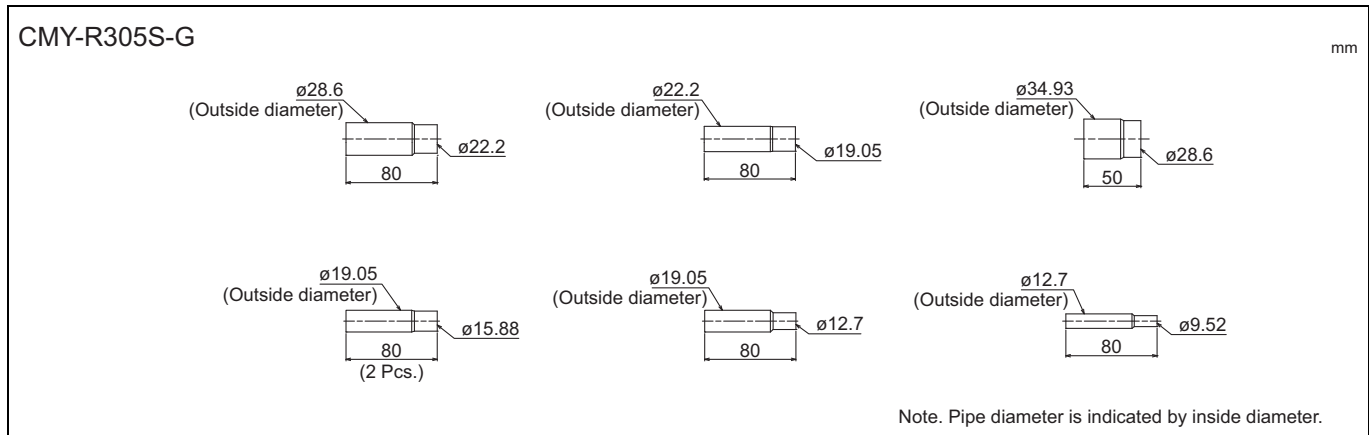
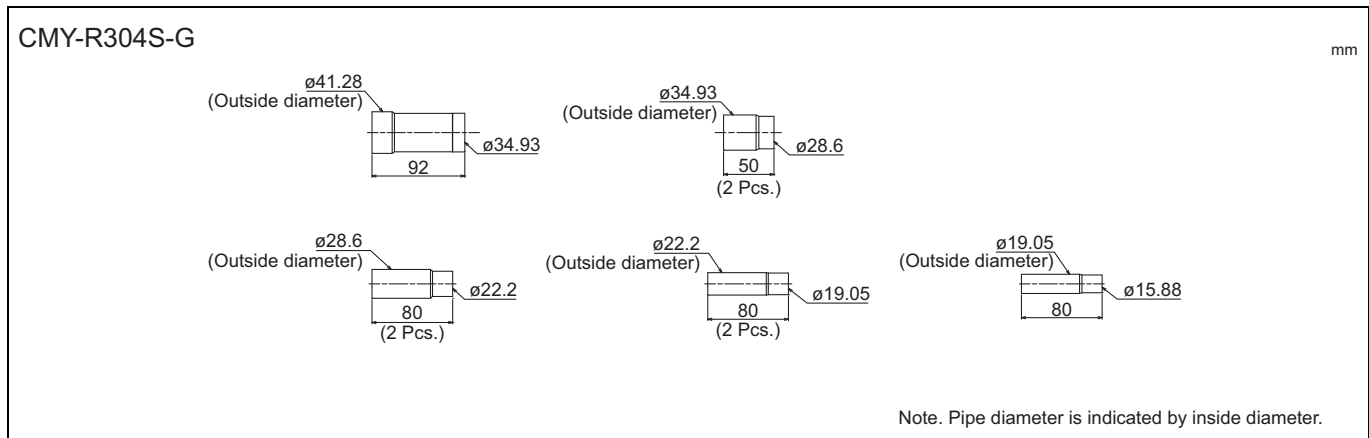
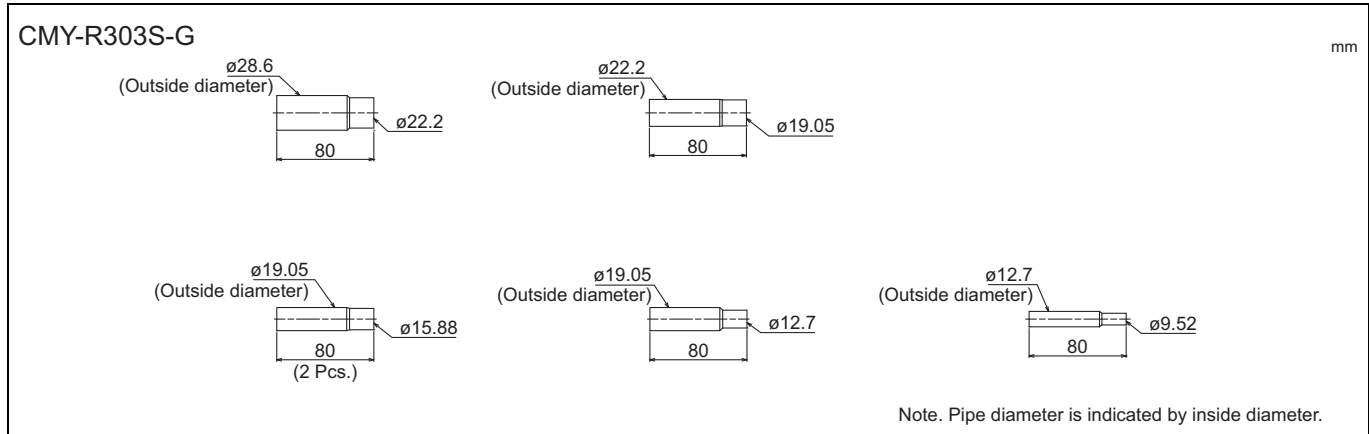

PUY-P-Y(S)NW-A

9-2. OUTDOOR TWINNING KIT

The following optional Outdoor Twinning Kit is needed to use to combine multiple refrigerant pipes. Refer to section "Piping Design" for the details of selecting a proper twinning kit.

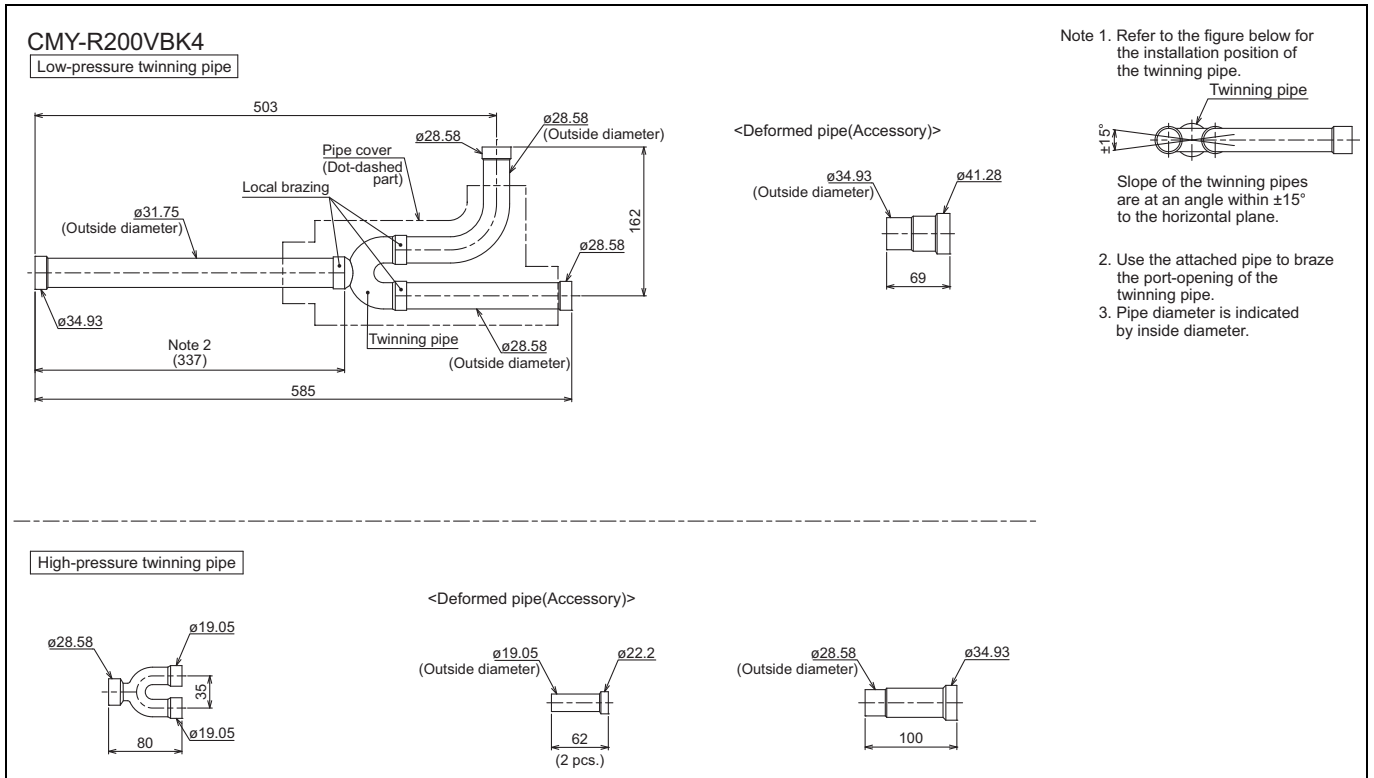
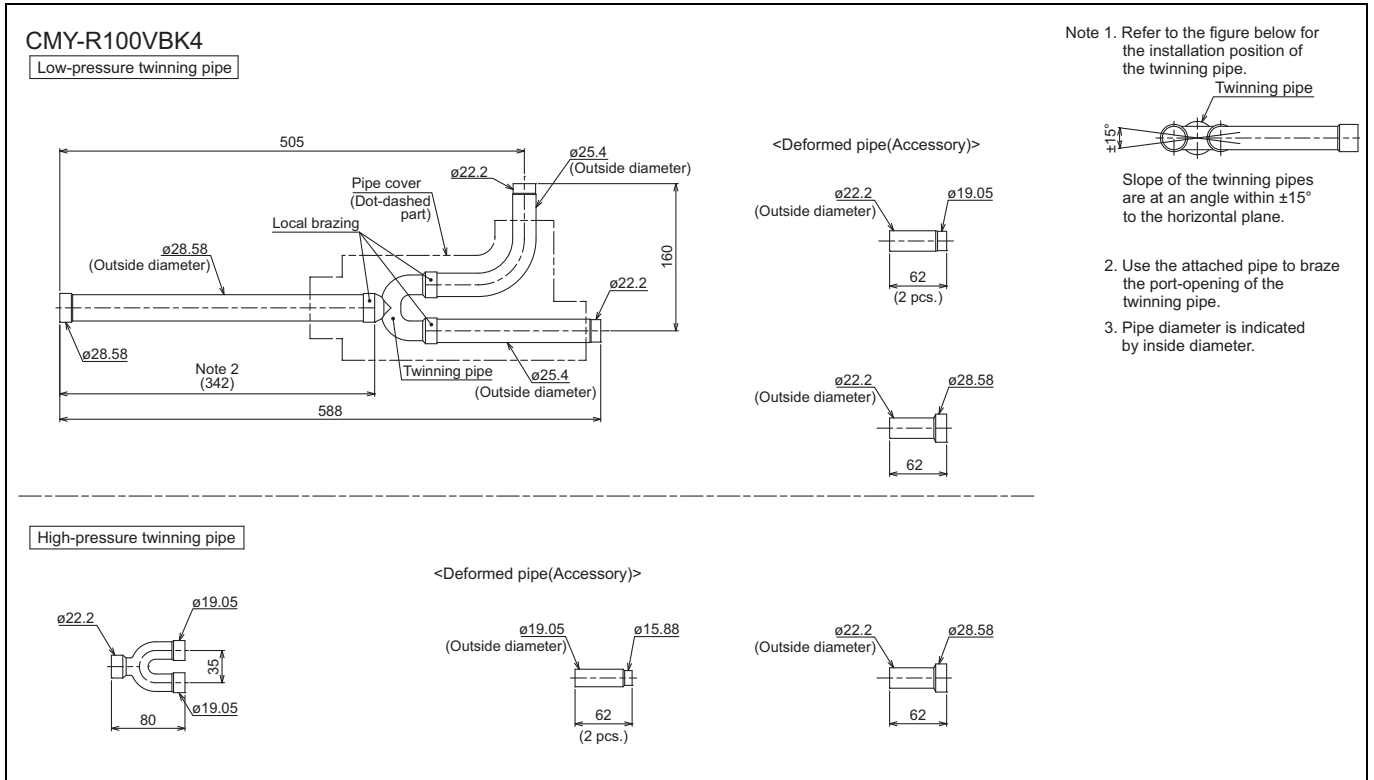

Note 1. Refer to the figure below for the installation position of the twinning pipe.

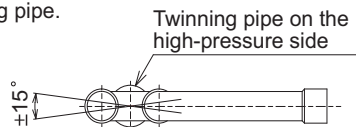

Slope of the twinning pipe is at an angle within $\pm 15^\circ$ to the horizontal plane.

2. Use the attached pipe to braze the port-opening of the distributor.
3. Pipe diameter is indicated by inside diameter.
4. Only use the Twinning pipe by Mitsubishi (optional parts).

9-3. JOINT KIT "CMY-R160-J1" FOR BC CONTROLLER

Joint kit "CMY-R160-J1" for BC controller is used to combine 2 ports of the BC controller at a PURY/PQRY system so as to enable down-stream Indoor capacity above P80 as shown in Fig. 1.

The Joint kit include following items:

① Instruction	② Joint pipe(Small)	③ Joint pipe(Large)	④ Cover 1	⑤ Cover 2	⑥ Cover 3	⑦ Band	⑧ Reducer 1	⑨ Reducer 2
This sheet 1pc	1pc	1pc	2pcs	1pc for gas side	1pc for liquid side	8pcs	OD19.05-ID22.2 1pc	OD19.05-ID15.88 1pc

Please prepare the following items in the field. ①Tape for insulation material sealing ②Extension pipe for refrigerant circuit

② Joint pipe (for liquid side)

③ Joint pipe (for gas side)

mm (in.)

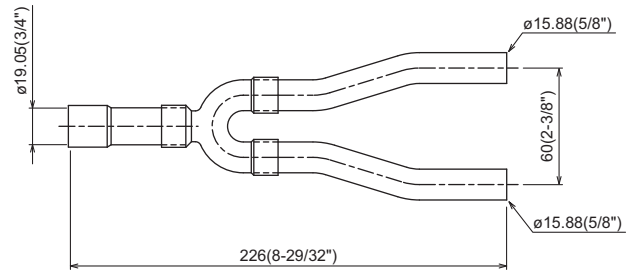
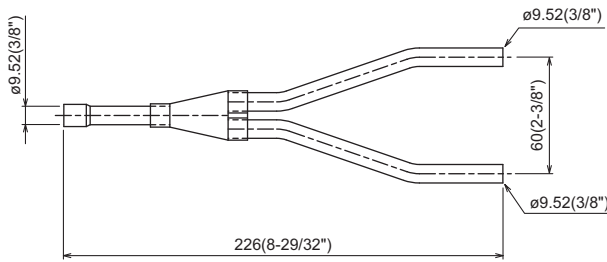

PURY-P-Y(S)NW-A

1. Designing CMY-R160-J1 to a PURY/PQRY system

The maximum down-stream Indoor capacity for 1 port of BC controller is P80. When the down-stream Indoor capacity is above P80, Joint kit CMY-R160-J1 is needed to combined 2 ports of BC controller to enlarge the capacity, like Group 2 and 3 in Fig. 1.

Maximum 3 Indoor units are allowed to connect to 1 port of BC controller or 2 combined ports of BC controller using CMY-R160-J1.

When connecting Indoor units to 1 port of BC controller or 2 combined ports of BC controller using CMY-R160-J1 or CMY-Y102SS-G2 is applicable, like Group 1 and 2 in Fig. 1

Caution: Mixed cooling and heating mode at the same time for Indoor units connecting to 1 port or 2 combined ports is not available.

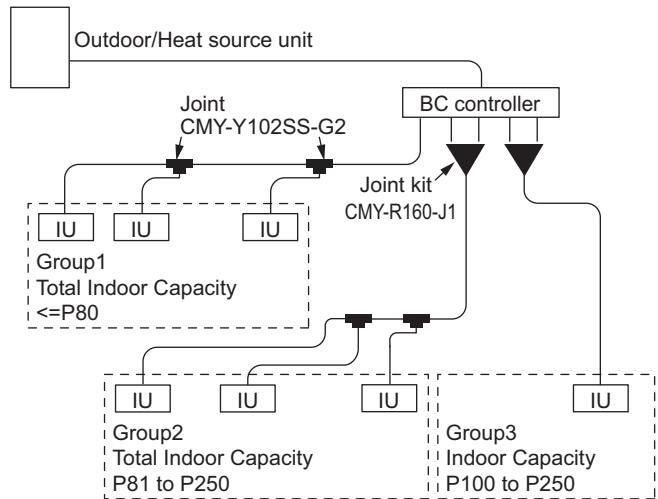

Fig.1. CMY-R160-J1 applying scheme

2. Piping at the installation site

The connection of CMY-R160-J1 to BC controller and pipe leading to Indoor units is referable to Fig. 2. Non-oxidized brazing is necessary. All piping must be careful to avoid foreign material getting inside.

After piping and air-tight testing, insulation work to the Joint and pipe should be done. Details is available at the Installation Manual.

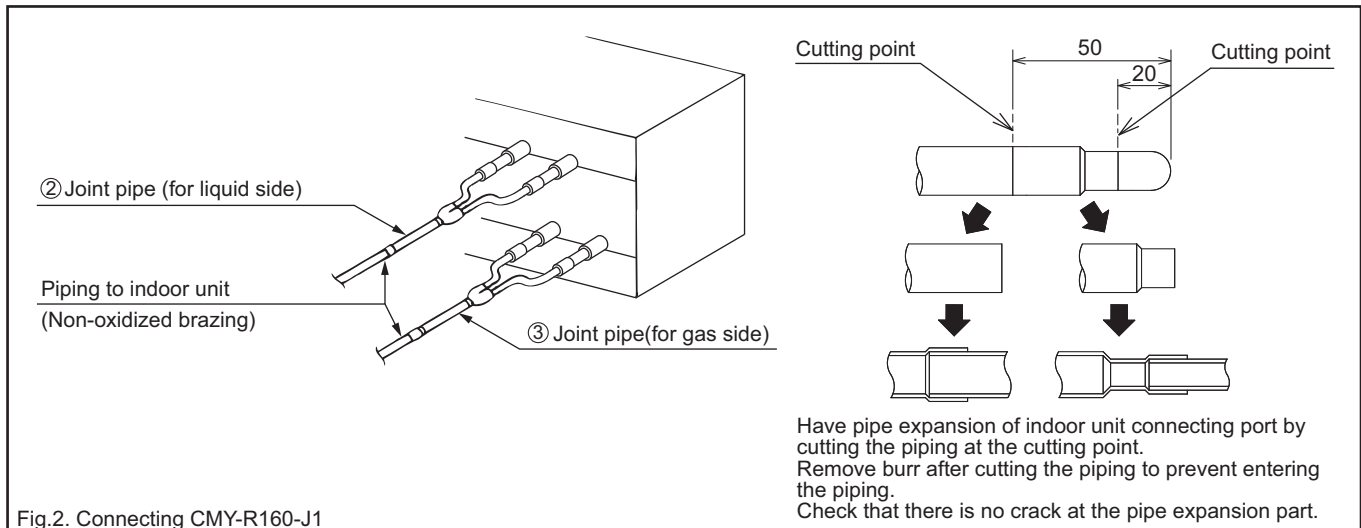
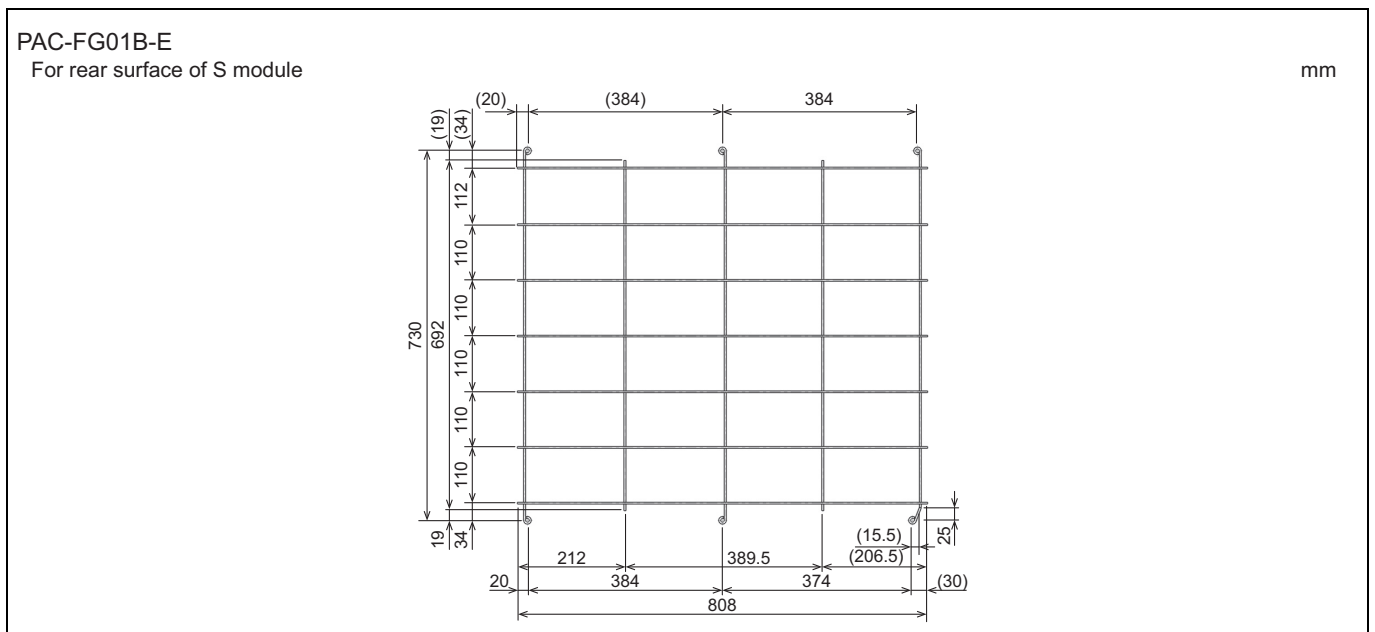
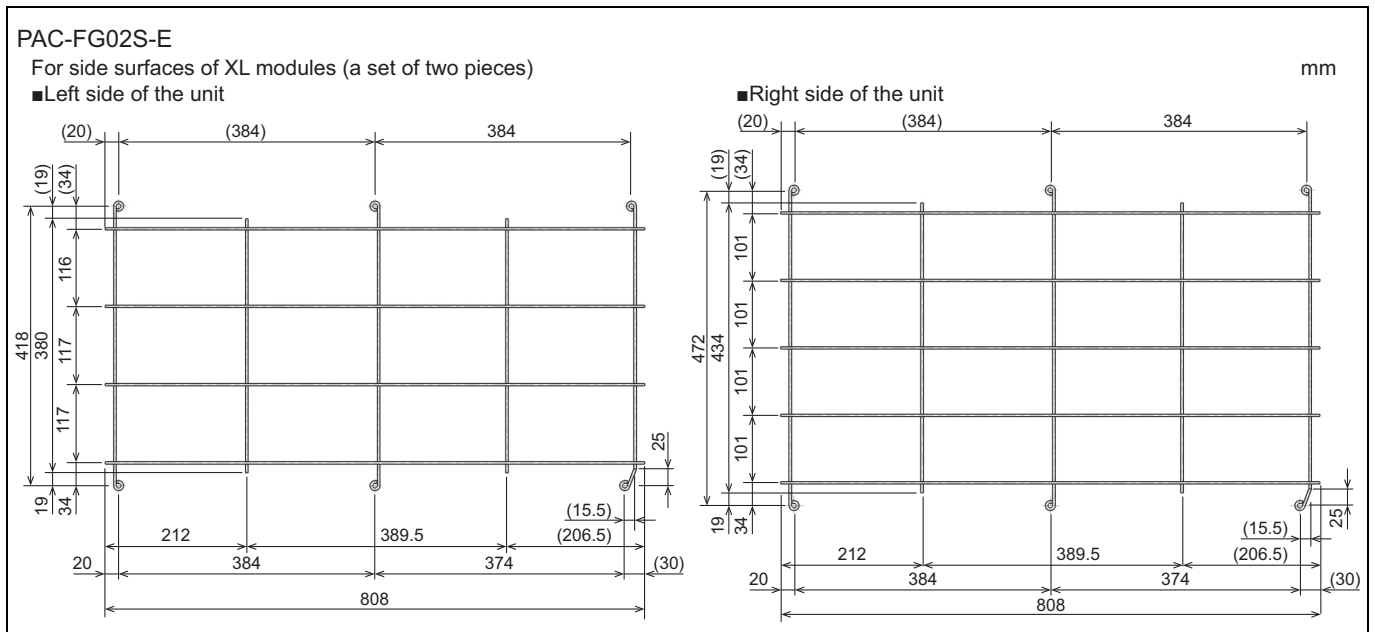
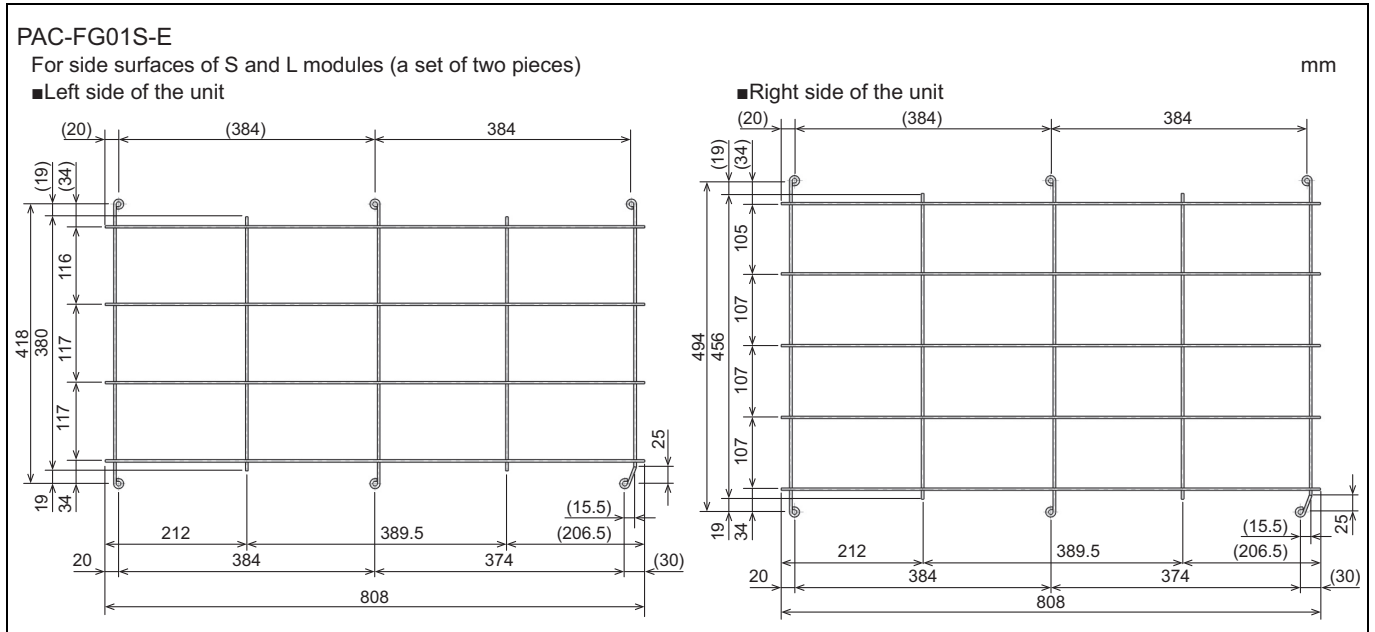

Fig.2. Connecting CMY-R160-J1

9-4. FIN GUARD



9. OPTIONAL PARTS

Outdoor units

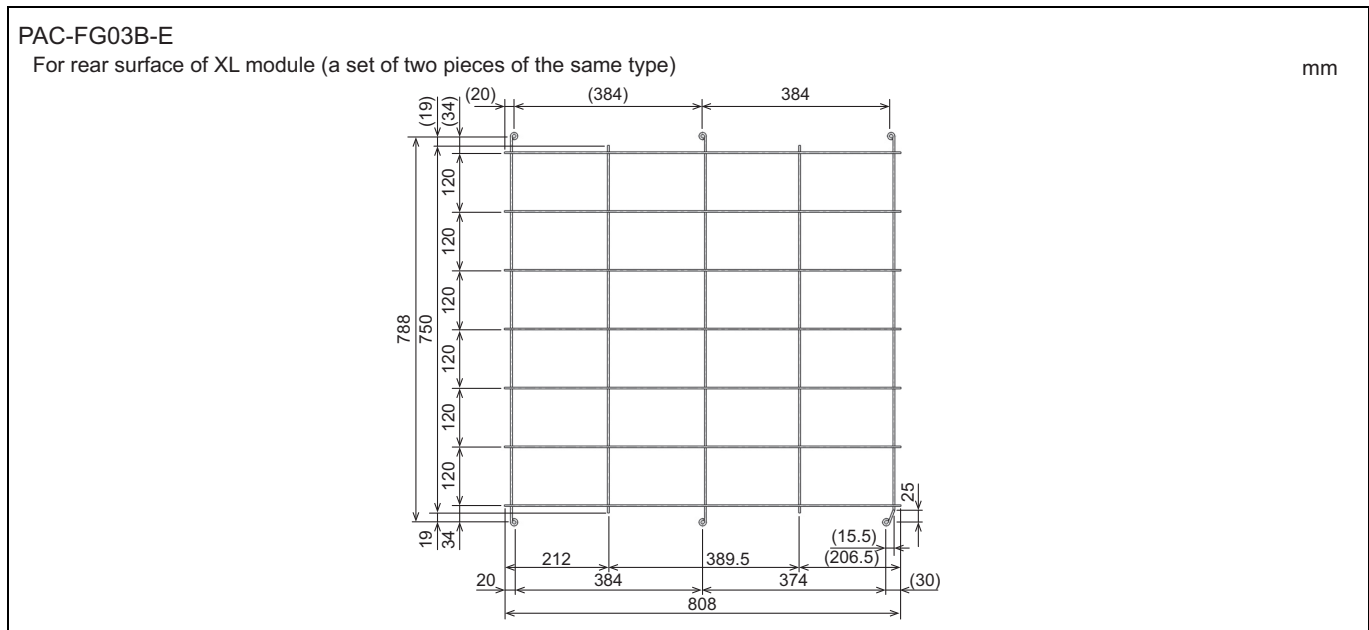
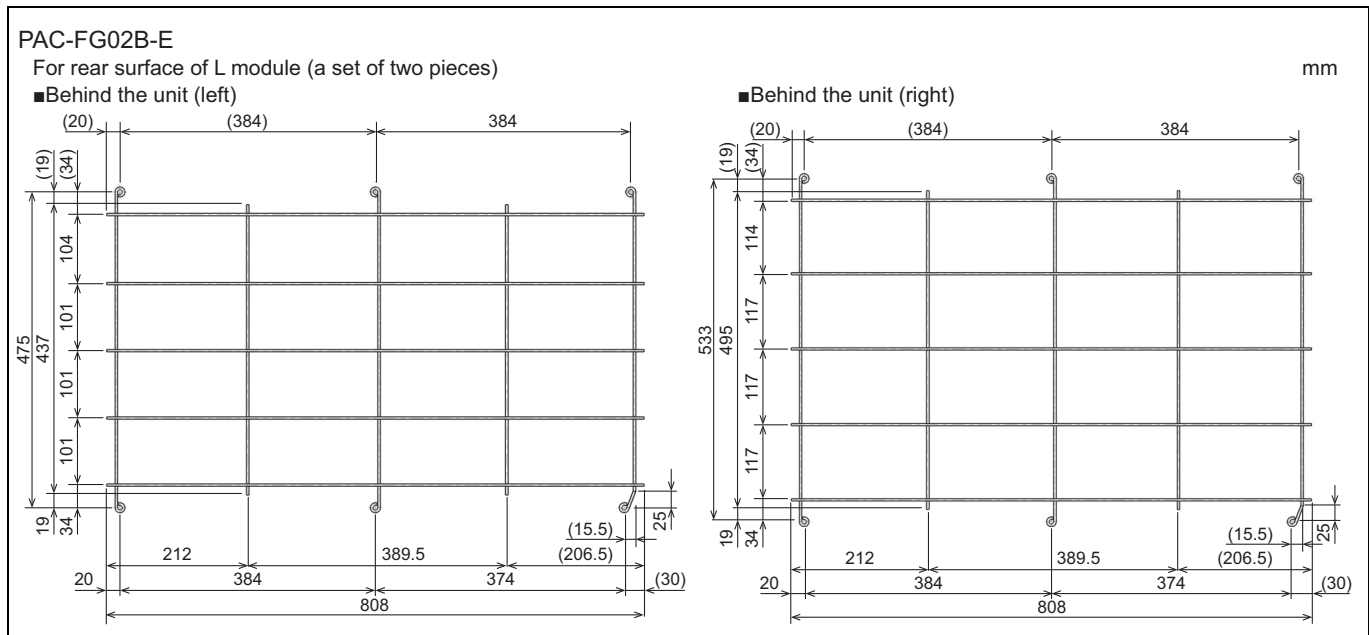

PURY-P-Y(S)NW-A

10-1. General cautions

- ① Follow ordinance of your governmental organization for technical standard related to electrical equipment, wiring regulations, and guidance of each electric power company.
- ② Wiring for control (hereinafter referred to as transmission cable) shall be (50mm[1-5/8in.] or more) apart from power source wiring so that it is not influenced by electric noise from power source wiring. (Do not insert transmission cable and power source wire in the same conduit.)
- ③ Be sure to provide designated grounding work to outdoor unit.
- ④ Give some allowance to wiring for electrical part box of indoor and outdoor units, because the box is sometimes removed at the time of service work.
- ⑤ Never connect 380~415V(220~240V) power source to terminal block of transmission cable. If connected, electrical parts will be damaged.
- ⑥ Use 2-core shield cable for transmission cable. If transmission cables of different systems are wired with the same multiple-core cable, the resultant poor transmitting and receiving will cause erroneous operations.
- ⑦ When extending the transmission line, make sure to extend the shield cable as well.

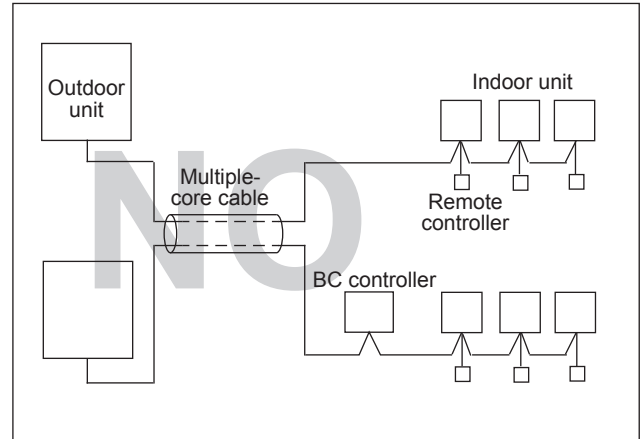
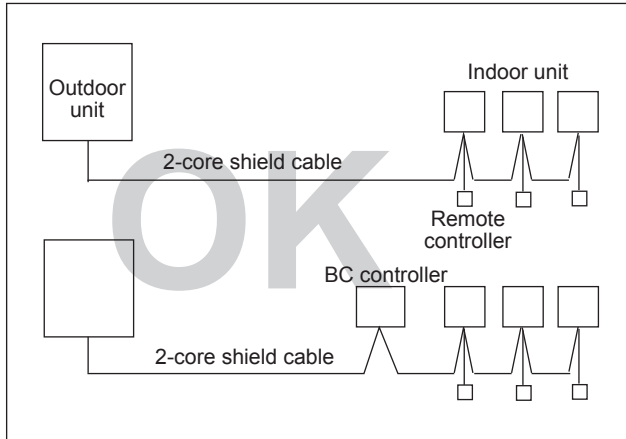

10-2. Power supply for Outdoor unit

10-2-1. Electrical characteristics of Outdoor unit at cooling mode

Symbols: MCA (Max Circuit Amps)

RLA (Rated Load Amps) SC (Starting Current)

PURY-P-YNW-A	Unit Combination	Units			Power supply	Compressor		FAN	RLA(A)(50/60Hz)				
		Hz	Volts	Voltage range	MCA(A)	Output (kW)	SC(A)	Output(kW)	Cooling	Heating			
PURY-P200YNW-A(-BS)	-	50/60	380 400 415	Max:456V Min:342V	16.1	5.6	8	0.92	7.4/7.1/6.8	7.9/7.5/7.2			
PURY-P250YNW-A(-BS)	-				17.8	7.0	8	0.92	10.0/9.5/9.2	10.2/9.7/9.3			
PURY-P300YNW-A(-BS)	-				22.7	7.9	8	0.92	12.7/12.0/11.6	14.1/13.4/12.9			
PURY-P350YNW-A(-BS)	-				27.6	10.2	8	0.46+0.46	16.9/16.1/15.5	18.0/17.1/16.5			
PURY-P400YNW-A(-BS)	-				35.1	10.9	8	0.46+0.46	19.5/18.5/17.9	23.0/21.8/21.0			
PURY-P450YNW-A(-BS)	-				37.1	12.4	8	0.46+0.46	20.8/19.8/19.1	22.7/21.6/20.8			
PURY-P500YNW-A(-BS)	-				43.2	13.0	8	0.92+0.92	21.4/20.3/19.6	25.7/24.5/23.6			
PURY-P550YNW-A(-BS)	-				47.5	14.3	8	0.92+0.92	27.0/25.7/24.7	30.2/28.7/27.6			
PURY-P400YSNW-A(-BS)	PURY-P200YNW-A(-BS)				50/60	380 400 415	Max:456V Min:342V	16.1	5.6	8	0.92	15.4/14.7/14.1	16.4/15.5/15.0
PURY-P400YSNW-A(-BS)	PURY-P200YNW-A(-BS)							16.1	5.6	8	0.92		
PURY-P450YSNW-A(-BS)	PURY-P250YNW-A(-BS)							17.8	7.0	8	0.92	17.8/16.9/16.3	18.5/17.6/16.9
PURY-P450YSNW-A(-BS)	PURY-P200YNW-A(-BS)							16.1	5.6	8	0.92		
PURY-P500YSNW-A(-BS)	PURY-P250YNW-A(-BS)							17.8	7.0	8	0.92	20.7/19.7/18.9	21.1/20.0/19.3
PURY-P500YSNW-A(-BS)	PURY-P250YNW-A(-BS)							17.8	7.0	8	0.92		
PURY-P550YSNW-A(-BS)	PURY-P300YNW-A(-BS)							22.7	7.9	8	0.92	24.3/23.1/22.3	24.8/23.5/22.7
PURY-P550YSNW-A(-BS)	PURY-P250YNW-A(-BS)							17.8	7.0	8	0.92		
PURY-P600YSNW-A(-BS)	PURY-P300YNW-A(-BS)							22.7	7.9	8	0.92	28.0/26.6/25.6	29.7/28.2/27.2
PURY-P600YSNW-A(-BS)	PURY-P300YNW-A(-BS)							22.7	7.9	8	0.92		
PURY-P650YSNW-A(-BS)	PURY-P350YNW-A(-BS)							27.6	10.2	8	0.46+0.46	30.7/29.1/28.1	32.6/31.0/29.9
PURY-P650YSNW-A(-BS)	PURY-P300YNW-A(-BS)							22.7	7.9	8	0.92		
PURY-P700YSNW-A(-BS)	PURY-P350YNW-A(-BS)							27.6	10.2	8	0.46+0.46	34.9/33.2/32.0	36.3/34.5/33.3
PURY-P700YSNW-A(-BS)	PURY-P350YNW-A(-BS)							27.6	10.2	8	0.46+0.46		
PURY-P750YSNW-A(-BS)	PURY-P400YNW-A(-BS)							35.1	10.9	8	0.46+0.46	37.6/35.7/34.4	41.9/39.8/38.4
PURY-P750YSNW-A(-BS)	PURY-P350YNW-A(-BS)							27.6	10.2	8	0.46+0.46		
PURY-P800YSNW-A(-BS)	PURY-P400YNW-A(-BS)							35.1	10.9	8	0.46+0.46	40.3/38.3/36.9	47.5/45.1/43.5
PURY-P800YSNW-A(-BS)	PURY-P400YNW-A(-BS)							35.1	10.9	8	0.46+0.46		
PURY-P850YSNW-A(-BS)	PURY-P450YNW-A(-BS)							37.1	12.4	8	0.46+0.46	42.1/40.0/38.6	48.0/45.6/44.0
PURY-P850YSNW-A(-BS)	PURY-P400YNW-A(-BS)							35.1	10.9	8	0.46+0.46		
PURY-P900YSNW-A(-BS)	PURY-P450YNW-A(-BS)	37.1	12.4	8				0.46+0.46	43.4/41.3/39.8	47.3/44.9/43.3			
PURY-P900YSNW-A(-BS)	PURY-P450YNW-A(-BS)	37.1	12.4	8				0.46+0.46					
PURY-P950YSNW-A(-BS)	PURY-P500YNW-A(-BS)	43.2	13.0	8				0.92+0.92	44.5/42.3/40.8	50.2/47.7/46.0			
PURY-P950YSNW-A(-BS)	PURY-P450YNW-A(-BS)	37.1	12.4	8				0.46+0.46					
PURY-P1000YSNW-A(-BS)	PURY-P500YNW-A(-BS)	43.2	13.0	8				0.92+0.92	44.6/42.4/40.8	53.5/50.9/49.0			
PURY-P1000YSNW-A(-BS)	PURY-P500YNW-A(-BS)	43.2	13.0	8				0.92+0.92					
PURY-P1050YSNW-A(-BS)	PURY-P550YNW-A(-BS)	47.5	14.3	8				0.92+0.92	49.2/46.8/45.1	57.5/54.6/52.7			
PURY-P1050YSNW-A(-BS)	PURY-P500YNW-A(-BS)	43.2	13.0	8				0.92+0.92					
PURY-P1100YSNW-A(-BS)	PURY-P550YNW-A(-BS)	47.5	14.3	8	0.92+0.92	54.9/52.1/50.2	63.3/60.1/57.9						
PURY-P1100YSNW-A(-BS)	PURY-P550YNW-A(-BS)	47.5	14.3	8	0.92+0.92								

PURY-P-Y(S)NW-A

10-3. Power cable specifications

Thickness of wire for main power supply, capacities of the switch and system impedance

	Model	Minimum wire thickness (mm ²)			Ground-fault interrupter *1	Local switch (A)		Breaker for wiring (A) (Non-fuse breaker)	Max. Permissible System Impedance
		Main cable	Branch	Ground		Capacity	Fuse		
Outdoor unit	PURY-P200YNW-A	4.0	-	4.0	30A 100mA 0.1sec. or less	25	25	30	*2
	PURY-P250YNW-A	4.0	-	4.0	30A 100mA 0.1sec. or less	32	32	30	*2
	PURY-P300YNW-A	4.0	-	4.0	30A 100mA 0.1sec. or less	32	32	30	*2
	PURY-P350YNW-A	6.0	-	6.0	40A 100mA 0.1sec. or less	40	40	40	0.26Ω
	PURY-P400YNW-A	10.0	-	10.0	60A 100mA 0.1sec. or less	63	63	60	0.20Ω
	PURY-P450YNW-A	10.0	-	10.0	60A 100mA 0.1sec. or less	63	63	60	0.19Ω
	PURY-P500YNW-A	10.0	-	10.0	60A 100mA 0.1sec. or less	63	63	60	0.16Ω
	PURY-P550YNW-A	10.0	-	10.0	60A 100mA 0.1sec. or less	63	63	60	0.15Ω
Total operating current of the indoor unit	F0 = 20A or less *3	1.5	1.5	1.5	Current sensitivity *4	16	16	20	(apply to IEC61000-3-3)
	F0 = 30A or less *3	2.5	2.5	2.5	Current sensitivity *4	25	25	30	(apply to IEC61000-3-3)
	F0 = 40A or less *3	4.0	4.0	4.0	Current sensitivity *4	32	32	40	(apply to IEC61000-3-3)

*1 The Ground-fault interrupter should support Inverter circuit. The Ground-fault interrupter should combine using of local switch or wiring breaker.

*2 Meet technical requirements of IEC61000-3-3

*3 Please take the larger of F1 or F2 as the value for F0.

F1 = Total operating maximum current of the indoor units × 1.2

F2 = {V1 × (Quantity of Type1)/C} + {V1 × (Quantity of Type2)/C} + {V1 × (Quantity of Type3)/C} + {V1 × (Quantity of Type4)/C} + {V1 × (Quantity of Type5)/C} + {V1 × (Quantity of Type6)/C} + {V1 × (Quantity of Type7)/C} + {V1 × (Quantity of Others)/C}

Indoor unit		V1	V2
Type1	PEFY-VMS, PFFY-VKM, PFFY-VLRMM	18.6	2.4
Type2	PEFY-VMA	38	1.6
Type3	PEFY-P200, 250VMHS	13.8	4.8
Type4	PEFY-P40-140VMHS	26.8	1.6
Type5	PLFY-VBM, PCFY-VKM	19.8	2.4
Type6	PMFY-VBM, PKFY-VKM, PKFY-VHM	9.9	2.4
Type7	PLFY-VEM, PLFY-VFM	17.1	2.4
Others	Other indoor unit	0	0

C: Multiple of tripping current at tripping time 0.01s
Please pick up "C" from the tripping characteristic of the breaker.

<Example of "F2" calculation>

*Condition PEFY-VMS × 4 + PEFY-VMA × 1, C = 8 (refer to right sample chart)

F2 = 18.6 × 4/8 + 38 × 1/8

= 14.05

→ 16 A breaker (Tripping current = 8 × 16 A at 0.01s)

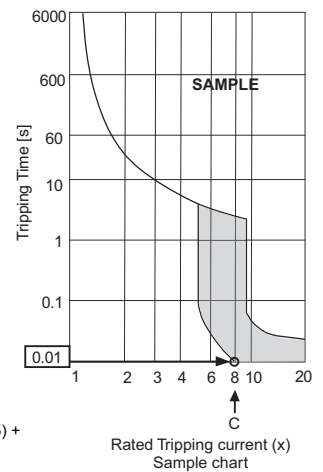

*4 Current sensitivity is calculated using the following formula.

G1 = (V2 × Quantity of Type1) + (V2 × Quantity of Type2) + (V2 × Quantity of Type3) + (V2 × Quantity of Type4) + (V2 × Quantity of Type5) + (V2 × Quantity of Type6) + (V2 × Quantity of Type7) + (V2 × Quantity of Others) + (V3 × Wire length [km])

G1	Current sensitivity	Wire thickness	V3
30 or less	30 mA 0.1sec or less	1.5 mm ²	48
100 or less	100 mA 0.1sec or less	2.5 mm ²	56
		4.0 mm ²	66

1. Use dedicated power supplies for the outdoor unit and indoor unit. Ensure OC and OS are wired individually.
2. Bear in mind ambient conditions (ambient temperature, direct sunlight, rain water, etc.) when proceeding with the wiring and connections.
3. The wire size is the minimum value for metal conduit wiring. If the voltage drops, use a wire that is one rank thicker in diameter. Make sure the power-supply voltage does not drop more than 10%. Make sure that the voltage imbalance between the phases is 2% or less.
4. Specific wiring requirements should adhere to the wiring regulations of the region.
5. Power supply cords of parts of appliances for outdoor use shall not be lighter than polychloroprene sheathed flexible cord (design 60245 IEC57). For example, use wiring such as YZW.
6. A switch with at least 3 mm contact separation in each pole shall be provided when the Air Conditioner is installed.

WARNING

- ◆ Be sure to use specified wires for connections and ensure no external force is imparted to terminal connections. If connections are not fixed firmly, heating or fire may result.
- ◆ Be sure to use the appropriate type of overcurrent protection switch. Note that generated overcurrent may include some amount of direct current.

CAUTION

- ◆ The breakers for current leakage should support Inverter circuit. (e.g. Mitsubishi Electric's NV-S-Series or equivalent). If no earth leakage breaker is installed, it may cause an electric shock.
- ◆ Breakers for current leakage should combine using of switch.
- ◆ Do not use anything other than a breaker with the correct capacity. Using a breaker of too large capacity may cause malfunction or fire.
- ◆ If a large electric current flows due to malfunction or faulty wiring, earth-leakage breakers on the unit side and on the upstream side of the power supply system may both operate. Depending on the importance of the system, separate the power supply system or take protective coordination of breakers.

Note

- ◆ This device is intended for the connection to a power supply system with a maximum permissible system impedance shown in the above table at the interface point (power service box) of the user's supply.
- ◆ The user must ensure that this device is connected only to a power supply system which fulfils the requirement above. If necessary, the user can ask the public power supply company for the system impedance at the interface point.
- ◆ This equipment complies with IEC 61000-3-12 provided that the short-circuit power Ssc is greater than or equal to Ssc (*2) at the interface point between the user's supply and the public system. It is the responsibility of the installer or user of the equipment to ensure, by consultation with the distribution network operator if necessary, that the equipment is connected only to a supply with a short-circuit power Ssc greater than or equal to Ssc (*2).

Ssc(*2)

Model	Ssc(MVA)
PURY-P200YNW-A	1.25
PURY-P250YNW-A	1.38
PURY-P300YNW-A	1.76
PURY-P350YNW-A	2.14
PURY-P400YNW-A	2.72
PURY-P450YNW-A	2.88
PURY-P500YNW-A	3.35
PURY-P550YNW-A	3.69

10-4. Power supply examples

The local standards and/or regulations is applicable at a higher priority.
 10-4-1. PURY-P200, 250, 300, 350, 400, 450, 500, 550YNW-A

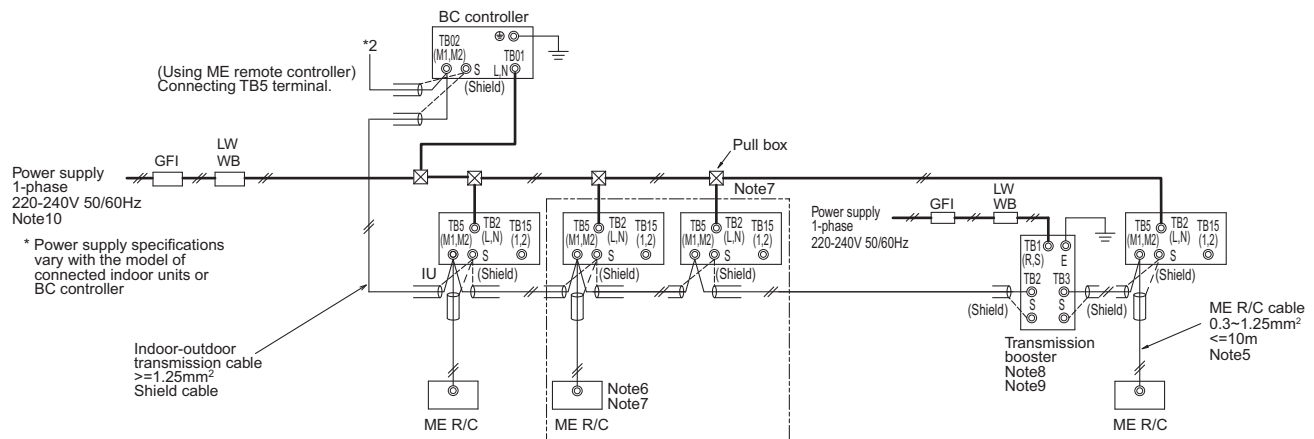
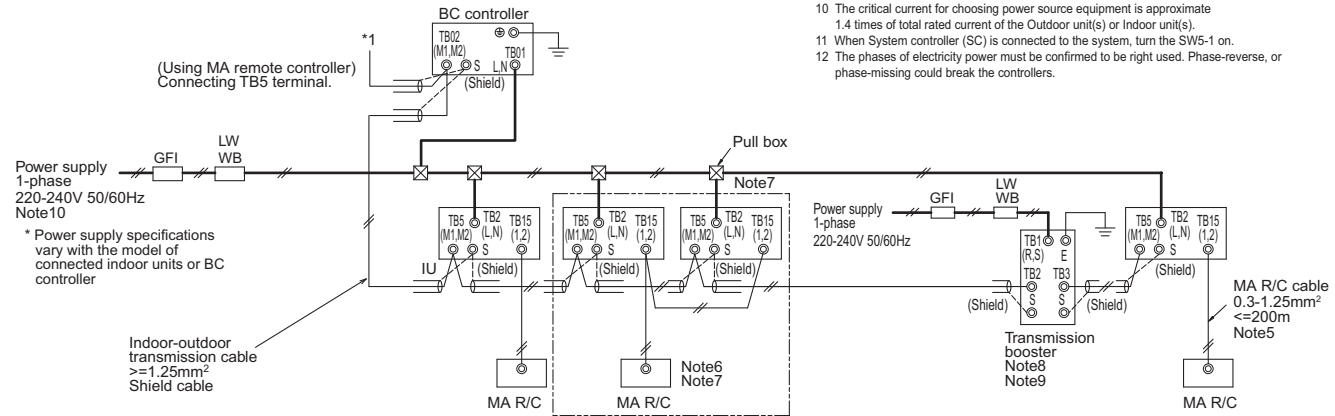
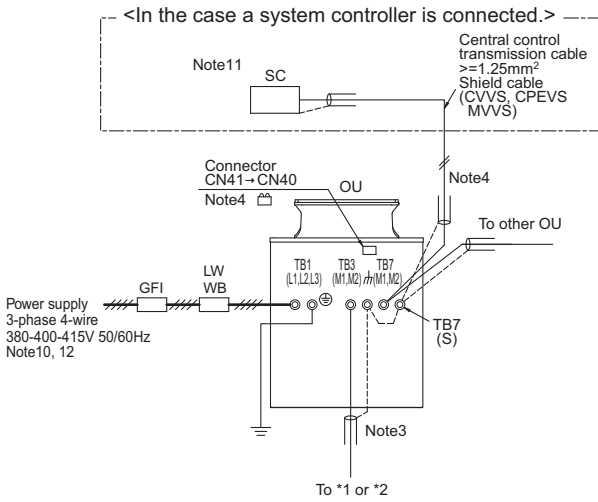

Symbol	Model	Ground-fault interrupter *1, *2, *4	Local switch		Wiring breaker *4 (NFB) <A>	Minimum Wire thickness				
			BKC <A>	OCP*3, *4 <A>		Power wire <mm²>	Earth wire <mm²>			
GFI	Ground-fault interrupter	PURY-P200YNW-A	30A	100mA	0.1sec. or less	25	25	30	4	4
LW	Local switch	PURY-P250YNW-A	30A	100mA	0.1sec. or less	32	32	30	4	4
BKC	Breaker capacity	PURY-P300YNW-A	30A	100mA	0.1sec. or less	32	32	30	4	4
OCP	Over-current protector	PURY-P350YNW-A	40A	100mA	0.1sec. or less	40	40	40	6	6
WB	Wiring breaker	PURY-P400YNW-A	60A	100mA	0.1sec. or less	63	63	60	10	10
NFB	Non-fuse breaker	PURY-P450YNW-A	60A	100mA	0.1sec. or less	63	63	60	10	10
OU	Outdoor unit	PURY-P500YNW-A	60A	100mA	0.1sec. or less	63	63	60	10	10
IU	Indoor unit	PURY-P550YNW-A	60A	100mA	0.1sec. or less	63	63	60	10	10
SC	System controller									
MA R/C	MA remote controller									
ME R/C	ME remote controller									

*1 The Ground-fault interrupter should support Inverter circuit. (e.g. Mitsubishi Electric's NV-S-Series or equivalent).
 *2 Ground-fault interrupter should combine using of local switch or wiring breaker.
 *3 It shows data for B-type fuse of the breaker for current leakage.
 *4 If a large electric current flows due to malfunction or faulty wiring, earth-leakage breakers on the unit side and on the centralized controller side may both operate.
 Depending on the importance of the system, separate the power supply system or take protective coordination of breakers.

- Note:
- The transmission cable is not-polarity double-wire.
 - Symbol Ⓞ means a screw terminal for wiring.
 - The shield wire of transmission cable should be connected to the grounding terminal at Outdoor unit. All shield wire of M-NET transmission cable among Indoor units should be connected to the S terminal at Indoor unit or all shield wire should be connected together. The broken line at the scheme means shield wire.
 - When the Outdoor unit connected with system controller, power-supply to TB7 of the outdoor unit(s) is needed. The connector change from CN41 to CN40 at one of the outdoor units will enable the outdoor unit to supply power to TB7, or an extra power supplying unit PAC-SC51KUA should be used. The transmission cable (above 1.25mm², shielded, CVVS/CPEVS/MVVS) among Outdoor units and system controllers is called central control transmission cable. The shield wire of the central control transmission cable must be grounded at the Outdoor unit whose CN41 is changed to CN40. When the power supplying unit PAC-SC51KUA is used, connect the shielded cable to the ground terminal on the PAC-SC51KUA.
 - MA R/C transmission cable (0.3-1.25mm²) must be less than 200m in length, while ME R/C transmission cable (0.3-1.25mm²) must be less than 10m in length. But transmission cable to the ME R/C can be extend using a M-NET cable (>=1.25mm²) when the length is counted in the M-Net length.
 - MA remote controller and ME remote controller should not be grouped together. When a PAR-CT01MA or PAR-3X MA-Series (X indicates 1, 2, ...) is connected to a group, no other MA remote controllers can be connected to the same group.
 - If using 1 or 2 (main/sub) MA remote controller to control more than 1 Indoor unit, use MA transmission cable to connect all the TB15 terminals of the Indoor units. It is called "Grouping".
 If using 1 or 2 (main/sub) ME remote controller control more than 1 indoor unit, set address to Indoor unit and ME remote controller. For the method, refer to 11-4. *Address setting*.
 - Indoor board consumes power from TB3. The power balance should be considered according to System Design 11-3. *System configuration restrictions*.
 - If Transmission booster is needed, be sure to connect the shield wires to the both sides to the booster.
 - The critical current for choosing power source equipment is approximate 1.4 times of total rated current of the Outdoor unit(s) or Indoor unit(s).
 - When System controller (SC) is connected to the system, turn the SW5-1 on.
 - The phases of electricity power must be confirmed to be right used. Phase-reverse, or phase-missing could break the controllers.

PURY-P-Y(S)NW-A

The local standards and/or regulations is applicable at a higher priority.

10-4-2. PURY-P400, 450, 500, 550, 600, 650, 700, 750, 800, 850, 900, 950, 1000, 1050, 1100YSNW-A

<In the case a system controller is connected.>

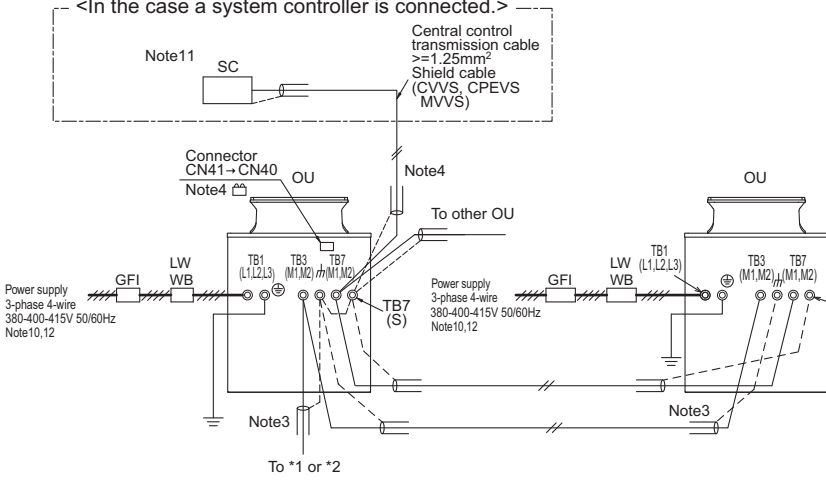

- Note:
- The transmission cable is not-polarity double-wire.
 - Symbol Ⓞ means a screw terminal for wiring.
 - The shield wire of transmission cable should be connected to the grounding terminal at Outdoor unit. All shield wire of M-Net transmission cable among Indoor units should be connected to the S terminal at Indoor unit or all shield wire should be connected together. The broken line at the scheme means shield wire.
 - When the Outdoor unit connected with system controller, power-supply to TB7 of the outdoor unit(s) is needed. The connector change from CN41 to CN40 at one of the outdoor units will enable the outdoor unit to supply power to TB7, or an extra power supplying unit PAC-SC51KUA should be used. The transmission cable (above 1.25mm², shielded, CVVS/CPEVS/MVVS) among Outdoor units and system controllers is called central control transmission cable. The shield wire of the central control transmission cable must be grounded at the Outdoor unit whose CN41 is changed to CN40. When the power supplying unit PAC-SC51KUA is used, connect the shielded cable to the ground terminal on the PAC-SC51KUA.
 - MA R/C transmission cable (0.3-1.25mm²) must be less than 200m in length, while ME R/C transmission cable (0.3-1.25mm²) must be less than 10m in length. But transmission cable to the ME R/C can be extended using a M-NET cable (>=1.25mm²) when the length is counted in the M-Net length.
 - MA remote controller and ME remote controller should not be grouped together. When a PAR-CT01MA or PAR-3X MA-Series (X indicates 1, 2, ...) is connected to a group, no other MA remote controllers can be connected to the same group.
 - If using 1 or 2 (main/sub) MA remote controller to control more than 1 Indoor unit, use MA transmission cable to connect all the TB15 terminals of the Indoor units. It is called "Grouping".
 - If using 1 or 2 (main/sub) ME remote controller control more than 1 indoor unit, set address to Indoor unit and ME remote controller. For the method, refer to 11-4. "Address setting".
 - Indoor board consumes power from TB3. The power balance should be considered according to System Design 11-3. "System configuration restrictions".
 - If Transmission booster is needed, be sure to connect the shield wires to the both sides to the booster.
 - The critical current for choosing power source equipment is approximate 1.4 times of total rated current of the Outdoor unit(s) or Indoor unit(s).
 - When System controller (SC) is connected to the system, turn the SW5-1 on.
 - The phases of electricity power must be confirmed to be right used. Phase-reverse, or phase-missing could break the controllers.

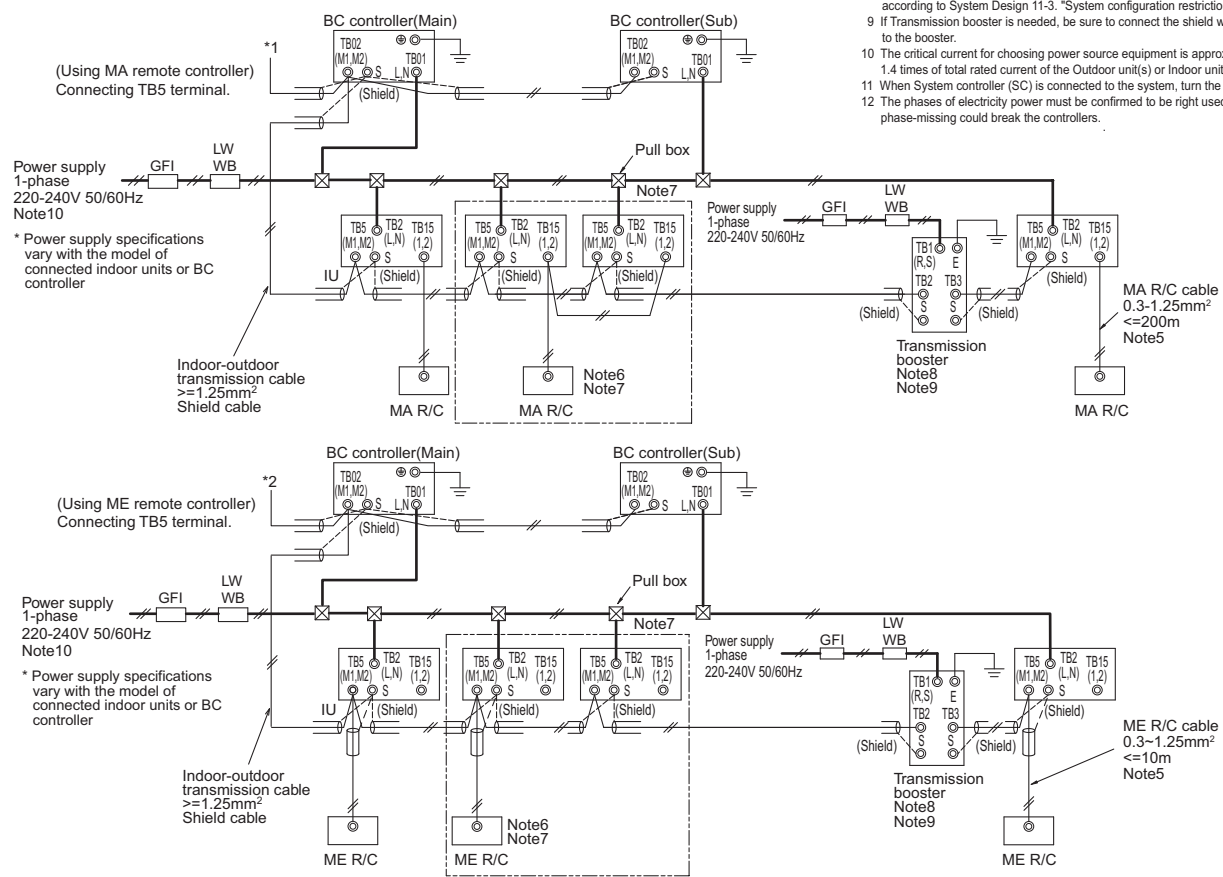

Symbol	Model	Ground-fault interrupter *1, *2, *4	Local switch		Wiring breaker *4 (NFB) <A>	Minimum Wire thickness		
			BKC <A>	OCP*3, *4 <A>		Power wire <mm²>	Earth wire <mm²>	
GFI	Ground-fault interrupter	PURY-P200YNW-A	30A 100mA 0.1sec. or less	25	25	30	4	4
LW	Local switch	PURY-P250YNW-A	30A 100mA 0.1sec. or less	32	32	30	4	4
BK	Breaker capacity	PURY-P300YNW-A	30A 100mA 0.1sec. or less	32	32	30	4	4
OCP	Over-current protector	PURY-P350YNW-A	40A 100mA 0.1sec. or less	40	40	40	6	6
WB	Wiring breaker	PURY-P400YNW-A	60A 100mA 0.1sec. or less	63	63	60	10	10
NFB	Non-fuse breaker	PURY-P450YNW-A	60A 100mA 0.1sec. or less	63	63	60	10	10
OU	Outdoor unit	PURY-P500YNW-A	60A 100mA 0.1sec. or less	63	63	60	10	10
IU	Indoor unit	PURY-P550YNW-A	60A 100mA 0.1sec. or less	63	63	60	10	10

*1 The Ground-fault interrupter should support Inverter circuit. (e.g. Mitsubishi Electric's NV-S-Series or equivalent).
 *2 Ground-fault interrupter should combine using of local switch or wiring breaker.
 *3 It shows data for B-type fuse of the breaker for current leakage.
 *4 If a large electric current flows due to malfunction or faulty wiring, earth-leakage breakers on the unit side and on the centralized controller side may both operate.
 Depending on the importance of the system, separate the power supply system or take protective coordination of breakers.

PURY-P-Y(S)NW-A

11-1. Transmission cable length limitation

11-1-1. Using MA Remote controller

Long transmission cable causes voltage down, therefore, the length limitation should be obeyed to secure proper transmission.

Max. length via Outdoor (M-NET cable)	$L1+L2+L3, L1+L2+L4+L5, L3+L4+L5, L6+L2+L3, L6+L2+L4+L5$	$\leq 500m(1000m^*1)[1640ft.(3280ft.^*1)]$	1.25mm ² [AWG16] or thicker
Max. length to Outdoor (M-NET cable)	$L1+L6, L3, L2+L4+L6, L5$	$\leq 200m[656ft.]$	1.25mm ² [AWG16] or thicker
Max. length from MA to Indoor for each group	$a1+a2, a1+a2+a3+a4$	$\leq 200m[656ft.]$	0.3-1.25 mm ² [AWG22-16]
24VDC to AG-150A	n	$\leq 50m[164ft.]$	0.75-2.0 mm ² [AWG18-14]

*1 When the wiring length exceeds 500 m (1640 ft), consult the sales office.

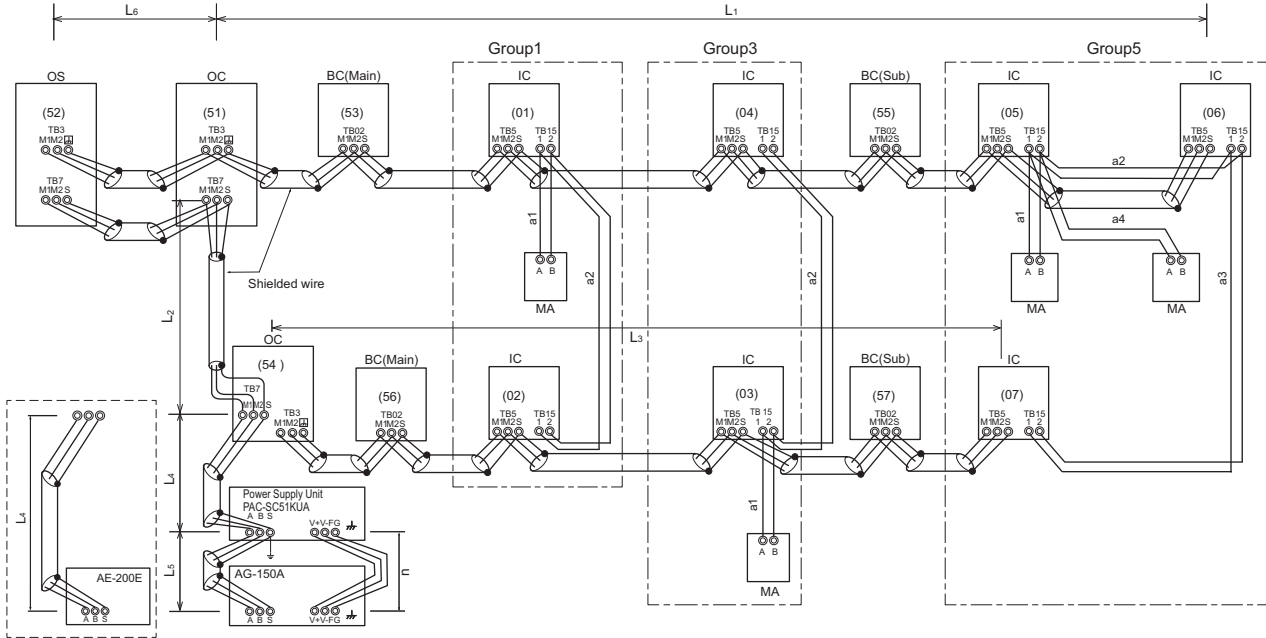

OC, OS: Outdoor unit controller; IC: Indoor unit controller; MA: MA remote controller

11-1-2. Using ME Remote controller

Long transmission cable causes voltage down, therefore, the length limitation should be obeyed to secure proper transmission.

Max. length via Outdoor (M-NET cable)	$L1+L2+L3+L4, L1+L2+L6+L7, L1+L2+L3+L5, L3+L4+L6+L7, L8+L2+L3+L4, L8+L2+L3+L5, L8+L2+L6+L7, L3+L5+L6+L7$	$\leq 500m(1000m^*1)[1640ft.(3280ft.^*1)]$	1.25mm ² [AWG16] or thicker
Max. length to Outdoor (M-NET cable)	$L1+L8, L3+L4, L2+L6+L8, L7, L3+L5$	$\leq 200m[656ft.]$	1.25mm ² [AWG16] or thicker
Max. length from ME to Indoor	$e1, e2, e3, e4$	$\leq 10m[32ft.]^*2$	0.3-1.25 mm ² [AWG22-16] *2
24VDC to AG-150A	n	$\leq 50m[164ft.]$	0.75-2.0 mm ² [AWG18-14]

*1 When the wiring length exceeds 500 m (1640 ft), consult the sales office.

*2. If the length from ME to Indoor exceed 10m, use 1.25 mm² [AWG16] shielded cable, but the total length should be counted into Max. length via Outdoor.

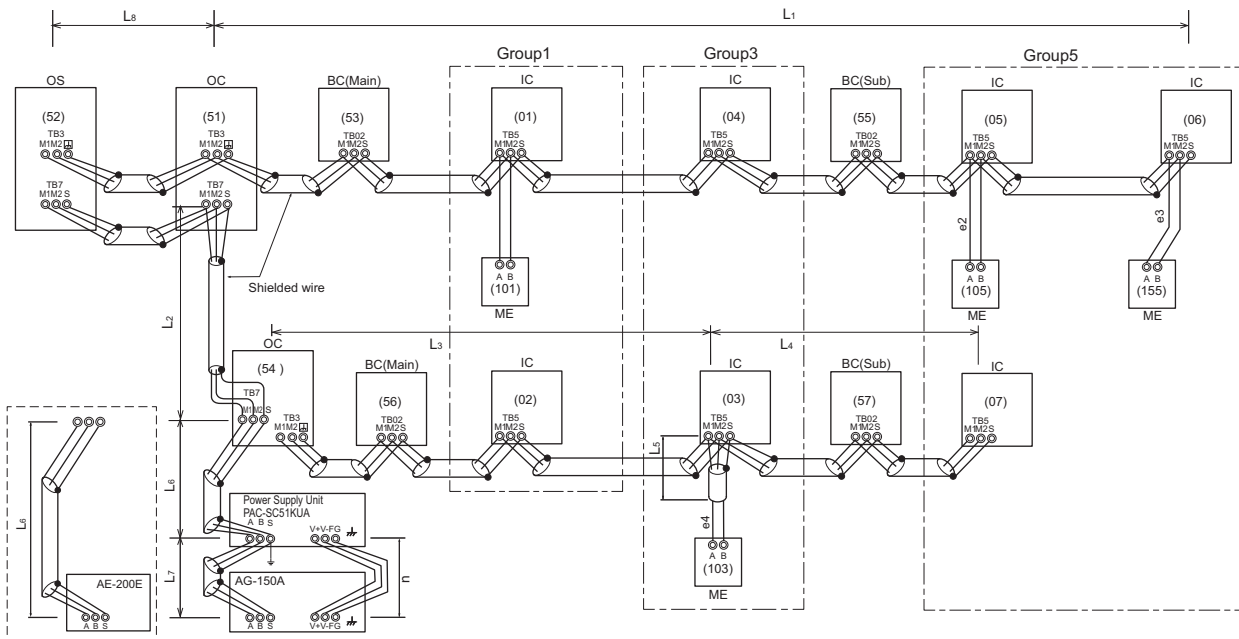

OC, OS: Outdoor unit controller; IC: Indoor unit controller; ME: ME remote controller

PURY-P-Y(S)NW-A

11-2. Transmission cable specifications

	Transmission cables (Li)	M-NET remote controller cables (ei)	MA Remote controller cables (ai)
Type of cable	Shielding wire (2-core) CVVS, CPEVS or MVVS	Sheathed 2-core cable (unshielded) CVV	
Cable size	More than 1.25 mm ² [AWG16]	0.3~1.25 mm ² [AWG22~16]	0.3~1.25 mm ² [AWG22 ~16]*1
Remarks	Max length: within 200 m	When 10 m [32ft] is exceeded, use cables with the same specification as transmission cables.	Max length: 200 m [656ft]

*1 To wire PAR-CT01MA, PAR-3X MA-Series (X indicates 1, 2...), and Simple MA remote controller, use a wire with a diameter of 0.3 mm² [AWG22]

CVVS, MVVS: PVC insulated PVC sheathed shielded control cable
 CPEVS: PE insulated PVC sheathed shielded communication cable
 CVV: PVC insulated PVC sheathed control cable

11-3. System configuration restrictions

11-3-1. Common restrictions for the CITY MULTI system

For each Outdoor/Heat source unit, the maximum connectable quantity of Indoor unit is specified at its Specifications table.

- A) 1 Group of Indoor units can have 1-16 Indoor units;
*OA processing unit GUF-RD(H) is considered as Indoor unit.
- B) Maximum 2 remote controllers for 1 group;
*MA/ME remote controllers cannot be present together in 1group.
*When a PAR-CT01MA, PAR-40MA, or PAR-3X MA-Series (X indicates 1, 2...) is connected to a group, no other MA remote controllers can be connected to the same group.
- C) 1 Lossnay unit can interlock maximum 16 Indoor units; 1 Indoor unit can interlock only 1 Lossnay unit.
- D) Maximum 3 System controllers are connectable when connecting to TB3 of the Outdoor/Heat source unit.
- E) A maximum of 6 system controller are connectable to TB3 and TB7 of Outdoor/Heat source unit.
- F) 4 System controllers or more are connectable when connecting to TB7 of the Outdoor/Heat source unit, if the transmission power is supplied by the power supply unit PAC-SC51KUA.
*System controller connected as described in D) would have a risk that the failure of connected Outdoor/Heat source unit would stop power supply to the System controller.

11-3-2. Ensuring proper communication power and the number of connected units for M-NET

In order to ensure proper communication among Outdoor/Heat source unit, Indoor unit, Lossnay, OA processing unit GUF-RD(H), and Controllers, the transmission power situation for the M-NET should be observed. In some cases, Transmission booster should be used. Taking the power consumption of Indoor unit as 1, the equivalent power consumption or supply of others are listed at Table 1 and Table 2.

Both the transmission line for centralized controller and indoor-outdoor transmission line must meet the conditions listed below. (Both conditions a) and b) must be met.)

- a) [Total equivalent power consumption] ≤ [The equivalent power supply]
- b) [Total equivalent number of units (Table 1)] ≤ [40]

Table 1 The equivalent power consumption and the equivalent number of units

Category	Model	The equivalent power consumption	The equivalent number of units
CITY MULTI indoor unit OA unit CITY MULTI connection kit Air handling unit controller	Except for the models indicated by *2 PEFY-AF2500, 3000, 4000, 5000, 6000MH GUF-50, 100 PAC-LV11M-J PAC-AH125, 140, 250, 500M-J	1	1
CITY MULTI indoor unit *2	PDFY-P100VM-E-RE	2	2
BC controller	CMB	2	1
PWFY *1	P100VM-E-BU	6	1
	P200VM-E1-AU P200VM-E2-AU	5	1
	(E)P100VM-E1-AU (E)P100VM-E2-AU P140VM-E1-AU P140VM-E2-AU	1	1
PFAV	P250, 300, 500, 600VM-E(-F)	1	1
	P750, 900VM-E(-F)	2	2
PFV, PEV	P200, 250, 400, 500YM-A	1	1
MA remote controller/Lossnay	PAR-CT01MA PAR-21MA PAR-31MA PAR-32MA PAR-33MA PAR-40MA PAC-YT52CRA PAR-FA32MA LGH PZ-60DR-E PZ-61DR-E PZ-43SMF-E	0	0
ME remote controller	PAR-U02MEDA	0.5	1
	PZ-52SF	0.25	1
System controller	AE-200E AE-50E EW-50E LM-AP	0	0
	AG-150A EB-50GU-J PAC-IF01AHC-J	0.5	1
	AT-50B	1.5	5
	PAC-YG60MCA PAC-YG66DCA PAC-YG63MCA	0.25	1
ON/OFF controller	PAC-YT40ANRA	1	1
MN converter	CMS-MNG-E	2	1
Outdoor/Heat source unit	TB7 power consumption	0	0
System control interface	MAC-333IF-E	0	0
A-M converter	PAC-SF83MA-E		

*1 PWFY cannot be connected to PUMY model.

Table 2 The equivalent power supply

Category	Model	The equivalent power supply		
Transmission Booster	PAC-SF46EPA	25 *1		
Power supply unit	PAC-SC51KUA	5		
Expansion controller	PAC-YG50ECA	6		
BM ADAPTER	BAC-HD150	6		
System controller	AE-200E/AE-50E	0.75		
	EW-50E	1.5		
	LM-AP	0		
Outdoor/Heat source unit		TB3 and TB7 total	TB7 only	TB3 only
	Outdoor unit except S-Series and TKA *2	32 *1	6	32 *1-equivalent power supplied to TB7
	S-Series outdoor unit	12 *1	0	12 *1
	TKA outdoor unit	32 *1	- *3	32 *1

*1 When one or more indoor units listed below is connected, subtract 3 from the equivalent power supply.

Table 3

Category	Model
Indoor unit	Sized P200/P250
	PEFY-AF4000/5000/6000MH, PFFY-P400/500YM-E, PDFY-P100VM-E-RE
Air handling unit controller	PAC-AH250/500M-J
PFAV	PFAV-P500/600/750/900VM-E(-F)
PFV	PFV-P400/500YM-A
PEV	PEV-P400/500YM-A

*2 If PAC-SC51KUA is used to supply power at TB7 side, no power supply need from Outdoor/Heat source unit at TB7, Connector TB3 itself will therefore have 32.

*3 Do not supply power to TB7 from TKA outdoor units.
Use PAC-SC51KUA or PAC-SF46EPA when connecting an M-NET device to TB7.

With the equivalent power consumption values and the equivalent number of units in Table 1 and Table 2, PAC-SF46EPA can be designed into the air-conditioner system to ensure proper system communication according to (A), (B), (C).

- (A) Firstly, count from TB3 at TB3 side the total equivalent number of units of Indoor units, OA processing units, ME remote controller, and System controllers. If the total equivalent number of units reaches 40, a PAC-SF46EPA should be set.
- (B) Secondly, count from TB7 side to TB3 side the total transmission power consumption. If the total equivalent power supply reaches 32, a PAC-SF46EPA should be set. Yet, if a PAC-SC51KUA or another controller with a built-in power supply, such as PAC-YG50ECA, is used to supply power at TB7 side, count from TB3 side only.
- (C) Thirdly, count from TB7 at TB7 side the total transmission power consumption, If the total equivalent power supply for only TB7 reaches 6, a PAC-SF46EPA should be set. Also, count from TB7 at TB7 side the total equivalent number of units of System controllers, and so on. If the total equivalent number of units reaches 40, a PAC-SF46EPA should be set.

* The equivalent power supply of S-Series outdoor unit is 12.

* When one or more indoor units listed in Table 3 is connected, subtract 3 from the equivalent power supply.

■ System example

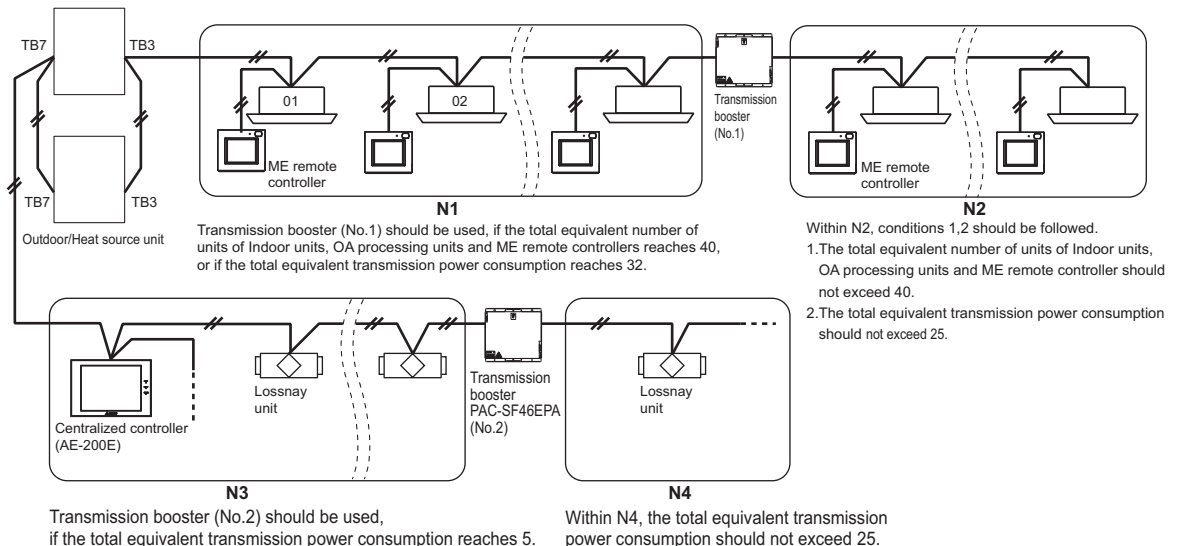

11-3-3. Ensuring proper power supply to System controller

The power to System controller (excluding AE-200E, AE-50E, EW-50E, BAC-HD150, LM-AP) is supplied via M-NET transmission line. M-NET transmission line at TB7 side is called Centralized control transmission line while one at TB3 side is called Indoor-Outdoor/Heat source transmission line. There are 3 ways to supply power to the System controller .

- A) Connecting to TB3 of the Outdoor/Heat source unit and receiving power from the Outdoor/Heat source unit.
- B) Connecting to TB7 of the Outdoor/Heat source unit and receiving power from the Outdoor/Heat source unit. (Not applicable to the PUMY model)
- C) Connecting to TB7 of the Outdoor/Heat source unit but receiving power from power supply unit PAC-SC51KUA.
 - * System controllers (AE-200E, AE-50E, EW-50E, BAC-HD150, LM-AP) have a built-in function to supply power to the M-NET transmission lines, so no power needs to be supplied to the M-NET transmission lines from the Outdoor/Heat source units or from PAC-SC51KUA.

11-3-3-A. When connecting to TB3 of the Outdoor/Heat source unit and receiving power from the Outdoor/Heat source unit.

Maximum 3 System controllers can be connected to TB3. If there is more than 1 Outdoor/Heat source unit, it is necessary to replace power supply switch connector CN41 with CN40 on one Outdoor/Heat source unit.

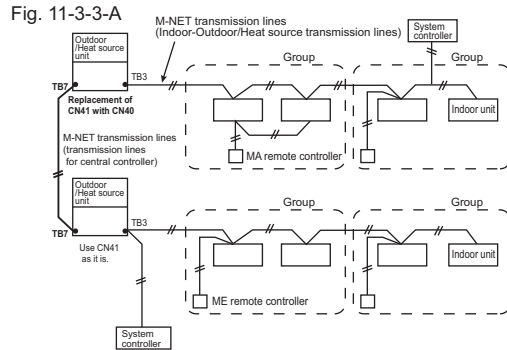

11-3-3-B. When connecting to TB7 of the Outdoor/Heat source unit and receiving power from the Outdoor/Heat source unit. (Not applicable to the PUMY model)

A maximum of 6 system controller are connectable to TB3 and TB7 of Outdoor/Heat source unit. (Not applicable to the PUMY model) It is necessary to replace power supply switch connector CN41 with CN40 on one Outdoor/Heat source unit.

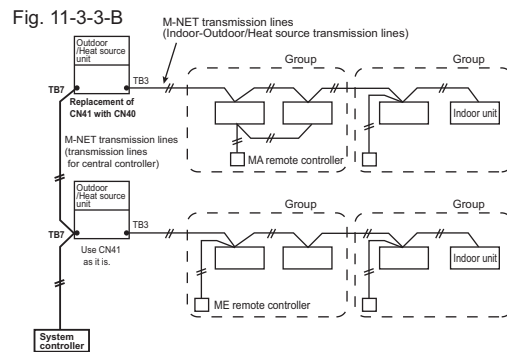

11-3-3-C. When connecting to TB7 of the Outdoor/Heat source unit but receiving power from PAC-SC51KUA.

When using PAC-SC51KUA to supply transmission power, the power supply connector CN41 on the Outdoor/Heat source units should be kept as it is. It is also a factory setting. 1 PAC-SC51KUA supports maximum 1 AG-150A or 1 EB-50GU-J unit due to the limited power 24VDC at its TB3. However, 1 PAC-SC51KUA supplies transmission power at its TB2 equal to 5 Indoor units, which is referable at Table 2. If System controller, ON/OFF controller connected to TB7 consume transmission power more than 5 (Indoor units), Transmission booster PAC-SF46EPA is needed. PAC-SF46EPA supplies transmission power equal to 25 Indoor units.

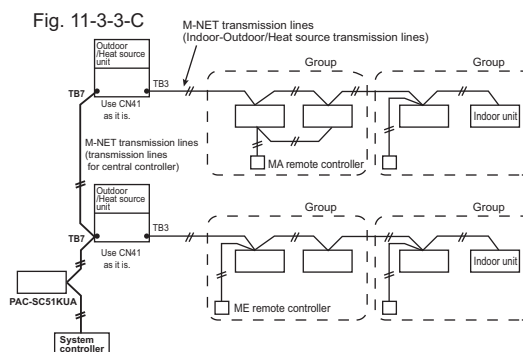

CAUTION

- AG-150A/EB-50GU-J*1 are recommended to connect to TB7 because it performs back-up to a number of data.
- In an air conditioner system has more than 1 Outdoor/Heat source units, AG-150A/EB-50GU-J receiving transmission power at TB3 or TB7 on one of the Outdoor/Heat source units would have a risk that the connected Outdoor/Heat source unit failure would stop power supply to AG-150A/EB-50GU-J, and disrupt the whole system.
- When applying apportioned electric power function, AG-150A/EB-50GU-J are necessary to connected to TB7 and has its own power supply unit PAC-SC51KUA.
- Note: Power supply unit PAC-SC51KUA is for AG-150A/EB-50GU-J.
- *1: AG-150A is an example model of system controllers.

Fig. 11-3-3-D

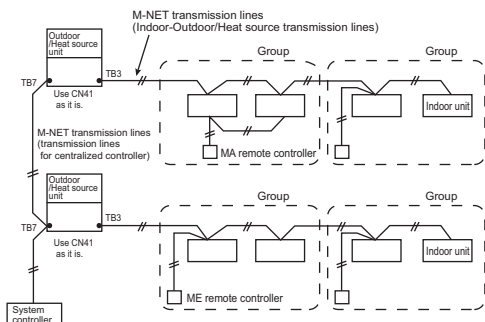

- How to connect system controllers (AE-200E, AE-50E, EW-50E, BAC-HD150, LM-AP) to a given system
- System controllers (AE-200E, AE-50E, EW-50E, BAC-HD150, LM-AP) have a built-in function to supply power to the M-NET transmission lines, so no power needs to be supplied to the M-NET transmission lines from the Outdoor/Heat source units or from PAC-SC51KUA.
- Leave the power supply connector on the Outdoor/Heat source unit connected to CN41 as it is.
- Refer to 11-3-2 for information about the power-supply capacity of each system controller (EW-50E, BAC-HD150, LM-AP) to the low-level system controllers.

PURY-P-Y(S)NW-A

11-3-4. Power supply to LM-AP

1-phase 220-240VAC power supply is needed.

The power supply unit PAC-SC51KUA is not necessary when connecting only the LM-AP. Yet, make sure to change the power supply changeover connector CN41 to CN40 on the LM-AP.

11-3-5. Power supply to expansion controller

1-phase 100-240VAC power supply is needed.

The power supply unit PAC-SC51KUA is not necessary.

The expansion controller supplies power through TB3, which equals 6 indoor units. (refer to Table 2)

11-3-6. Power supply to BM ADAPTER

1-phase 100-240VAC power supply is needed.

The power supply unit PAC-SC51KUA is not necessary when only BM ADAPTER is connected.

Yet, make sure to move the power jumper from CN41 to CN40 on the BM ADAPTER.

11-3-7. Power supply to AE-200E/AE-50E/EW-50E

1-phase 100-240VAC power supply is needed.

The power supply unit PAC-SC51KUA is not necessary when connecting only the AE-200E/AE-50E/EW-50E.

11-4. Address setting

11-4-1. Switch operation

In order to constitute CITY MULTI in a complete system, switch operation for setting the unit address No. and connection No. is required.

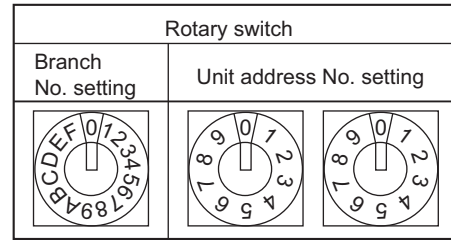

- ① Address No. of outdoor unit, indoor unit and remote controller.
The address No. is set at the address setting board.
In the case of R2 system, it is necessary to set the same No. at the branch No. switch of indoor unit as that of the BC controller connected. (When connecting two or more branches, use the lowest branch No.)

② Caution for switch operations

- Be sure to shut off power source before switch setting. If operated with power source on, switch can not operate properly.
- No units with identical unit address shall exist in one whole air conditioner system. If set erroneously, the system can not operate.

③ MA remote controller

- When connecting only one remote controller to one group, it is always the main remote controller.
When connecting two remote controllers to one group, set one remote controller as the main remote controller and the other as the sub remote controller.
- The factory setting is "Main".

PAR-3X MA-Series (X indicates 1, 2...), PAR-CT01MA
The MA remote controller does not have the switches listed above.
Refer to the installation manual for the function setting.





































PAC-YT52CRA

Setting the dip switches

There are switches on the back of the top case. Remote controller Main/Sub and other function settings are performed using these switches. Ordinarily, only change the Main/Sub setting of SW1.
(The factory settings are ON for SW1, 2, and 3 and OFF for SW4.)

SW No.	SW contents Main	ON	OFF	Comment
1	Remote controller Main/Sub setting	Main	Sub	Set one of the two remote controllers at one group to "ON".
2	Temperature display units setting	Celsius	Fahrenheit	When the temperature is displayed in [Fahrenheit], set to "OFF".
3	Cooling/heating display in AUTO mode	Yes	No	When you do not want to display "Cooling" and "Heating" in the AUTO mode, set to "OFF".
4	Indoor temperature display	Yes	No	When you want to display the indoor temperature, set to "ON".

11-4-2. Rule of setting address

Unit	Address setting	Example	Note	
Indoor unit System control interface (MAC-333IF-E) A-M converter (PAC-SF83MA-E) Air handling unit controller (PAC-AH125, 140, 250, 500M-J) CITY MULTI connection Kit (PAC-LV11M-J)	01 ~ 50	 	Use the most recent address within the same group of indoor units. Make the indoor units address connected to the BC controller (Sub) larger than the indoor units address connected to the BC controller (Main). If applicable, set the sub BC controllers in an PURY system in the following order: (1) Indoor unit to be connected to the BC controller (Main) (2) Indoor unit to be connected to the BC controller (No.1 Sub) (3) Indoor unit to be connected to the BC controller (No.2 Sub) Set the address so that (1)<(2)<(3) A maximum of 12 BC controllers are connectable.	
Outdoor unit	51 ~ 99, 100 (Note1)	 	The smallest address of indoor unit in same refrigerant system + 50 Assign sequential address numbers to the outdoor units in one refrigerant circuit system. OC, OS1 and OS2 are automatically detected. (Note 2) * Please reset one of them to an address between 51 and 99 when two addresses overlap. * The address automatically becomes "100" if it is set as "01~ 50"	
BC controller (Main)	52 ~ 99, 100	 	The address of outdoor unit + 1 * Please reset one of them to an address between 51 and 99 when two addresses overlap. * The address automatically becomes "100" if it is set as "01~ 50"	
BC controller (Sub)	52 ~ 99, 100	 	Lowest address within the indoor units connected to the BC controller (Sub) plus 50.	
Local remote controller	ME Remote controller (Main)	101 ~ 150 Fixed	 	The smallest address of indoor unit in the group + 100 * The place of "100" is fixed to "1"
	ME Remote controller (Sub)	151 ~ 199, 200 Fixed	 	The address of main remote controller + 50 * The address automatically becomes "200" if it is set as "00"
System controller	ON/OFF remote controller	201 ~ 250	  	The smallest group No. to be managed + 200 * The smallest group No. to be managed is changeable.
	AE-200E/AE-50E AG-150A EB-50GU-J EW-50E AT-50B	000, 201 ~ 250	  	* AT-50B cannot be set to "000".
	PAC-YG50ECA	000, 201 ~ 250	  	* Settings are made on the initial screen of AG-150A.
	BAC-HD150	000, 201 ~ 250	  	* Settings are made with setting tool of BM ADAPTER.
	LMAP04-E	201 ~ 250 Fixed	 	
PI, AI, DIDO	PAC-YG60MCA	01 ~ 50	 	
	PAC-YG63MCA	01 ~ 50	 	
	PAC-YG66DCA	01 ~ 50	 	
Lossnay, OA processing unit	01 ~ 50	 	After setting the addresses of all the indoor units, assign an arbitrary address.	
PAC-IF01AHC	201 ~ 250 Fixed	 		

Note1: To set the address to "100", set it to "50"

Note2: Outdoor units OC, OS1 and OS2 in one refrigerant circuit system are automatically detected. OC, OS1 and OS2 are ranked in descending order of capacity. If units are the same capacity, they are ranked in ascending order of their address.

11-4-3. System examples

Factory setting

Original switch setting of the outdoors, indoors, controllers, LM-AP and BM ADAPTER at shipment is as follows.

- Outdoor unit : Address: 00, CN41: ON (Jumper), DipSW5-1: OFF
- Indoor unit : Address: 00
- BC controller : Address: 00
- ME remote controller : Address: 101
- LM-AP : Address: 247, CN41: ON (Jumper), DipSW1-2: OFF
- BM ADAPTER : Address: 000, CN41: ON (Jumper)
- AE-200E/AE-50E/EW-50E : Address: 000, CN21: ON (Jumper)

Setting at the site

- DipSW5-1(Outdoor) : When the System Controller is used, all the Dip SW5-1 at the outdoor units should be set to "ON". * Dip SW5-1 remains OFF when only LM-AP is used.
- DipSW 4-1 and 4-6 (BC controller) : Set DipSW 4-6 to ON at BC controller, in case of connected Indoor unit sized P100-P250 with 2 ports. It is also possible to connect Indoor unit sized P100-P140 with 1 port (set DipSW 4-1 and 4-6 to OFF).
- DipSW1-2(LM-AP) : When the LM-AP is used together with System Controller, DipSW1-2 at the LM-AP should be set to "ON".
- CN40/CN41 : Change jumper from CN41 to CN 40 at outdoor control board will activate central transmission power supply to TB7;
(Change jumper at only one outdoor unit when activating the transmission power supply without using a power supply unit.)
Change jumper from CN41 to CN 40 at LM-AP/BM ADAPTER will activate transmission power supply to LM-AP/BM ADAPTER itself;
Power supply unit is recommended to use for a system having more than 1 outdoor unit, because the central transmission power supply from TB7 of one of outdoor units is risking that the outdoor unit failure may let down the whole system controller system.
- CN21(AE-200E/AE-50E/EW-50E) : Activates the power supply to M-NET transmission line from AE-200E/AE-50E/EW-50E (CN21: ON (power supplied), OFF (power not supplied))

11-4-3-1. MA remote controller, Single-refrigerant-system, No System Controller

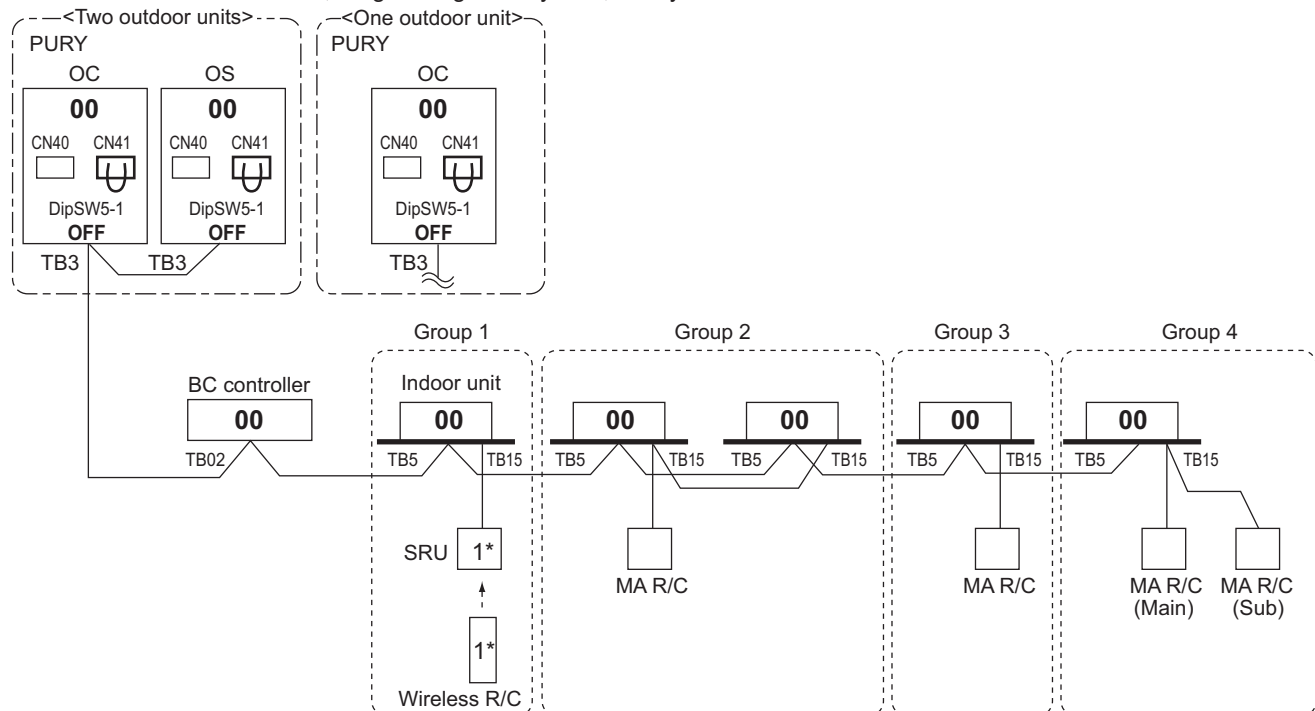

*1 For Wireless R/C and Signal receiver unit (SRU), channel 1, 2 and 3 are selectable and should be set to same channel.

NOTE:

1. Outdoor units OC and OS in one refrigerant circuit system are automatically detected.
OC and OS are ranked in descending order of capacity. If units are the same capacity, they are ranked in ascending order of their address.
2. No address setting is needed.
3. For a system having more than 32 indoor unit (P15-P140), confirm the need of Booster at 11-3. "System configuration restrictions".
4. Indoor units should be set with a branch number.
5. Address setting is required if a sub BC controller is connected.
6. When a PAR-CT01MA or PAR-3X MA-Series (X indicates 1, 2...) is connected to a group, no other MA remote controllers can be connected to the same group.

PURY-P-Y(S)NW-A

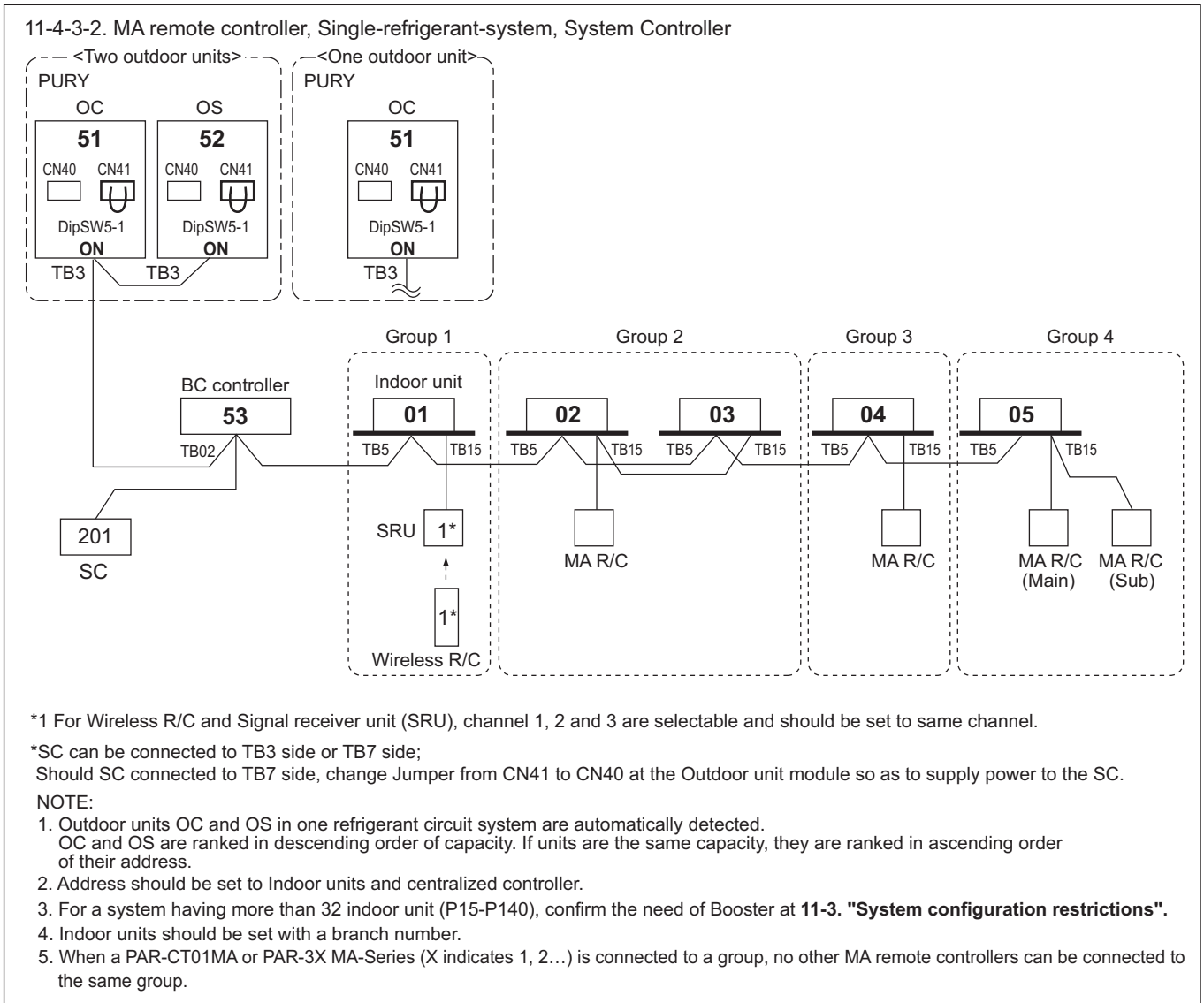

PURY-P-Y(S)NW-A

11-4-3-3. MA remote controller, Multi-refrigerant-system, System Controller at TB7/TB3 side, Booster for long M-NET wiring

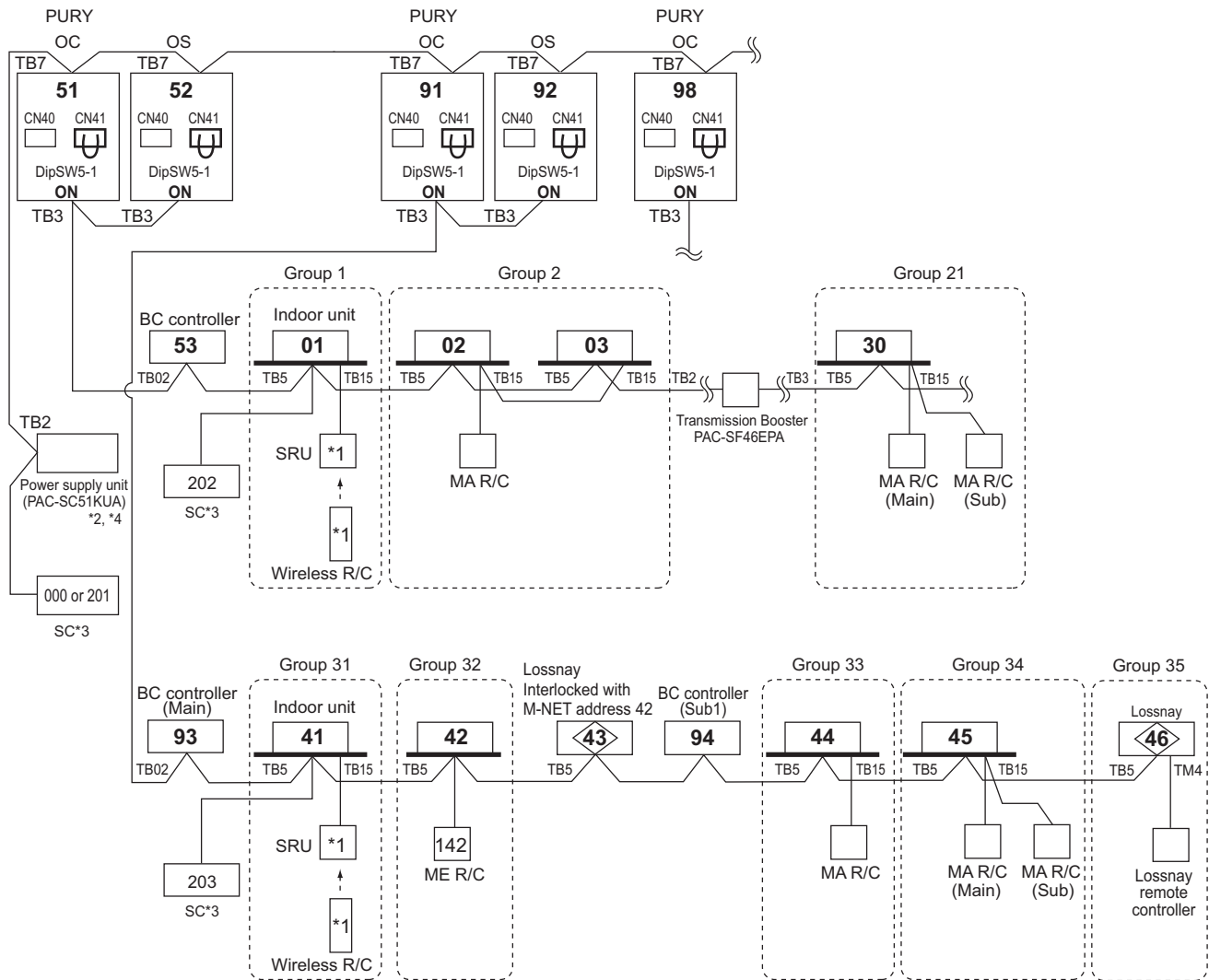

- *1 For Wireless R/C and Signal receiver unit (SRU), channel 1, 2 and 3 are selectable and should be set to same channel.
- *2 System controller should connect to TB7 at Outdoor and use power supply unit together in Multi-Refrigerant-System.
For AG-150A, 24VDC should be used with the PAC-SC51KUA.
For AE-200E, AE-50E, and EW-50E the power supply unit PAC-SC51KUA is unused.
- *3 When multiple system controllers are connected in the system, set the controller with more functions than others as a "main" controller and others as "sub".
AE-200E, AE-50E, EW-50E, BAC-HD150, and LM-AP are for exclusive use as a "main" system controller and cannot be used as a "sub" system controller.
Make the setting to only one of the system controllers for "prohibition of operation from local remote controller".
- *4 The power supply unit is not necessary for AE-200E, AE-50E, EW-50E, BAC-HD150, and LM-AP.

NOTE:

1. Outdoor units OC and OS in one refrigerant circuit system are automatically detected.
OC and OS are ranked in descending order of capacity. If units are the same capacity, they are ranked in ascending order of their address.
2. Address should be set to Indoor units, Lossnay, and system controller.
3. M-NET power is supplied by the Outdoor unit at TB3, while Indoor unit and ME remote controller consume the M-NET power for transmission use. The power balance is needed to consider for long M-NET wiring. Details refer to 11-3. "System configuration restrictions".
4. Indoor units should be set with a branch number.
5. Assign an address to each of the sub BC controllers which equals the sum of the smallest address of the indoor units that are connected to each sub BC controller and 50.
6. When a PAR-CT01MA or PAR-3X MA-Series (X indicates 1, 2...) is connected to a group, no other MA remote controllers can be connected to the same group.

PUY-P-Y(S)NW-A

11-4-3-4. ME remote controller, Single-refrigerant-system, No system controller

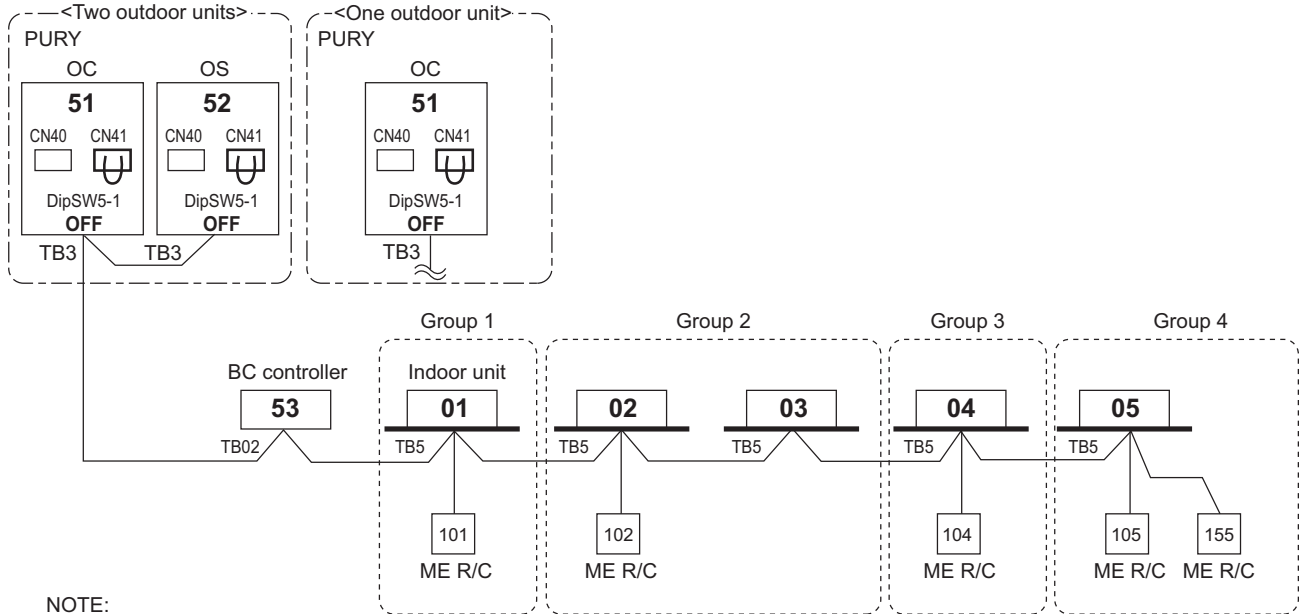

NOTE:

1. Outdoor units OC and OS in one refrigerant circuit system are automatically detected. OC and OS are ranked in descending order of capacity. If units are the same capacity, they are ranked in ascending order of their address.
2. Address should be set to Indoor units and ME remote controllers.
3. M-NET power is supplied by the Outdoor unit at TB3, while Indoor unit and ME RC consume the M-NET power for transmission use. The power balance is needed to consider for long M-NET wiring. Details refer to 11-3. "System configuration restrictions".
4. Indoor units should be set with a branch number.

11-4-3-5. ME remote controller, Single-refrigerant-system, System controller, Lossnay

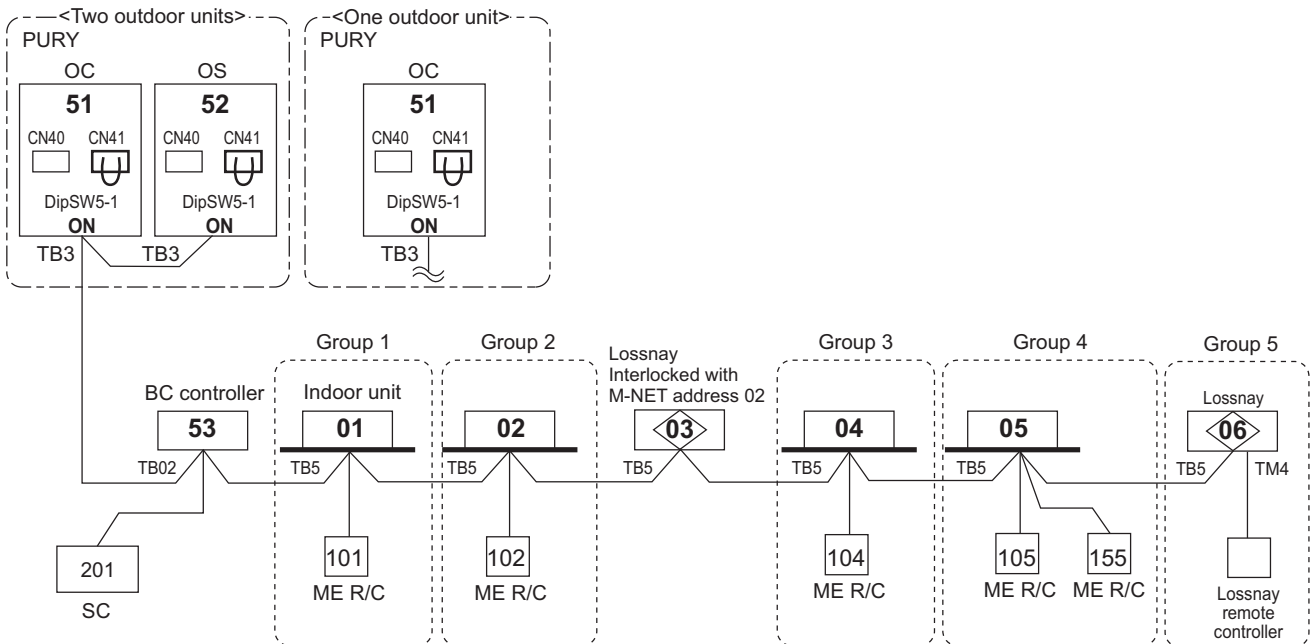

*SC can be connected to TB3 side or TB7 side;

Should SC connected to TB7 side, change Jumper from CN41 to CN40 at the Outdoor unit module so as to supply power to the SC.

NOTE:

1. Outdoor units OC and OS in one refrigerant circuit system are automatically detected. OC and OS are ranked in descending order of capacity. If units are the same capacity, they are ranked in ascending order of their address.
2. Address should be set to Indoor units, Lossnay, centralized controller, and ME remote controllers.
3. For a system having more than 32 indoor unit (P15-P140), confirm the need of Booster at 11-3. "System configuration restrictions".
4. Indoor units should be set with a branch number.

11-4-3-6. ME remote controller, Multi-refrigerant-system, System Controller at TB7 side, Lossnay, Booster for long M-NET wiring

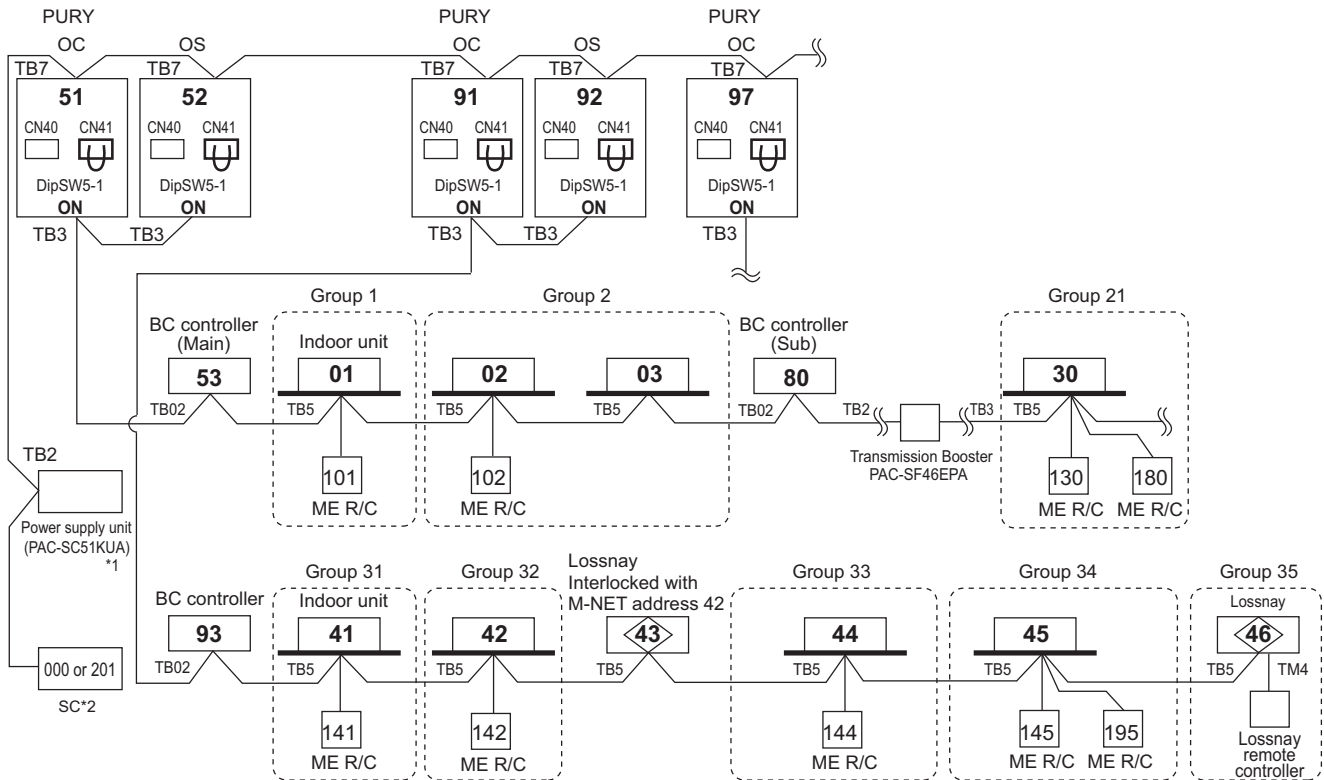

*1 System controller should connect to TB7 at Outdoor and use power supply unit together in Multi-Refrigerant-System.

For AG-150A, 24VDC should be used with the PAC-SC51KUA. For AE-200E, AE-50E, and EW-50E the power supply unit PAC-SC51KUA is unused.

*2 When multiple system controllers are connected in the system, set the controller with more functions than others as a "main" controller and others as "sub".

AG-150A, AE-200E, AE-50E, EW-50E, BAC-HD150, and LM-AP are for exclusive use as a "main" system controller and cannot be used as a "sub" system controller.

Make the setting to only one of the system controllers for "prohibition of operation from local remote controller".

NOTE:

- Outdoor units OC and OS in one refrigerant circuit system are automatically detected. OC and OS are ranked in descending order of capacity. If units are the same capacity, they are ranked in ascending order of their address.
- M-NET power is supplied by the Outdoor unit at TB3, while Indoor unit and ME RC consume the M-NET power for transmission use. The power balance is needed to consider for long M-NET wiring. Details refer to 11-3. "System configuration restrictions".
- Indoor units should be set with a branch number.
- Assign an address to each of the sub BC controllers which equals the sum of the smallest address of the indoor units that are connected to each sub BC controller and 50. When the address assigned to sub BC controller overlaps those of any other units including outdoor units (OC/OS) or main BC controller, sub BC controller will be given priority to have the address.

11-4-3-7. Example: BC, BC sub

- NOTE
- Indoor units should be set with a branch number.
 - BC (main) address = O/U address + 1
 - BC (sub) address = Lowest address within the indoor units connected to the BC controller (sub) + 50
 - If applicable, set the sub BC controllers in an PURY system in the following order:
 - Indoor unit to be connected to the BC controller (Main)
 - Indoor unit to be connected to the BC controller (No.1 Sub)
 - Indoor unit to be connected to the BC controller (No.2 Sub)
 Set the address so that (1)<(2)<(3)
 - A maximum of 12 BC controllers are connectable.

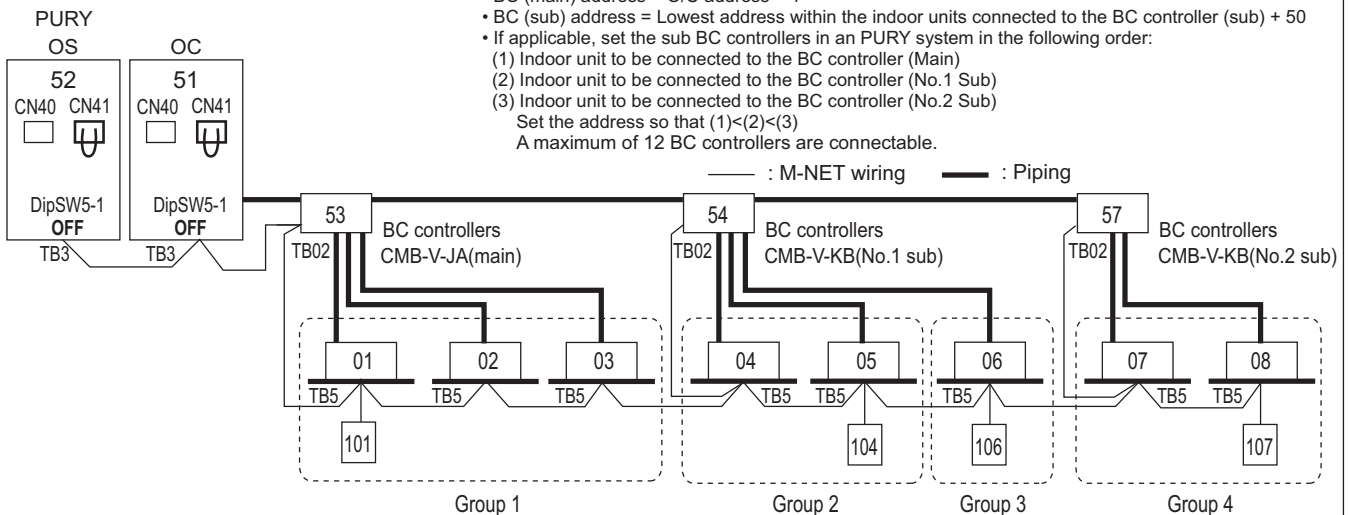

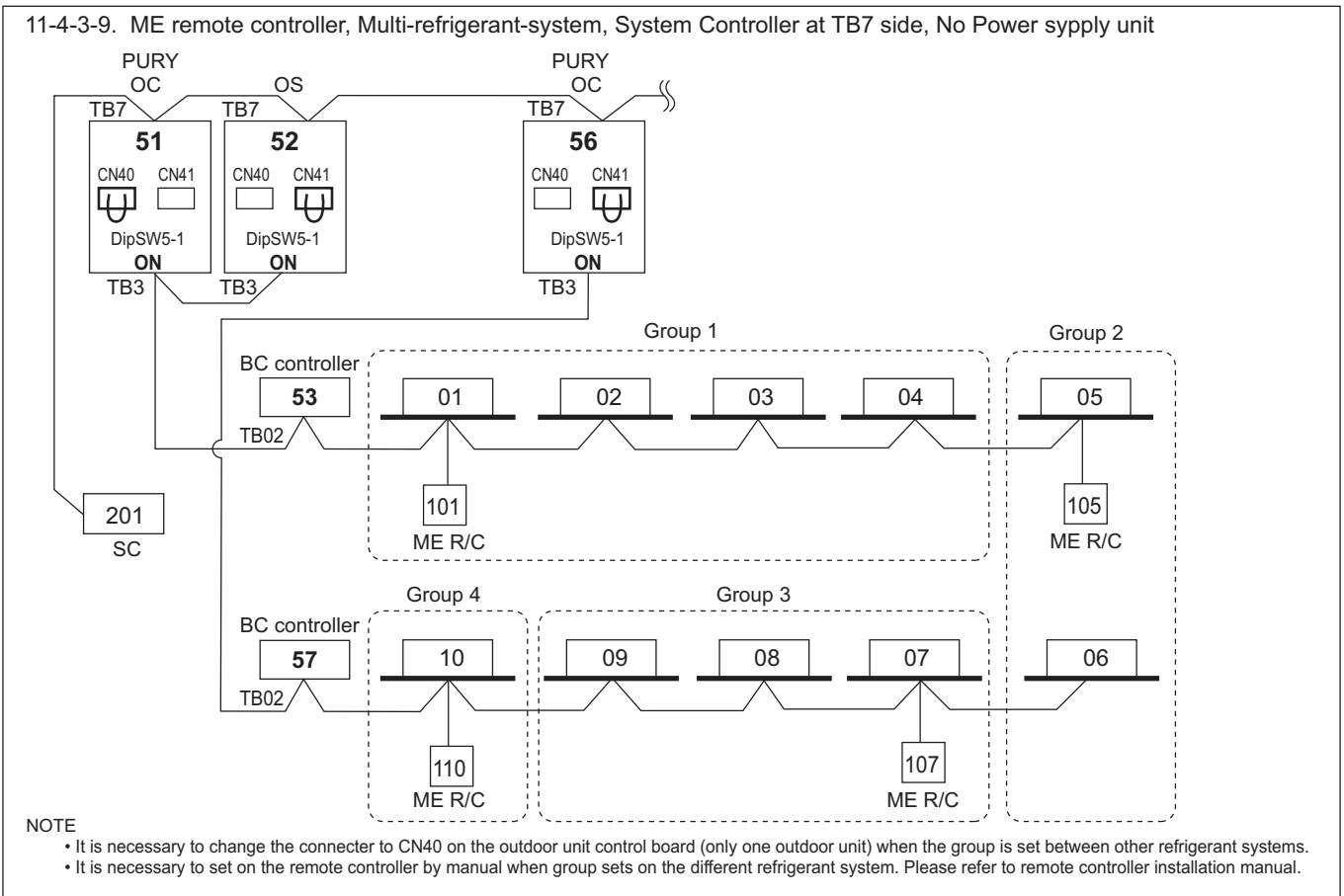
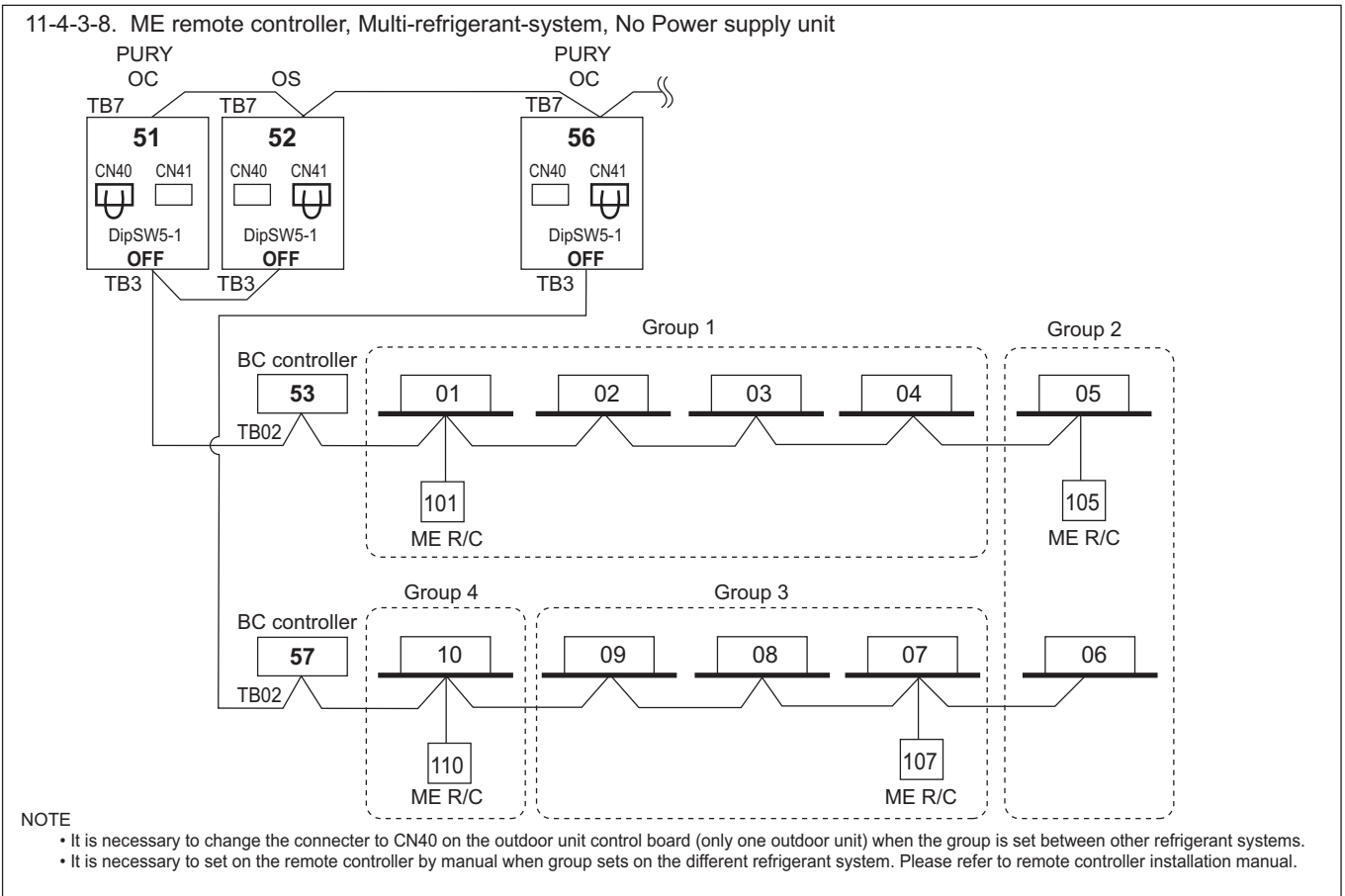

11-4-3-10. TG-2000A(*1)+AE-200E/AE-50E/EW-50E
 AE-200E can control max. 50 indoor units;
 TG-2000A can control max. 40 of AE-200E/AE-50E/EW-50E;*2
 TG-2000A can control max. 2000 indoor units.

PURY-P-Y(S)NW-A

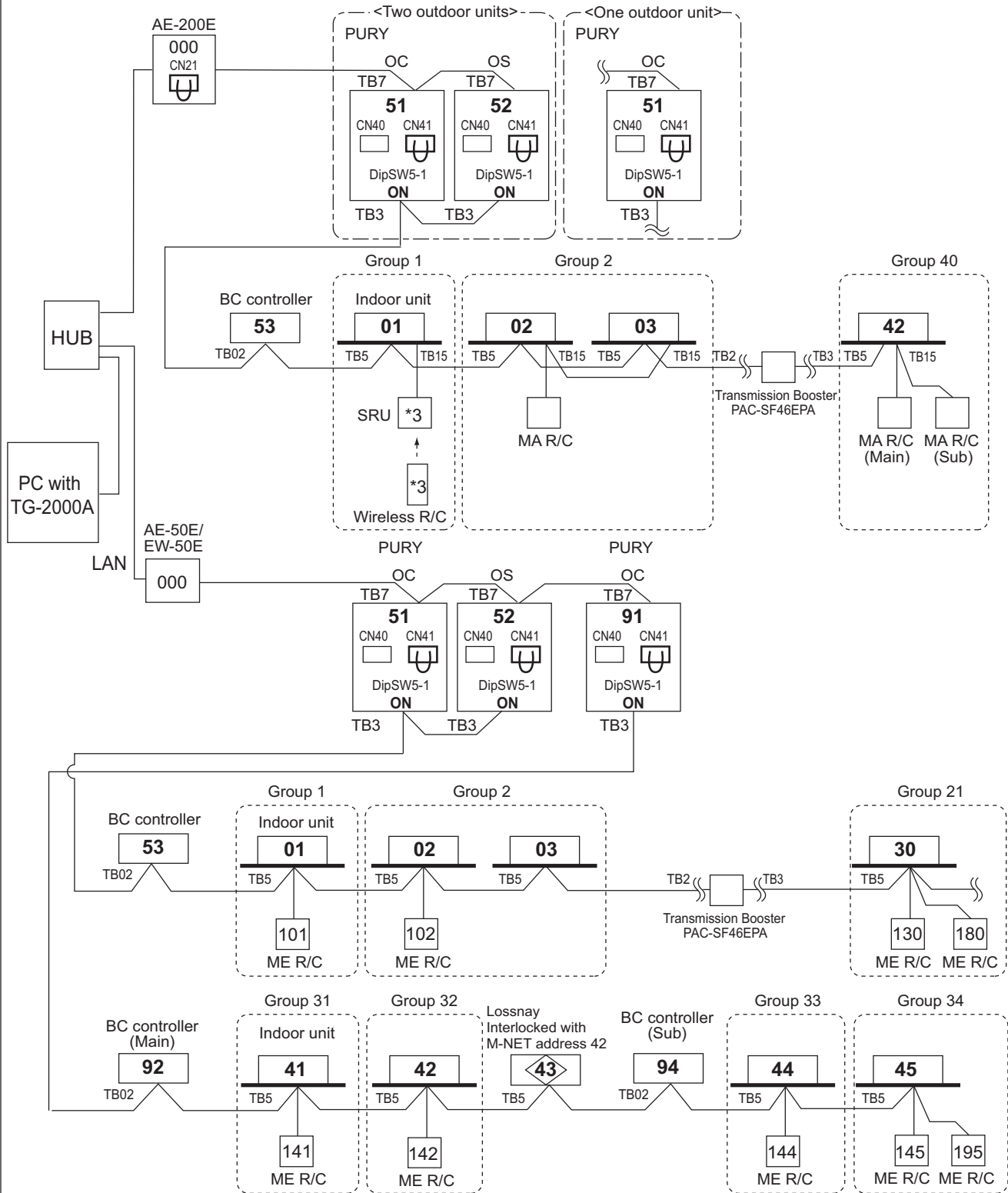

*1 TG-2000A (Ver.6.5 or later) supports AE-200E/AE-50E (Ver.7.10 or later).
 Contact your local distributor for which version of TG-2000A supports EW-50E.
 *2 When AE-200E connected with AE-50E is connected, the number of AE-50E will be the maximum controllable number.
 TG-2000A can control up to 40 AE-200E/AE-50E or AE-200E without AE-50E connection.
 *3 For Wireless R/C and Signal receiver unit (SRU), channel 1, 2 and 3 are selectable and should be set to same channel.
 *4 When a PAR-CT01MA or PAR-3X MA-Series (X indicates 1, 2...) is connected to a group, no other MA remote controllers can be connected to the same group.

11-4-3-11. AE-200E+AE-50E/EW-50E

AE-200E can control max. 200 indoor units/via AE-50E/EW-50E.

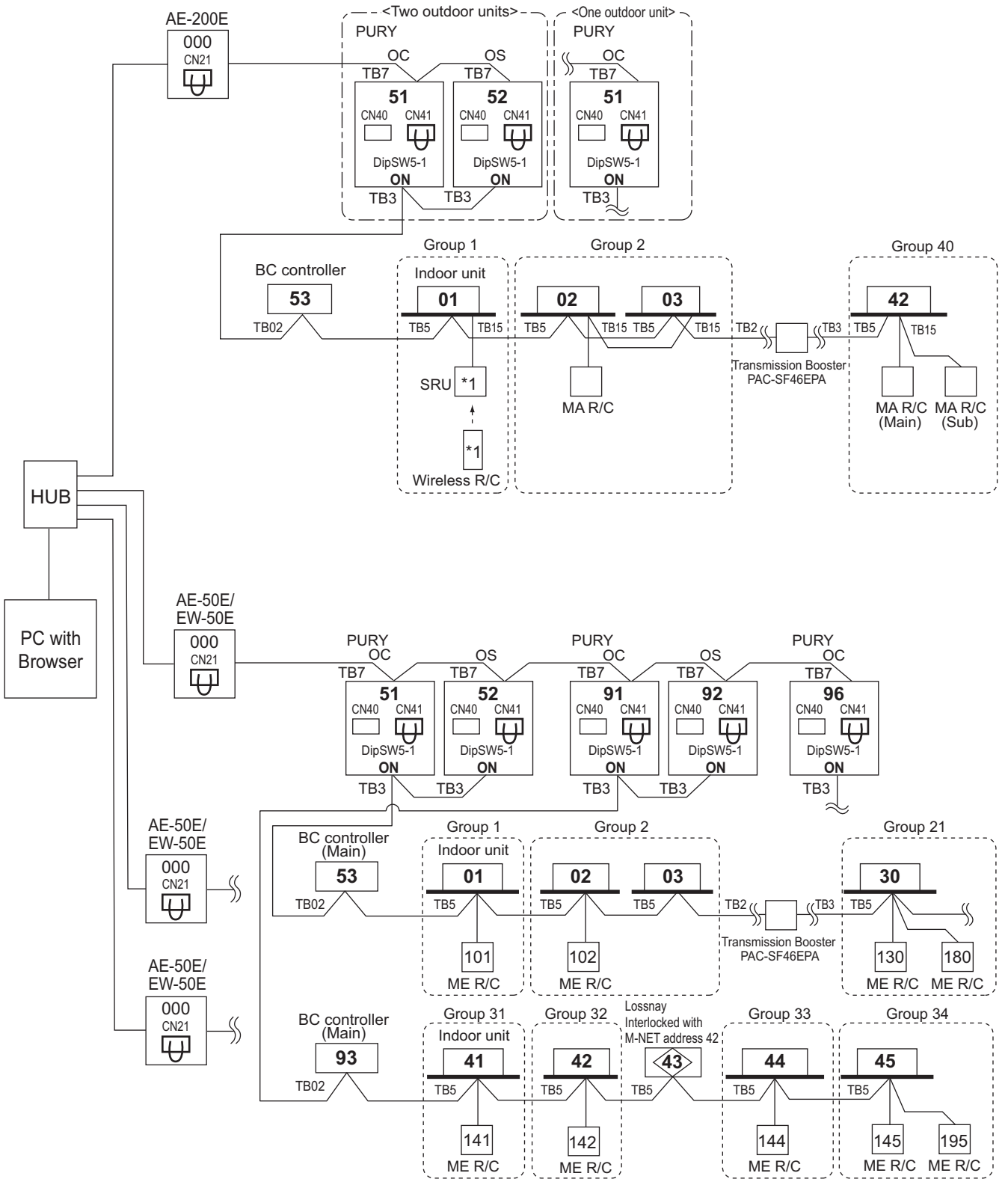

*1 For Wireless R/C and Signal receiver unit (SRU), channel 1, 2 and 3 are selectable and should be set to same channel.

*2 When a PAR-CT01MA or PAR-3X MA-Series (X indicates 1, 2...) is connected to a group, no other MA remote controllers can be connected to the same group.

PURV-P-Y(S)NW-A

11-4-3-12. LM-AP

LM-AP can transmit for max. 50 indoor units;

If system controller (SC) is used, DipSW1-2 at LM-AP and DipSW5-1 at Outdoor unit should set to "ON".

Change Jumper from CN41 to CN40 to activate power supply to LM-AP itself for those LM-AP connected without system controller (SC).

LM-AP can transmit for max. 50 indoor units in single-refrigerant-system or multi-refrigerant-system.

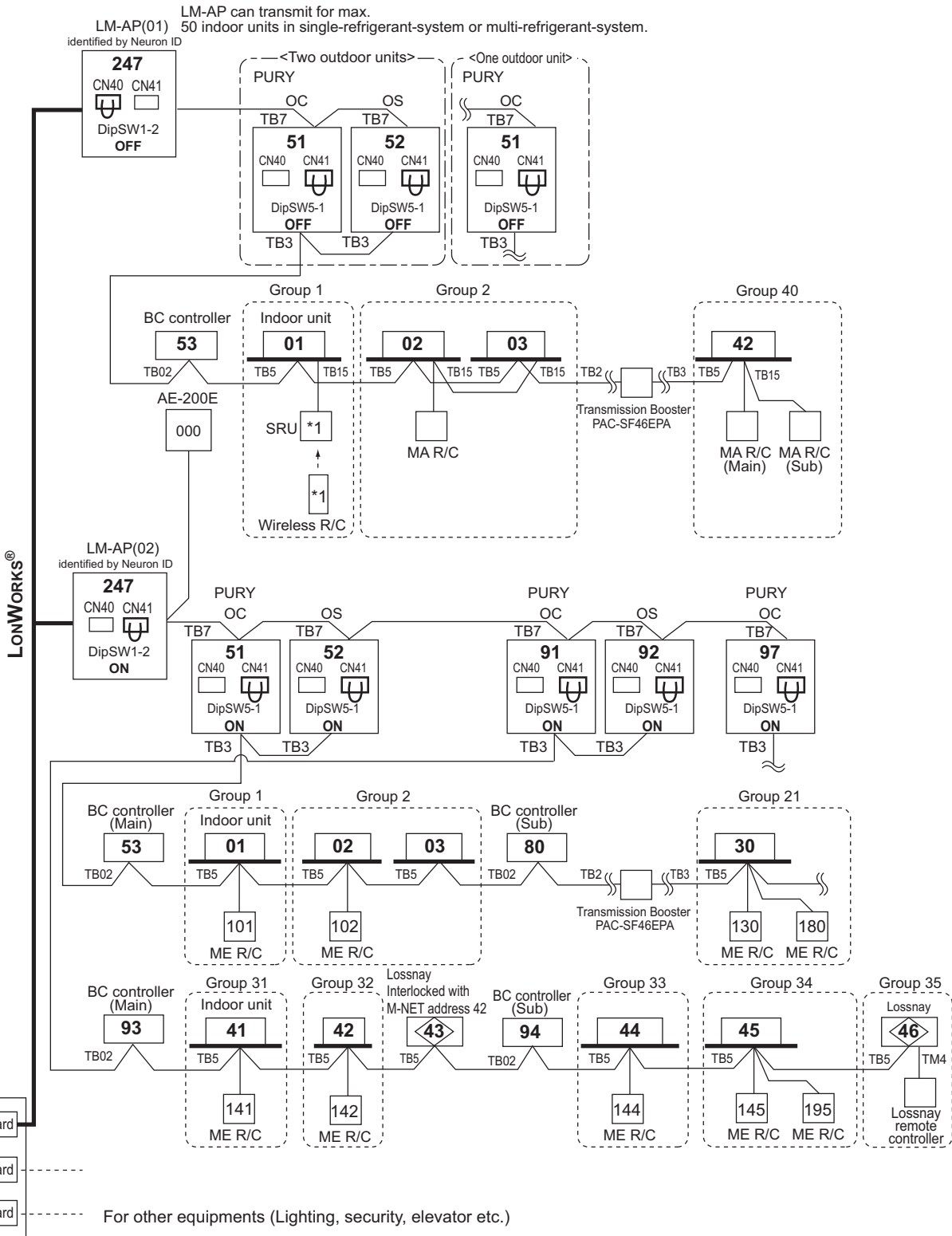

*1 For Wireless R/C and Signal receiver unit (SRU), channel 1, 2 and 3 are selectable and should be set to same channel.

*2 When a PAR-CT01MA or PAR-3X MA-Series (X indicates 1, 2...) is connected to a group, no other MA remote controllers can be connected to the same group.

PURY-P-Y(S)NW-A

11-4-3-13. BM ADAPTER+AE-200E/AE-50E/EW-50E

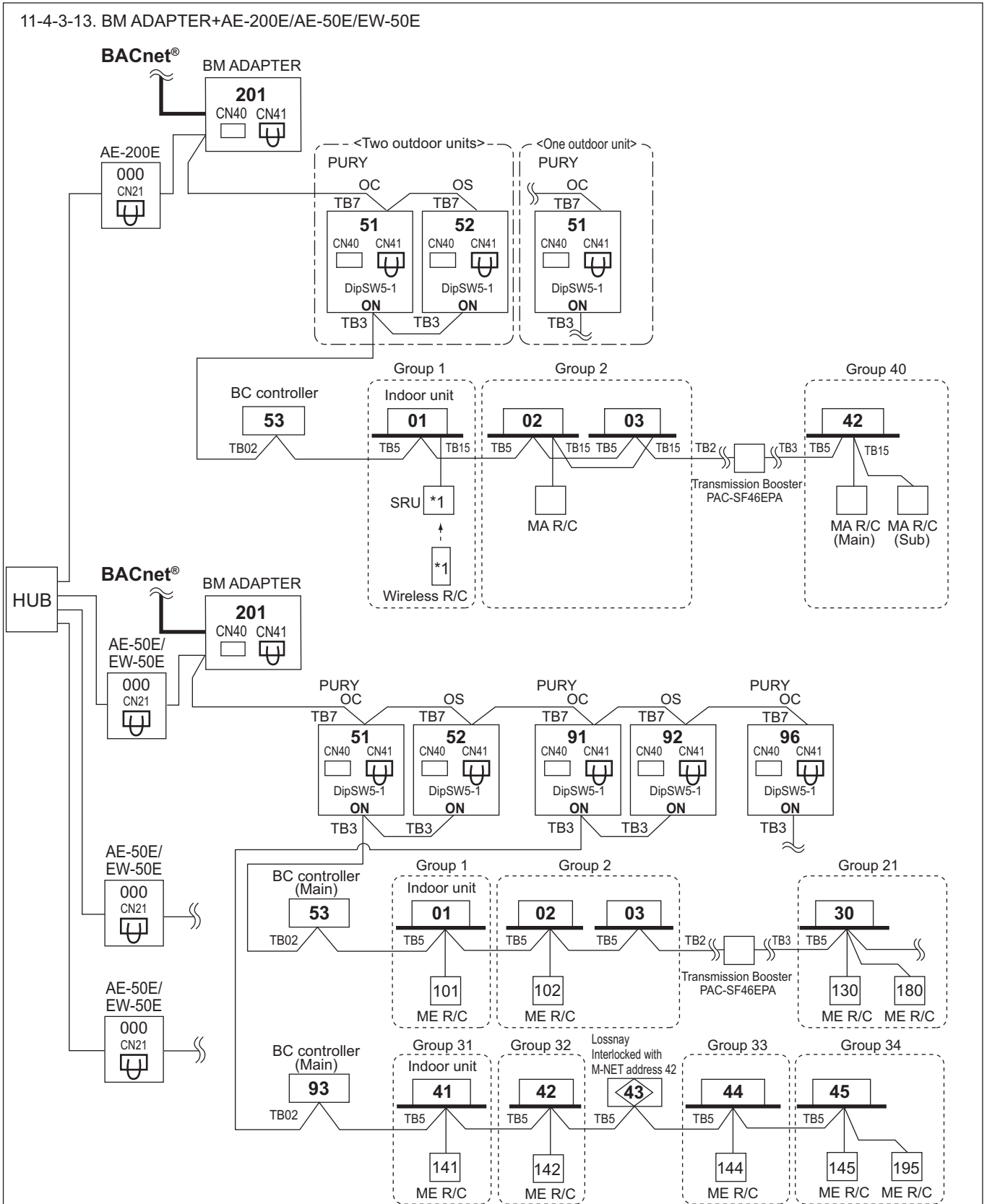

NOTE

- It is not necessary to connect the M-NET transmission line to the TB3 on BM ADAPTER. Leave the power jumper of BM ADAPTER connected to CN41.
- *1 For Wireless R/C and Signal receiver unit (SRU), channel 1, 2 and 3 are selectable and should be set to same channel.
- *2 Consult your dealer for restrictions when connecting both AE-200E/AE-50E/EW-50E and BM ADAPTER.
- *3 When a PAR-CT01MA or PAR-3X MA-Series (X indicates 1, 2, ...) is connected to a group, no other MA remote controllers can be connected to the same group.
- *4 In a system that uses AE-200E and/or AE-50E/EW-50E, each BM-ADAPTER must be connected to the M-NET line.

PUR-Y-P-Y(S)NW-A

Section 12-2.

Explains the piping design including piping length limitation and piping size selection rule.

12-1. R410A Piping material

Refrigerant pipe for CITY MULTI shall be made of phosphorus deoxidized copper, and has two types.

- A. Type-O: Soft copper pipe (annealed copper pipe), can be easily bent with human's hand.
- B. Type-1/2H pipe: Hard copper pipe (Straight pipe), being stronger than Type-O pipe of the same radical thickness.

The maximum operation pressure of R410A air conditioner is 4.30 MPa [623psi]. The refrigerant piping should ensure the safety under the maximum operation pressure. MITSUBISHI ELECTRIC recommends pipe size as Table1, or You shall follow the local industrial standard. Pipes of radical thickness 0.7mm or less shall not be used.

Table 1. Copper pipe size and radial thickness for R410A CITY MULTI.

Size (mm)	Size (inch)	Radial thickness (mm)	Radial thickness (mil)	Pipe type
ø6.35	ø1/4"	0.8	[32]	Type-O
ø9.52	ø3/8"	0.8	[32]	Type-O
ø12.7	ø1/2"	0.8	[32]	Type-O
ø15.88	ø5/8"	1.0	[40]	Type-O
ø19.05	ø3/4"	1.2	[48]	Type-O
ø19.05	ø3/4"	1.0	[40]	Type-1/2H or H
ø22.2	ø7/8"	1.0	[40]	Type-1/2H or H
ø25.4	ø1"	1.0	[40]	Type-1/2H or H
ø28.58	ø1-1/8"	1.0	[40]	Type-1/2H or H
ø31.75	ø1-1/4"	1.1	[44]	Type-1/2H or H
ø34.93	ø1-3/8"	1.2	[48]	Type-1/2H or H
ø41.28	ø1-5/8"	1.4	[56]	Type-1/2H or H

* For pipe sized ø19.05 (3/4") for R410A air conditioner, choice of pipe type is up to you.

* The figures in the radial thickness column are based on the Japanese standards and provided only as a reference. Use pipes that meet the local standards.

Flare

Due to the relative higher operation pressure of R410A compared to R22, the flare connection should follow dimensions mentioned below so as to achieve enough the air-tightness.

Flare pipe	Pipe size	A (For R410A) (mm[in.])	Flare nut	Pipe size	B (For R410A) (mm[in.])
	ø6.35 [1/4"]	9.1		ø6.35 [1/4"]	17.0
	ø9.52 [3/8"]	13.2		ø9.52 [3/8"]	22.0
	ø12.70 [1/2"]	16.6		ø12.70 [1/2"]	26.0
	ø15.88 [5/8"]	19.7		ø15.88 [5/8"]	29.0
	ø19.05 [3/4"]	24.0		ø19.05 [3/4"]	36.0

Procedures for installing the branched pipes

Refer to the instructions that came with the branched pipe kit (separately sold) for details.

[1] Branches on the indoor-unit side

- Restriction on installing the 2-Branch Joint Pipe CMY-Y202/302S-G2 on the gas piping

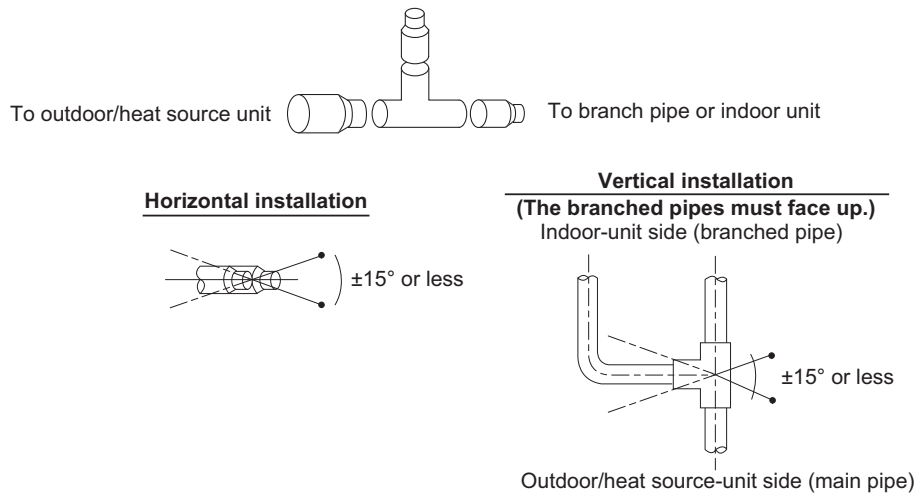

- CMY-Y202S-G2 and CMY-Y302S-G2 in the gas line must be installed horizontally (see figure above) or with the branched pipes facing up.
- If the size of the refrigerant pipe that is selected by following the instructions under “Piping Design” section does not match the size of the joint, use a reducer to connect them. A reducer is included in the kit.

- Restriction on installing the 2-Branch Joint Pipe CMY-R101/102S-G on the low-pressure piping

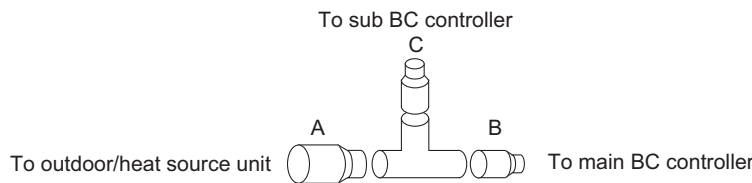

-Regarding the 2-Branch Joint Pipe on the low-pressure piping, A and B must be installed horizontally, and C must be installed upward higher than the horizontal plane of A and B.

- Restriction on installing the 2-Branch Joint Pipe CMY-R201/202/203/204/205S-G on the high-pressure piping, low-pressure piping, and liquid piping.

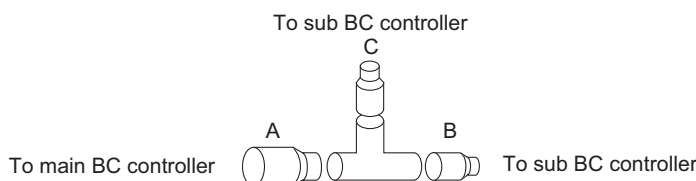

-Regarding the 2-Branch Joint Pipe on the high-pressure/low-pressure/liquid piping, A and B must be installed horizontally, and C must be installed upward higher than the horizontal plane of A and B.

[2] Branches on the outdoor/heat source-unit side

Note. Refer to the figure below for the installation position of the twinning pipe.

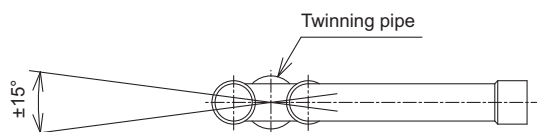

Slope of the twinning pipes are at an angle within $\pm 15^\circ$ to the horizontal plane.

- Inclination of the branched pipes

The inclination of the branched pipes must be $\pm 15^\circ$ or less against the horizontal plane. Excessive inclination of the branched pipes may damage the unit.

- Minimum length of the straight section of the pipe before the branched pipes

Always use the pipes supplied in the branched pipe kit, and make sure the straight section of the pipe immediately before it connects to the branched pipe is at least 500 mm (19-11/16 in.). Failure to do so may damage the unit.

12-2. Piping Design

"BC controller," "BC controller (Main)," and "BC controller (Sub)" that appear in this section refer to the J-type, JA/KA type, and KB type.

12-2-1. IF 16 ports or less are in use, i.e., if only one BC controller is in use with no sub BC controller

- Note1. No Header usable on PURY system.
- Note2. Indoor unit sized P100-P250 should be connected to BC controller via Y shape joint CMY-R160-J1 ; If the system consists only of PEFY-P50, 63, 71, 80, 100VMHS2-E models of indoor units, connect to the BC controller via Y-shape joint CMY-R160-J1.
- Note3. Indoor unit sized P100-P250 does NOT share BC controller ports with other Indoor units ;
- Note4. As bends cause pressure loss on transportation of refrigerant, fewer bends design is better ; Piping length needs to consider the actual length and equivalent length which bends are counted. Equivalent piping length (m)=Actual piping length+ "M" x Number of bent.
- Note5. Set DIP-SW 4-6 to ON of BC controller, in case of connected Indoor unit sized P100-P250 with 2 ports. If the system consists only of PEFY-P50, 63, 71, 80, 100VMHS2-E models of indoor units, set the dipswitches SW4-1 and SW4-6 on the BC controller to ON.
- Note6. It is also possible to connect indoor unit sized P100-P140 with 1 port (set DIP-SW 4-1 and 4-6 to OFF). PEFY-P50, 63, 71, 80, 100VMHS2-E models of indoor units can be connected to the system using a single port. However, the cooling capacity decreases a little (For details, refer to the chapter OUTDOOR UNITS, 8-5. Correction by port counts of the BC controller).
- Note7. Do not connect multiple indoor units to the same port when operating each of them in different mode (cooling, heating, stop, and thermo-off). The indoor units connected to the same port must be set to operate in the same mode. Set them in the same group to make them run/stop in the same mode all together. For other options, enable the thermo setting on the remote controller, or set the common thermostat (optional) to run/stop the units in the same mode based on a representative temperature.
- Note8. Indoor capacity is described as its model size. For example, PEFY-P63VML-E, its capacity is P63.
- Note9. Total down-stream Indoor capacity is the summary of the model size of Indoors down-stream. For example, PEFY-P63VML-E + PEFY-P32VML-E: Total Indoor capacity = P63 + P32 = P95.
- Note10. To enable the continuous heating mode, set SW4 (848) to ON.
- Note11. To connect the BC controller to the main pipe, use the reducer (CMY-R301S-G, CMY-R302S-G, or CMY-R304S-G).
- Note12. Install the pipes correctly referring to the section titled "Procedures for installing the branched pipes."

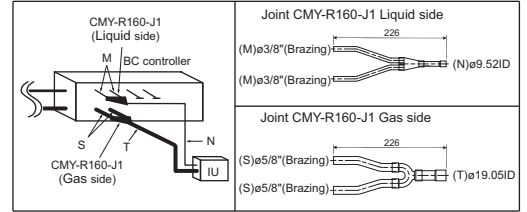

Fig. 12-2-1AA

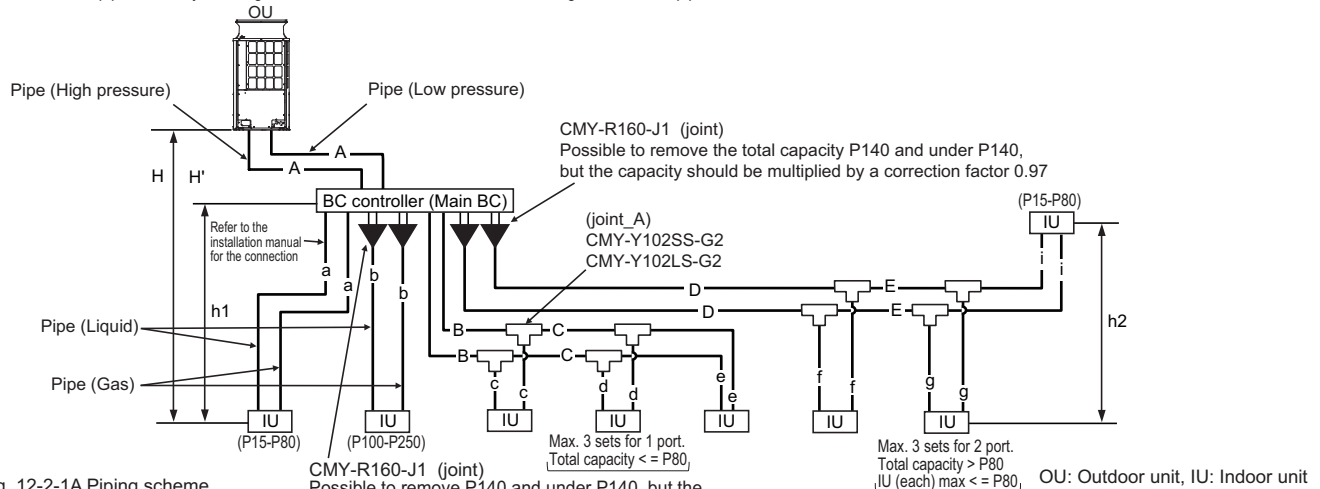

Fig. 12-2-1A Piping scheme

Piping length limitation *9

Item	Piping in the figure	Max. length	Max. equivalent length
Total piping length (Total length of high pressure and liquid pipes)	A+B+C+D+E+a+b+c+d+e+f+g+i	*1	-
Farthest IU from OU	A+D+E+i	165 [541]	190 [623]
Distance between OU and BC	A	110 [360] *1	110 [360] *1
Farthest IU from BC controller	D+E+i	60 [197] *2*3	60 [197] *2*3
Height between OU and IU (OU above IU)	H	50 [164] *6	-
Height between OU and IU (OU under IU)	H'	40 [131] *7	-
Height between IU and BC	h1	15 [49] (10 [32]) *4	-
Height between IU and IU	h2	30 [98] (20 [65]) *5	-

OU: Outdoor Unit; IU: Indoor Unit; BC: BC controller

- *1. Refer to the section 12-2-4.
- *2. Details refer to Fig. 1.
- *3. When the P200 or P250 model of indoor units are connected to the system, the maximum distance from the BC controller to the farthest indoor unit (indicated as "D + E + i" in the figure is 40 meters.)
- *4. Distance of Indoor sized P200, P250 from BC must be less than 10 m, if any.
- *5. Distance of Indoor sized P200, P250 from IU must be less than 20 m, if any.
- *6. 90 m is available depending on the model and installation conditions. For more detailed information, contact your local distributor.
- *7. 60 m is available depending on the model and installation conditions. For more detailed information, contact your local distributor.
- *8. When the high pressure piping length is 65 m or less, use $\phi 22.2$ ($\phi 7/8$) pipe. When the high pressure piping length exceeds 65 m, use $\phi 28.58$ ($\phi 1-1/8$) pipe for the part that exceeds 65 m.
- *9. Total length of high-pressure pipes and liquid pipes

Fig. 1 Piping length and height between IU and BC controller

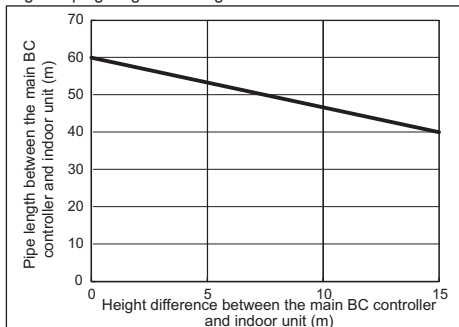

Bent equivalent length

Outdoor Model	m/bent [ft./bent]
P200YNW-A	0.35 [1.15]
P250YNW-A	0.42 [1.38]
P300YNW-A	0.42 [1.38]
P350YNW-A	0.47 [1.54]
P400YNW-A	0.50 [1.64]
P450YNW-A	0.50 [1.64]
P500YNW-A	0.50 [1.64]
P550YNW-A	0.50 [1.64]

Piping "A" size selection rule

Outdoor Model	Pipe(High pressure)	Pipe(Low pressure)
P200YNW-A	$\phi 15.88$ [5/8"]	$\phi 19.05$ [3/4"]
P250YNW-A	$\phi 19.05$ [3/4"]	$\phi 22.20$ [7/8"]
P300YNW-A	$\phi 19.05$ [3/4"]	$\phi 22.20$ [7/8"]
P350YNW-A	$\phi 19.05$ [3/4"]	$\phi 28.58$ [1-1/8"]
P400YNW-A	$\phi 22.20$ [7/8"]	$\phi 28.58$ [1-1/8"]
P450YNW-A	$\phi 22.20$ [7/8"]	$\phi 28.58$ [1-1/8"]
P500YNW-A	$\phi 22.20$ [7/8"]	$\phi 28.58$ [1-1/8"]
P550YNW-A	$\phi 22.20$ [7/8"] *8	$\phi 28.58$ [1-1/8"]

Piping "B", "C", "D", "E" size selection rule

Total down-stream Indoor capacity	Pipe(Liquid)	Pipe(Gas)
P140 or less	$\phi 9.52$ [3/8"]	$\phi 15.88$ [5/8"]
P141-P200	$\phi 9.52$ [3/8"]	$\phi 19.05$ [3/4"]
P201-P250	$\phi 9.52$ [3/8"]	$\phi 22.20$ [7/8"]

Piping "a", "b", "c", "d", "e", "f", "g", "i" size selection rule

Indoor Unit size	Pipe(Liquid)	Pipe(Gas)
P15 to P50, GUF-50RD(H)	$\phi 6.35$ [1/4"]	$\phi 12.70$ [1/2"]
P63 to P140, GUF-100RD(H)	$\phi 9.52$ [3/8"]	$\phi 15.88$ [5/8"]
P200	$\phi 9.52$ [3/8"]	$\phi 19.05$ [3/4"]
P250	$\phi 9.52$ [3/8"]	$\phi 22.20$ [7/8"]

Selection criteria for joints A

Total down-stream Indoor capacity	Joint
-P200	CMY-Y102SS-G2
P201-P250	CMY-Y102LS-G2

12-2-2. IF more than 16 ports are in use, or if there is more than one BC controller in use for one outdoor unit

- Note1. No Header usable on PURY system.
- Note2. Indoor unit sized P100-P250 should be connected to BC controller via Y shape joint CMY-R160-J1 ; If the system consists only of PEFY-P50, 63, 71, 80, 100VMHS2-E models of indoor units, connect to the BC controller via Y-shape joint CMY-R160-J1.
- Note3. Indoor unit sized P100-P250 does NOT share BC controller ports with other Indoor units ;
- Note4. As bents cause pressure loss on transportation of refrigerant, fewer bents design is better ; Piping length needs to consider the actual length and equivalent length which bents are counted. Equivalent piping length (m)=Actual piping length**M* x Number of bent.
- Note5. Set DIP-SW 4-6 to ON of BC controller, in case of connected Indoor unit sized P100-P250 with 2 ports. If the system consists only of PEFY-P50, 63, 71, 80, 100VMHS2-E models of indoor units, set the dipswitches SW4-1 and SW4-6 on the BC controller to ON.
- Note6. It is also possible to connect Indoor unit sized P100-P140 with 1 port (set DIP-SW 4-1 and 4-6 to OFF). PEFY-P50, 63, 71, 80, 100VMHS2-E models of indoor units can be connected to the system using a single port. However, the cooling capacity decreases a little (For details, refer to the chapter OUTDOOR UNITS, 8-5. Correction by port counts of the BC controller).
- Note7. Do not connect multiple indoor units to the same port when operating each of them in different mode (cooling, heating, stop, and thermo-off). The indoor units connected to the same port must be set to operate in the same mode. Set them in the same group to make them run/stop in the same mode all together. For other options, enable the thermo setting on the remote controller, or set the common thermostat (optional) to run/stop the units in the same mode based on a representative temperature.
- Note8. The maximum total capacity of indoor units that can be connected to each sub BC controller CMB-P-V-KB is 350.
- Note9. Indoor capacity is described as its model size. For example, PEFY-P63VML-E, its capacity is P63.
- Note10. Total down-stream Indoor capacity is the summary of the model size of Indoors down-stream. For example, PEFY-P63VML-E + PEFY-P32VML-E : Total Indoor capacity = P63 + P32 = P95.
- Note11. To enable the continuous heating mode, set SW4 (848) to ON.
- Note12. To connect the BC controller to the main pipe, use the reducer (CMY-R301S-G, CMY-R302S-G, or CMY-R304S-G).
- Note13. To connect the sub BC controller to the main BC controller, use the reducer (CMY-R303S-G, CMY-R305S-G, or CMY-R306S-G).
- Note14. Install the pipes correctly referring to the section titled "Procedures for installing the branched pipes."

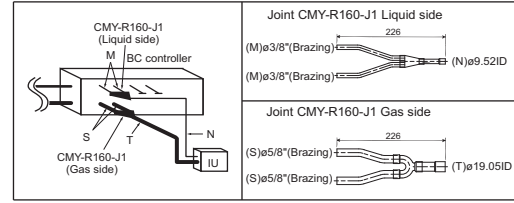

Fig. 12-2-2AA

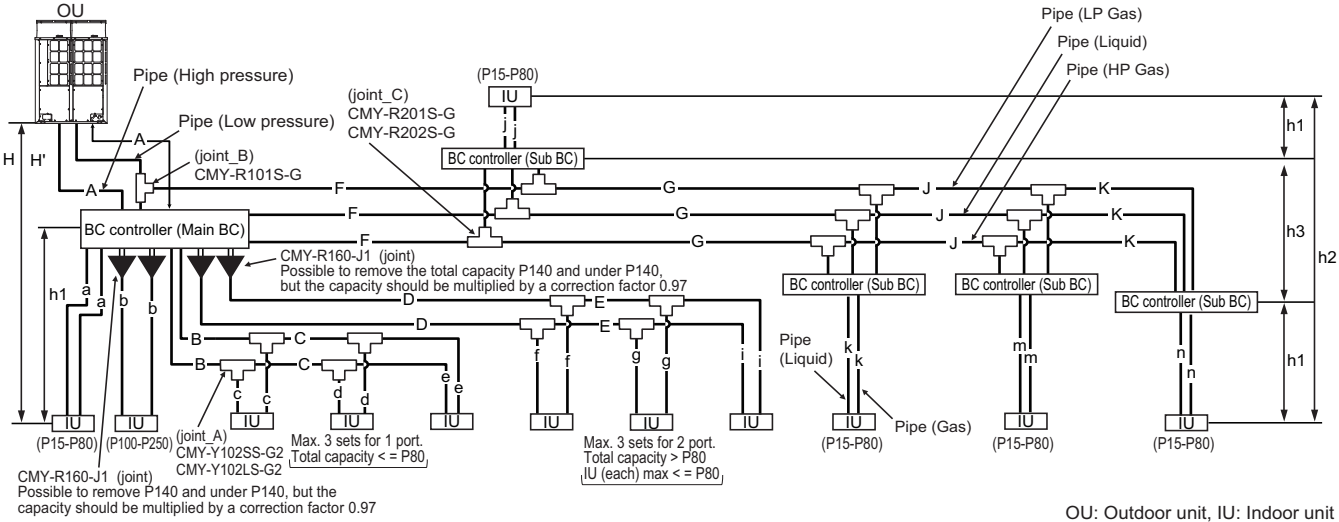

Fig. 12-2-2A Piping scheme

Piping length limitation *11

Item	Piping in the figure	Max. length	Max. equivalent length
Total piping length (Total length of high pressure and liquid pipes)	A+B+C+D+E+F+G+J+K+a+b+c+d+e+f+g+i+j+k+m+n	*1	-
Farthest IU from OU	A+F+G+J+K+n	165 [541']	190 [623']
Distance between OU and BC	A	110 [360'] *1	110 [360'] *1
Farthest IU from BC controller	D+E+i	60 [197'] *2*3	60 [197'] *2*3
Farthest IU from BC controller via Sub BC controller	F+G+J+K+n	90 [295'] *9	90 [295'] *9
Height between OU and IU (OU above IU)	H	50 [164'] *7	-
Height between OU and IU (OU under IU)	H'	40 [131'] *8	-
Height between IU and BC	h1	15 [49'] (10 [32']) *4	-
Height between IU and IU	h2	30 [98'] (20 [65']) *5	-
Height between BC(Main or Sub) and BC(Sub)	h3	15 [49'] (10 [32']) *6	-

OU: Outdoor Unit; IU: Indoor Unit; BC: BC controller

- *1. Refer to the section 12-2-4.
- *2. Details refer to Fig. 2.
- *3. When the P200 or P250 model of indoor units are connected to the system, the maximum distance from the BC controller to the farthest indoor unit (indicated as "D + E + i" in the figure is 40 meters.)
- *4. Distance of Indoor sized P200, P250 from BC must be less than 10 m, if any.
- *5. Distance of Indoor sized P200, P250 from IU must be less than 20 m, if any.
- *6. When using 2 Sub BC controllers, max. height "h3" should be considered.
- *7. 90 m is available depending on the model and installation conditions. For more detailed information, contact your local distributor.
- *8. 60 m is available depending on the model and installation conditions. For more detailed information, contact your local distributor.
- *9. When the piping length or the vertical separation exceeds the limit specified in Fig. 2, connect a sub BC to the system. The restriction for a system with a sub BC connection is shown in Fig. 3. When a given system configuration falls within the shaded area in Fig. 3, increase the size of the high-pressure pipe and the liquid pipe between the main BC and sub BC by one size. When using P32, P40, P50, P100, or P125 model of indoor units, increase the size of the liquid branch pipe between the sub BC and indoor unit by one size. When using indoor models P140 or larger, the restrictions shown in Fig. 2 cannot be exceeded.
- *10. When the high pressure piping length is 65 m or less, use ø22.2 (ø7/8) pipe. When the high pressure piping length exceeds 65 m, use ø28.58 (ø1-1/8) pipe for the part that exceeds 65 m.
- *11. Total length of high-pressure pipes and liquid pipes

Bent equivalent length

Outdoor Model	m/bent [ft./bent]
P200YNW-A	0.35 [1.15']
P250YNW-A	0.42 [1.38']
P300YNW-A	0.42 [1.38']
P350YNW-A	0.47 [1.54']
P400YNW-A	0.50 [1.64']
P450YNW-A	0.50 [1.64']
P500YNW-A	0.50 [1.64']
P550YNW-A	0.50 [1.64']

Piping length and height between IU and BC controller

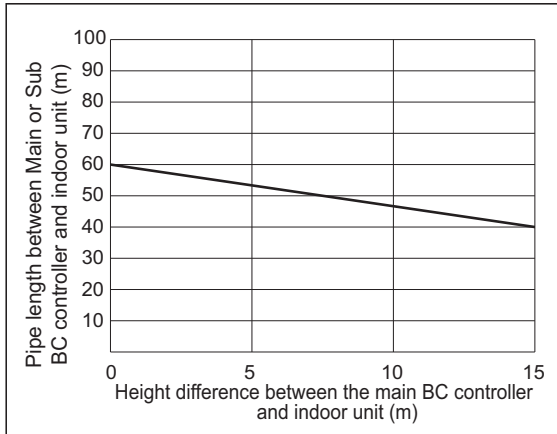

Fig. 2

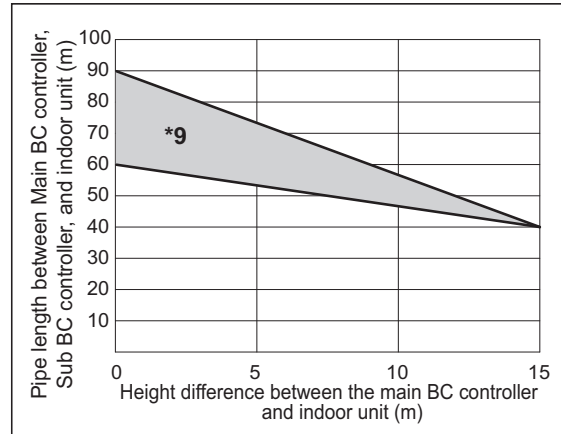
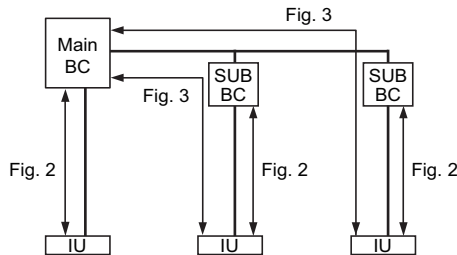

Fig. 3



*9. When the piping length or the vertical separation exceeds the limit specified in Fig. 2, connect a sub BC to the system. The restriction for a system with a sub BC connection is shown in Fig. 3. When a given system configuration falls within the shaded area in Fig. 3, increase the size of the high-pressure pipe and the liquid pipe between the main BC and sub BC by one size. When using P32, P40, P50, P100, or P125 model of indoor units, increase the size of the liquid branch pipe between the sub BC and indoor unit by one size. When using indoor models P140 or larger, the restrictions shown in Fig. 2 cannot be exceeded.

Piping "A" size selection rule

Outdoor Model	(mm [in.])	
	Pipe(High pressure)	Pipe(Low pressure)
P200YNW-A	ø15.88 [5/8"]	ø19.05 [3/4"]
P250YNW-A	ø19.05 [3/4"]	ø22.20 [7/8"]
P300YNW-A	ø19.05 [3/4"]	ø22.20 [7/8"]
P350YNW-A	ø19.05 [3/4"]	ø28.58 [1-1/8"]
P400YNW-A	ø22.20 [7/8"]	ø28.58 [1-1/8"]
P450YNW-A	ø22.20 [7/8"]	ø28.58 [1-1/8"]
P500YNW-A	ø22.20 [7/8"]	ø28.58 [1-1/8"]
P550YNW-A	ø22.20 [7/8"] *10	ø28.58 [1-1/8"]

Piping "B", "C", "D", "E" size selection rule

Total down-stream Indoor capacity	(mm [in.])	
	Pipe(Liquid)	Pipe(Gas)
P140 or less	ø9.52 [3/8"]	ø15.88 [5/8"]
P141-P200	ø9.52 [3/8"]	ø19.05 [3/4"]
P201-P250	ø9.52 [3/8"]	ø22.20 [7/8"]

Piping "a", "b", "c", "d", "e", "f", "g", "i", "j", "k", "m", "n" size selection rule (mm [in.])

Indoor Unit size	Pipe(Liquid)	Pipe(Gas)
P15 to P50, GUF-50RD(H)	ø6.35 [1/4"]	ø12.70 [1/2"]
P63 to P140, GUF-100RD(H)	ø9.52 [3/8"]	ø15.88 [5/8"]
P200	ø9.52 [3/8"]	ø19.05 [3/4"]
P250	ø9.52 [3/8"]	ø22.20 [7/8"]

Piping "F", "G", "J", "K" size selection rule

Total down-stream Indoor capacity	(mm [in.])		
	Pipe(Liquid)	Pipe(HP Gas)	Pipe(LP Gas)
P200 or less	ø9.52 [3/8"]	ø15.88 [5/8"]	ø19.05 [3/4"]
P201 to P300	ø9.52 [3/8"]	ø19.05 [3/4"]	ø22.20 [7/8"]
P301 to P350	ø12.70 [1/2"]	ø19.05 [3/4"]	ø28.58 [1-1/8"]
P351 to P400	ø12.70 [1/2"]	ø22.20 [7/8"]	ø28.58 [1-1/8"]
P401 to P600	ø15.88 [5/8"]	ø22.20 [7/8"]	ø28.58 [1-1/8"]
P601 to P650	ø15.88 [5/8"]	ø28.58 [1-1/8"]	ø28.58 [1-1/8"]
P651 to P800	ø19.05 [3/4"]	ø28.58 [1-1/8"]	ø34.93 [1-3/8"]
P801 to P1000	ø19.05 [3/4"]	ø28.58 [1-1/8"]	ø41.28 [1-5/8"]
P1001 or above	ø19.05 [3/4"]	ø34.93 [1-3/8"]	ø41.28 [1-5/8"]

HP: High pressure, LP: Low pressure

Selection criteria for joints_A

Total down-stream Indoor capacity	Joint
-P200	CMY-Y102SS-G2
P201-P250	CMY-Y102LS-G2

Selection criteria for joints_B

Outdoor Model	Joint
P200-P550YNW-A	CMY-R101S-G

Selection criteria for joints_C

Total down-stream Indoor capacity	Joint
-P350	CMY-R201S-G
P351-P550	CMY-R202S-G

12-2-3. IF more than 16 ports are in use, or if there is more than one BC controller in use for two outdoor units

- Note1. No Header usable on PURY system.
- Note2. Indoor unit sized P100-P250 should be connected to BC controller via Y shape joint CMY-R160-J1 ; If the system consists only of PEFY-P50, 63, 71, 80, 100VMHS2-E models of indoor units, connect to the BC controller via Y-shape joint CMY-R160-J1.
- Note3. Indoor unit sized P100-P250 does NOT share BC controller ports with other Indoor units ;
- Note4. As bents cause pressure loss on transportation of refrigerant, fewer bents design is better ; Piping length needs to consider the actual length and equivalent length which bents are counted. Equivalent piping length (m)=Actual piping length+"M" x Number of bent.
- Note5. Set DIP-SW 4-6 to ON of BC controller, in case of connected Indoor unit sized P100-P250 with 2 ports. If the system consists only of PEFY-P50, 63, 71, 80, 100VMHS2-E models of indoor units, set the dipswitches SW4-1 and SW4-6 on the BC controller to ON.
- Note6. It is also possible to connect Indoor unit sized P100-P140 with 1 port (set DIP-SW 4-1 and 4-6 to OFF). PEFY-P50, 63, 71, 80, 100VMHS2-E models of indoor units can be connected to the system using a single port. However, the cooling capacity decreases a little (For details, refer to the chapter OUTDOOR UNITS, 8-5. Correction by port counts of the BC controller).
- Note7. Do not connect multiple indoor units to the same port when operating each of them in different mode (cooling, heating, stop, and thermo-off). The indoor units connected to the same port must be set to operate in the same mode. Set them in the same group to make them run/stop in the same mode all together. For other options, enable the thermo setting on the remote controller, or set the common thermostat (optional) to run/stop the units in the same mode based on a representative temperature.
- Note8. The maximum total capacity of indoor units that can be connected to each sub BC controller CMB-P-V-KB is 350.
- Note9. Indoor capacity is described as its model size. For example, PEFY-P63VML-E, its capacity is P63.
- Note10. Total down-stream Indoor capacity is the summary of the model size of Indoors down-stream. For example, PEFY-P63VML-E + PEFY-P32VML-E : Total Indoor capacity = P63 + P32 = P95.
- Note11. To enable the continuous heating mode, set SW4 (848) to ON.
- Note12. To connect the BC controller to the main pipe, use the reducer (CMY-R301S-G, CMY-R302S-G, or CMY-R304S-G).
- Note13. To connect the sub BC controller to the main BC controller, use the reducer (CMY-R303S-G, CMY-R305S-G, or CMY-R306S-G).
- Note14. Install the pipes correctly referring to the section titled "Procedures for installing the branched pipes."

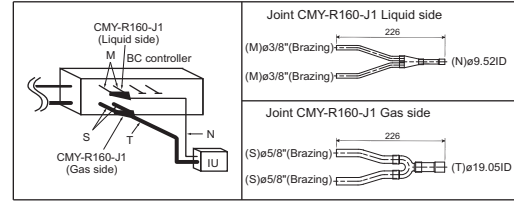
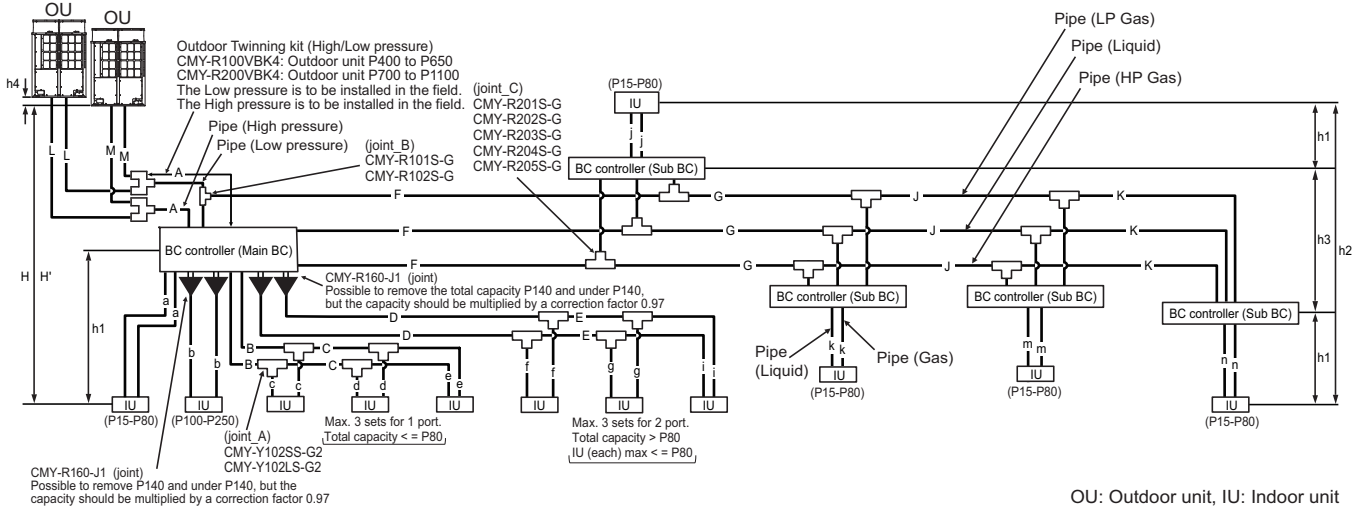

Fig. 12-2-3AA



OU: Outdoor unit, IU: Indoor unit

Fig. 12-2-3A Piping scheme

Piping length limitation *11

Item	Piping in the figure	Max. length	Max. equivalent length (m [ft.])
Total piping length (Total length of high pressure and liquid pipes)	L+M+A+B+C+D+E+F+G+J+K+a+b+c+d+e+f+g+h+i+j+k+m+n	*1	-
Farthest IU from OU	L(M)+A+F+G+J+K+n	165 [541']	190 [623']
Distance between OU and BC	L(M)+A	110 [360'] *1	110 [360'] *1
Farthest IU from BC controller	D+E+i	60 [197'] *2 *3	60 [197'] *2*3
Farthest IU from BC controller via Sub BC controller	F+G+J+K+n	90 [295'] *9	90 [295'] *9
Height between OU and IU (OU above IU)	H	50 [164'] *7	-
Height between OU and IU (OU under IU)	H'	40 [131'] *8	-
Height between IU and BC	h1	15 [49'] (10 [32']) *4	-
Height between IU and IU	h2	30 [98'] (20 [65']) *5	-
Height between BC(Main or Sub) and BC(Sub)	h3	15 [49'] (10 [32']) *6	-
Distance between Main unit and Sub unit	L+M	5 [16']	-
Height between Main unit and Sub unit	h4	0.1 [0.3']	-

OU: Outdoor Unit; IU: Indoor Unit; BC: BC controller

- *1. Refer to the section 12-2-4.
- *2. Details refer to Fig. 2.
- *3. When the P200 or P250 model of indoor units are connected to the system, the maximum distance from the BC controller to the farthest indoor unit (indicated as "D + E + i" in the figure is 40 meters.)
- *4. Distance of Indoor sized P200, P250 from BC must be less than 10 m, if any.
- *5. Distance of Indoor sized P200, P250 from IU must be less than 20 m, if any.
- *6. When using 2 Sub BC controllers, max. height "h3" should be considered.
- *7. 90 m is available depending on the model and installation conditions. For more detailed information, contact your local distributor.
- *8. 60 m is available depending on the model and installation conditions. For more detailed information, contact your local distributor.
- *9. When the piping length or the vertical separation exceeds the limit specified in Fig. 2, connect a sub BC to the system. The restriction for a system with a sub BC connection is shown in Fig. 3. When a given system configuration falls within the shaded area in Fig. 3, increase the size of the high-pressure pipe and the liquid pipe between the main BC and sub BC by one size. When using P32, P40, P50, P100, or P125 model of indoor units, increase the size of the liquid branch pipe between the sub BC and indoor unit by one size. When using indoor models P140 or larger, the restrictions shown in Fig. 2 cannot be exceeded.
- *10. When the high pressure piping length is 65 m or less, use ø22.2 (ø7/8) pipe. When the high pressure piping length exceeds 65 m, use ø22.2 (ø7/8) pipe until 65 m, use ø28.58 (ø1-1/8) pipe for the part that exceeds 65 m.
- *11. Total length of high-pressure pipes and liquid pipes

Bent equivalent length

Outdoor Model	m/bent [ft./bent]
P400YSNW-A	0.50 [1.64']
P450YSNW-A	0.50 [1.64']
P500YSNW-A	0.50 [1.64']
P550YSNW-A	0.50 [1.64']
P600YSNW-A	0.50 [1.64']
P650YSNW-A	0.50 [1.64']
P700YSNW-A	0.70 [2.29']
P750YSNW-A	0.70 [2.29']
P800YSNW-A	0.70 [2.29']
P850YSNW-A	0.80 [2.62']
P900YSNW-A	0.80 [2.62']
P950YSNW-A	0.80 [2.62']
P1000YSNW-A	0.80 [2.62']
P1050YSNW-A	0.80 [2.62']
P1100YSNW-A	0.80 [2.62']

Piping length and height between IU and BC controller

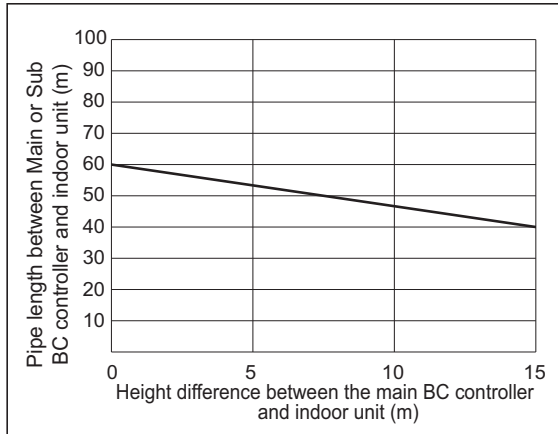

Fig. 2

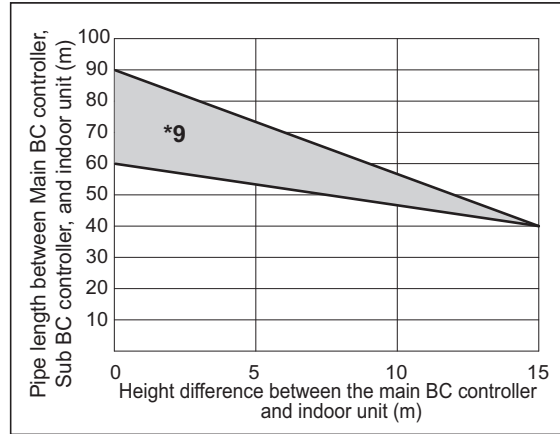
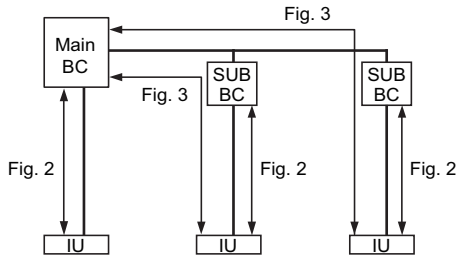

Fig. 3



*9. When the piping length or the vertical separation exceeds the limit specified in Fig. 2, connect a sub BC to the system.
 The restriction for a system with a sub BC connection is shown in Fig. 3.
 When a given system configuration falls within the shaded area in Fig. 3, increase the size of the high-pressure pipe and the liquid pipe between the main BC and sub BC by one size.
 When using P32, P40, P50, P100, or P125 model of indoor units, increase the size of the liquid branch pipe between the sub BC and indoor unit by one size.
 When using indoor models P140 or larger, the restrictions shown in Fig. 2 cannot be exceeded.

Piping "A" size selection rule (mm [in.]

Outdoor Model	Pipe(High pressure)	Pipe(Low pressure)
P400YSNW-A	ø22.20 [7/8"]	ø28.58 [1-1/8"]
P450YSNW-A	ø22.20 [7/8"]	ø28.58 [1-1/8"]
P500YSNW-A	ø22.20 [7/8"]	ø28.58 [1-1/8"]
P550YSNW-A	ø22.20 [7/8"] *10	ø28.58 [1-1/8"]
P600YSNW-A	ø22.20 [7/8"] *10	ø28.58 [1-1/8"]
P650YSNW-A	ø28.58 [1-1/8"]	ø28.58 [1-1/8"]
P700YSNW-A	ø28.58 [1-1/8"]	ø34.93 [1-3/8"]
P750YSNW-A	ø28.58 [1-1/8"]	ø34.93 [1-3/8"]
P800YSNW-A	ø28.58 [1-1/8"]	ø34.93 [1-3/8"]
P850YSNW-A	ø28.58 [1-1/8"]	ø41.28 [1-5/8"]
P900YSNW-A	ø28.58 [1-1/8"]	ø41.28 [1-5/8"]
P950YSNW-A	ø28.58 [1-1/8"]	ø41.28 [1-5/8"]
P1000YSNW-A	ø28.58 [1-1/8"]	ø41.28 [1-5/8"]
P1050YSNW-A	ø34.93 [1-3/8"]	ø41.28 [1-5/8"]
P1100YSNW-A	ø34.93 [1-3/8"]	ø41.28 [1-5/8"]

Piping "L", "M" size selection rule (mm [in.]

Outdoor Model	Pipe(High pressure)	Pipe(Low pressure)
P200YNW-A	ø15.88 [5/8"]	ø19.05 [3/4"]
P250YNW-A	ø19.05 [3/4"]	ø22.20 [7/8"]
P300YNW-A	ø19.05 [3/4"]	ø22.20 [7/8"]
P350YNW-A	ø19.05 [3/4"]	ø28.58 [1-1/8"]
P400YNW-A	ø22.20 [7/8"]	ø28.58 [1-1/8"]
P450YNW-A	ø22.20 [7/8"]	ø28.58 [1-1/8"]
P500YNW-A	ø22.20 [7/8"]	ø28.58 [1-1/8"]
P550YNW-A	ø22.20 [7/8"]	ø28.58 [1-1/8"]

Piping "B", "C", "D", "E" size selection rule (mm [in.]

Total down-stream Indoor capacity	Pipe(Liquid)	Pipe(Gas)
P140 or less	ø9.52 [3/8"]	ø15.88 [5/8"]
P141-P200	ø9.52 [3/8"]	ø19.05 [3/4"]
P201-P250	ø9.52 [3/8"]	ø22.20 [7/8"]

Selection criteria for joints_A

Total down-stream Indoor capacity	Joint
-P200	CMY-Y102SS-G2
P201-P250	CMY-Y102LS-G2

Piping "a", "b", "c", "d", "e", "f", "g", "i", "j", "k", "m", "n" size selection rule (mm [in.]

Indoor Unit size	Pipe(Liquid)	Pipe(Gas)
P15 to P50, GUF-50RD(H)	ø6.35 [1/4"]	ø12.70 [1/2"]
P63 to P140, GUF-100RD(H)	ø9.52 [3/8"]	ø15.88 [5/8"]
P200	ø9.52 [3/8"]	ø19.05 [3/4"]
P250	ø9.52 [3/8"]	ø22.20 [7/8"]

Selection criteria for joints_B

Outdoor Model	Joint
P400-P650YSNW-A	CMY-R101S-G
P700-P1100YSNW-A	CMY-R102S-G

Piping "F", "G", "J", "K" size selection rule (mm [in.]

Total down-stream Indoor capacity	Pipe(Liquid)	Pipe(HP Gas)	Pipe(LP Gas)
P200 or less	ø9.52 [3/8"]	ø15.88 [5/8"]	ø19.05 [3/4"]
P201 to P300	ø9.52 [3/8"]	ø19.05 [3/4"]	ø22.20 [7/8"]
P301 to P350	ø12.70 [1/2"]	ø19.05 [3/4"]	ø28.58 [1-1/8"]
P351 to P400	ø12.70 [1/2"]	ø22.20 [7/8"]	ø28.58 [1-1/8"]
P401 to P600	ø15.88 [5/8"]	ø22.20 [7/8"]	ø28.58 [1-1/8"]
P601 to P650	ø15.88 [5/8"]	ø28.58 [1-1/8"]	ø28.58 [1-1/8"]
P651 to P800	ø19.05 [3/4"]	ø28.58 [1-1/8"]	ø34.93 [1-3/8"]
P801 to P1000	ø19.05 [3/4"]	ø28.58 [1-1/8"]	ø41.28 [1-5/8"]
P1001 or above	ø19.05 [3/4"]	ø34.93 [1-3/8"]	ø41.28 [1-5/8"]

Selection criteria for joints_C

Total down-stream Indoor capacity	Joint
-P350	CMY-R201S-G
P351-P600	CMY-R202S-G
P601-P650	CMY-R203S-G
P651-P1000	CMY-R204S-G
P1001-	CMY-R205S-G

HP: High pressure, LP: Low pressure

12-2-4. Total piping length restrictions

[PURY-P200, 250, 300YNW-A]

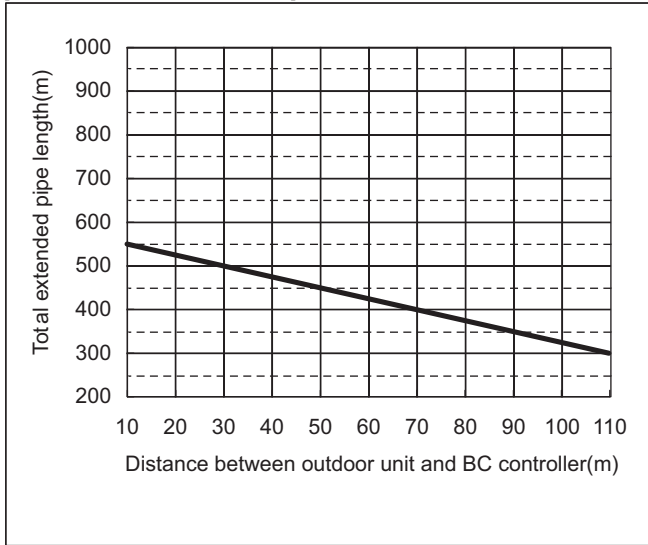

[PURY-P350, 400, 450, 500, 550YNW-A]

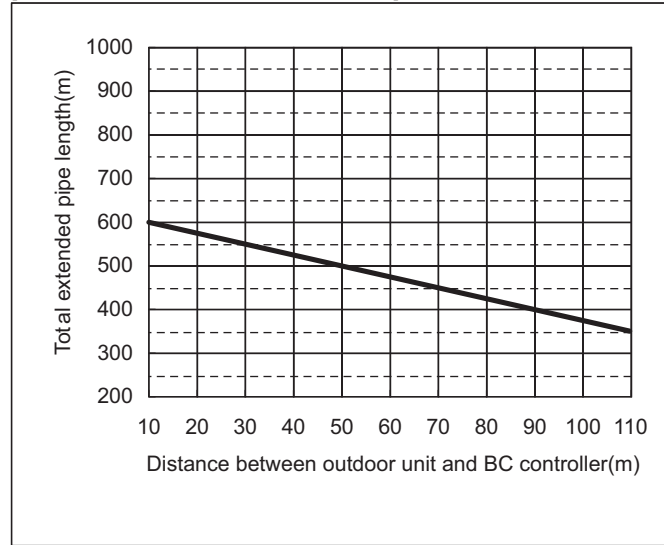

[PURY-P400, 450, 500, 550, 600YSNW-A]

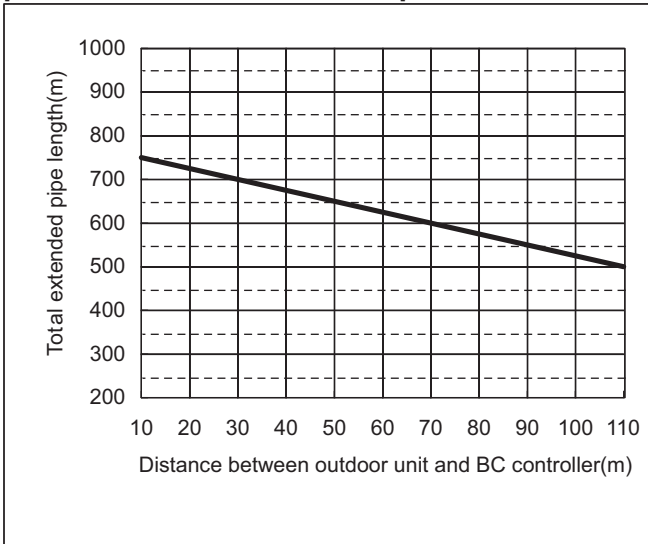

[PURY-P650YSNW-A]

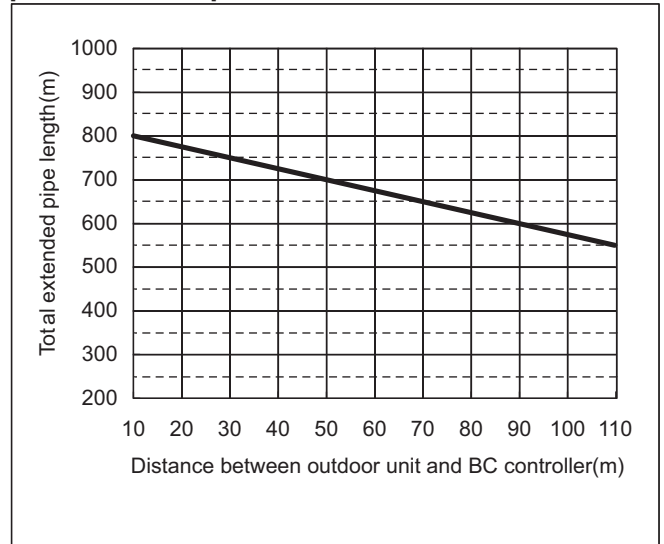

[PURY-P700, 750, 800, 850, 900, 950, 1000, 1050, 1100YSNW-A]

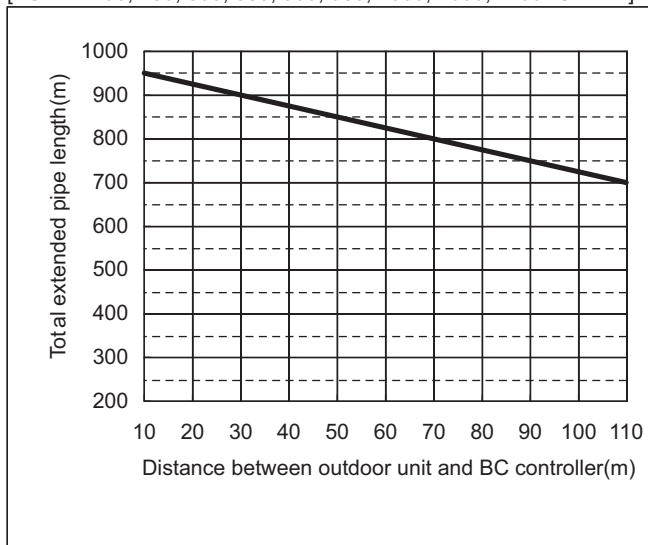

PURY-P-Y(S)NW-A

12-3. Refrigerant charging calculation

Sample connection (with 5 BC controllers and 8 indoor units) (PURY-P700YSNW-A)

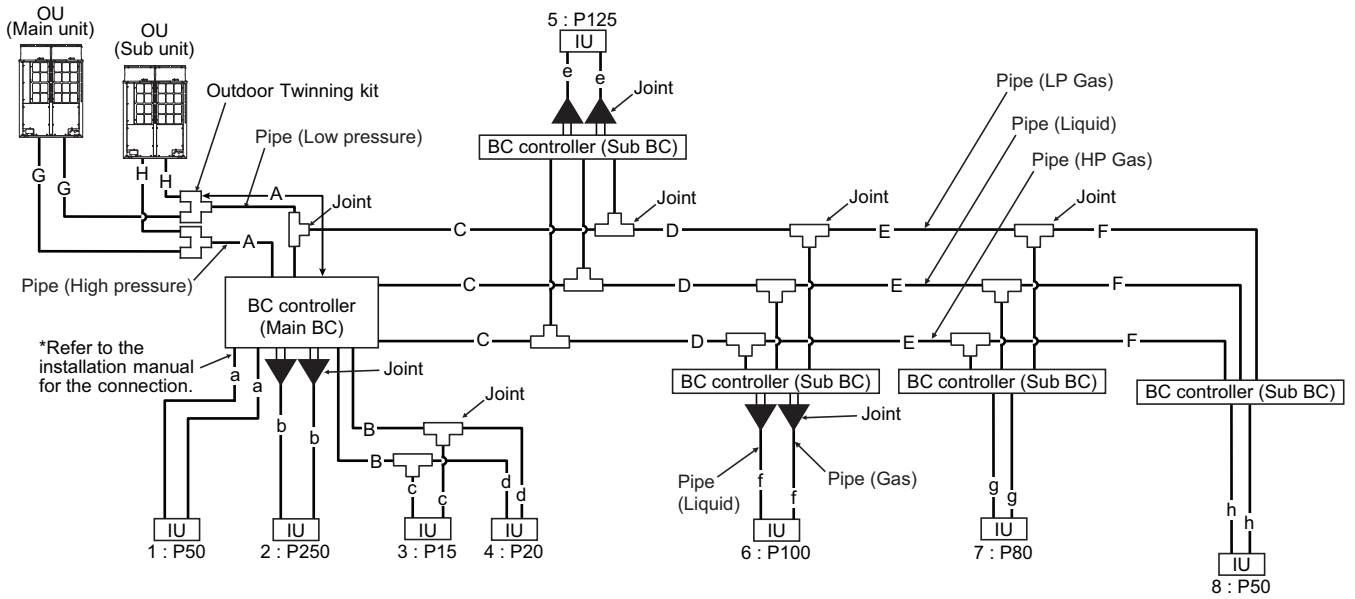

■ Amount of additional refrigerant to be charged

Refrigerant for extended pipes (field piping) is not factory-charged to the outdoor unit. Add an appropriate amount of refrigerant for each pipes on site. Record the size of each high pressure pipe and liquid pipe, and the amount of refrigerant that was charged on the outdoor unit for future reference.

■ Calculating the amount of additional refrigerant to be charged

The amount of refrigerant to be charged is calculated with the size of the on-site-installed high pressure pipes and liquid pipes, and their length. Calculate the amount of refrigerant to be charged according to the formula below.

Round up the calculation result to the nearest 0.1kg. (i.e., 16.03 kg = 16.1 kg)

- * When connecting PEFY-P50VMHS2-E units, add 2.81 kg of refrigerant per indoor unit.
- * When connecting PEFY-P63VMHS2-E units, add 3.27 kg of refrigerant per indoor unit.
- * When connecting PEFY-P71VMHS2-E units, add 2.50 kg of refrigerant per indoor unit.
- * When connecting PEFY-P80VMHS2-E units, add 2.50 kg of refrigerant per indoor unit.
- * When connecting PEFY-P100VMHS2-E units, add 2.50 kg of refrigerant per indoor unit.

<Amount of additional refrigerant to be charged>

■ Calculating the amount of additional refrigerant to be charged

Units "m" and "kg" (In an R2 system)

<Formula>

- When the piping length from the outdoor unit to the farthest indoor unit is 30.5 m (100 ft) or shorter

Amount of additional charge (kg)	=	High-pressure pipe ø34.93 total length × 0.58 (kg/m)	+	High-pressure pipe ø28.58 total length × 0.36 (kg/m)	+	High-pressure pipe ø22.2 total length × 0.23 (kg/m)	+	High-pressure pipe ø19.05 total length × 0.16 (kg/m)	+	High-pressure pipe ø15.88 total length × 0.11 (kg/m)
		Liquid pipe ø19.05 total length × 0.29 (kg/m)	+	Liquid pipe ø15.88 total length × 0.2 (kg/m)	+	Liquid pipe ø12.7 total length × 0.12 (kg/m)	+	Liquid pipe ø9.52 total length × 0.06 (kg/m)	+	Liquid pipe ø6.35 total length × 0.024 (kg/m)

Main or Sub BC controller	Amount (kg/unit)
J-type	1.5
JA-type	3.0
KA-type	4.7
KB-type	0.4

Total capacity of connected indoor units	Amount(kg) (to be added for indoor unit)
80 or below	2.0
81 to 160	2.5
161 to 330	3.0
331 to 390	3.5
391 to 480	4.5
481 to 630	5.0
631 to 710	6.0
711 to 800	8.0
801 to 890	9.0
891 to 1070	10.0
1071 to 1250	12.0
1251 or above	14.0

* When connecting the CMB-P**-V-G1, CMB-P**-V-GA1, CMB-P**-V-HA1, CMB-P**-V-GB1, or CMB-P**-V-HB1 to a given system, add the amount of refrigerant as indicated in the table below.

BC controller	Amount (kg/unit)	+	Total capacity of outdoor units	Amount (To be added for G1/GA1/HA1-type BC controller)
G1/GA1-type	0		P200	3.0 kg
HA1-type	2.0		P250	4.5 kg
GB1/HB1-type	1.0		P300	4.5 kg
			P350-P900	6.0 kg

• When the piping length from the outdoor unit to the farthest indoor unit is longer than 30.5 m (100 ft)

Amount of additional charge (kg)	=	High-pressure pipe ø34.93 total length × 0.52 (kg/m)	+	High-pressure pipe ø28.58 total length × 0.33 (kg/m)	+	High-pressure pipe ø22.2 total length × 0.21 (kg/m)	+	High-pressure pipe ø19.05 total length × 0.14 (kg/m)	+	High-pressure pipe ø15.88 total length × 0.1 (kg/m)
	+	Liquid pipe ø19.05 total length × 0.26 (kg/m)	+	Liquid pipe ø15.88 total length × 0.18 (kg/m)	+	Liquid pipe ø12.7 total length × 0.11 (kg/m)	+	Liquid pipe ø9.52 total length × 0.054 (kg/m)	+	Liquid pipe ø6.35 total length × 0.021 (kg/m)
+	Main or Sub BC controller	Amount (kg/unit)	Total capacity of connected indoor units		Amount(kg) (to be added for indoor unit)					
	J-type	1.5	80 or below	2.0						
	JA-type	3.0	81 to 160	2.5						
	KA-type	4.7	161 to 330	3.0						
	KB-type	0.4	331 to 390	3.5						
			391 to 480	4.5						
			481 to 630	5.0						
			631 to 710	6.0						
			711 to 800	8.0						
			801 to 890	9.0						
			891 to 1070	10.0						
			1071 to 1250	12.0						
		1251 or above	14.0							

* When connecting the CMB-P**-V-G1, CMB-P**-V-GA1, CMB-P**-V-HA1, CMB-P**-V-GB1, or CMB-P**-V-HB1 to a given system, add the amount of refrigerant as indicated in the table below.

BC controller	Amount (kg/unit)	+	Total capacity of outdoor units	Amount (To be added for G1/GA1/HA1-type BC controller)
			P200	3.0 kg
			P250	4.5 kg
			P300	4.5 kg
			P350-P900	6.0 kg

■ Amount of factory charged refrigerant

Outdoor unit Model	Charged amount
P200	5.2 kg
P250	
P300	
P350	8.0 kg
P400	
P450	10.8 kg
P500	
P550	

■ Sample calculation

Indoor 1: 50 A: ø28.58 40m a: ø6.35 10m
 2: 250 B: ø9.52 10m b: ø9.52 10m
 3: 15 C: ø12.7 20m c: ø6.35 5m
 4: 20 D: ø9.52 5m d: ø6.35 5m
 5: 125 E: ø9.52 5m e: ø9.52 5m
 6: 100 F: ø9.52 5m f: ø9.52 5m
 7: 80 G: ø19.05 3m g: ø9.52 5m
 8: 50 H: ø19.05 1m h: ø6.35 10m

Outdoor P700
 Main BC controller CMB-P108V-JA
 Sub BC controller CMB-P104V-KB × 4

The total length of each liquid line as follows:
 ø28.58: A = 40 m
 ø19.05: G + H = 4 m
 ø12.70: C = 20 m
 ø9.52: B + D + E + F + b + e + f + g = 50 m
 ø6.35: a + c + d + h = 30 m
 <Calculation example>
 Additional refrigerant charge
 = 40 × 0.33 + 4 × 0.14 + 20 × 0.11 + 50 × 0.054
 + 30 × 0.021 + 3 + 0.4 × 4 + 6
 = 28.7 (28.69)kg

■ Limitation of the amount of refrigerant to be charged

The above calculation result of the amount of refrigerant to be charged must become below the value in the table below.

Total index of the outdoor units	Factory charged	kg	P200 YNW	P250 YNW	P300 YNW	P350 YNW	P400 YNW	P450 YNW	P500 YNW	P550 YNW	P400 YSNW	P450 YSNW	P500 YSNW	P550 YSNW	P600 YSNW	P650 YSNW	
			5.2	5.2	5.2	8.0	8.0	10.8	10.8	10.8	10.4	10.4	10.4	10.4	10.4	10.4	13.2
			Charged on site	kg	31.8	37.8	37.8	41.3	47.3	44.5	45.2	45.2	60.6	60.6	60.6	60.6	60.6
Maximum refrigerant charge	Total for system	kg	37.0	43.0	43.0	49.3	55.3	55.3	56.0	56.0	71.0	71.0	71.0	71.0	71.0	78.8	

Total index of the outdoor units	Factory charged	kg	P700 YSNW	P750 YSNW	P800 YSNW	P850 YSNW	P900 YSNW	P950 YSNW	P1000 YSNW	P1050 YSNW	P1100 YSNW
			16.0	16.0	16.0	18.8	21.6	21.6	21.6	21.6	21.6
			Charged on site	kg	79.6	79.6	83.0	80.2	77.4	77.4	77.4
Maximum refrigerant charge	Total for system	kg	95.6	95.6	99.0	99.0	99.0	99.0	99.0	99.0	99.0

13-1. Requirement on installation site

1. No direct thermal radiation to the unit.
2. No possibility of annoying the neighbors by the sound of the unit.

Valves and refrigerant flow on the outdoor unit may generate noise.

3. Avoid the sites where strong winds blow.
4. With strength to bear the weight of the unit.
5. Drain flow from the unit is cared at heating mode.
6. Enough space for installation and service as shown at 13-2.
7. Avoid the sites where acidic solutions or chemical sprays (sulfuric compounds) are used frequently.
8. The unit should be secure from combustible gas, oil, steam, chemical gas like acidic solution, sulfur gas and so on.

13-2. Spacing

In case of single installation

(1) When all walls are within their height limits*.

[mm (in)]

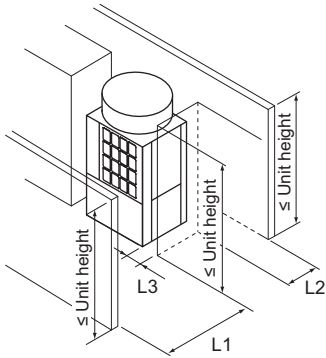

* Height limit

Front/Right/Left/Rear	Same height or lower than the overall height of the unit
-----------------------	--

	Required minimum distance [mm (in)]		
	L1 (Front)	L2 (Rear)	L3 (Right/Left)
When the distance behind the unit (L2) needs to be small	450 (17-3/4)	100 (3-15/16)	50 (2)
When the distance to the right or left (L3) needs to be small	450 (17-3/4)	300 (11-13/16)	15 (5/8)

(2) When one or more walls exceed their height limits*.

When the wall(s) at the front and/or the right/left exceed(s) their height limits

When the wall at the rear exceeds its height limit

When all walls exceed their height limits

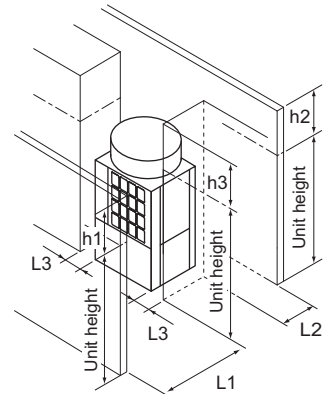
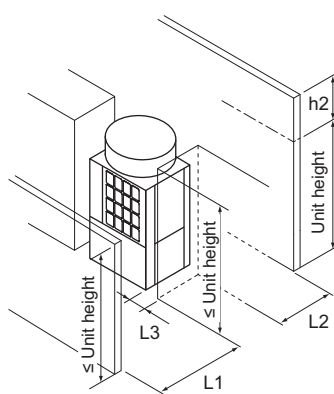
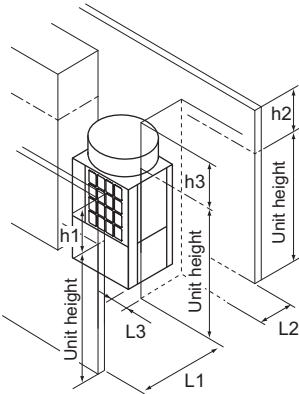

Add the dimension that exceeds the height limit (shown as "h1" through "h3" in the figures) to L1, L2, and L3 as shown in the table below.

	Required minimum distance [mm (in)]		
	L1 (Front)	L2 (Rear)	L3 (Right/Left)
When the distance behind the unit (L2) needs to be small	450 (17-3/4) + h1	100 (3-15/16) + h2	50 (2) + h3
When the distance to the right or left (L3) needs to be small	450 (17-3/4) + h1	300 (11-13/16) + h2	15 (5/8) + h3

(3) When there are overhead obstacles

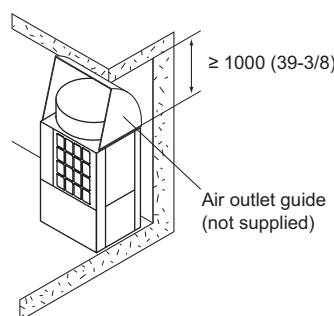
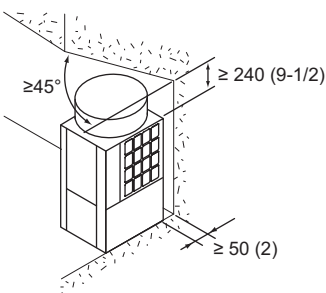

In case of collective installation and continuous installation

- When installing multiple units, make sure to take into consideration factors such as providing enough space for people to pass through, ample space between blocks of units, and sufficient space for airflow. (The areas marked with [A] in the figures below must be left open.)
- In the same way as with the single unit installation, add the dimension that exceeds the height limit (shown as "h1" through "h3" in the figures) to L1, L2, and L3 as shown in the tables below.
- If there are walls in the front and rear of the block of units, up to six units (three units for units P500 and P550) can be installed consecutively side by side, and a space of 1000 mm (39-3/8 in) or more must be left between each block of six units (three units for units P500 and P550).

(1) Side-by-side installation

When the distances between the units (L4) need to be small

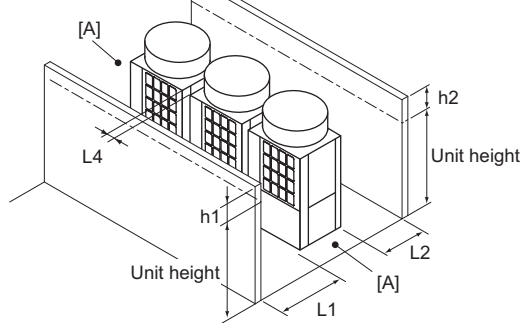

Required minimum distance [mm (in)]		
L1 (Front)	L2 (Rear)	L4 (Between)
450 (17-3/4) + h1	300 (11-13/16) + h2	30 (1-3/16)

When the distance behind the block of units (L2) needs to be small

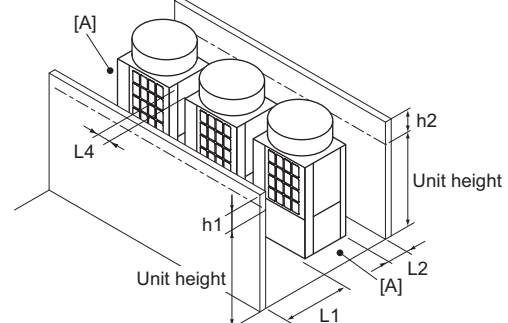

Required minimum distance [mm (in)]		
L1 (Front)	L2 (Rear)	L4 (Between)
450 (17-3/4) + h1	100 (3-15/16) + h2	100 (3-15/16)

(2) Face-to-face installation

When there are walls in the front and rear of the block of units

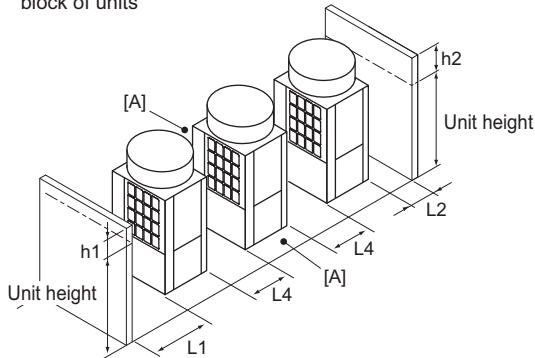

Required minimum distance [mm (in)]		
L1 (Front)	L2 (Rear)	L4 (Between)
450 (17-3/4) + h1	100 (3-15/16) + h2	450 (17-3/4)

When there is a wall on either the right or left side of the block of units

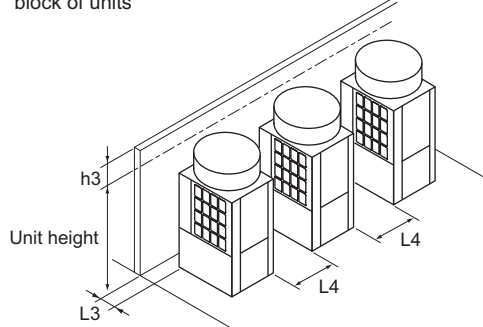

Required minimum distance [mm (in)]	
L3 (Right/Left)	L4 (Between)
15 (5/8) + h3	450 (17-3/4)

(3) Combination of face-to-face and side-by-side installations

When there are walls in the front and rear of the block of units

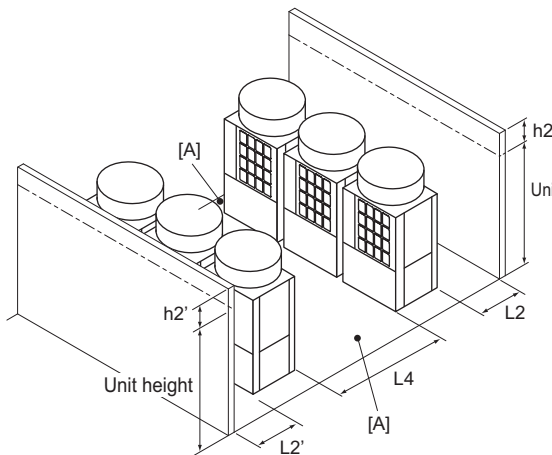

Required minimum distance [mm (in)]		
L2 (Rear)	L2' (Rear)	L4 (Between)
300 (11-13/16) + h2	300 (11-13/16) + h2'	900 (35-7/16)

[A]: Leave open in two directions.

When there are two walls in an L-shape

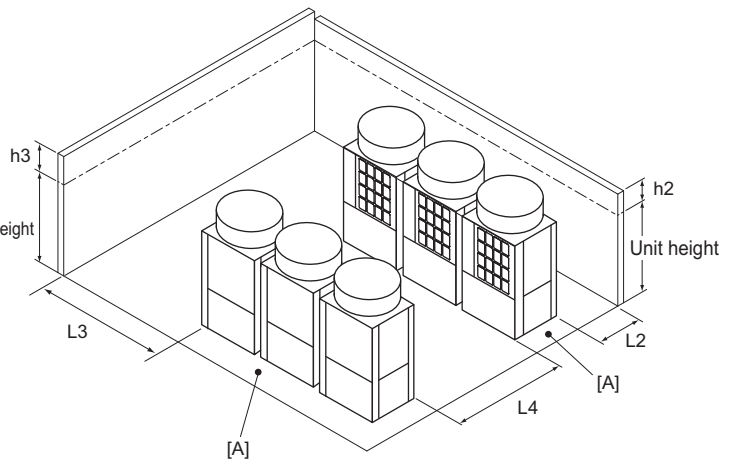

Required minimum distance [mm (in)]		
L2 (Rear)	L3 (Right/Left)	L4 (Between)
300 (11-13/16) + h2	1000 (39-3/8) + h3	900 (35-7/16)

13-3. Piping direction

13-3-1. Lifting method

- Always use two slings to lift up the unit. Each sling must be at least 8 m (26 ft) long and must be able to support the weight of the unit.
- Put protective pads between slings and the unit where the slings touch the unit at the base to protect the unit from being scratched.
- Put 50 mm (2 in) or thicker protective pads between slings and the unit where the slings touch the unit at the top of the unit to protect the unit from being scratched and to avoid contact with the slings and the fan guard.
- Make sure that the angles between slings at the top are less than 40 degrees

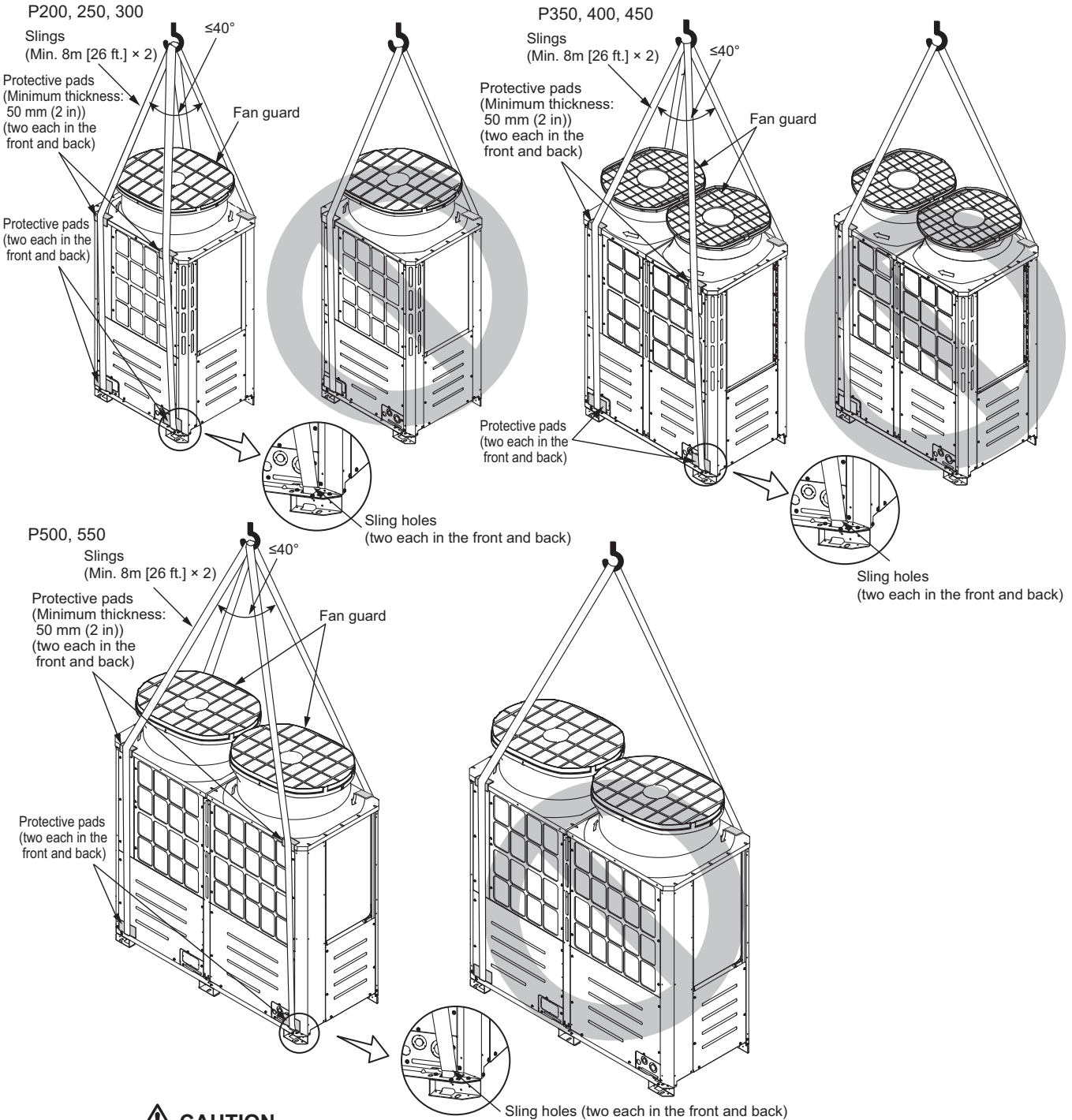

PURY-P-Y(S)NW-A

CAUTION

Exercise caution when transporting products.

- Products weighing more than 20 kg [45 LBS] should not be carried alone.
- Do not carry the product by the PPbands.
- To avoid the risk of injury, do not touch the heat exchanger fins.
- Plastic bags may pose a risk of choking hazard to children. Tear plastic bags into pieces before disposing of them.
- When lifting and transporting outdoor units with ropes, run the ropes through lifting hole at the unit base. Securely fix the unit so that the ropes will not slide off, and always lift the unit at four points to prevent the unit from falling.

13-3-2. Installation

- Secure the unit with anchor bolts as shown in the figure below so that the unit will not topple over with strong wind or during an earthquake.
- Install the unit on a durable base made of such materials as concrete or angle steel.
- Take appropriate anti-vibration measures (e.g., vibration damper pad, vibration isolation base) to keep vibrations and noise from being transmitted from the unit through walls and floors.
- When using a rubber cushion, install it so that the cushion covers the entire width of the unit leg.
- Install the unit in such a way that the corner of the angle bracket at the base of the unit shown in the figure below is securely supported.
- Install the anchor bolt in such a way that the top end of the anchor bolt do not stick out more than 30 mm [1-3/16 in.].
- This unit is not designed to be anchored with post-installation-type anchor bolts, although by adding fixing brackets anchoring with such type of anchor bolts becomes possible.

- (A) M10 anchor bolt (not supplied)
- (B) (Incorrect installation) The corner section is not securely received.
- (C) Fixing bracket for post-installed anchor bolts (not supplied) (To be fixed with three screws)
- (D) Anti-vibration rubber pad (The pad needs to be large enough to cover the entire width of each unit leg.)
- (E) Detachable leg

⚠ WARNING
 Properly install the unit on a surface that can withstand the weight of the unit. Unit installed on an unstable surface may fall and cause injury.

⚠ WARNING
 Take appropriate safety measures against strong winds and earthquakes to prevent the unit from falling.

<Without detachable leg>

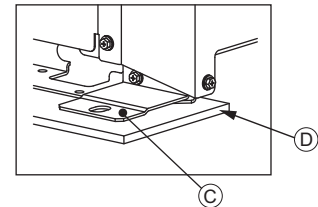
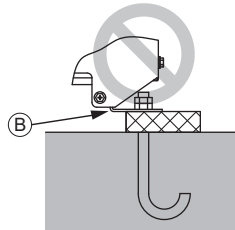
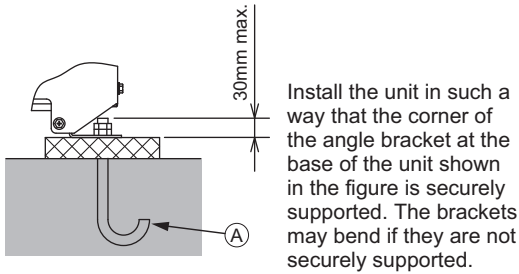

<With detachable leg>

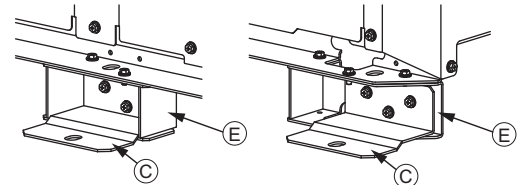
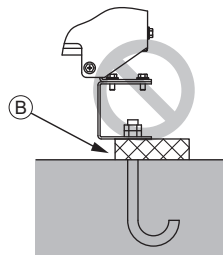
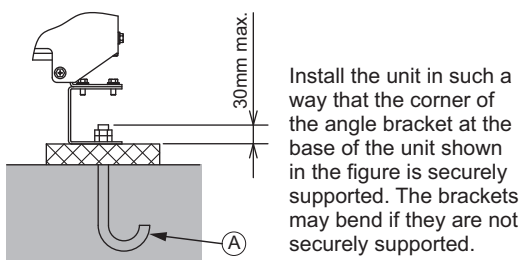

Take into consideration the durability of the base, water drainage route (Drain water is discharged from outdoor units during operation.), piping route, and wiring route when performing foundation work.

13-3-3. Anchor bolt positions

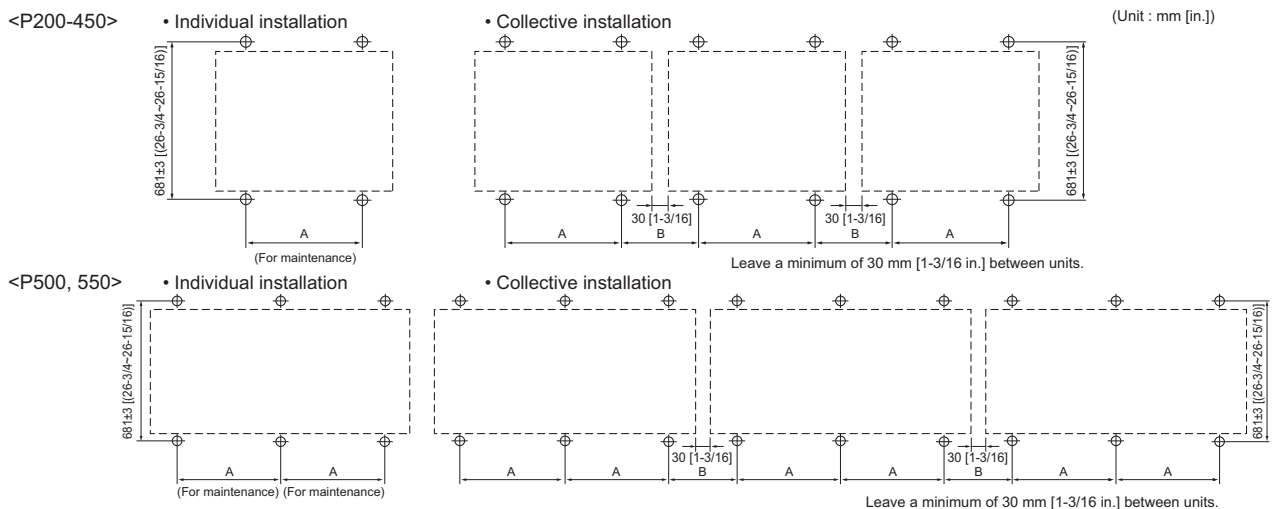

	P200, 250, 300	P350, 400, 450	P500, 550
A	760±2 [29-15/16(29-7/8-30)]	1060±2 [41-3/4(41-11/16-41-13/16)]	795±2 [31-5/16(31-1/4-31-7/16)]
B	190 [7-1/2]	210 [8-5/16]	190 [7-1/2]

PURV-P-Y(S)NW-A

13-3-4. Installation

When the pipes and/or cables are routed at the bottom of the unit, make sure that the through hole at the base of the unit does not get blocked with the installation base.
 When the pipes are routed at the bottom of the unit, the base should be at least 100 mm [3-15/16 in.] in height.

(Unit: mm[in.])

P200, 250, 300

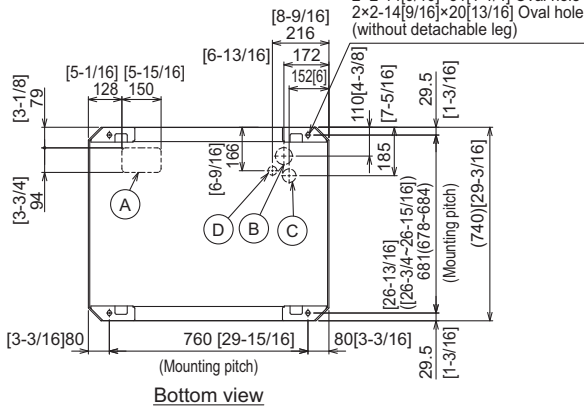

P350, 400, 450

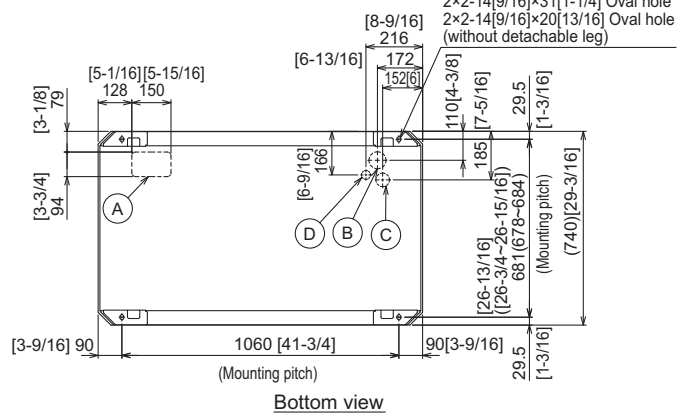

P500, 550

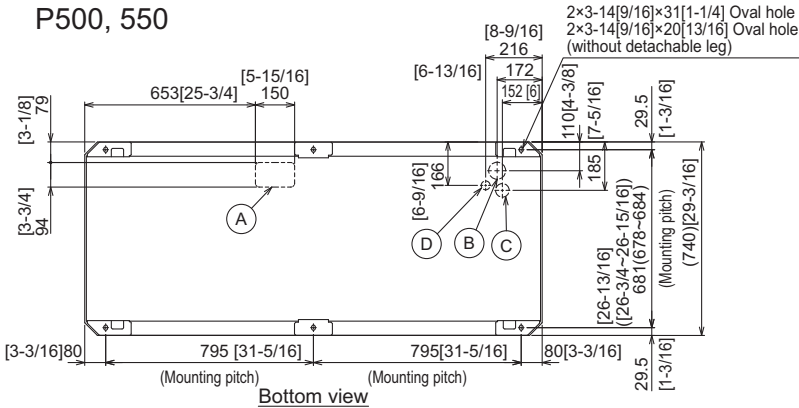

NO.	Usage	Specifications
(A)	For pipes	Bottom through hole 150 x 94 Knockout hole [5-15/16] [3-3/4]
(B)	For wires	Bottom through hole ø65 Knockout hole [2-9/16]
(C)		Bottom through hole ø52 Knockout hole [2-1/16]
(D)	For transmission cables	Bottom through hole ø34 Knockout hole [1-3/8]

Installation base parallel to the unit's front panel

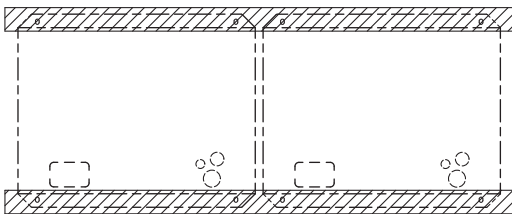

Installation base perpendicular to the unit's front panel

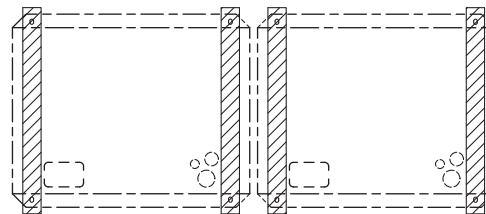

13-3-5. Refrigerant pipe routing

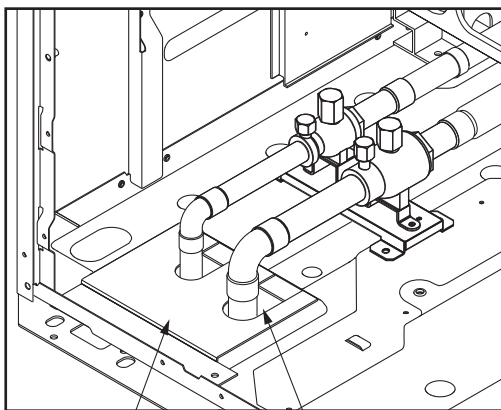

Example of closure materials (field supply) Fill the gap at the site

The gaps around the edges of through holes for pipes and wires on the unit allow water or mice to enter the unit and damage its parts. Close these gaps with filler plates.

This unit allows two types of pipe routing:

- Bottom piping
- Front piping

CAUTION

To prevent small animals, water and snow from entering the unit and damage its parts, close the gap around the edges of through holes for pipes and wires with filler plates.

13-3-6. Twinning on the outdoor unit side

- The pipe from multiple outdoor units must be installed so that oil will not accumulate in the pipe under certain conditions. Refer to the figures below for details.

* Small dots in the figures indicate branching points.

Ⓐ To a BC controller

- The pipe from the outdoor units must be inclined downward to the indoor unit side. In the figure on the right, because the pipe is inclined upward, the oil in the pipe accumulates when Unit 1 is in operation and Unit 2 is stopped.



- The distance between the unit bottom and the pipe (H) must be 0.2 m (7-7/8 in) or below. In the figure on the right, because the distance is more than 0.2 m (7-7/8 in), the oil accumulates in Unit 1 when Unit 2 is in operation and Unit 1 is stopped.



- The vertical separation between units (H) must be 0.1 m (3-15/16 in) or below. In the figure on the right, because the distance is more than 0.1 m (3-15/16 in), the oil accumulates in Unit 1 when Unit 2 is in operation and Unit 1 is stopped.



- The vertical separation between units (H) must be 0.1 m (3-15/16 in) or below. In the figure on the right, because the distance is more than 0.1 m (3-15/16 in), the oil accumulates in Unit 2 when Unit 1 is in operation and Unit 2 is stopped.

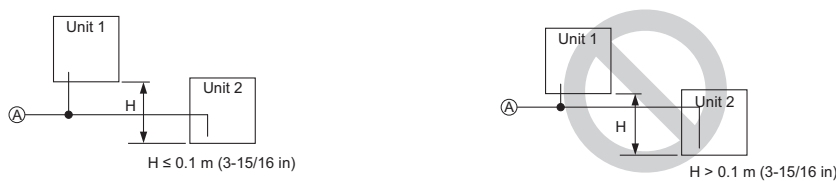

- Make sure that the inclination tolerance of the Twinning Kit is $\pm 15^\circ$ to the ground to avoid unit damage.

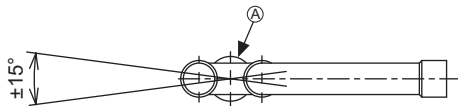

Ⓐ Twinning Kit

- If the length of the pipe between the branching point and the outdoor unit exceeds 2 m (6 ft), provide a trap within 2 m (6 ft) from the branching point. The trap must be at least 200 mm (7-7/8 in) in height. (gas pipe only) If there is no trap, oil can accumulate inside the pipe, causing a shortage of oil and may damage the compressor.

* Small dots in the figures indicate branching points.

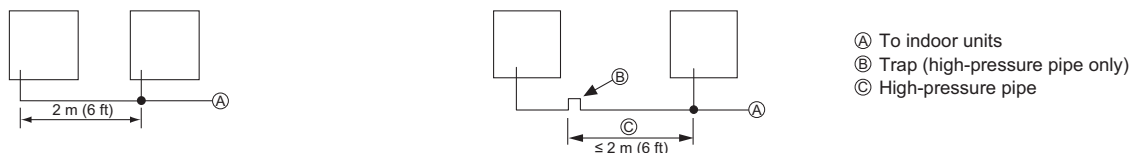

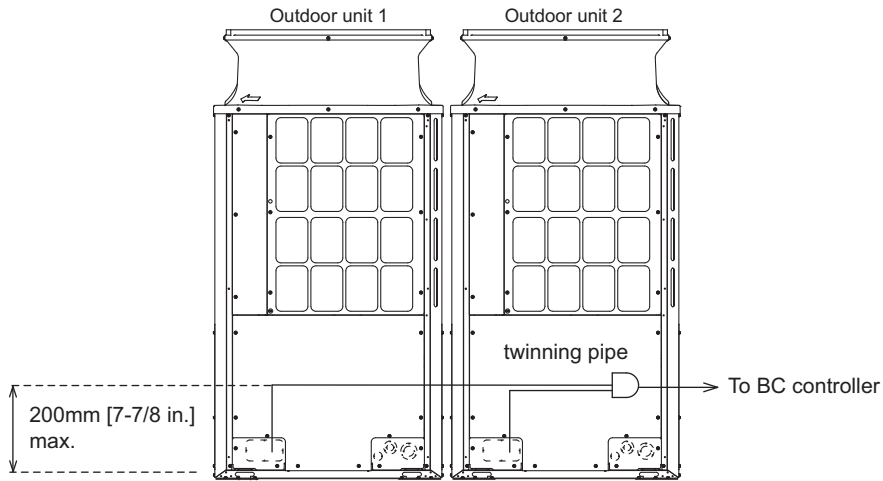

13-3-7. Twinning on the outdoor unit side

See the following drawing for connecting the pipes between the outdoor units.

<In case of 2units combination>

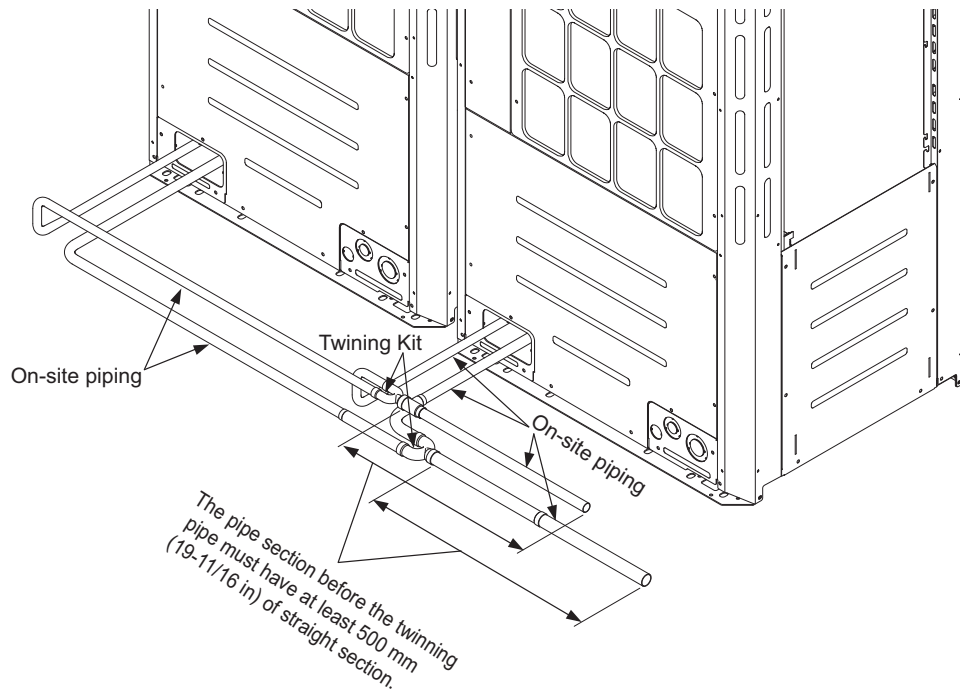

- ♦ PURY-P200YNW-A through PURY-P500YNW-A, and PURY-EP200YNW-A through PURY-EP500YNW-A can be used in a Hybrid City Multi system. Contact your dealer when connecting the larger capacity units in a Hybrid City Multi system.

PURY-P-Y(S)NW-A

13-4. Countermeasure to wind

Referring to the figure shown below, take appropriate measures which will suit the actual situation of the place for installation. A unit installed alone is vulnerable to strong winds. Select the installation site carefully to minimize the effect of winds. To install a unit in a place where the wind always blows from the same direction, install the unit so that the outlet faces away from the direction of the wind.

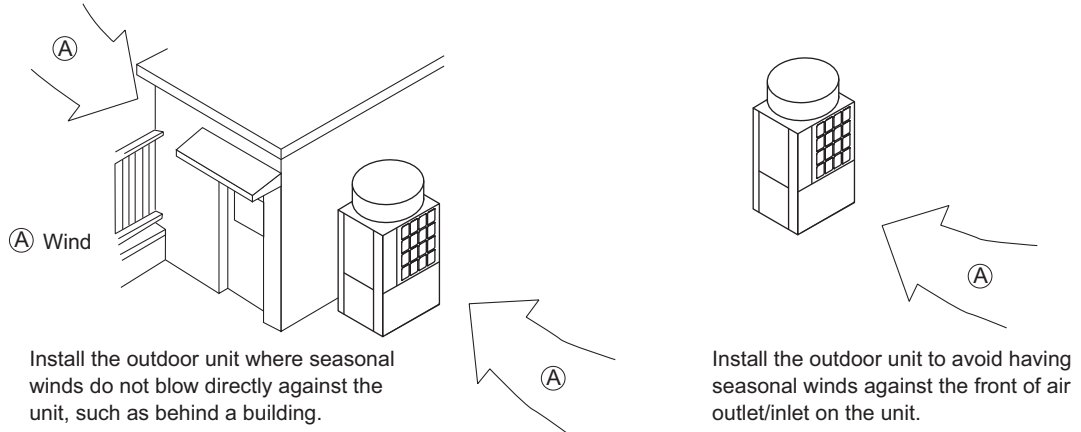

13-5. Precautions for installing a panel heater

If there is a risk that the drain water will freeze inside the outdoor unit, the installation of a panel heater is recommended. When installing a panel heater, provide sufficient space for maintenance accordingly. For details, refer to the installation manual for the panel heater.

INSTALLATION INFORMATION

1. Installation information	2
1-1. General precautions.....	2
1-2. Precautions for Indoor unit and BC controller	3
1-3. Precautions for Fresh air intake type indoor unit	4
1-4. Precautions for Outdoor unit/Heat source unit.....	4
1-5. Precautions for Control-related items	5

1. Installation information

* Refer to the enclosed Installation Manual for details on installation. Arrange to have an expert install the system correctly.

1-1. General precautions

1-1-1. Usage

- ♦The air-conditioning system described in this Data Book is designed for human comfort.
- ♦This product is not designed for preservation of food, animals, plants, precision equipment, or art objects. To prevent quality loss, do not use the product for purposes other than what it is designed for.
- ♦To reduce the risk of water leakage and electric shock, do not use the product for air-conditioning vehicles or vessels.

1-1-2. Installation environment

- ♦Do not install any unit other than the dedicated unit in a place where the voltage changes a lot, large amounts of mineral oil (e.g., cutting oil) are present, cooking oil may splash, or a large quantity of steam can be generated such as a kitchen.
- ♦Do not install the unit in acidic or alkaline environment.
- ♦Installation should not be performed in the locations exposed to chlorine or other corrosive gases. Avoid near a sewer.
- ♦To reduce the risk of fire, do not install the unit in a place where flammable gas may be leaked or inflammable material is present.
- ♦This air conditioning unit has a built-in microcomputer. Take the noise effects into consideration when deciding the installation position. Especially in a place where antenna or electronic device are installed, it is recommended that the air conditioning unit be installed away from them.
- ♦Install the unit on a solid foundation according to the local safety measures against typhoons, wind gusts, and earthquakes to prevent the unit from being damaged, toppling over, and falling.

1-1-3. Backup system

- ♦In a place where air conditioner's malfunctions may exert crucial influence, it is recommended to have two or more systems of single outdoor/heat source units with multiple indoor units.

1-1-4. Unit characteristics

- ♦Heat pump efficiency of outdoor unit depends on outdoor temperature. In the heating mode, performance drops as the outside air temperature drops. In cold climates, performance can be poor. Warm air would continue to be trapped near the ceiling and the floor level would continue to stay cold. In this case, heat pumps require a supplemental heating system or air circulator. Before purchasing them, consult your local distributor for selecting the unit and system.
- ♦When the outdoor temperature is low and the humidity is high, the heat exchanger on the outdoor unit side tends to collect frost, which reduces its heating performance. To remove the frost, Auto-defrost function will be activated and the heating mode will temporarily stop for 3-10 minutes. Heating mode will automatically resume upon completion of defrost process.
- ♦Air conditioner with a heat pump requires time to warm up the whole room after the heating operation begins, because the system circulates warm air in order to warm up the whole room.
- ♦The sound levels were obtained in an anechoic room. The sound levels during actual operation are usually higher than the simulated values due to ambient noise and echoes. Refer to the section on "SOUND LEVELS" for the measurement location.
- ♦Depending on the operation conditions, the unit generates noise caused by valve actuation, refrigerant flow, and pressure changes even when operating normally. Please consider to avoid location where quietness is required. For BC/HBC controller, it is recommended to unit to be installed in places such as ceilings of corridor, restrooms and plant rooms.
- ♦The total capacity of the connected indoor units can be greater than the capacity of the outdoor/heat source unit. However, when the connected indoor units operate simultaneously, each unit's capacity may become smaller than the rated capacity.
- ♦When the unit is started up for the first time within 12 hours after power on or after power failure, it performs initial startup operation (capacity control operation) to prevent damage to the compressor. The initial startup operation requires 90 minutes maximum to complete, depending on the operation load.

1-1-5. Relevant equipment

- ♦Use an earth leakage breaker (ELB) with medium sensitivity, and an activation speed of 0.1 second or less.
- ♦Consult your local distributor or a qualified technician when installing an earth leakage breaker.
- ♦If the unit is inverter type, select an earth leakage breaker for handling high harmonic waves and surges.
- ♦Leakage current is generated not only through the air conditioning unit but also through the power wires. Therefore, the leakage current of the main power supply is greater than the total leakage current of each unit. Take into consideration the capacity of the earth leakage breaker or leakage alarm when installing one at the main power supply. To measure the leakage current simply on site, use a measurement tool equipped with a filter, and clamp all the four power wires together. The leakage current measured on the ground wire may not accurate because the leakage current from other systems may be included to the measurement value.
- ♦Do not install a phase advancing capacitor on the unit connected to the same power system with an inverter type unit and its equipment.
- ♦If a large current flows due to the product malfunctions or faulty wiring, both the earth leakage breaker on the product side and the upstream overcurrent breaker may trip almost at the same time. Separate the power system or coordinate all the breakers depending on the system's priority level.

1. Installation information

1-1-6. Unit installation

- ♦Your local distributor or a qualified technician must read the Installation Manual that is provided with each unit carefully before performing installation work.
- ♦Consult your local distributor or a qualified technician when installing the unit. Improper installation by an unqualified person may result in water leakage, electric shock, or fire.
- ♦Ensure there is enough space around each unit.

1-1-7. Optional accessories

- ♦Only use accessories recommended by Mitsubishi Electric. Consult your local distributor or a qualified technician when installing them. Improper installation by an unqualified person may result in water leakage, electric leakage, system breakdown, or fire.
- ♦Some optional accessories may not be compatible with the air conditioning unit to be used or may not be suitable for the installation conditions. Check the compatibility when considering any accessories.
- ♦Note that some optional accessories may affect the air conditioner's external form, appearance, weight, operating sound, and other characteristics.

1-1-8. Operation/Maintenance

- ♦Read the Instruction Book that is provided with each unit carefully prior to use.
- ♦Maintenance or cleaning of each unit may be risky and require expertise. Read the Instruction Book to ensure safety. Consult your local distributor or a qualified technician when special expertise is required such as when the indoor unit needs to be cleaned.

1-2. Precautions for Indoor unit and BC controller

1-2-1. Operating environment

- ♦The refrigerant (R410A) used for air conditioner is non-toxic and nonflammable. However, if the refrigerant leaks, the oxygen level may drop to harmful levels. If the air conditioner is installed in a small room, measures must be taken to prevent the refrigerant concentration from exceeding the safety limit even if the refrigerant should leak.
- ♦If the units operate in the cooling mode at the humidity above 80%, condensation may collect and drip from the indoor units.

1-2-2. Unit characteristics

- ♦The return air temperature display on the remote controller may differ from the ones on the other thermometers.
- ♦The clock on the remote controller may be displayed with a time lag of approximately one minute every month.
- ♦The temperature using a built-in temperature sensor on the remote controller may differ from the actual room temperature due to the effect of the wall temperature.
- ♦Use a built-in thermostat on the remote controller or a separately-sold thermostat when indoor units installed on or in the ceiling operate the automatic cooling/heating switchover.
- ♦The room temperature may rise drastically due to Thermo OFF in the places where the air conditioning load is large such as computer rooms.
- ♦Be sure to use a regular filter. If an irregular filter is installed, the unit may not operate properly, and the operation noise may increase.
- ♦The room temperature may rise over the preset temperature in the environment where the heating air conditioning load is small.

1-2-3. Unit installation

- ♦The insulation for low pressure pipe between the BC controller and outdoor/heat source unit shall be at least 20 mm thick. If the unit is installed on the top floor or in a high-temperature, high-humidity environment, thicker insulation may be necessary.
- ♦Do not have any branching points on the downstream of the refrigerant pipe header.
- ♦When a field-supplied external thermistor is installed or when a device for the demand control is used, abnormal stop of the unit or damage of the electromagnetic contactor may occur. Consult your local distributor for details.
- ♦When indoor units operate a fresh air intake, install a filter in the duct (field-supplied) to remove the dust from the air.
- ♦The 4-way or 2-way Airflow Ceiling Cassette Type units that have an outside air inlet can be connected to the duct, but need a booster fan to be installed at site. Refer to the chapter "Indoor Unit" for the available range for fresh air intake volume.
- ♦Operating fresh air intake on the indoor unit may increase the sound pressure level.

1. Installation information

1-3. Precautions for Fresh air intake type indoor unit

1-3-1. Usage

- This unit mainly handles the outside air load, and is not designed to maintain the room temperature. Install other air conditioners for handling the air conditioning load in the room.

1-3-2. Unit characteristics

- This unit cannot perform the drying operation. The unit will continue the fan operation and blow fresh air (air that is not air-conditioned) when the Heating Thermo-OFF or Cooling Thermo-OFF mode is selected.
- The fan may stop tentatively when the unit is connected to the simultaneous cooling/heating operation type outdoor/heat source unit (R2/WR2-Series) or during the defrost cycle.
- This unit switches the Thermo ON or OFF depending on the room temperature. The outside air is directly supplied into the room during Thermo OFF. Take caution of the cold supply air due to low outside air temperature and of condensation in the room due to high humidity of the outside air.
- Outside air temperature ranges for the operation must be as follows:
Cooling: 21°C D.B./15.5°C W.B. ~ 43°C D.B./35°C W.B.
Heating: -10°C D.B. ~ 20°C D.B.
The unit is forced to operate Thermo OFF (fan operation) when the outside air temperature is as follows.
Cooling: 21°C D.B. or below; Heating: 20°C D.B. or above
- Either a remote controller (sold separately) or a remote sensor (sold separately) must be installed to monitor the room temperature.
- If only this unit is used as an indoor unit, condensation may form at the supply air grill while the unit is operated in the cooling mode. This unit cannot operate dehumidifying.
- Use the unit in the way that the airflow rate will not exceed the 110% of the rated airflow.

1-4. Precautions for Outdoor unit/Heat source unit

1-4-1. Installation environment

- Outdoor unit with salt-resistant specification is recommended to use in a place where it is subject to salt air.
- Even when the unit with salt-resistant specification is used, it is not completely protected against corrosion. Be sure to follow the directions or precautions described in Instructions Book and Installation Manual for installation and maintenance. The salt-resistant specification is referred to the guidelines published by JRAIA (JRA9002).
- Install the unit in a place where the flow of discharge air is not obstructed. If not, the short-cycling of discharge air may occur.
- Provide proper drainage around the unit base, because the condensation may collect and drip from the outdoor units. Provide water-proof protection to the floor when installing the units on the rooftop.
- In a region where snowfall is expected, install the unit so that the outlet faces away from the direction of the wind, and install a snow guard to protect the unit from snow. Install the unit on a base approximately 50 cm higher than the expected snowfall. Close the openings for pipes and wiring, because the ingress of water and small animals may cause equipment damage. If SUS snow guard is used, refer to the Installation Manual that comes with the snow guard and take caution for the installation to avoid the risk of corrosion.
- When the unit is expected to operate continuously for a long period of time at outside air temperatures of below 0°C, take appropriate measures, such as the use of a unit base heater, to prevent icing on the unit base. (Not applicable to the PUMY-Series)
- Install the snow guard so that the outlet/inlet faces away from the direction of the wind.
- When the snow accumulates approximately 50 cm or more on the snow guard, remove the snow from the guard. Install a roof that is strong enough to withstand snow loads in a place where snow accumulates.
- Provide proper protection around the outdoor units in places such as schools to avoid the risk of injury.
- A cooling tower and heat source water circuit should be a closed circuit that water is not exposed to the atmosphere. When a tank is installed to ensure that the circuit has enough water, minimize the contact with outside air so that the oxygen from being dissolved in the water should be 1 mg/L or less.
- Install a strainer (50 mesh or more recommended) on the water pipe inlet on the heat source unit.
- Interlock the heat source unit and water circuit pump.
- Note the followings to prevent the freeze bursting of pipe when the heat source unit is installed in a place where the ambient temperature can be 0°C or below.
 - Keep the water circulating to prevent it from freezing when the ambient temperature is 0°C or below.
 - Before a long period of non use, be sure to purge the water out of the unit.
- Salt-resistant unit is resistant to salt corrosion, but not salt-proof.
Please note the following when installing and maintaining outdoor units in marine atmosphere.
 1. Install the salt-resistant unit out of direct exposure to sea breeze, and minimize the exposure to salt water mist.
 2. Avoid installing a sun shade over the outdoor unit, so that rain will wash away salt deposits off the unit.
 3. Install the unit horizontally to ensure proper water drainage from the base of the unit. Accumulation of water in the base of the outdoor unit will significantly accelerate corrosion.
 4. Periodically wash salt deposits off the unit, especially when the unit is installed in a coastal area.
 5. Repair all noticeable scratches after installation and during maintenance.
 6. Periodically check the unit, and apply anti-rust agent and replace corroded parts as necessary.

1. Installation information

1-4-2. Circulating water

- ♦ Follow the guidelines published by JRAIA (JRA-GL02-1994) to check the water quality of the water in the heat source unit regularly.
- ♦ A cooling tower and heat source water circuit should be a closed circuit that water is not exposed to the atmosphere. When a tank is installed to ensure that the circuit has enough water, minimize the contact with outside air so that the oxygen from being dissolved in the water should be 1 mg/L or less.

1-4-3. Unit characteristics

- ♦ When the Thermo ON and OFF is frequently repeated on the indoor unit, the operation status of outdoor/heat source units may become unstable.

1-4-4. Relevant equipment

- ♦ Provide grounding in accordance with the local regulations.

1-5. Precautions for Control-related items

1-5-1. Product specification

- ♦ To introduce the MELANS system, a consultation with us is required in advance. Especially to introduce the electricity charge apportioning function or energy-save function, further detailed consultation is required. Consult your local distributor for details.
- ♦ Billing calculation for AE-200E/AE-50E/EW-50E/AG-150A/EB-50GU-J/TG-2000A, or the billing calculation unit is unique and based on our original method. (Backup operation is included.) It is not based on the metering method, and do not use it for official business purposes. It is not the method that the amount of electric power consumption (input) by air conditioner is calculated. Note that the electric power consumption by air conditioner is apportioned by using the ratio corresponding to the operation status (output) for each air conditioner (indoor unit) in this method.
- ♦ In the apportioned billing function for AE-200E/AE-50E/EW-50E/AG-150A and EB-50GU-J, use separate watt-hour meters for A-control units, K-control units, and packaged air conditioner for City Multi air conditioners. It is recommended to use an individual watt-hour meter for the large-capacity indoor unit (with two or more addresses).
- ♦ When using the peak cut function on the AE-200E/AE-50E/EW-50E/AG-150A or EB-50GU-J, note that the control is performed once every minute and it takes time to obtain the effect of the control. Take appropriate measures such as lowering the criterion value. Power consumption may exceed the limits if AE-200E/AE-50E/EW-50E/AG-150A or EB-50GU-J malfunctions or stops. Provide a back-up remedy as necessary.
- ♦ The controllers cannot operate while the indoor unit is OFF. (No error)
Turn ON the power to the indoor unit when operating the controllers.
- ♦ When using the interlocked control function on the AE-200E/AE-50E/EW-50E/AG-150A/EB-50GU-J/PAC-YG66DCA or PAC-YG63MCA, do not use it for the control for the fire prevention or security. (This function should never be used in the way that would put people's lives at risk.) Provide any methods or circuit that allow ON/OFF operation using an external switch in case of failure.

1-5-2. Installation environment

- ♦ The surge protection for the transmission line may be required in areas where lightning strikes frequently occur.
- ♦ A receiver for a wireless remote controller may not work properly due to the effect of general lighting. Leave a space of at least 1 m between the general lighting and receiver.
- ♦ When the Auto-elevating panel is used and the operation is made by using a wired remote controller, install the wired remote controller to the place where all air conditioners controlled (at least the bottom part of them) can be seen from the wired remote controller. If not, the descending panel may cause damage or injury, and be sure to use a wireless remote controller designed for use with elevating panel (sold separately).
- ♦ Install the wired remote controller (switch box) to the place where the following conditions are met.
 - ♦ Where installation surface is flat
 - ♦ Where the remote controller can detect an accurate room temperature
The temperature sensors that detect a room temperature are installed both on the remote controller and indoor unit. When a room temperature is detected using the sensor on the remote controller, the main remote controller is used to detect a room temperature. In this case, follow the instructions below.
 - ♦ Install the controller in a place where it is not subject to the heat source.
(If the remote controller faces direct sunlight or supply air flow direction, the remote controller cannot detect an accurate room temperature.)
 - ♦ Install the controller in a place where an average room temperature can be detected.
 - ♦ Install the controller in a place where no other wires are present around the temperature sensor.
(If other wires are present, the remote controller cannot detect an accurate room temperature.)
- ♦ To prevent unauthorized access, always use a security device such as a VPN router when connecting AE-200E/AE-50E/EW-50E/AG-150A/EB-50GU-J or TG-2000A to the Internet.

CAUTION FOR REFRIGERANT LEAKAGE

1. Caution for refrigerant leakage	b-3-2
1-1. Refrigerant property	b-3-2
1-2. Confirm the Critical concentration and take countermeasure	b-3-2

1. Caution for refrigerant leakage

The installer and/or air conditioning system specialist shall secure safety against refrigerant leakage according to local regulations or standards. The following standard may be applicable if no local regulation or standard is available.

1-1. Refrigerant property

R410A refrigerant is harmless and incombustible. The R410A is heavier than the indoor air in density. Leakage of the refrigerant in a room has possibility to lead to a hypoxia situation. Therefore, the critical concentration specified below shall not be exceeded even if the leakage happens.

• Critical concentration

Critical concentration hereby is the refrigerant concentration in which no human body would be hurt if immediate measures can be taken when refrigerant leakage happens.

Critical concentration of R410A: 0.44kg/m³
(The weight of refrigeration gas per 1 m³ air conditioning space.);

* The Critical concentration is subject to ISO5149, EN378-1.

For the CITY MULTI system, the concentration of refrigerant leaked should not have a chance to exceed the critical concentration in any situation.

1-2. Confirm the Critical concentration and take countermeasure

The maximum refrigerant leakage concentration (Rmax) is defined as the result of the possible maximum refrigerant weight (Wmax) leaked into a room divided by its room capacity (V). It is referable to Fig.1-1. The refrigerant of Outdoor/Heat source unit here includes its original charge and additional charge at the site.

The additional charge is calculated according to the refrigerant charging calculation of each kind of Outdoor/Heat source unit, and shall not be over charged at the site. Procedure 1-2-1~3 tells how to confirm maximum refrigerant leakage concentration (Rmax) and how to take countermeasures against a possible leakage.

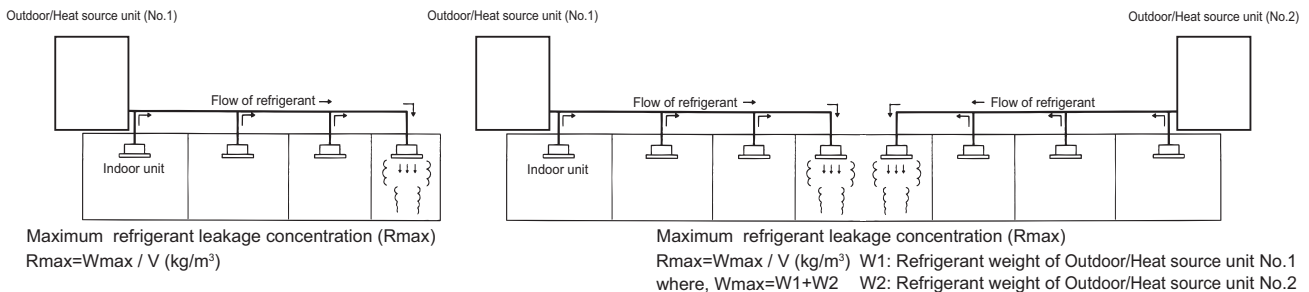

Fig. 1-1 The maximum refrigerant leakage concentration

1-2-1. Find the room capacity (V),

If a room having total opening area more than 0.15% of the floor area at a low position with another room/space, the two rooms/space are considered as one. The total space shall be added up.

1-2-2. Find the possible maximum leakage (Wmax) in the room. If a room has Indoor unit(s) from more than 1 Outdoor/Heat source unit, add up the refrigerant of the Outdoor/Heat source units.

1-2-3. Divide (Wmax) by (V) to get the maximum refrigerant leakage concentration (Rmax).

1-2-4. Find if there is any room in which the maximum refrigerant leakage concentration (Rmax) is over 0.44kg/m³.

If no, then the CITY MULTI is safe against refrigerant leakage.

If yes, following countermeasure is recommended to do at site.

Countermeasure 1: Let-out (making V bigger)

Design an opening of more than 0.15% of the floor area at a low position of the wall to let out the refrigerant whenever leaked. e.g. make the upper and lower seams of door big enough.

Countermeasure 2: Smaller total charge (making Wmax smaller)

e.g. Avoid connecting more than 1 Outdoor/Heat source unit to one room.
 e.g. Using smaller model size but more Outdoor/Heat source units.
 e.g. Shorten the refrigerant piping as much as possible.

Countermeasure 3: Fresh air in from the ceiling (Ventilation)

As the density of the refrigerant is bigger than that of the air. Fresh air supply from the ceiling is better than air exhausting from the ceiling. Fresh air supply solution refers to Fig. 1-2~4.

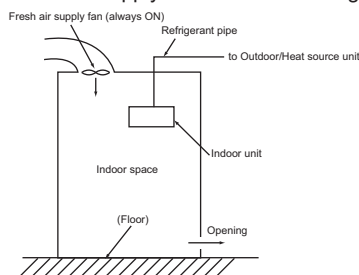

Fig. 1-2. Fresh air supply always ON

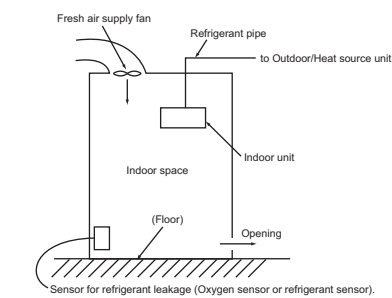

Fig. 1-3. Fresh air supply upon sensor action

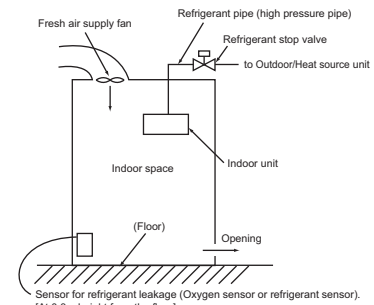

Fig. 1-4. Fresh air supply and refrigerant shut-off upon sensor action

Note 1. Countermeasure 3 should be done in a proper way in which the fresh air supply shall be on whenever the leakage happens.

Note 2. In principle, MITSUBISHI ELECTRIC requires proper piping design, installation and air-tight testing after installation to avoid leakage happening.

In the area should earthquake happen, anti-vibration measures should be fully considered.

The piping should consider the extension due to the temperature variation.



for a greener tomorrow

Eco Changes is the Mitsubishi Electric Group's environmental statement, and expresses the Group's stance on environmental management. Through a wide range of businesses, we are helping contribute to the realization of a sustainable society.

⚠ Warning

- Do not use refrigerant other than the type indicated in the manuals provided with the unit and on the nameplate.
 - Doing so may cause the unit or pipes to burst, or result in explosion or fire during use, repair, or at the time of disposal of the unit.
 - It may also be in violation of applicable laws.
 - MITSUBISHI ELECTRIC CORPORATION cannot be held responsible for malfunctions or accidents resulting from the use of the wrong type of refrigerant.
- Our air conditioning equipment and heat pumps contain a fluorinated greenhouse gas, R410A.

MITSUBISHI ELECTRIC CORPORATION

www.MitsubishiElectric.com