

Operation manual

Daikin room air conditioner



**CTXA15A2V1BW
FTXA20A2V1BW
FTXA25A2V1BW
FTXA35A2V1BW
FTXA42A2V1BW
FTXA50A2V1BW**

**CTXA15(A)(B)2V1BS
FTXA20(A)(B)2V1BS
FTXA25(A)(B)2V1BS
FTXA35(A)(B)2V1BS
FTXA42(A)(B)2V1BS
FTXA50(A)(B)2V1BS**

**CTXA15(A)(B)2V1BT
FTXA20(A)(B)2V1BT
FTXA25(A)(B)2V1BT
FTXA35(A)(B)2V1BT
FTXA42(A)(B)2V1BT
FTXA50(A)(B)2V1BT**

**CTXA15B2V1BB
FTXA20B2V1BB
FTXA25B2V1BB
FTXA35B2V1BB
FTXA42B2V1BB
FTXA50B2V1BB**

Table of Contents

1	About the documentation	2
1.1	About this document.....	2
2	About the system	2
2.1	Indoor unit	3
2.2	About the user interface	3
2.2.1	Components: User interface	3
2.2.2	To operate the user interface.....	4
3	Before operation	4
3.1	To fix the user interface to the wall.....	4
3.2	To insert the batteries.....	4
3.3	About the clock.....	4
3.3.1	To set the clock.....	4
3.4	Brightness of the indoor unit display	4
3.4.1	To set the brightness of the indoor unit display	4
3.5	To turn on the power supply.....	5
3.6	To change indoor unit position setting.....	5
4	Operation	5
4.1	Operation range	5
4.2	Operation mode and temperature setpoint.....	5
4.2.1	To start/stop operation mode and to set the temperature.....	6
4.3	Airflow rate	6
4.3.1	To adjust the airflow rate.....	6
4.4	Airflow direction	6
4.4.1	To adjust vertical airflow direction	6
4.4.2	To adjust horizontal airflow direction.....	6
4.4.3	To use 3-D airflow direction	7
4.5	Comfort airflow and Intelligent eye operation	7
4.5.1	Comfort airflow operation.....	7
4.5.2	Intelligent eye operation.....	7
4.5.3	To start/stop Comfort and Intelligent eye operation	7
4.6	Powerful operation	8
4.6.1	To start/stop Powerful operation	8
4.7	Econo and Outdoor unit quiet operation.....	8
4.7.1	Econo operation.....	8
4.7.2	Outdoor unit quiet operation	8
4.7.3	To start/stop Econo and Outdoor unit quiet operation	8
4.8	Flash Streamer (air cleaning) operation	8
4.8.1	To start/stop Flash Streamer (air cleaning) operation.....	8
4.9	OFF/ON timer operation.....	8
4.9.1	To start/stop OFF timer operation.....	9
4.9.2	To start/stop ON timer operation.....	9
4.9.3	To combine OFF timer and ON timer.....	9
4.10	Weekly timer operation.....	9
4.10.1	To set Weekly timer operation	10
4.10.2	To copy reservations.....	10
4.10.3	To confirm reservations	10
4.10.4	To deactivate and reactivate Weekly timer operation	11
4.10.5	To delete reservations	11
4.11	Wireless LAN connection	11
4.11.1	Precautions when using the wireless adapter.....	11
4.11.2	To install the Daikin Online Controller application	11
4.11.3	To set the wireless connection.....	11
5	Energy saving and optimum operation	13
6	Maintenance and service	13
6.1	Overview: Maintenance and service	13
6.2	To clean the indoor unit and user interface	14
6.3	To clean the front panel.....	14
6.4	To open the front panel	14
6.5	About the air filters	14
6.6	To clean the air filters	14

6.7	To clean the titanium apatite deodorizing filter and the silver particle filter (Ag-ion filter)	15
6.8	To replace the titanium apatite deodorizing filter and the silver particle filter (Ag-ion filter)	15
6.9	To close the front panel.....	15
6.10	To remove the front panel	15
6.11	To take following items into account before a long idle period...	16

7 Troubleshooting 16

7.1	Troubleshooting for wireless connection adapter	16
-----	---	----

8 Disposal 17

1 About the documentation

1.1 About this document

Thank you for purchasing this product. Please:

- Keep the documentation for future reference.

Target audience

End users



INFORMATION

This appliance is intended to be used by expert or trained users in shops, in light industry, and on farms, or for commercial and household use by lay persons.

Documentation set

This document is part of a documentation set. The complete set consists of:

- **General safety precautions:**
 - Safety instructions that you must read before operating your system
 - Format: Paper (in the box of the indoor unit)
- **Operation manual:**
 - Quick guide for basic usage
 - Format: Paper (in the box of the indoor unit)
- **User reference guide:**
 - Detailed step-by-step instructions and background information for basic and advanced usage
 - Format: Digital files on <http://www.daikineurope.com/support-and-manuals/product-information/>

Latest revisions of the supplied documentation may be available on the regional Daikin website or via your installer.

The original documentation is written in English. All other languages are translations.

2 About the system



WARNING: FLAMMABLE MATERIAL

The refrigerant inside this unit is mildly flammable.



CAUTION

The indoor unit contains radio equipment, minimum separation distance between the radiating part of the equipment and the user is 10 cm.



NOTICE

Do NOT use the system for other purposes. In order to avoid any quality deterioration, do NOT use the unit for cooling precision instruments, food, plants, animals, or works of art.

2.1 Indoor unit



CAUTION

Do NOT insert fingers, rods or other objects into the air inlet or outlet. When the fan is rotating at high speed, it will cause injury.



INFORMATION

The sound pressure level is less than 70 dBA.



WARNING

- Do not modify, disassemble, remove, reinstall or repair the unit yourself as incorrect dismantling or installation may cause an electric shock or fire. Contact your dealer.
- In case of accidental refrigerant leaks, make sure there are no naked flames. The refrigerant itself is entirely safe, non-toxic and mildly flammable, but it will generate toxic gas when it accidentally leaks into a room where combustible air from fan heaters, gas cookers, etc. is present. Always have qualified service personnel confirm that the point of leakage has been repaired or corrected before resuming operation.

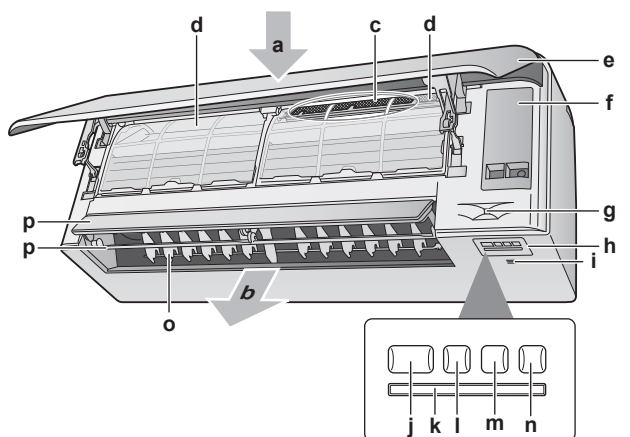

- a Air inlet
- b Air outlet
- c Titanium apatite deodorizing filter and silver particle filter (Ag-ion filter)
- d Air filter
- e Front panel
- f Service cover
- g Intelligent eye sensor
- h Display
- i Room temperature and humidity sensor
- j ON/OFF button and operation lamp (green)
- k Signal receiver
- l Timer lamp (orange)
- m Intelligent eye lamp (green)
- n Wireless adapter ON/OFF button
- o Louvers (vertical blades)
- p Flaps (horizontal blades)

Note: Position of titanium apatite deodorizing filter and silver particle filter is interchangeable.

ON/OFF button

If the user interface is missing, you can use the ON/OFF button on the indoor unit to start/stop operation. When operation is started using this button, the following settings are used:

- Operation mode = Automatic

- Temperature setting = 25°C
- Airflow rate = Automatic

2.2 About the user interface

- Direct sunlight.** Do NOT expose the user interface to direct sunlight.
- Dust.** Dust on the signal transmitter or receiver will reduce sensitivity. Wipe off dust with a soft cloth.
- Fluorescent lights.** Signal communication might be disabled if fluorescent lamps are in the room. In that case, contact your installer.
- Other appliances.** If the user interface signals operate other appliances, move the other appliances, or contact your installer.
- Curtains.** Make sure that the signal between the unit and the user interface is NOT blocked by curtains or other objects.



NOTICE

- Do NOT drop the user interface.
- Do NOT let the user interface get wet.

2.2.1 Components: User interface

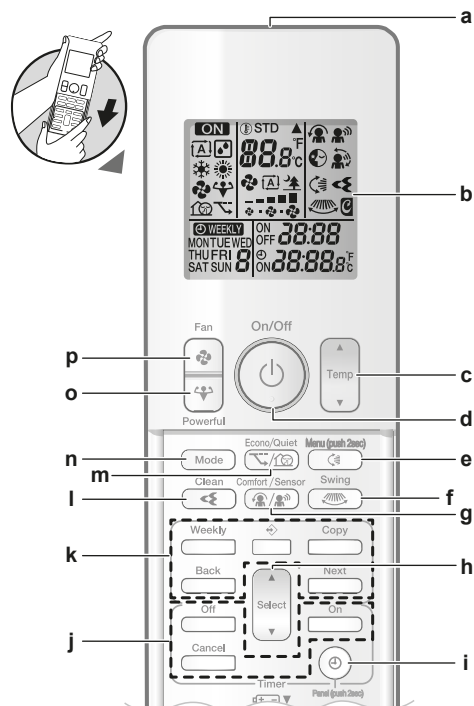

- a Signal transmitter
- b LCD display
- c Temperature adjustment button
- d ON/OFF button
- e Vertical swing and menu (push 2 seconds) button
- f Horizontal swing button
- g Comfort airflow and Intelligent eye operation button
- h Select button
- i Clock and open panel (push 2 seconds) button
- j OFF/ON timer operation buttons
- k Weekly timer operation buttons
- l Flash Streamer (air cleaning) operation button
- m Econo and Outdoor unit quiet operation button
- n Mode button
- o Powerful button
- p Fan button



INFORMATION

Use  (hold for 2 seconds) to open the front panel when you clean the air filters. See "6.4 To open the front panel" [p. 14].

3 Before operation

2.2.2 To operate the user interface

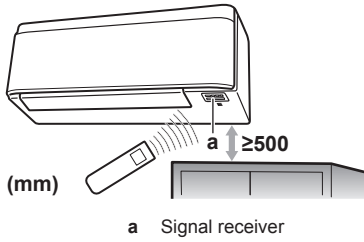

Note: Make sure that there are no obstacles within 500 mm under the signal receiver. They may influence reception performance of the user interface.

- 1 Aim the signal transmitter at the signal receiver on the indoor unit (maximum distance for communication is 7 m).

Result: When the indoor unit receives a signal from the user interface, you will hear a sound:

Sound	Description
Beep-beep	Operation starts.
Beep	Setting changes.
Long beep	Operation stops.

3 Before operation

3.1 To fix the user interface to the wall

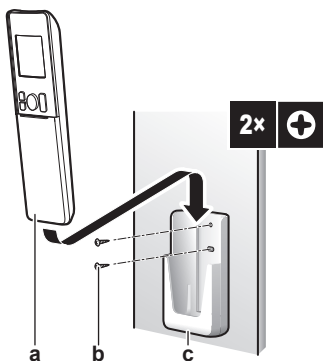

- a User interface
b Screws (field supply)
c User interface holder

- 1 Choose a place where the signals reach the unit.
- 2 Attach the holder with screws to the wall or a similar location.
- 3 Hang the user interface on the user interface holder.

3.2 To insert the batteries

The batteries will last for about 1 year.

- 1 Remove the front cover.
- 2 Insert both batteries at once.
- 3 Put back the front cover.

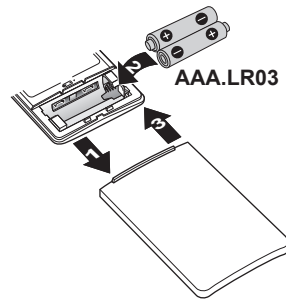

i INFORMATION

- Low energy of battery is indicated by flashing of LCD display.
- ALWAYS replace both batteries at once.

3.3 About the clock

If the indoor unit's internal clock is NOT set to the correct time, the ON timer, OFF timer and weekly timer will NOT operate correctly. The clock must be set again:

- After a circuit breaker has turned the unit OFF.
- After a power failure.
- After replacing batteries in the user interface.

3.3.1 To set the clock

Note: If the time is NOT set, MON, ☉, and 0:00 blink.

- 1 Press ☉.

Result: MON and ☉ blink

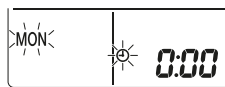

- 2 Press or to set the current day of the week.

Note: Holding down or increases or decreases the time setting rapidly.

- 3 Press ☉.

Result: ☉ blinks.

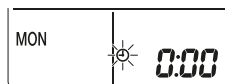

- 4 Press or to set the correct time.

- 5 Press ☉.

Result: Setting is complete. . blinks.

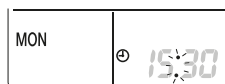

3.4 Brightness of the indoor unit display

Adjust the brightness of the indoor unit display as desired, or turn OFF the display.

3.4.1 To set the brightness of the indoor unit display

- 1 Press for at least 2 seconds.

Result: The menu appears on the display. is blinking.

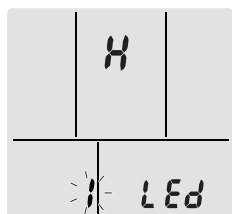

2 Press

3 Press or to change the setting as follows:



...is blinking	Brightness is...
H	High
L	Low
of	Off

4 To confirm the selected setting, press

Result: The brightness setting is changed.

Note: The display automatically returns to the default screen after 60 seconds. To return to the default screen sooner, press twice.

3.5 To turn on the power supply

1 Turn the circuit breaker on.

Result: The flap of the indoor unit will open and close to set the reference position.

3.6 To change indoor unit position setting

Set the indoor unit position to avoid direct airflow to walls.

1 Press for at least 2 seconds.

Result: The menu *!* appears on the display.

2 Press or to change the menu to *3*.

Result: The menu *3* appears on the display. *3* blinks.

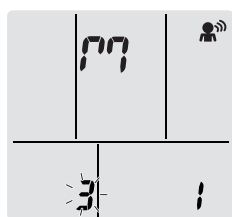

3 Press to select the menu.

Result: *!* blinks.

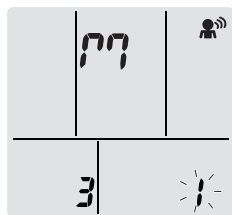

4 Press or to change the setting as follows:



If the unit is...	Symbol	Blinks	Result
In the middle of the wall (factory default setting)	<i>!!</i>	<i>!</i>	
≤500 mm from the wall on right	<i>!9</i>	<i>2</i>	
≤500 mm from the wall on left	<i>P7</i>	<i>3</i>	

Result: The airflow range will be adjusted to avoid direct contact with the wall.

4 Operation

4.1 Operation range

Use the system in the following temperature and humidity ranges for safe and effective operation.

Operation mode	Operation range
Cooling ^{(a)(b)}	<ul style="list-style-type: none"> Outdoor temperature: -10~46°C DB Indoor temperature: 18~32°C DB Indoor humidity: ≤80%
Heating ^(a)	<ul style="list-style-type: none"> Outdoor temperature: -15~24°C DB Indoor temperature: 10~30°C DB
Drying ^(a)	<ul style="list-style-type: none"> Outdoor temperature: -10~46°C DB Indoor temperature: 18~32°C DB Indoor humidity: ≤80%

^(a) A safety device might stop the operation of the system if the unit runs outside its operation range.

^(b) Condensation and water dripping might occur if the unit runs outside its operation range.

4.2 Operation mode and temperature setpoint

When. Adjust the system operation mode and set the temperature when you want to:

- Heat up or cool down a room
- Blow air in a room without heating or cooling
- Decrease the humidity in a room

What. The system operates differently, depending on the user selection.

Setting	Description
Automatic	The system cools down or heats up a room to the temperature setpoint. It automatically switches between cooling and heating if necessary.
Drying	The system decreases the humidity in a room without changing the temperature.
Heating	The system heats up a room to the temperature setpoint.
Cooling	The system cools down a room to the temperature setpoint.

4 Operation

Setting	Description
Fan	The system only controls the airflow (airflow rate and airflow direction). The system does NOT control the temperature.

Additional info:

- **Outside temperature.** The system's cooling or heating effect decreases when the outside temperature is too high or too low.
- **Defrost operation.** During heating operation, frost might occur on the outdoor unit and decrease the heating capacity. In that case, the system automatically switches to defrosting operation to remove the frost. During defrosting operation, hot air is NOT blown from the indoor unit.
- **Humidity sensor.** Control the humidity by decreasing the humidity during cooling process.

4.2.1 To start/stop operation mode and to set the temperature



ON: Unit is operating.

: Operation mode = Automatic

: Operation mode = Drying

: Operation mode = Cooling

: Operation mode = Heating

: Operation mode = Fan only

88.8c: Shows the set temperature.

- 1 Press one or more times to select the operation mode.

Result: The mode will be set as follows:



- 2 Press to **start** operation.

Result: **ON** and the selected mode are displayed on the LCD.

- 3 Press or one or more times to lower or raise the temperature.

Cooling operation	Heating operation	Automatic operation	Drying or Fan only operation
18~32°C	10~30°C	18~30°C	—

Note: When using **drying** or **fan only** mode, you cannot adjust the temperature.

- 4 Press to **stop** operation.

Result: **ON** disappears from the LCD. The operation lamp goes off.

4.3 Airflow rate

- 1 Press to choose:

	5 airflow rate levels, from "==" to "=="
	Automatic operation
	Indoor unit quiet operation. When the airflow is set to "==" , the noise from the unit will be reduced.

INFORMATION

- If the unit reach the temperature setpoint in cooling, heating or automatic mode. Fan will stop operating.
- When using drying operation mode, you CANNOT adjust the airflow rate setting.

4.3.1 To adjust the airflow rate

- 1 Press to change the airflow setting as follows:



4.4 Airflow direction

When. Adjust the airflow direction as desired.

What. The system directs the airflow differently, depending on the user selection (swinging or fixed position). It does so by moving horizontal blades (flaps) or vertical blades (louvers).

Setting	Airflow direction
Vertical automatic swing	Moves up and down.
Horizontal automatic swing	Moves from side to side.
3-D airflow direction	Moves alternately up and down and from side to side
[—]	Stays in a fixed position.

CAUTION

ALWAYS use a user interface to adjust the position of the flaps and louvers. When the flaps and louvers are swinging and you move them forcibly by hand, the mechanism will break.

The movable range of the flap varies according to the operation mode. The flap will stop at the upper position when the airflow rate is changed to low during the up and down swing setting.

4.4.1 To adjust vertical airflow direction

- 1 Press .

Result: appears on the LCD. The flaps (horizontal blades) will begin to swing.

- 2 To use fixed position, press when the flaps reach the desired position.

Result: disappears from the LCD. The flaps will stop moving.

4.4.2 To adjust horizontal airflow direction

- 1 Press .

Result: appears on the LCD. The louvers (vertical blades) will begin to swing.

- 2 To use fixed position, press when the louvers reach the desired position.

Result: disappears from the LCD. The louvers will stop moving.

INFORMATION

When the unit is installed in a corner of a room, the direction of the louvers should be facing away from the wall. Efficiency will drop if a wall blocks the air.

4.4.3 To use 3-D airflow direction

- 1 Press and .

Result: and appear on the LCD. The flaps (horizontal blades) and louvers (vertical blades) will begin to swing.

- 2 To use fixed position, press and when the flaps and louvers reach the desired position.

Result: and disappear from the LCD. The flaps and the louvers will stop moving.

4.5 Comfort airflow and Intelligent eye operation

You can use Comfort and Intelligent eye operation separately, or combine them.

4.5.1 Comfort airflow operation

The unit will automatically change the direction of the airflow to heat up or cool down the room more effectively. Direct airflow from the unit will be less noticeable.

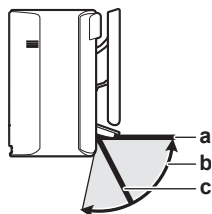

- a Flap position in cooling and dry operation
- b Flap range in heating operation (vertical airflow ON)
- c Flap position in heating operation (vertical airflow OFF)

In cooling and drying

The airflow direction will change to spread the air along the ceiling.

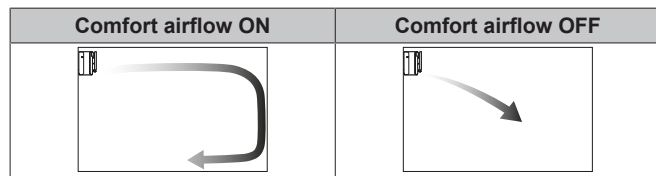

In heating

The airflow direction will change to spread the air along the floor. The unit detects the room and floor temperature and automatically selects 1 of the 3 airflow directions.

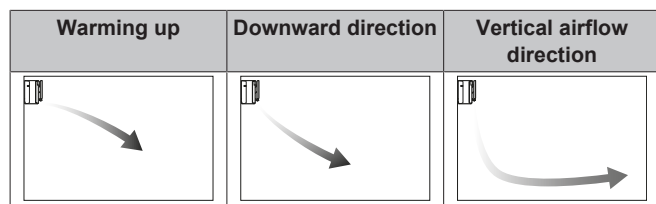

INFORMATION

If you want to deactivate the Vertical airflow function (e.g. in case there is furniture or another object under the unit), refer to "To turn ON/OFF vertical airflow function" [p. 7]. If the Vertical airflow function is deactivated, the airflow will be set to downward direction.



INFORMATION

Powerful and Comfort airflow operation CANNOT be used at the same time. The last selected function takes priority. If the vertical automatic swing is selected, Comfort airflow operation will be cancelled.

To turn ON/OFF vertical airflow function

- 1 Press for at least 2 seconds.

Result: The menu appears on the display.

- 2 Press or to change the menu screen.

Result: The menu appears on the display.

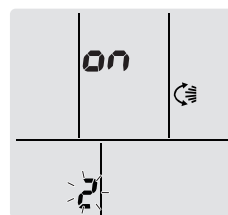

- 3 Press to change the setting.

- 4 Press or to change the setting.

...is blinking	Vertical airflow function is...
	turned ON
	turned OFF

- 5 To confirm the selected setting press .

Note: The display automatically returns to the default screen after 60 seconds. To return to the default screen sooner, press twice.

4.5.2 Intelligent eye operation

The system detects movement in the room and automatically adjusts the airflow direction and temperature in order to avoid direct contact with people. If no movement is detected for 20 minutes, the system switches to energy saving operation:

About the Intelligent eye sensor



NOTICE

- Do NOT hit or push the Intelligent eye sensor. Doing so may lead to malfunction.
- Do NOT place large objects near the Intelligent eye sensor.



INFORMATION

Powerful or Night set operation CANNOT be used at the same time with Intelligent eye operation. The last selected function takes priority.

- **Detection range.** Up to 9 m.
- **Detection sensitivity.** Changes according to location, the number of persons in the room, temperature range, etc.
- **Detection mistakes.** The sensor may mistakenly detect pets, sunlight, moving curtains, etc.

4.5.3 To start/stop Comfort and Intelligent eye operation

- 1 Press one or more times.

Result: The setting will change as follows:



Display	Operation
	Comfort airflow
	Intelligent eye
	Comfort airflow and Intelligent eye

4 Operation

Display	Operation
—	Both deactivated

Note: If there are people close to the front of the indoor unit or there are too many people, use both operations at the same time.

- To stop operation, press  until both symbols disappear from the LCD.

4.6 Powerful operation

This operation quickly maximizes the cooling/heating effect in any operation mode. You can get the maximum capacity.

INFORMATION

Powerful operation CANNOT be used together with Econo, Comfort airflow, Intelligent eye and Outdoor unit quiet operation. The last selected function takes priority.

Powerful operation will NOT increase the capacity of the unit if it already operates at maximum capacity.



4.6.1 To start/stop Powerful operation

- Press  to start.

Result:  is displayed on the LCD. Powerful operation runs for 20 minutes; after that, operation returns to the previously set mode.

- Press  to stop.

Result:  disappears from the LCD.

Note: Powerful operation can be set only when the unit is running. If you press , operation will be cancelled;  disappears from the LCD.

4.7 Econo and Outdoor unit quiet operation

4.7.1 Econo operation

This is a function which enables efficient operation by limiting the maximum power consumption value. This function is useful for cases in which attention should be paid to ensure a circuit breaker will not trip when the product runs alongside other appliances.

INFORMATION

- Powerful and Econo operation CANNOT be used at the same time. The last selected function takes priority.
- Econo operation reduces power consumption of the outdoor unit by limiting the rotation speed of the compressor. If power consumption is already low, Econo operation will NOT further reduce power consumption.

4.7.2 Outdoor unit quiet operation

Use Outdoor unit quiet operation when you want to decrease the noise level of the outdoor unit. **Example:** At night.

INFORMATION



- Powerful and Outdoor unit quiet operation CANNOT be used at the same time. The last selected function takes priority.
- This function is only available in Automatic, Cooling, and Heating operation.
- Outdoor unit quiet operation limits the rotation speed of the compressor. If the rotation speed of compressor is already low, Outdoor unit quiet operation will NOT further reduce the compressor rotation speed.

4.7.3 To start/stop Econo and Outdoor unit quiet operation



- Press  one or more times.

Result: The setting will change as follows.



Display	Operation
	Econo
	Outdoor unit quiet
	Econo and Outdoor unit quiet
—	Both deactivated

- To stop operation, press  until both symbols disappear from the LCD.

Note: Econo operation can be only set when the unit is running. Pressing  cancels the setting and  disappears from the LCD.

Note:  remains on the LCD, even if you turn off the unit using the user interface or indoor unit ON/OFF switch.

4.8 Flash Streamer (air cleaning) operation

Streamer generates a high-speed electron stream with a high oxidizing power, reducing bad odours. Together with the titanium apatite deodorizing filter and the air filters, this function cleans the air in the room.

INFORMATION

- The high-speed electrons are generated and go away inside the unit to ensure safe operation.
- The Streamer discharge may generate a fizzing sound.
- If the airflow becomes weak, the Streamer discharge may stop temporarily to prevent ozone smell.

4.8.1 To start/stop Flash Streamer (air cleaning) operation

- Press .

Result:  is displayed on the LCD and the air in the room is cleaned.

- To stop operation, press .

Result:  disappears from the LCD and operation stops.

4.9 OFF/ON timer operation

Timer functions are useful for automatically switching the air conditioner on/off at night or in the morning. You can also use OFF timer and ON timer in combination.

i INFORMATION

Program the timer again in case of:

- A breaker has turned the unit off.
- A power failure.
- After replacing batteries in the user interface.

i INFORMATION

The clock MUST be set correctly before using any timer functions. Refer to "3.3.1 To set the clock" [▶ 4].

4.9.1 To start/stop OFF timer operation

- 1 Press **Off** to start.

Result: **0:00** is displayed on the LCD, the timer lamp lights up, and OFF blinks. ☹ and the day of the week disappear from the LCD.



- 2 Press **Select** or **Select** to change the time setting.
- 3 Press **Off** again.

Result: OFF and the set time are displayed on the LCD.

Result: The timer lamp lights up.

i INFORMATION

Each time **Select** or **Select** is pressed, the time setting advances by 10 minutes. Holding the button down will change the setting rapidly.

- 4 To stop operation, press **Cancel**.

Result: **0:00** and OFF disappear from the LCD and the timer lamp goes off. ☹ and the day of the week are displayed on the LCD.

i INFORMATION

When you set the ON/OFF timer, the time setting is stored in the memory. The memory will be reset when the user interface batteries are replaced.

Use of night set mode in combination with OFF timer

The air conditioner automatically adjusts the temperature setting (0.5°C up in cooling, 2.0°C down in heating) to prevent excessive cooling/heating and ensure a comfortable sleeping temperature.

4.9.2 To start/stop ON timer operation

- 1 Press **On** to start.

Result: **6:00** is displayed on the LCD, the timer lamp lights up, and ON blinks. ☹ and the day of the week disappear from the LCD.

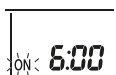

- 2 Press **Select** or **Select** to change the time setting.
- 3 Press **On** again.

Result: ON and the set time are displayed on the LCD. The timer lamp lights up.

i INFORMATION

Each time **Select** or **Select** is pressed, the time setting advances by 10 minutes. Holding the button down will change the setting rapidly.

- 4 To stop operation, press **Cancel**.

Result: **6:00** and ON disappear from the LCD and the timer lamp goes off. ☹ and the day of the week are displayed on the LCD.

4.9.3 To combine OFF timer and ON timer

- 1 To set the timers, refer to "4.9.1 To start/stop OFF timer operation" [▶ 9] and "4.9.2 To start/stop ON timer operation" [▶ 9].

Result: OFF and ON are displayed on the LCD.

Example:

Display	Current time	Set while...	Operation
OFF 7:00 ON 14:00	6:00	the unit is operating.	Stops at 7:00 and starts at 14:00.
		the unit is NOT operating.	Starts at 14:00.

Note: If the timer setting is active, the current time is NOT displayed on the LCD.

4.10 Weekly timer operation

With this operation, you can save up to 4 timer settings for each day of the week.

Example: Create a different setting from Monday to Friday and a different setting for weekends.

Day of the week	Setting example
Monday	<p>• Make up to 4 settings.</p>
Tuesday~Friday	<p>• Use the copy mode if the settings are the same as for Monday.</p>
Saturday	—
Sunday	<p>• Make up to 4 settings.</p>

- **ON-ON-ON-ON setting.** Enables scheduling the operation mode and set temperature.
- **OFF-OFF-OFF-OFF setting.** Only the turn off time can be set for each day.

Note: Be sure to aim the user interface at the indoor unit and check for a receiving tone when setting the Weekly timer operation.

i INFORMATION

The clock MUST be set correctly before using any timer functions. Refer to "3.3.1 To set the clock" [▶ 4].

i INFORMATION

- Weekly timer and ON/OFF timer operation CANNOT be used at the same time. The ON/OFF timer operation takes priority. Weekly timer will be in standby, ☹ WEEKLY disappears from the LCD. When the ON/OFF timer is completed, the Weekly timer becomes active.
- The day of the week, ON/OFF timer mode, time and temperature (only for ON timer) can be set with the Weekly timer. Other settings are based on previous ON timer setting.



4 Operation

4.10.1 To set Weekly timer operation

- 1 Press .

Result: The day of the week and the reservation number of the current day are displayed.



- 2 Press  or  to select the day of the week and the reservation number.

- 3 Press .

Result: The day of the week is set.  and ON blink.



- 4 Press  or  to select the mode.

Result: The setting will change as follows:





Display	Feature
ON	ON timer
OFF	OFF timer
Blank	Deletes reservation

- 5 Press .

Result: The ON/OFF timer mode is set.  and the time blink.





Note: Press  to return to the previous screen. If blank is selected, continue to step 9.

- 6 Press  or  to select the time. The time can be set between 0:00~23:50 in 10-minute intervals.

- 7 Press .

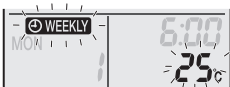
Result: The time is set and  and the temperature blink.



Note: Press  to return to the previous screen. If OFF timer is selected, continue to step 9.

- 8 Press  or  to select the desired temperature.

Note: The set temperature for the weekly timer is displayed only when setting the weekly timer mode.

INFORMATION

The temperature can be set between 10~32°C on the user interface, however:

- in cooling and automatic operation mode, the unit will operate at minimum 18°C even if is set at 10~17°C;
- in heating and automatic operation mode, the unit will operate at maximum 30°C even if is set at 31~32°C.

- 9 Press .

Result: The temperature and time are set for the ON timer. The time is set for the OFF timer. The timer lamp lights orange.

Result: A new reservation screen will appear.

- 10 Repeat the previous procedure to set another reservation or press  to complete the setting.



Result:  is displayed on the LCD.

Note: A reservation can be copied with the same settings to another day. Refer to "4.10.2 To copy reservations" [p 10].

4.10.2 To copy reservations

A reservation can be copied to another day. The complete reservation of the selected day of the week will be copied.



- 1 Press .

- 2 Press  or  to select the day of the week to be copied.

- 3 Press .

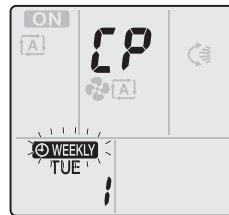
Result: The reservation of the selected day of the week will be copied.



- 4 Press  or  to select the destination day.

- 5 Press .

Result: The whole reservation is copied to the selected day and the timer lamp lights orange.

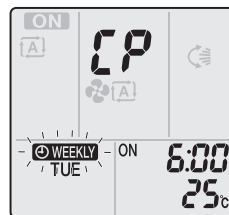

Note: To copy to another day, repeat the procedure.

- 6 Press  to complete the setting.

Result:  is displayed on the LCD.

Note: To change the reservation setting after copying, refer to "4.10.1 To set Weekly timer operation" [p 10].



4.10.3 To confirm reservations

You can confirm if all reservations are set to your needs.

- 1 Press .

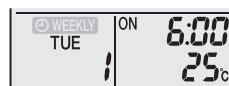
Result: The day of the week and the reservation number of the current day are displayed.



- 2 Press  or  to select the day of the week and reservation number to be confirmed and check the reservation details.

Note: To change the reservation setting, refer to "4.10.1 To set Weekly timer operation" [p 10].

- 3 Press  to exit the confirmation mode.

4.10.4 To deactivate and reactivate Weekly timer operation

- 1 To deactivate the Weekly timer, press **Weekly** while **WEEKLY** is displayed on the LCD.

Result: **WEEKLY** disappears from the LCD and the timer lamp goes off.

- 2 To reactivate the Weekly timer, press **Weekly** again.

Result: The last set reservation mode will be used.

4.10.5 To delete reservations

To delete individual reservations

Use this function if you want to delete a single reservation setting.

- 1 Press .

Result: The day of the week and the reservation number are displayed.

- 2 Press  or  to select the day of the week to be deleted.

- 3 Press **Next**.

Result: **WEEKLY**, ON, and OFF blink.

- 4 Press  or  and select "blank".

Result: The setting will change as follows:



- 5 Press **Next**.

Result: The selected reservation is deleted.

- 6 Press  to exit.

Result: Remaining reservations will be active.

To delete a reservation for each day of the week

Use this function if you want to delete all reservation settings for one day of the week. This can be used in confirmation or setting mode.

- 1 Press  or  to select the day of the week to be deleted.

- 2 Hold **Weekly** for about 5 seconds.

Result: All reservations for the selected day will be deleted.

To delete all reservations

Use this function if you want to delete all reservations for all days of the week in one go. This procedure CANNOT be used in the setting mode.

- 1 Hold **Weekly** for about 5 seconds while in the default display.

Result: All reservations will be deleted.

4.11 Wireless LAN connection

The customer is responsible for providing:

- Smartphone or tablet with minimum supported version of Android or iOS, specified on <http://www.onlinecontroller.daikineurope.com>
- Internet line and communication device, such as a modem, router, etc.
- Wireless LAN access point
- Installed free **Daikin Online Controller** application

Note: If needed, the SSID number and the KEY are located on the unit or can be found in the accessory bag.

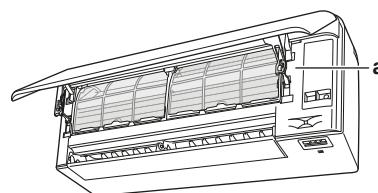

a Label with SSID number and password

4.11.1 Precautions when using the wireless adapter

Do NOT use near:

- **Medical equipment.** E.g. persons using cardiac pacemakers or defibrillators. This product may cause electromagnetic interference.
- **Auto-control equipment.** E.g. automatic doors or fire alarm equipment. This product may cause faulty behaviour of the equipment.
- **Microwave oven.** It may affect wireless LAN communications.

4.11.2 To install the Daikin Online Controller application

- 1 Open:
 - Google Play for appliances using Android.
 - App Store for appliances using iOS.
- 2 Search for **Daikin Online Controller**.
- 3 Follow the directions on the screen to install.

4.11.3 To set the wireless connection

There are two options to connect the wireless adapter with your smart device.

- **Connect the wireless adapter to your smart device directly.**
- **Connect the wireless adapter to your home network.** The wireless adapter will communicate with your smart device in your home network using a modem, router or a similar device.

For more information and FAQ refer to:



<http://www.onlinecontroller.daikineurope.com/>.

- 1 Stop the operation before setting the wireless connection.
- 2 Use the user interface to choose the wireless adapter setting menu.

Menu	Description
1	—
2	WPS setting
3	AP mode
4	RUN mode (SSID + KEY)
R	Reset to factory default
OFF	Wireless adapter OFF

To connect the wireless adapter to your device directly

- 1 Hold  for at least 5 seconds in the default screen.

Result: The confirmation display (menu 1) appears.
- 2 Press repeatedly  or  until the AP mode display (menu 3) appears.

4 Operation

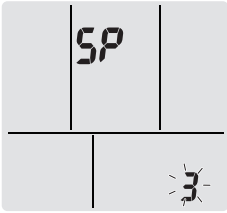

- 3 Press to confirm the selection.
Result: 3 is blinking. The operation and timer LEDs are blinking alternately.
- 4 Connect your smart device to the access point in the same way as to a standard wireless network.
- 5 Enter the SSID number and password located on the unit or in the accessory set.
- 6 Press to exit the menu.

Result: The display will return to the default screen.

To connect the wireless adapter to your home network

The wireless adapter can be connected to your home network using the:

- WPS button on the router (if present),
- SSID and KEY number located on the unit.

To connect using the WPS button

- 1 Hold for at least 5 seconds in the default screen.
Result: The confirmation display (menu 1) appears.
- 2 Press repeatedly or until the WPS setting display (menu 2) appears.

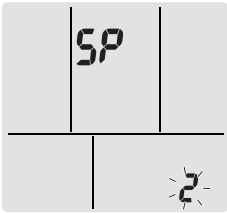

- 3 Press to confirm the selection.
Result: 2 is blinking. The timer LED is blinking.
- 4 Press the WPS button on your communication device (e.g. router) within approximately 1 minute. Refer to the manual of your communication device.

INFORMATION

If the connection with your router is not possible, try procedure "To connect using SSID and KEY number" ▶ 12].

- 5 Press to exit the menu.

Result: The display will return to the default screen.

To connect using SSID and KEY number

- 1 Hold for at least 5 seconds in the default screen.
Result: The confirmation display (menu 1) appears.
- 2 Press repeatedly or until the AP mode display (menu 3) appears.

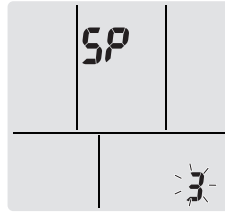

- 3 Press to confirm the selection.
Result: 3 is blinking. The operation and timer LEDs are blinking alternately.
- 4 Connect your smart device to the access point in the same way as to a standard wireless network.
- 5 Enter the SSID number and password located on the unit or in the accessory set.
- 6 Open the Daikin Online Controller application and follow the steps on the screen.
Result: Wireless adapter mode will automatically change from the AP mode to the RUN mode, the timer LED is blinking.
- 7 Press to exit the menu.

Result: The display will return to the default screen.

To reset the connection setting to the factory default

Reset the connection setting to the factory default in case you want to:

- switch between the WPS and the AP connection option,
- disconnect the Wi-Fi adapter and the communication device (e.g. router) or smart device,
- repeat the setting if the connection was unsuccessful.

- 1 Hold for at least 5 seconds in the default screen.
Result: The confirmation display (menu 1) appears.
- 2 Press repeatedly or until the A display (menu 8) appears.

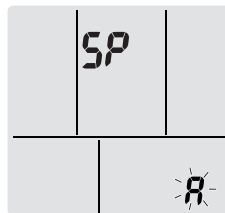

- 3 Hold for at least 2 seconds to confirm the selection.
Result: 8 is blinking. The setting is reset to the factory default.
- 4 Press to exit the menu.
Result: The display will return to the default screen.

To turn off the wireless connection

You can turn off the wireless connection using:





- the wireless adapter ON/OFF button on the unit,
- the user interface.

To use the wireless adapter ON/OFF switch



- 1 Press the wireless adapter ON/OFF switch.
Result: The wireless adapter communication is OFF.

Note: Press the ON/OFF switch again to turn on the wireless adapter.

To use the user interface

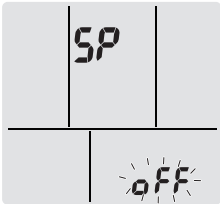
- 1 Hold  for at least 5 seconds in the default screen.
Result: The confirmation display (menu ) appears.
- 2 Press repeatedly  or  until the OFF menu appears.



- 3 Hold  for at least 2 seconds to confirm the selection.
Result: **OFF** is blinking. Communication is OFF.
- 4 Press  to exit the menu.

Result: The display will return to the default screen.

5 Energy saving and optimum operation



INFORMATION

- Even if the unit is turned OFF, it consumes electricity.
- When the power turns back on after a power break, the previously selected mode will be resumed.



CAUTION

NEVER expose little children, plants or animals directly to the airflow.



WARNING

Do NOT place objects below the indoor and/or outdoor unit that may get wet. Otherwise condensation on the unit or refrigerant pipes, air filter dirt or drain blockage may cause dripping, and objects under the unit may get dirty or damaged.



WARNING

Do NOT place a flammable spray bottle near the air conditioner and do NOT use sprays near the unit. Doing so may result in a fire.



CAUTION

Do NOT operate the system when using a room fumigation-type insecticide. Chemicals could collect in the unit, and endanger the health of people who are hypersensitive to chemicals.

Observe the following precautions to ensure the system operates properly.

- Prevent direct sunlight from entering a room during cooling operation by using curtains or blinds.
- Make sure the area is well ventilated. Do NOT block any ventilation openings.
- Ventilate often. Extended use requires special attention to ventilation.
- Keep doors and windows closed. If the doors and windows remain open, air will flow out of your room causing a decrease in the cooling or heating effect.
- Be careful NOT to cool or heat too much. To save energy, keep the temperature setting at a moderate level.

- NEVER place objects near the air inlet or the air outlet of the unit. Doing so may cause a reduced heating/cooling effect or stop operation.
- Turn off the main power supply switch to the unit when the unit is NOT used for longer periods of time. If the main power supply switch is on, the unit consumes electricity. Before restarting the unit, turn on the main power supply switch 6 hours before operation to ensure smooth running.
- Condensation may form if the humidity is above 80% or if the drain outlet gets blocked.
- Adjust the room temperature properly for a comfortable environment. Avoid excessive heating or cooling. Notice that it may take some time for the room temperature to reach the set temperature. Consider using the timer setting options.
- Adjust the air flow direction to avoid cool air from gathering on the floor or warm air against the ceiling. (Up during cooling or dry operation to the ceiling and down during heating operation.)
- Avoid direct air flow to room inhabitants.
- Operate the system within the recommended temperature range (26~28°C for cooling and 20~24°C for heating) to save energy.

6 Maintenance and service

6.1 Overview: Maintenance and service

The installer has to perform a yearly maintenance.

About the refrigerant

This product contains fluorinated greenhouse gases. Do NOT vent gases into the atmosphere.

Refrigerant type: R32

Global warming potential (GWP) value: 675



NOTICE

Applicable legislation on **fluorinated greenhouse gases** requires that the refrigerant charge of the unit is indicated both in weight and CO₂ equivalent.

Formula to calculate the quantity in CO₂ equivalent tonnes: GWP value of the refrigerant × total refrigerant charge [in kg] / 1000

Please contact your installer for more information.



WARNING

The refrigerant inside the unit is mildly flammable, but normally does NOT leak. If the refrigerant leaks in the room and comes in contact with fire from a burner, a heater, or a cooker, this may result in fire, or the formation of a harmful gas.

Turn off any combustible heating devices, ventilate the room, and contact the dealer where you purchased the unit.

Do NOT use the unit until a service person confirms that the part from which the refrigerant leaked has been repaired.



WARNING

- Do NOT pierce or burn refrigerant cycle parts.
- Do NOT use cleaning materials or means to accelerate the defrosting process other than those recommended by the manufacturer.
- Be aware that the refrigerant inside the system is odourless.

6 Maintenance and service

WARNING

The appliance shall be stored in a room without continuously operating ignition sources (example: open flames, an operating gas appliance or an operating electric heater).

NOTICE

Maintenance **MUST** be done by an authorized installer or service agent.

We recommend performing maintenance at least once a year. However, applicable legislation might require shorter maintenance intervals.

DANGER: RISK OF ELECTROCUTION

To clean the air conditioner or air filter, be sure to stop operation and turn all power supplies off. Otherwise, an electric shock and injury may result.

WARNING

To prevent electrical shocks or fire:

- Do NOT rinse the unit.
- Do NOT operate the unit with wet hands.
- Do NOT place any objects containing water on the unit.

CAUTION

After a long use, check the unit stand and fitting for damage. If damaged, the unit may fall and result in injury.

CAUTION

Do NOT touch the heat exchanger fins. These fins are sharp and could result in cutting injuries.

WARNING

Be careful with ladders when working in high places.

6.2 To clean the indoor unit and user interface

NOTICE

- Do NOT use gasoline, benzene, thinner polishing powder or liquid insecticide. **Possible consequence:** Discoloration and deformation.
- Do NOT use water or air of 40°C or higher. **Possible consequence:** Discoloration and deformation.
- Do NOT use polishing compounds.
- Do NOT use a scrubbing brush. **Possible consequence:** The surface finishing peels off.

DANGER: RISK OF ELECTROCUTION

Before cleaning, be sure to stop the operation, turn the breaker off or pull out the supply cord. Otherwise, an electric shock and injury may result.

- 1 Clean with a soft cloth. If it is difficult to remove stains, use water or a neutral detergent.

6.3 To clean the front panel

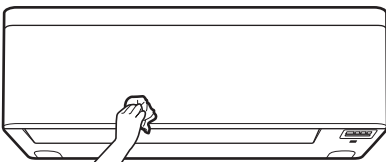

- 1 Clean the front panel with a soft cloth. If it is difficult to remove stains, use water or a neutral detergent.

6.4 To open the front panel

Open the front panel using the user interface.

- 1 Stop operation.
- 2 Hold  on the user interface for at least 2 seconds.

Result: The front panel will open.

Note: Press and hold  again for at least 2 seconds to close the front panel.

- 3 Turn the power supply off.
- 4 Pull down both locks on the back of the front panel.
- 5 Open the front panel until the support fits into the fixing tab.

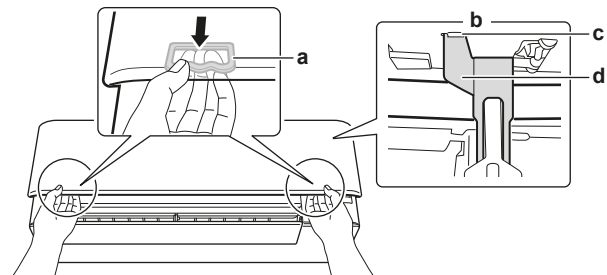

- a Lock (1 on each side)
- b Backside of the front panel
- c Fixing tab
- d Support

INFORMATION

If you **CANNOT** find the user interface or you use another optional controller. Pull the front panel carefully up by hand as shown in the following figure.

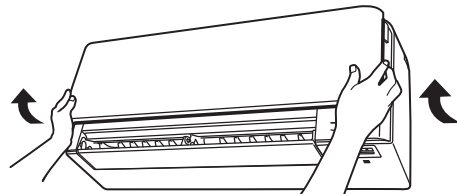

6.5 About the air filters

Operating the unit with dirty filters means that the filter:

- CANNOT deodorize the air,
- CANNOT clean the air,
- poor heating/cooling,
- causes odour.

6.6 To clean the air filters

- 1 Push the tab at the centre of each air filter, then pull it down.
- 2 Pull out the air filters.

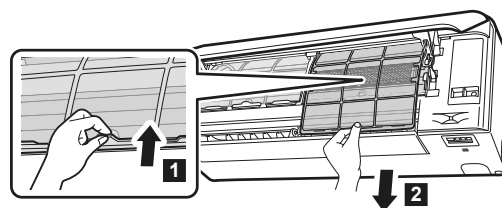

- 3 Remove the titanium apatite deodorizing filter and silver particle filter from the tabs.

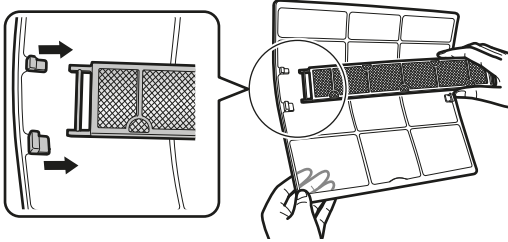

- 4 Wash the air filters with water or clean them with a vacuum cleaner.

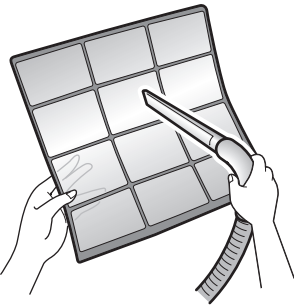

- 5 Soak in lukewarm water for about 10 to 15 minutes.

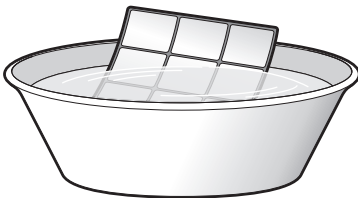

i INFORMATION

- If the dust does NOT come off easily, wash the air filters with a neutral detergent diluted in lukewarm water. Dry the air filters in the shade.
- Be sure to remove the titanium apatite deodorizing and silver particle filters.
- It is recommended to clean the air filters every 2 weeks.

6.7 To clean the titanium apatite deodorizing filter and the silver particle filter (Ag-ion filter)

i INFORMATION

Clean the filter with water every 6 months.

- 1 Remove the dust from the filter with a vacuum cleaner.

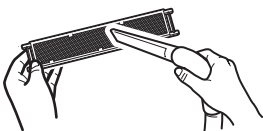

- 2 Soak the filter for 10 to 15 minutes in warm water. Do NOT remove the filter from the frame.



- 3 After washing, shake off remaining water and dry the filter in the shade. Do NOT wring out the filter when removing water.

6.8 To replace the titanium apatite deodorizing filter and the silver particle filter (Ag-ion filter)

i INFORMATION

Replace the filter every 3 years.

- 1 Remove the tabs on the filter frame and replace the filter with a new one.

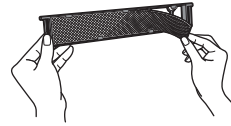

i INFORMATION

- Do NOT throw away the filter frame, but use it again.
- Dispose of the old filter as non-flammable waste.

6.9 To close the front panel

- 1 Set the filters as they were.
- 2 Lift the front panel slightly and remove the support from the fixing tab.

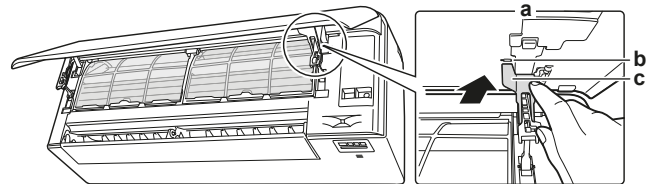

- a Backside of the front panel
- b Fixing tab
- c Support

- 3 Close the front panel.

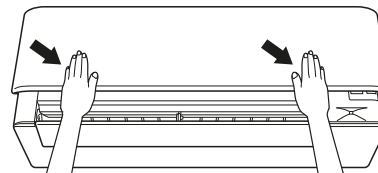

- 4 Gently press the front panel down until it clicks.

6.10 To remove the front panel

i INFORMATION

Remove the front panel only in case it MUST be replaced.

- 1 Open the front panel. See "6.4 To open the front panel" [p 14].
- 2 Open the panel locks located on the back side of the panel (1 on each side).

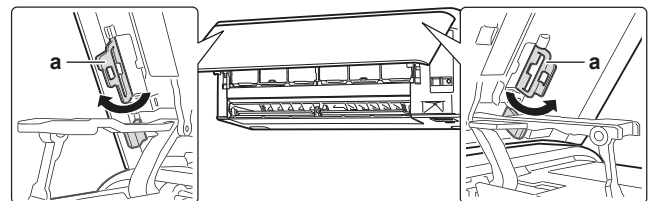

- a Panel lock

- 3 Push the right arm lightly to the right to disconnect the shaft from the shaft slot on the right side.

7 Troubleshooting

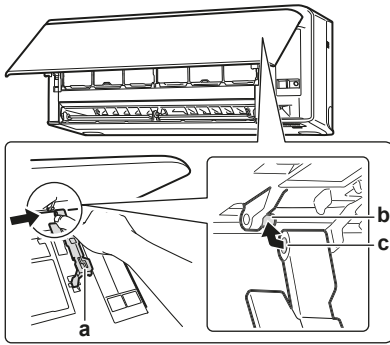

- a Arm
- b Shaft
- c Shaft slot

- 4 Disconnect the front panel shaft from the shaft slot on the left side.

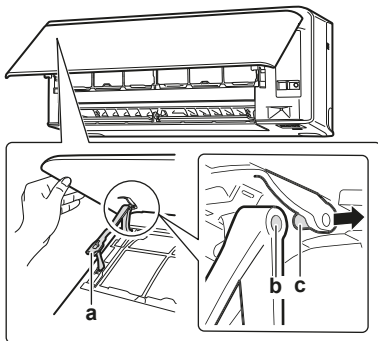

- a Arm
- b Shaft slot
- c Shaft

- 5 Remove the front panel.
- 6 To re-install the front panel perform the steps in the opposite order.

6.11 To take following items into account before a long idle period

Operate the unit several hours in **fan only** mode to dry the inside of the unit.

- 1 Press **Mode** and select operation.
- 2 Press and start operation.
- 3 After operation stops, turn the breaker off.
- 4 Clean the air filters and replace them in their original position.
- 5 Remove the batteries from the user interface.

INFORMATION

It is recommended to have periodical maintenance performed by a specialist. For specialist maintenance, contact your dealer. Maintenance costs shall be borne by the customer.

In certain operating conditions the inside of the unit may get dirty after several seasons of use. This results in poor performance.

7 Troubleshooting

If one of the following malfunctions occur, take the measures shown below and contact your dealer.



WARNING

Stop operation and shut off the power if anything unusual occurs (burning smells etc.).

Leaving the unit running under such circumstances may cause breakage, electric shock or fire. Contact your dealer.

The system MUST be repaired by a qualified service person.

Malfunction	Measure
If a safety device such as a fuse, a breaker or an earth leakage breaker frequently actuates or the ON/OFF switch does NOT properly work.	Turn OFF the main power switch.
If water leaks from the unit.	Stop the operation.
The operation switch does NOT work well.	Turn OFF the power supply.
If the user interface display indicates the unit number, the operation lamp flashes and the malfunction code appears.	Notify your installer and report the malfunction code.

If the system does NOT operate properly except for the above mentioned cases and none of the above mentioned malfunctions is evident, investigate the system in accordance with the following procedures.



INFORMATION

Refer to the reference guide located on <http://www.daikineurope.com/support-and-manuals/product-information/> for more troubleshooting tips.

If after checking all above items, it is impossible to fix the problem yourself, contact your installer and state the symptoms, the complete model name of the unit (with manufacturing number if possible) and the installation date (possibly listed on the warranty card).

7.1 Troubleshooting for wireless connection adapter

The following table provides a brief description of how to deal with some problems. If none of the following solutions fix the problem, go to <http://www.onlinecontroller.daikineurope.com/> for more information and FAQ.

Problem	Measure
Connection to the WLAN adapter is not possible (none of the LEDs are blinking).	<ul style="list-style-type: none"> ▪ Try operating the unit with the user interface. ▪ Check if the power is on. ▪ Turn the unit off and back on again.
The WLAN adapter is NOT visible on the unit overview screen (Home screen) after configuration of the WLAN adapter (WPS option).	<ul style="list-style-type: none"> ▪ Make sure the wireless LAN adapter is close enough to the communication device. ▪ Check if communication is OK. ▪ Make sure that the smart device is connected to the same wireless network as the WLAN adapter. ▪ Try resetting to the factory default and repeat the setting. See "To reset the connection setting to the factory default" [▶ 12].

Problem	Measure
The WLAN adapter is NOT visible in the available Wi-Fi networks list on the smart device (Access point option).	<ul style="list-style-type: none"> ▪ Try switching between access point and WPS setting to change the wireless channel. The wireless channel MUST be between 1~11. ▪ Check if communication is OK. ▪ Try resetting to the factory default and repeat the setting. See "To reset the connection setting to the factory default" [▶ 12].
Displayed indoor/outdoor temperature/humidity value in Online Controller differs from the value measured by other appliances.	<ul style="list-style-type: none"> ▪ Online Controller displays indoor/outdoor temperature/humidity only for the indoor/outdoor unit's surrounding. ▪ Measured temperature/humidity for other appliances may differ due to different condition around the unit (e.g. direct sunlight, frost accumulation...) ▪ Temperature/humidity displayed in Online Controller is only referential.

8 Disposal



NOTICE

Do NOT try to dismantle the system yourself: dismantling of the system, treatment of the refrigerant, oil and other parts MUST comply with applicable legislation. Units MUST be treated at a specialised treatment facility for reuse, recycling and recovery.







Copyright 2017 Daikin

DAIKIN INDUSTRIES CZECH REPUBLIC s.r.o.

U Nové Hospody 1/1155, 301 00 Plzeň Skvrňany, Czech Republic

DAIKIN EUROPE N.V.

Zandvoordestraat 300, B-8400 Oostende, Belgium

3P485919-7S 2020.05