

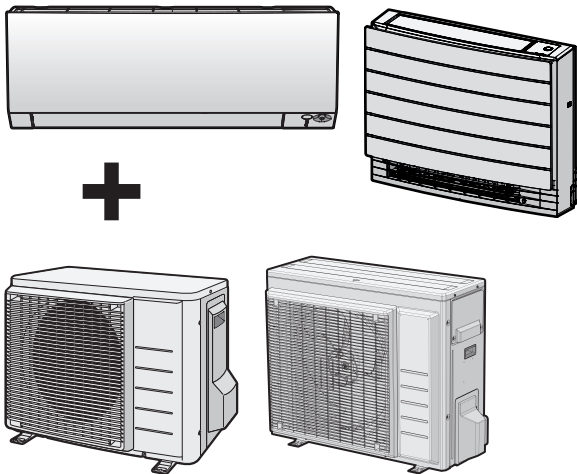

Service manual
Split New Perfera R32



RXM20~71R
ARXM25~71R

FTXM20~71R
ATXM25~50R

FVXM25~50A

Disclaimer

The present publication is drawn up by way of information only and does not constitute an offer binding upon Daikin Europe N.V.. Daikin Europe N.V. has compiled the content of this publication to the best of its knowledge. No express or implied warranty is given for the completeness, accuracy, reliability or fitness for particular purpose of its content and the products and services presented therein. Specifications are subject to change without prior notice. Daikin Europe N.V. explicitly rejects any liability for any direct or indirect damage, in the broadest sense, arising from or related to the use and/or interpretation of this publication. All content is copyrighted by Daikin Europe N.V..

Version log

Version code	Description	Date
ESIE20-11	Document release	January 2021
ESIE20-11A	See below	April 2021

The following updates have been applied to the Service Manual:

- Outdoor unit models RXM-R9 and ARXM-R9 added.
- Technical data – Field settings: To reduce maximum sound levels added.

Version code	Description	Date
ESIE20-11B	See below	February 2022

The following updates have been applied to the Service Manual:

- Compressor: To perform an electrical check of the compressor updated for safety reasons.

Version code	Description	Date
ESIE20-11C	See below	January 2023

The following updates have been applied to the Service Manual:

- Indoor unit models FVXM-A9 added.
- Outdoor unit models RXM35R5V1B6 added.
- Troubleshooting: Error codes A0-00 and CH-00 added.
- Components: R32 leak detection sensor check and repair procedures added.
- Technical data – Wiring diagram: Wiring diagrams for new models added.

Table of Contents

1	Safety precautions	7
1.1	Meaning of warnings and symbols	7
1.2	Dangers	8
1.3	Warnings	8
1.4	Cautions	14
1.5	Notices	14
2	General operation	15
3	Troubleshooting	16
3.1	To display the error code on the user interface	16
3.2	To reset the error code via remote controller	16
3.3	To reset the error code via outdoor unit	16
3.4	To perform a test run	17
3.4.1	To perform a test run using the user interface	17
3.5	Error based troubleshooting	18
3.5.1	A0-00 – R32 leakage detection	18
3.5.2	A1-00 – PCB abnormality	19
3.5.3	A5-00 – Outdoor unit: High pressure peak cut / freeze protection problem	19
3.5.4	A6-00 – Indoor unit fan motor abnormality	20
3.5.5	AH-00 – Streamer unit abnormality	21
3.5.6	C4-00 – Heat exchanger temperature sensor problem	21
3.5.7	C9-00 – Room thermistor abnormality	22
3.5.8	CC-00 – Humidity sensor abnormality	22
3.5.9	CH-00 – R32 leak detection sensor abnormality	23
3.5.10	E1-00 – Outdoor unit: PCB defect	24
3.5.11	E3-00 – Outdoor unit: Actuation of high pressure switch	25
3.5.12	E5-00 – Outdoor unit: Overheat of inverter compressor motor	26
3.5.13	E6-00 – Outdoor unit: Compressor startup defect	27
3.5.14	E7-00 – Outdoor unit: Malfunction of outdoor unit fan motor	28
3.5.15	E8-00 – Outdoor unit: Power input overvoltage	28
3.5.16	EA-00 – Outdoor unit: Cool/heat switchover problem	29
3.5.17	F3-00 – Outdoor unit: Malfunction of discharge pipe temperature	30
3.5.18	F6-00 – Outdoor unit: Abnormal high pressure in cooling	31
3.5.19	F8-00 – System shutdown due to compressor internal temperature abnormality	31
3.5.20	H0-00 – Outdoor unit: Voltage/current sensor problem	32
3.5.21	H3-00 – Outdoor unit: Malfunction of high pressure switch	33
3.5.22	H6-00 – Outdoor unit: Malfunction of position detection sensor	34
3.5.23	H8-00 – Outdoor unit: Malfunction of compressor input system	35
3.5.24	H9-00 – Outdoor unit: Malfunction of outdoor air thermistor	35
3.5.25	J3-00 – Outdoor unit: Malfunction of discharge pipe thermistor	36
3.5.26	J6-00 – Outdoor unit: Malfunction of heat exchanger thermistor	36
3.5.27	L3-00 – Outdoor unit: Electrical box temperature rise problem	36
3.5.28	L4-00 – Outdoor unit: Malfunction of inverter radiating fin temperature rise	37
3.5.29	L5-00 – Outdoor unit: Inverter instantaneous overcurrent	38
3.5.30	P4-00 – Outdoor unit: Malfunction of radiating fin temperature sensor	39
3.5.31	U0-00 – Outdoor unit: Shortage of refrigerant	39
3.5.32	U2-00 – Outdoor unit: Defect of power supply voltage	40
3.5.33	U4-00 – Indoor/outdoor unit communication problem	41
3.5.34	UA-00 – Indoor unit, outdoor unit mismatching problem	42
3.5.35	UH-00 – Malfunction of system	43
3.6	Symptom based troubleshooting	44
3.6.1	Operation does not start	44
3.6.2	Operation sometimes stops	44
3.6.3	Operation starts but the unit does not cool/heat	45
3.6.4	Operating noise and vibrations	46
3.6.5	Abnormal high pressure	47
3.6.6	Abnormal low pressure	48
3.6.7	Indoor fan starts operating but the compressor does not operate	49
3.6.8	Operation starts and the unit stops immediately	50
3.6.9	Operation stops, unit cannot start for a while	50
3.6.10	Unit discharges white mist	51
3.6.11	Humidifying problem	51
3.6.12	Swing flap does not operate	51

4	Components	52
4.1	4-way valve.....	52
4.1.1	Checking procedures.....	52
4.1.2	Repair procedures.....	56
4.2	Compressor.....	60
4.2.1	Checking procedures.....	60
4.2.2	Repair procedures.....	67
4.3	Compressor thermal protector.....	76
4.3.1	Checking procedures.....	76
4.3.2	Repair procedures.....	78
4.4	Damper motor.....	81
4.4.1	Checking procedures.....	81
4.4.2	Repair procedures.....	83
4.5	Expansion valve.....	85
4.5.1	Checking procedures.....	85
4.5.2	Repair procedures.....	89
4.6	High pressure switch.....	93
4.6.1	Checking procedures.....	93
4.6.2	Repair procedures.....	95
4.7	Humidity sensor.....	97
4.7.1	Checking procedures.....	97
4.7.2	Repair procedures.....	98
4.8	Indoor unit fan motor.....	100
4.8.1	Wall mounted indoor units.....	100
4.8.2	Floor standing indoor units.....	103
4.9	Indoor unit main PCB.....	110
4.9.1	Checking procedures.....	110
4.9.2	Repair procedures.....	114
4.10	Indoor unit power PCB.....	116
4.10.1	Checking procedures.....	116
4.10.2	Repair procedures.....	121
4.11	Intelligent eye sensor.....	125
4.11.1	Checking procedures.....	125
4.11.2	Repair procedures.....	128
4.12	Main PCB.....	129
4.12.1	Class 20~35 units.....	129
4.12.2	Class 42~71 units.....	139
4.13	Outdoor unit fan motor.....	147
4.13.1	Class 20~35 units.....	147
4.13.2	Class 42~71 units.....	151
4.14	Plate work.....	157
4.14.1	Outdoor unit.....	157
4.14.2	Indoor unit.....	163
4.15	R32 leak detection sensor.....	173
4.15.1	Checking procedures.....	173
4.15.2	Repair procedures.....	174
4.16	Reactor.....	176
4.16.1	Checking procedures.....	176
4.16.2	Repair procedures.....	179
4.17	Streamer unit.....	179
4.17.1	Checking procedures.....	179
4.17.2	Repair procedures.....	180
4.18	Swing flap motor.....	181
4.18.1	Wall mounted indoor units - Class 20~42.....	181
4.18.2	Wall mounted indoor units - Class 50~71.....	184
4.18.3	Floor standing indoor units.....	188
4.19	Swing raster motor.....	191
4.19.1	Checking procedures.....	191
4.19.2	Repair procedures.....	192
4.20	Thermistors.....	199
4.20.1	Checking procedures.....	199
4.20.2	Repair procedures.....	203
4.21	Wifi control PCB.....	207
4.21.1	Checking procedures.....	207
4.21.2	Repair procedures.....	208
5	Third party components	212
5.1	Electrical circuit.....	212
5.1.1	Checking procedures.....	212

5.1.2	Repair procedures	213
5.2	Refrigerant circuit	214
5.2.1	Checking procedures	214
5.2.2	Repair procedures	219
5.3	External factors	223
5.3.1	Checking procedures	223
6	Maintenance	225
6.1	To clean the outdoor unit heat exchanger	225
6.2	To clean the indoor unit heat exchanger	225
6.3	To clean the indoor unit heat exchanger in extreme condition	226
6.4	To clean the indoor unit and wireless remote control	226
6.5	To clean the front panel	227
6.6	To clean the air filters	228
6.7	To clean the titanium apatite deodorising filter and the silver particle filter (Ag-ion filter).....	231
6.8	To replace the titanium apatite deodorising filter and the silver particle filter (Ag-ion filter)	232
7	Technical data	234
7.1	Detailed information setting mode	234
7.1.1	Detailed information setting mode: Indoor unit	234
7.1.2	Detailed information setting mode: Outdoor unit	234
7.1.3	Detailed information setting mode: Remote controller	234
7.2	Wiring diagram.....	235
7.2.1	Wiring diagram: Indoor unit.....	235
7.2.2	Wiring diagram: Outdoor unit.....	242
7.3	Piping diagram	247
7.3.1	Piping diagram: Indoor unit.....	247
7.3.2	Piping diagram: Outdoor unit.....	253
7.4	Component overview.....	257
7.4.1	Component overview: Outdoor unit.....	257
7.4.2	Component overview: Wall mounted indoor unit.....	259
7.4.3	Component overview: Floor standing indoor unit	261
7.5	Field information report	262
7.6	Service tools	265
7.7	Field settings	266
7.7.1	To control heating only mode	266
7.7.2	To adjust target set temperature in heating operation	266
7.7.3	To control the indoor unit fan during thermostat off in cooling.....	267
7.7.4	To change auto restart ON to OFF	268
7.7.5	To limit the angle of the upper swing flap	268
7.7.6	To reduce maximum sound levels	269

1 Safety precautions

The precautions described in this document cover very important topics, follow them carefully.

All activities described in the service manual must be performed by an authorized person.

If you are NOT sure how to install, operate or service the unit, contact your dealer.

In accordance with the applicable legislation, it might be necessary to provide a logbook with the product containing at least:

information on maintenance, repair work, results of tests, stand-by periods, ...

Also, at least, following information must be provided at an accessible place at the product:

- Instructions for shutting down the system in case of an emergency
- Name and address of fire department, police and hospital
- Name, address and day and night telephone numbers for obtaining service

In Europe, EN378 provides the necessary guidance for this logbook.

1.1 Meaning of warnings and symbols



DANGER

Indicates a situation that results in death or serious injury.



DANGER: RISK OF ELECTROCUTION

Indicates a situation that could result in electrocution.



DANGER: RISK OF BURNING/SCALDING

Indicates a situation that could result in burning/scalding because of extreme hot or cold temperatures.



DANGER: RISK OF EXPLOSION

Indicates a situation that could result in explosion.



WARNING

Indicates a situation that could result in death or serious injury.



WARNING: FLAMMABLE MATERIAL



CAUTION

Indicates a situation that could result in minor or moderate injury.



NOTICE

Indicates a situation that could result in equipment or property damage.



INFORMATION

Indicates useful tips or additional information.

1.2 Dangers



DANGER: RISK OF BURNING/SCALDING

- Do NOT touch the refrigerant piping, water piping or internal parts during and immediately after operation. It could be too hot or too cold. Give it time to return to normal temperature. If you MUST touch it, wear protective gloves.
- Do NOT touch any accidental leaking refrigerant.



DANGER: RISK OF ELECTROCUTION

- Turn OFF all power supply before removing the switch box cover, connecting electrical wiring or touching electrical parts.
- Where applicable, stop the equipment's operation first and allow (refrigerant) pressure to equalize, before turning OFF the power.
- Disconnect the power supply for more than 10 minutes, and measure the voltage at the terminals of main circuit capacitors or electrical components before servicing. The voltage MUST be less than 50 V DC before you can touch electrical components. For the location of the terminals, see the wiring diagram. If the measured voltage is still higher than 50 V DC, discharge the capacitors in a safe manner by using a dedicated capacitor discharge pen to avoid possibility of sparking.
- Do NOT touch electrical components with wet hands.
- Do NOT leave the unit unattended when the service cover is removed.
- Protect electric components from getting wet while the service cover is opened.

1.3 Warnings



WARNING

Improper installation or attachment of equipment or accessories could result in electrical shock, short-circuit, leaks, fire or other damage to the equipment. ONLY use accessories, optional equipment and spare parts made or approved by Daikin unless otherwise specified.



WARNING

Do NOT apply any permanent inductive or capacitance loads to the circuit without ensuring that this will NOT exceed the permissible voltage and current permitted for the equipment in use.

**WARNING**

If a fault exists that could compromise safety, Do NOT connect electrical supply to the circuit until it is satisfactorily dealt with. If the fault CANNOT be corrected immediately but it is necessary to continue operation, an adequate temporary solution MUST be used. This MUST be reported to the owner of the equipment so all parties are advised.

Initial safety checks MUST include that:

- capacitors are discharged: this MUST be done in a safe manner to avoid possibility of sparking,
- NO live electrical components and wiring are exposed while charging, recovering or purging the system.

**WARNING**

Make sure that the refrigerating piping and components are installed in a position where they are unlikely to be exposed to any corroding substance.

**WARNING**

Make sure installation, testing and applied materials comply with applicable legislation (on top of the instructions described in the Daikin documentation).

**WARNING**

Make sure the work site environment is clean and safe to work in. Beware of spilled fluids, like water, oil or other substances.

Protect bystanders from injury and property from possible damage cause by service works.

**WARNING**

If any work is to be conducted on the refrigerating equipment or any associated parts which involves brazing, an appropriate dry powder or CO₂ fire extinguisher MUST be present.

When charging the unit, an appropriate dry powder or CO₂ fire extinguisher MUST be present.

**WARNING**

No person carrying out work in relation to a refrigerating system which involves exposing any pipe work shall use any sources of ignition in such a manner that it may lead to the risk of fire or explosion. All possible ignition sources, including cigarette smoking, MUST be kept sufficiently far away from the site of installation, repairing, removing and disposal, during which refrigerant can possibly be released to the surrounding space. Prior to work taking place, the area around the equipment is to be surveyed to make sure that there are no flammable hazards or ignition risks. "No Smoking" signs MUST be displayed.

**WARNING**

Tear apart and throw away plastic packaging bags so that nobody, especially NOT children, can play with them. **Possible consequence:** suffocation.

**WARNING**

During tests, NEVER pressurise the product with a pressure higher than the maximum allowable pressure (as indicated on the nameplate of the unit).



WARNING

Make sure the total refrigerant charge is in accordance with the room size in which the unit is installed: please consult the detailed instructions on charging and allowed room sizes in the installation manual.



WARNING

- NEVER mix different refrigerants or allow air to enter the refrigerant system.
- NEVER charge recovered refrigerant from another unit. Use recovered refrigerant only on the same unit where it was recovered from, or have it recycled at a certified facility.



WARNING

When reconnecting a connector to the PCB, make sure to connect it on the correct location and do NOT apply force, as this may damage the connector or connector pins of the PCB.



WARNING

ALWAYS recover the refrigerant. Do NOT release them directly into the environment. Use a vacuum pump to evacuate the installation.



WARNING

Removal of refrigerant MUST be according to the following:

When breaking into the refrigerant circuit to make repairs, be sure to remove the refrigerant from the system first. The refrigerant charge MUST be recovered into the correct recovery cylinders.



WARNING

Take sufficient precautions in case of refrigerant leakage. If refrigerant gas leaks, ventilate the area immediately. Possible risks:

- Excessive refrigerant concentrations in a closed room can lead to oxygen deficiency.
- Toxic gas might be produced if refrigerant gas comes into contact with fire.



WARNING

- Under no circumstances, potential sources of ignition SHALL be used in the searching for or detection of refrigerant leaks. A halide torch (or any other detector using a naked flame) MUST NOT be used.
- Ensure that the detector is NOT a potential source of ignition and is suitable for the detection of R32.
- If a leak is suspected, all naked flames MUST be removed or extinguished.
- Leak detection fluids are also suitable for use with most refrigerants but the use of detergents containing chlorine MUST be avoided as the chlorine may react with the refrigerant and corrode the copper pipe-work.
- If a leakage of refrigerant is found which requires brazing, all of the refrigerant MUST be recovered from the system, or isolated (by means of shut-off valves) in a part of the system remote from the leak.
- Only use the electronic leak tester for R32. The old flame leak tester CANNOT be used on a system with HFC refrigerant because there is no chlorine component in the refrigerant. In case of R32 (HFC) refrigerant, any flame in contact with (leaking) refrigerant is extremely dangerous.

**WARNING**

- In order to prevent oxygen deficiency and R32 combustion, keep the room well-ventilated for a healthy work environment. Do NOT work in a confined space. If a refrigerant leak is detected in a confined room or an inadequately ventilated location, do NOT start the work until the area has been ventilated appropriately.
- If the work area is NOT located in the open air, make sure the work area is adequately ventilated before breaking into the system or conducting any brazing. The ventilation MUST continue to operate during the period that the work is carried out to prevent accumulation of refrigerant in the work area. The ventilation should safely disperse any released refrigerant and preferably ventilate to the open air.

**WARNING**

Ensure that no external live wiring is exposed while charging, recovering or purging the system. Sparks created when live wiring is short-circuited might ignite the refrigerant if it is leaked into the room while charging, recovering or purging the system.

**WARNING**

Ensure that the unit is properly earthed prior to conducting maintenance or service or charging the system with refrigerant. Do NOT earth the unit to a utility pipe, surge absorber, or telephone earth. Incomplete earthing may cause electrical shock.

**WARNING**

- ONLY use copper wires.
- Make sure the field wiring complies with the applicable legislation.
- All field wiring MUST be performed in accordance with the wiring diagram supplied with the product.
- NEVER squeeze bundled cables and make sure they do NOT come in contact with the piping and sharp edges. Make sure no external pressure is applied to the terminal connections.
- Make sure to install earth wiring. Do NOT earth the unit to a utility pipe, surge absorber, or telephone earth. Incomplete earth may cause electrical shock.
- Make sure to use a dedicated power circuit. NEVER use a power supply shared by another appliance.
- Make sure to install the required fuses or circuit breakers.
- Make sure to install an earth leakage protector. Failure to do so may cause electrical shock or fire.
- When installing the earth leakage protector, make sure it is compatible with the inverter (resistant to high frequency electric noise) to avoid unnecessary opening of the earth leakage protector.

**WARNING**

Make sure the markings on the unit remain visible and legible after inspection or repair work. Markings and signs that are illegible shall be corrected.

**WARNING**

- After finishing the electrical work, confirm that each electrical component and terminal inside the electrical components box is connected securely.
- Make sure all covers are closed before starting up the unit.



WARNING

- The area **MUST** be checked with an appropriate refrigerant detector prior to and during work, to ensure the technician is aware of potentially toxic or flammable atmospheres.
- Ensure that the leak detection equipment being used is suitable for use with all applicable refrigerants, i.e. non-sparking, adequately sealed or intrinsically safe.
- Prior to and during work, the area **MUST** be checked with an appropriate refrigerant detector capable of detecting R32 refrigerant, to ensure a work environment free of refrigerant.



WARNING

- Equipment **MUST** be labelled stating that it has been de-commissioned and emptied of refrigerant.
- The label **MUST** be dated and signed.
- For appliances containing flammable refrigerants, ensure that there are labels on the equipment stating the equipment contains flammable refrigerant.



WARNING

Before carrying out refrigerant recovery procedure, it is essential that the technician is completely familiar with the equipment and all its details. It is recommended good practice that all refrigerants are recovered safely. Prior to the task being carried out, an oil and refrigerant sample **MUST** be taken in case analysis is required prior to re-use of recovered refrigerant. It is essential that electrical power is available before the task is commenced.

- Become familiar with the equipment and its operation.
- Isolate system electrically.
- Ensure that mechanical handling equipment is available, if required, for handling refrigerant cylinders.
- Ensure that all personal protective equipment is available and is used correctly.
- Ensure that the recovery process is supervised at all times by a competent person.
- Ensure that recovery equipment and cylinders conform to the appropriate standards.
- If a vacuum is **NOT** possible, make a manifold so that refrigerant can be removed from various parts of the system.
- Make sure that cylinder is situated on the scales before recovery takes place.
- Start the recovery machine and operate in accordance with instructions.
- Do **NOT** overfill cylinders (no more than 60% volume liquid charge).
- Do **NOT** exceed the maximum working pressure of the cylinder, **NOT** even temporarily.
- When the cylinders have been filled correctly and the process completed, make sure that the cylinders and the equipment are removed from site promptly and all isolation valves on the equipment are closed.
- Recovered refrigerant **MUST NOT** be charged into another refrigerating system unless it has been cleaned and checked.



WARNING

All maintenance staff and others working in the local area **MUST** be instructed on the nature of work being carried out.

**WARNING**

Provide adequate measures to prevent that the unit can be used as a shelter by small animals. Small animals that make contact with electrical parts can cause malfunctions, smoke or fire.

**WARNING**

Prior to start working on systems containing flammable refrigerant, safety checks are necessary to ensure that the risk of ignition is minimised. Therefore, some instructions should be followed.

Please refer to the service manual for more information.

**WARNING**

- In case refrigerant recovery is required, use the appropriate service ports.
- If applicable for your unit, use the appropriate recovery mode or field setting to smoothly recover the refrigerant.
- ONLY use leak free hoses, couplings and manifolds in good working condition.
- ONLY use recovery cylinders designated and labelled to recover R32. Note that thread connection to the cylinder is counter clock.
- Always use a calibrated scale in good condition prior and during the refrigerant recovery process to determine the weight of the recovered refrigerant into the external refrigerant cylinder.
- Read the operation instructions of the recovery unit prior to connecting the recovery unit. Verify the recovery unit is suited for R32 refrigerant, check that it is in good working condition, has been properly maintained and that any associated electrical components are sealed to prevent ignition in the event of a refrigerant release. Consult manufacturer if in doubt.
- Do NOT overfill the refrigerant cylinder, confirm with the supplier of the refrigerant cylinder about maximum filling ratio if NOT mentioned on the refrigerant cylinder itself. Generally the maximum filling amount should be limited to 60% of the maximum volume of the cylinder.
- Do NOT exceed the maximum working pressure of the refrigerant cylinder, NOT even temporarily.
- When the cylinders have been filled correctly, and the refrigerant recovery process is completed, make sure that the cylinders and the equipment are removed from site promptly and all stop valves on the equipment are (kept) closed.
- The recovered refrigerant MUST be returned to the refrigerant supplier in the correct recovery cylinder, and the relevant waste transfer note arranged. Do NOT mix refrigerants in recovery units and especially NOT in cylinders.
- Recovered refrigerant MUST NOT be charged into another refrigerant system unless it has been cleaned and checked.

**WARNING**

If compressor is to be removed, ensure that the compressor has been evacuated to an acceptable level to make sure that flammable refrigerant does NOT remain within the lubricant. The evacuation process MUST be carried out prior to returning the compressor to the supplier. During the refrigerant recovery, confirm that the crankcase heater of the compressor body is energized to accelerate this process. When oil is drained from a system, it MUST be carried out safely.

**WARNING**

Make sure the ventilation machinery and outlets are operating adequately and are NOT obstructed.

1.4 Cautions



CAUTION

Wear adequate personal protective equipment (protective gloves, safety glasses,...) when installing, maintaining or servicing the system.



CAUTION

To avoid injury, do NOT touch the air inlet or aluminium fins of the unit.



CAUTION

- Do NOT place any objects or equipment on top of the unit.
- Do NOT sit, climb or stand on the unit.

1.5 Notices



NOTICE

- Make sure water quality complies with EU directive 2020/2184.
- Check the system for leaks after each repair/modification of the water side.
- Check drainage system(s) after repairs.
- Be careful when tilting units as water may leak.



NOTICE

Make sure refrigerant piping installation complies with applicable legislation. In Europe, EN378 is the applicable standard.



NOTICE

Make sure the field piping and connections are NOT subjected to stress.

2 General operation

The Split New Perfera is typically used for cooling or heating in residential applications.

The medium which is used to transfer the heat from inside to outside or vice versa, is refrigerant R32.

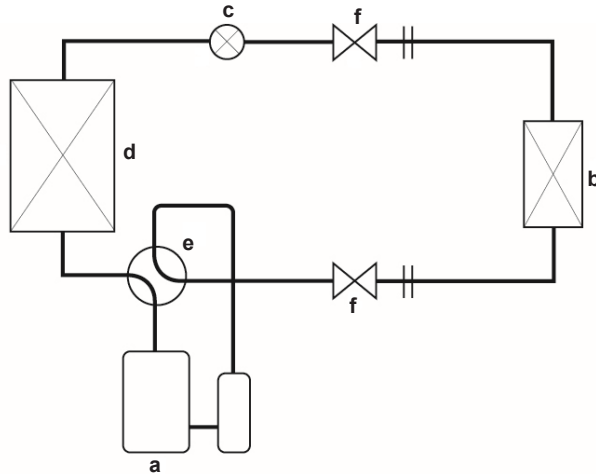

- a** Compressor
- b** Indoor heat exchanger
- c** Expansion valve
- d** Outdoor heat exchanger
- e** 4-way valve
- f** Stop valves

In case of cooling, the compressor builds up pressure and hence the temperature of the refrigerant is increased. The hot refrigerant is carried to the outdoor heat exchanger which will cool down the hot refrigerant by the fan.

The temperature of the refrigerant is further decreased by expansion through the expansion valve. The cold refrigerant flows into the indoor unit and is capable of taking up heat again. This is enabled by a fan that sucks indoor air over the heat exchanger.

This refrigerant is then transported to the compressor where temperature is built up again and the cycle restarts.

For heating, it's just the other way round.



INFORMATION

Some of the indoor unit models CAN be used as Multi application as well. For further general operation, please consult Multi Split service manual.

3 Troubleshooting

3.1 To display the error code on the user interface

- 1 Hold **Cancel** for about 5 seconds.
Result: **00** blinks in the temperature display section.
- 2 Press **Cancel** repeatedly until a continuous beep is heard.
Result: The code is now displayed on the display.



INFORMATION

- A short beep and 2 consecutive beeps indicate non-corresponding codes.
- To cancel the code display, hold **Cancel** for 5 seconds. The code will also disappear from the display if the button is NOT pressed within 1 minute.

3.2 To reset the error code via remote controller

Prerequisite: Problem is solved.

- 1 Press the ON/OFF button of the remote controller to reset the error.

To clear the error codes A0-00 and CH-00

- 1 On the home screen, (strongly) press **Mode** and **Temp** simultaneously.

Result: **5C** is displayed on the remote controller.

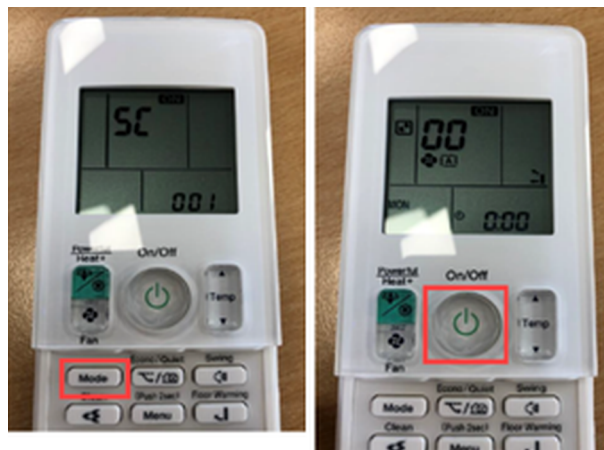

- 2 Press **Mode** to enter the setting.
Result: **00** is displayed on the remote controller.
- 3 Press **Temp** for more than 2 seconds.
- 4 Power OFF and ON the unit.

Result: Error code has been cleared.

3.3 To reset the error code via outdoor unit

Prerequisite: Problem is solved.

- 1 Perform a power reset to reset the error code.

3.4 To perform a test run

Prerequisite: Power supply MUST be in the specified range.

Prerequisite: Test run may be performed in cooling or heating mode.

Prerequisite: Test run should be performed in accordance with the operation manual of the indoor unit to make sure that all functions and parts are working properly.

- 1 In cooling mode, select the lowest programmable temperature. In heating mode, select the highest programmable temperature. Test run can be disabled if necessary.
- 2 When the test run is finished, set the temperature to a normal level. In cooling mode: 26~28°C, in heating mode: 20~24°C.
- 3 The system stops operating 3 minutes after the unit is turned OFF.









INFORMATION

- Even if the unit is turned OFF, it consumes electricity.
- When the power turns back on after a power break, the previously selected mode will be resumed.

3.4.1 To perform a test run using the user interface







Floor standing units

- 1 Press  to switch the system on.
- 2 Press the middle of  and  simultaneously.
- 3 Press  twice to choose  and confirm selection by pressing .

Result:  on the display indicates that the test run is selected. Test run operation will stop automatically after about 30 minutes.

- 4 To stop operation sooner, press the ON/OFF button.

Wall mounted units

- 1 Press  to switch the system on.
- 2 Press  and  simultaneously.
- 3 Press , select  and press .

Result: Test run operation will stop automatically after about 30 minutes.

- 4 To stop operation sooner, press .

3.5 Error based troubleshooting

3.5.1 A0-00 – R32 leakage detection

Trigger	Effect	Reset
Detection of R32 refrigerant gas leakage.	Outdoor unit stops operating. Indoor fan starts in fan ONLY. Blinking LED indoor unit.	After 320 seconds of NO gas detection, auto reset: <ul style="list-style-type: none"> ▪ A0 error disappears. ▪ Unit starts working again.
Detection of R32 refrigerant gas leakage 4 times within 1 hour.	Outdoor unit stops operating. Indoor fan starts in fan ONLY. Blinking LED indoor unit.	Manual reset, see "3.2 To reset the error code via remote controller" [▶ 16].
Detection of R32 refrigerant gas leakage continuously for 10 minutes.	Abnormality notice tone ^(a) .	

^(a) To stop the abnormality notice tone (continuous beep) in case of refrigerant leakage detection, press remote controller "cancel" button for 5 seconds.

To solve the error code



INFORMATION

It is recommended to perform the checks in the listed order.

- 1 Stop the outdoor unit operation for at least 30 minutes.
- 2 Using a leak tester, check the faulty indoor unit for refrigerant leak. If refrigerant leak is found, repair the leak.
- 3 If NO refrigerant leak was found, perform as described below.
- 4 Perform a check of the R32 leak detection sensor of the faulty indoor unit. See ["4.15 R32 leak detection sensor"](#) [▶ 173].

Possible cause: Faulty R32 leak detection sensor.

- 5 Check if any external (foreign) vapor substance influenced the functioning of the R32 leak detection sensor. Repair as needed.

Possible cause: External (foreign) vapor substance reacted with R32 leak detection sensor.

- 6 Perform a check of the indoor unit main PCB. See ["4.9 Indoor unit main PCB"](#) [▶ 110].

Possible cause: Faulty indoor unit main PCB.



INFORMATION

If all procedures listed above have been performed and the problem is still present, contact the helpdesk.

3.5.2 A1-00 – PCB abnormality

Trigger	Effect	Reset
The system CANNOT set the internal settings.	Unit will stop operating.	Power reset via outdoor unit.

To solve the error code

**INFORMATION**

It is recommended to perform the checks in the listed order.

- 1 Check for improper combination of the indoor unit and the outdoor unit. See the combination table in the Databook for more information.
- 2 Perform a check of the power supply, connections, wiring,... between the outdoor unit and the indoor unit. See "[5.1 Electrical circuit](#)" [▶ 212].

Possible cause: Faulty wiring between the outdoor unit and the indoor unit.

- 3 Check if the power supply is compliant with the regulations. See "[5.1 Electrical circuit](#)" [▶ 212].

Possible cause:

- Faulty or disturbance of the power supply (power supply MUST be within range of nominal operating voltage $\pm 4\%$),
- Power drop,
- Short circuit.

- 4 Perform a check of the indoor unit main PCB. See "[4.9 Indoor unit main PCB](#)" [▶ 110].

Possible cause: Faulty indoor unit main PCB.

**INFORMATION**

If all procedures listed above have been performed and the problem is still present, contact the helpdesk.

3.5.3 A5-00 – Outdoor unit: High pressure peak cut / freeze protection problem

Trigger	Effect	Reset
During cooling operation, indoor heat exchanger temperature is below 0°C (freeze-up protection control).	Unit will stop operating.	Automatic reset when temperature is within range.
During heating operation, indoor heat exchanger temperature is above 65°C (heating peak-cut control).		

To solve the error code

**INFORMATION**

It is recommended to perform the checks in the listed order.

- 1 Check for objects near the indoor unit that may block the airflow. See ["5.3 External factors"](#) [▶ 223].
Possible cause: Airflow of the indoor unit is blocked.
- 2 Clean the air filter of the indoor unit(s). See ["6 Maintenance"](#) [▶ 225].
Possible cause: Faulty or dirty air filter.
- 3 Clean the indoor unit heat exchanger. See ["6 Maintenance"](#) [▶ 225].
Possible cause: Dirty indoor unit heat exchanger.
- 4 Perform a check of the indoor unit heat exchanger thermistor. See ["4.20 Thermistors"](#) [▶ 199].
Possible cause: Faulty indoor unit heat exchanger thermistor.
- 5 Perform a check of the indoor unit main PCB. See ["4.9 Indoor unit main PCB"](#) [▶ 110].
Possible cause: Faulty indoor unit main PCB.



INFORMATION
If all procedures listed above have been performed and the problem is still present, contact the helpdesk.

3.5.4 A6-00 – Indoor unit fan motor abnormality

Trigger	Effect	Reset
The rotation speed of the fan motor is NOT detected while the output voltage to the fan is at its maximum.	Unit will stop operating.	Power reset via the outdoor unit.

To solve the error code



INFORMATION
It is recommended to perform the checks in the listed order.

- 1 Perform a check of the indoor unit main PCB. See ["4.9 Indoor unit main PCB"](#) [▶ 110].
Possible cause: Faulty indoor unit main PCB.
- 2 Perform a check of the indoor unit fan motor. See ["4.8 Indoor unit fan motor"](#) [▶ 100].
Possible cause: Faulty indoor unit fan motor.



INFORMATION
If all procedures listed above have been performed and the problem is still present, contact the helpdesk.

3.5.5 AH-00 – Streamer unit abnormality

Trigger	Effect	Reset
Streamer unit starts electric discharge when operation starts after approximately 90 to 180 seconds.	Unit will NOT stop operating.	Manual reset via user interface.

To solve the error code

**INFORMATION**

It is recommended to perform the checks in the listed order.

- 1 Perform a check of the streamer unit. See "[4.17 Streamer unit](#)" [▶ 179].

Possible cause: Faulty streamer unit.

**INFORMATION**

If all procedures listed above have been performed and the problem is still present, contact the helpdesk.

3.5.6 C4-00 – Heat exchanger temperature sensor problem

Trigger	Effect	Reset
Refrigerant liquid thermistor detects an open or short circuit during compressor operation.	Unit will stop operating.	Power reset.

To solve the error code

**INFORMATION**

It is recommended to perform the checks in the listed order.

- 1 Perform a check of the indoor unit heat exchanger thermistor. See "[4.20 Thermistors](#)" [▶ 199].

Possible cause: Faulty indoor unit heat exchanger thermistor.

- 2 Perform a check of the indoor unit main PCB. See "[4.9 Indoor unit main PCB](#)" [▶ 110].

Possible cause: Faulty indoor unit main PCB.

**INFORMATION**

If all procedures listed above have been performed and the problem is still present, contact the helpdesk.

3.5.7 C9-00 – Room thermistor abnormality

Trigger	Effect	Reset
Resistance value is out of range. Temperature measured $\leq -43.6^{\circ}\text{C}$ or $>90^{\circ}\text{C}$.	Unit will stop operating.	Automatic reset when resistance is within range.

To solve the error code



INFORMATION

It is recommended to perform the checks in the listed order.

- 1 Perform a check of the indoor unit air (room) thermistor. See "[4.20 Thermistors](#)" [▶ 199].

Possible cause: Faulty indoor unit air (room) thermistor.

- 2 Perform a check of the indoor unit main PCB. See "[4.9 Indoor unit main PCB](#)" [▶ 110].

Possible cause: Faulty indoor unit main PCB.



INFORMATION

If all procedures listed above have been performed and the problem is still present, contact the helpdesk.

3.5.8 CC-00 – Humidity sensor abnormality

Trigger	Effect	Reset
<ul style="list-style-type: none"> ▪ Disconnected sensor ▪ Broken sensor ▪ Communication error 	Unit will stop operating.	Manual reset via user interface.

To solve the error code



INFORMATION

It is recommended to perform the checks in the listed order.

- 1 Perform a check of the humidity sensor. See "[4.7 Humidity sensor](#)" [▶ 97].

Possible cause: Faulty humidity sensor.



INFORMATION

If all procedures listed above have been performed and the problem is still present, contact the helpdesk.

3.5.9 CH-00 – R32 leak detection sensor abnormality

Trigger	Effect	Reset
The R32 sensor NOT connected to indoor unit main PCB.	Indoor unit will stop operating.	Manual reset, see "3.2 To reset the error code via remote controller" [▶ 16].
R32 sensor PCB failure		
The R32 sensor detected operation of 10 years or more.		
The R32 sensor detected operation of 9.5 years or more.	Indoor unit continues operating. Blinking LED at indoor unit.	Not possible to reset.

To solve the error code

**INFORMATION**

It is recommended to perform the checks in the listed order.

- 1 Check wiring (insertion and continuity) on connector S903 on the indoor unit display PCB and connectors CN1-2 on the PCB of the R32 leak detection sensor. See ["7.2 Wiring diagram"](#) [▶ 235].

Possible cause: Faulty or damaged wiring between indoor unit display PCB and R32 leak detection sensor.

- 2 Check the operation time of the R32 leak detection sensor of the faulty indoor unit. If operation time is 10 years, replace the R32 leak detection sensor. See ["4.15 R32 leak detection sensor"](#) [▶ 173]. If operation time approaches 10 years, order a new R32 leak detection sensor and replace at the next maintenance interval.

Possible cause: R32 leak detection sensor operation time reached or approaches maximum value (10 years).

- 3 Perform a check of the R32 leak detection sensor of the faulty indoor unit. See ["4.15 R32 leak detection sensor"](#) [▶ 173].

Possible cause: Faulty R32 leak detection sensor.

- 4 Check if any external (foreign) vapor substance influenced the functioning of the R32 leak detection sensor. Repair as needed.

Possible cause: External (foreign) vapor substance reacted with R32 leak detection sensor.

- 5 Perform a check of the indoor unit main PCB. See ["4.9 Indoor unit main PCB"](#) [▶ 110].

Possible cause: Faulty indoor unit main PCB.

**INFORMATION**

If all procedures listed above have been performed and the problem is still present, contact the helpdesk.

3.5.10 E1-00 – Outdoor unit: PCB defect

Trigger	Effect	Reset
Main PCB detects that EEPROM is abnormal.	Unit will stop operating.	Manual reset via user interface.
		Power reset.

To solve the error code



INFORMATION

It is recommended to perform the checks in the listed order.

- 1 Perform a check of the main PCB. See "[4.12 Main PCB](#)" [▶ 129].
Possible cause: Faulty main PCB.
- 2 Check if the power supply is compliant with the regulations. See "[5.1 Electrical circuit](#)" [▶ 212].
Possible cause:
 - Faulty or disturbance of the power supply (power supply MUST be within range of nominal operating voltage $\pm 4\%$),
 - Power drop,
 - Short circuit.
- 3 Perform a check of the outdoor unit fan motor. See "[4.13 Outdoor unit fan motor](#)" [▶ 147].
Possible cause: Faulty outdoor unit fan motor.
- 4 Perform a check of the compressor. See "[4.2 Compressor](#)" [▶ 60].
Possible cause: Faulty compressor or miswiring of the compressor power supply cable.

Prerequisite: Stop the unit operation via the user interface.

Prerequisite: Turn OFF the respective circuit breaker.

- 5 Wait until the rectifier voltage is below 10 V DC.



DANGER: RISK OF ELECTROCUTION

Wait for at least 10 minutes after the circuit breaker has been turned OFF, to be sure the rectifier voltage is below 10 V DC before proceeding.

- 6 Check that the thermal interface grease is applied properly on the (PCB or refrigerant piping) contact surface of the heat sink. Adjust if needed.
Possible cause: Thermal interface grease NOT applied properly on the heat sink.



INFORMATION

If all procedures listed above have been performed and the problem is still present, contact the helpdesk.

3.5.11 E3-00 – Outdoor unit: Actuation of high pressure switch

Trigger	Effect	Reset
High pressure switch opens due to measured pressure above high pressure switch operating point.	Unit will stop operating.	Manual reset via user interface.
High pressure control (measured pressure just below high pressure switch operating point) occurs 16 times within 300 minutes.		

To solve the error code

**INFORMATION**

It is recommended to perform the checks in the listed order.

- 1 Check that all stop valves of the refrigerant circuit are open. See ["5.2 Refrigerant circuit" \[▶ 214\]](#).
Possible cause: Closed stop valve in the refrigerant circuit.
- 2 Perform a check of the high pressure switch. See ["4.6 High pressure switch" \[▶ 93\]](#).
Possible cause: Faulty high pressure switch.
- 3 Perform a check of the main PCB. See ["4.12 Main PCB" \[▶ 129\]](#).
Possible cause: Faulty main PCB.
- 4 Check if the refrigerant circuit is correctly charged. See ["5.2 Refrigerant circuit" \[▶ 214\]](#).
Possible cause: Refrigerant overcharge.
- 5 Check for the presence of non-condensables and/or humidity in the refrigerant circuit. See ["5.2 Refrigerant circuit" \[▶ 214\]](#).
Possible cause: Non-condensables and/or humidity in the refrigerant circuit.
- 6 Check if the refrigerant circuit is clogged. See ["5.2 Refrigerant circuit" \[▶ 214\]](#).
Possible cause: Clogged refrigerant circuit.
- 7 Perform a check of the outdoor unit fan motor. See ["4.13 Outdoor unit fan motor" \[▶ 147\]](#).
Possible cause: Faulty outdoor unit fan motor.

**INFORMATION**

If all procedures listed above have been performed and the problem is still present, contact the helpdesk.

3.5.12 E5-00 – Outdoor unit: Overheat of inverter compressor motor

Trigger	Effect	Reset
Compressor overload is detected.	Unit will NOT stop operating.	Automatic reset if the unit runs without warning for 60 seconds.

To solve the error code

**INFORMATION**

It is recommended to perform the checks in the listed order.

- 1 Check that all stop valves of the refrigerant circuit are open. See "[5.2 Refrigerant circuit](#)" [▶ 214].
Possible cause: Closed stop valve in the refrigerant circuit.
- 2 Perform a check of the discharge pipe thermistor. See "[4.20 Thermistors](#)" [▶ 199].
Possible cause: Faulty discharge pipe thermistor or connector fault.
- 3 Perform a check of the outdoor unit fan motor. See "[4.13 Outdoor unit fan motor](#)" [▶ 147].
Possible cause: Faulty outdoor unit fan motor.
- 4 Perform a check of the compressor. See "[4.2 Compressor](#)" [▶ 60].
Possible cause: Faulty compressor or miswiring of the compressor power supply cable.
- 5 Perform a check of the expansion valve. See "[4.5 Expansion valve](#)" [▶ 85].
Possible cause: Faulty expansion valve.
- 6 Perform a check of the 4-way valve. See "[4.1 4-way valve](#)" [▶ 52].
Possible cause: Faulty 4-way valve.
- 7 Perform a check of the main PCB. See "[4.12 Main PCB](#)" [▶ 129].
Possible cause: Faulty main PCB.
- 8 Check if the refrigerant circuit is correctly charged. See "[5.2 Refrigerant circuit](#)" [▶ 214].
Possible cause: Refrigerant shortage.
- 9 Check for the presence of non-condensables and/or humidity in the refrigerant circuit. See "[5.2 Refrigerant circuit](#)" [▶ 214].
Possible cause: Non-condensables and/or humidity in the refrigerant circuit.
- 10 Check if the refrigerant circuit is clogged. See "[5.2 Refrigerant circuit](#)" [▶ 214].
Possible cause: Clogged refrigerant circuit.

**INFORMATION**

If all procedures listed above have been performed and the problem is still present, contact the helpdesk.

3.5.13 E6-00 – Outdoor unit: Compressor startup defect

Trigger	Effect	Reset
The motor rotor does NOT rotate when the compressor is energized.	Unit will NOT stop operating.	Automatic reset after a continuous run for 10 minutes.
	Unit will stop operating	Manual reset via user interface.

To solve the error code

**INFORMATION**

It is recommended to perform the checks in the listed order.

- 1 Perform a check of the discharge pipe thermistor. See ["4.20 Thermistors"](#) [▶ 199].
Possible cause: Faulty discharge pipe thermistor or connector fault.
- 2 Check that all stop valves of the refrigerant circuit are open. See ["5.2 Refrigerant circuit"](#) [▶ 214].
Possible cause: Closed stop valve in the refrigerant circuit.
- 3 Check if the refrigerant circuit is clogged. See ["5.2 Refrigerant circuit"](#) [▶ 214].
Possible cause: Clogged refrigerant circuit.
- 4 Check if the refrigerant circuit is correctly charged. See ["5.2 Refrigerant circuit"](#) [▶ 214].
Possible cause: Refrigerant overcharge or shortage.
- 5 Check for the presence of non-condensables and/or humidity in the refrigerant circuit. See ["5.2 Refrigerant circuit"](#) [▶ 214].
Possible cause: Non-condensables and/or humidity in the refrigerant circuit.
- 6 Perform a check of the compressor. See ["4.2 Compressor"](#) [▶ 60].
Possible cause: Faulty compressor or miswiring of the compressor power supply cable.
- 7 Perform a check of the main PCB. See ["4.12 Main PCB"](#) [▶ 129].
Possible cause: Faulty main PCB.
- 8 Perform a check of the 4-way valve. See ["4.1 4-way valve"](#) [▶ 52].
Possible cause: Faulty 4-way valve.
- 9 Perform a check of the expansion valve. See ["4.5 Expansion valve"](#) [▶ 85].
Possible cause: Faulty expansion valve.

**INFORMATION**

If all procedures listed above have been performed and the problem is still present, contact the helpdesk.

3.5.14 E7-00 – Outdoor unit: Malfunction of outdoor unit fan motor

Trigger	Effect	Reset
<p>Fan does NOT start 15~30 seconds after ON signal.</p> <p>It can occur that the error code is triggered when the fan motor is running caused by a faulty rotating sensor signal.</p>	Unit will stop operating.	Manual reset via user interface.

To solve the error code

 **INFORMATION**
It is recommended to perform the checks in the listed order.

- 1 Perform a check of the outdoor unit fan motor. See "[4.13 Outdoor unit fan motor](#)" [▶ 147].
Possible cause: Faulty outdoor unit fan motor.
- 2 Perform a check of the main PCB. See "[4.12 Main PCB](#)" [▶ 129].
Possible cause: Faulty main PCB.

 **INFORMATION**
If all procedures listed above have been performed and the problem is still present, contact the helpdesk.

3.5.15 E8-00 – Outdoor unit: Power input overvoltage

Trigger	Effect	Reset
Compressor running current exceeds standard value for 2.5 seconds.	Unit will stop operating.	Manual reset via user interface.

To solve the error code

 **INFORMATION**
It is recommended to perform the checks in the listed order.

- 1 Check the outdoor temperature. See "[5.3 External factors](#)" [▶ 223].
Possible cause: Outdoor temperature is out of operation range.
- 2 Perform a check of the compressor. See "[4.2 Compressor](#)" [▶ 60].
Possible cause: Faulty compressor or miswiring of the compressor power supply cable.
- 3 Perform a check of the main PCB. See "[4.12 Main PCB](#)" [▶ 129].
Possible cause: Faulty main PCB.
- 4 Check if the power supply is compliant with the regulations. See "[5.1 Electrical circuit](#)" [▶ 212].

Possible cause:

- Faulty or disturbance of the power supply (power supply MUST be within range of nominal operating voltage $\pm 4\%$),
- Power drop,
- Short circuit.

**INFORMATION**

If all procedures listed above have been performed and the problem is still present, contact the helpdesk.

3.5.16 EA-00 – Outdoor unit: Cool/heat switchover problem

Trigger	Effect	Reset
Room thermistor is NOT functioning within operation range.	Unit will NOT stop operating.	Automatic reset after a continuous operation for some time.
	If the error occurs too soon: unit will stop operating.	Manual reset via user interface.

To solve the error code**INFORMATION**

It is recommended to perform the checks in the listed order.

- 1 Perform a check of the 4-way valve. See "[4.1 4-way valve](#)" [▶ 52].
Possible cause: Faulty 4-way valve.
- 2 Perform a check of the main PCB. See "[4.12 Main PCB](#)" [▶ 129].
Possible cause: Faulty main PCB.
- 3 Perform a check of the indoor unit air (room) thermistor. See "[4.20 Thermistors](#)" [▶ 199].
Possible cause: Faulty indoor unit air (room) thermistor.
- 4 Perform a check of the indoor unit main PCB. See "[4.9 Indoor unit main PCB](#)" [▶ 110].
Possible cause: Faulty indoor unit main PCB.
- 5 Check that all stop valves of the refrigerant circuit are open. See "[5.2 Refrigerant circuit](#)" [▶ 214].
Possible cause: Closed stop valve in the refrigerant circuit.
- 6 Check if the refrigerant circuit is clogged. See "[5.2 Refrigerant circuit](#)" [▶ 214].
Possible cause: Clogged refrigerant circuit.
- 7 Check if the refrigerant circuit is correctly charged. See "[5.2 Refrigerant circuit](#)" [▶ 214].
Possible cause: Refrigerant overcharge or shortage.
- 8 Check for the presence of non-condensables and/or humidity in the refrigerant circuit. See "[5.2 Refrigerant circuit](#)" [▶ 214].
Possible cause: Non-condensables and/or humidity in the refrigerant circuit.

**INFORMATION**

If all procedures listed above have been performed and the problem is still present, contact the helpdesk.

3.5.17 F3-00 – Outdoor unit: Malfunction of discharge pipe temperature

Trigger	Effect	Reset
Discharge pipe thermistor detects a too high temperature.	Unit will NOT stop operating.	Automatic reset when temperature drops normal level.
	If the error re-occurs too soon: unit will stop operating.	Manual reset via user interface.

To solve the error code**INFORMATION**

It is recommended to perform the checks in the listed order.

- 1 Check that all stop valves of the refrigerant circuit are open. See "[5.2 Refrigerant circuit](#)" [▶ 214].
Possible cause: Closed stop valve in the refrigerant circuit.
- 2 Check if the refrigerant circuit is correctly charged. See "[5.2 Refrigerant circuit](#)" [▶ 214].
Possible cause: Refrigerant overcharge or shortage.
- 3 Check for the presence of non-condensables and/or humidity in the refrigerant circuit. See "[5.2 Refrigerant circuit](#)" [▶ 214].
Possible cause: Non-condensables and/or humidity in the refrigerant circuit.
- 4 Check if the refrigerant circuit is clogged. See "[5.2 Refrigerant circuit](#)" [▶ 214].
Possible cause: Clogged refrigerant circuit.
- 5 Perform a check of the 4-way valve. See "[4.1 4-way valve](#)" [▶ 52].
Possible cause: Faulty 4-way valve.
- 6 Perform a check of the expansion valve. See "[4.5 Expansion valve](#)" [▶ 85].
Possible cause: Faulty expansion valve.
- 7 Perform a check of the main PCB. See "[4.12 Main PCB](#)" [▶ 129].
Possible cause: Faulty main PCB.
- 8 Perform a check of all refrigerant side thermistors. See "[4.20 Thermistors](#)" [▶ 199].
Possible cause: Faulty refrigerant side thermistor(s).

**INFORMATION**

If all procedures listed above have been performed and the problem is still present, contact the helpdesk.

3.5.18 F6-00 – Outdoor unit: Abnormal high pressure in cooling

Trigger	Effect	Reset
Outdoor heat exchanger thermistor measures a too high temperature.	Unit will NOT stop operating.	Automatic reset when temperature drops.

To solve the error code

**INFORMATION**

It is recommended to perform the checks in the listed order.

- 1 Clean the outdoor heat exchanger. See "[6 Maintenance](#)" [▶ 225].
Possible cause: Dirty outdoor heat exchanger.
- 2 Check that all stop valves of the refrigerant circuit are open. See "[5.2 Refrigerant circuit](#)" [▶ 214].
Possible cause: Closed stop valve in the refrigerant circuit.
- 3 Perform a check of the heat exchanger thermistor. See "[4.20 Thermistors](#)" [▶ 199].
Possible cause: Faulty heat exchanger thermistor.
- 4 Perform a check of the expansion valve. See "[4.5 Expansion valve](#)" [▶ 85].
Possible cause: Faulty expansion valve.
- 5 Perform a check of the main PCB. See "[4.12 Main PCB](#)" [▶ 129].
Possible cause: Faulty main PCB.
- 6 Check if the refrigerant circuit is correctly charged. See "[5.2 Refrigerant circuit](#)" [▶ 214].
Possible cause: Refrigerant overcharge.
- 7 Check for the presence of non-condensables and/or humidity in the refrigerant circuit. See "[5.2 Refrigerant circuit](#)" [▶ 214].
Possible cause: Non-condensables and/or humidity in the refrigerant circuit.
- 8 Check if the refrigerant circuit is clogged. See "[5.2 Refrigerant circuit](#)" [▶ 214].
Possible cause: Clogged refrigerant circuit.
- 9 Perform a check of the outdoor unit fan motor. See "[4.13 Outdoor unit fan motor](#)" [▶ 147].
Possible cause: Faulty outdoor unit fan motor.

**INFORMATION**

If all procedures listed above have been performed and the problem is still present, contact the helpdesk.

3.5.19 F8-00 – System shutdown due to compressor internal temperature abnormality

Trigger	Effect	Reset
Temperature discharge pipe thermistor exceeds the determined limit.	Unit will stop operating.	Manual reset via user interface.

To solve the error code



INFORMATION

It is recommended to perform the checks in the listed order.

- 1 Check that all stop valves of the refrigerant circuit are open. See "5.2 Refrigerant circuit" [▶ 214].
Possible cause: Closed stop valve in the refrigerant circuit.
- 2 Check if the refrigerant circuit is correctly charged. See "5.2 Refrigerant circuit" [▶ 214].
Possible cause: Refrigerant overcharge.
- 3 Check for the presence of non-condensables and/or humidity in the refrigerant circuit. See "5.2 Refrigerant circuit" [▶ 214].
Possible cause: Non-condensables and/or humidity in the refrigerant circuit.
- 4 Check if the refrigerant circuit is clogged. See "5.2 Refrigerant circuit" [▶ 214].
Possible cause: Clogged refrigerant circuit.
- 5 Perform a check of the discharge pipe thermistor. See "4.20 Thermistors" [▶ 199].
Possible cause: Faulty discharge pipe thermistor or connector fault.



INFORMATION

If all procedures listed above have been performed and the problem is still present, contact the helpdesk.

3.5.20 H0-00 – Outdoor unit: Voltage/current sensor problem

Trigger	Effect	Reset
Compressor voltage (DC) is out of range before start-up.	Unit will stop operating.	Manual reset via user interface.

To solve the error code



INFORMATION

It is recommended to perform the checks in the listed order.

- 1 Perform a check of the main PCB. See "4.12 Main PCB" [▶ 129].
Possible cause: Faulty main PCB.
- 2 Check if the power supply is compliant with the regulations. See "5.1 Electrical circuit" [▶ 212].
Possible cause:
 - Faulty or disturbance of the power supply (power supply MUST be within range of nominal operating voltage $\pm 4\%$),
 - Power drop,
 - Short circuit.

Prerequisite: Stop the unit operation via the user interface.

Prerequisite: Turn OFF the respective circuit breaker.

- 3 Wait until the rectifier voltage is below 10 V DC.



DANGER: RISK OF ELECTROCUTION

Wait for at least 10 minutes after the circuit breaker has been turned OFF, to be sure the rectifier voltage is below 10 V DC before proceeding.

- 4 Check that the thermal interface grease is applied properly on the (PCB or refrigerant piping) contact surface of the heat sink. Adjust if needed.

Possible cause: Thermal interface grease NOT applied properly on the heat sink.



INFORMATION

If all procedures listed above have been performed and the problem is still present, contact the helpdesk.

3.5.21 H3-00 – Outdoor unit: Malfunction of high pressure switch

Trigger	Effect	Reset
High pressure switch is activated when compressor is off.	Unit will stop operating.	Manual reset via user interface.

To solve the error code



INFORMATION

It is recommended to perform the checks in the listed order.

- 1 Perform a check of the high pressure switch. See "[4.6 High pressure switch](#)" [▶ 93].

Possible cause: Faulty high pressure switch.

- 2 Perform a check of the main PCB. See "[4.12 Main PCB](#)" [▶ 129].

Possible cause: Faulty main PCB.

- 3 Check if the power supply is compliant with the regulations. See "[5.1 Electrical circuit](#)" [▶ 212].

Possible cause:

- Faulty or disturbance of the power supply (power supply MUST be within range of nominal operating voltage $\pm 4\%$),
- Power drop,
- Short circuit.



INFORMATION

If all procedures listed above have been performed and the problem is still present, contact the helpdesk.

3.5.22 H6-00 – Outdoor unit: Malfunction of position detection sensor

Trigger	Effect	Reset
Compressor fails to start within 15 seconds after the compressor run command signal is sent.	Unit will NOT stop operating.	Automatic reset after a continuous operation of 10 minutes.
	If the error re-occurs within 8 minutes: unit will stop operating.	Manual reset via user interface.

To solve the error code

**INFORMATION**

It is recommended to perform the checks in the listed order.

- 1 Perform a check of the compressor. See "[4.2 Compressor](#)" [▶ 60].
Possible cause: Faulty compressor or miswiring of the compressor power supply cable.
- 2 Perform a check of the main PCB. See "[4.12 Main PCB](#)" [▶ 129].
Possible cause: Faulty main PCB.
- 3 Check that all stop valves of the refrigerant circuit are open. See "[5.2 Refrigerant circuit](#)" [▶ 214].
Possible cause: Closed stop valve in the refrigerant circuit.
- 4 Check if the refrigerant circuit is clogged. See "[5.2 Refrigerant circuit](#)" [▶ 214].
Possible cause: Clogged refrigerant circuit.
- 5 Check if the refrigerant circuit is correctly charged. See "[5.2 Refrigerant circuit](#)" [▶ 214].
Possible cause: Refrigerant overcharge or shortage.
- 6 Check for the presence of non-condensables and/or humidity in the refrigerant circuit. See "[5.2 Refrigerant circuit](#)" [▶ 214].
Possible cause: Non-condensables and/or humidity in the refrigerant circuit.
- 7 Check if the power supply is compliant with the regulations. See "[5.1 Electrical circuit](#)" [▶ 212].
Possible cause:
 - Faulty or disturbance of the power supply (power supply MUST be within range of nominal operating voltage $\pm 4\%$),
 - Power drop,
 - Short circuit.

**INFORMATION**

If all procedures listed above have been performed and the problem is still present, contact the helpdesk.

3.5.23 H8-00 – Outdoor unit: Malfunction of compressor input system

Trigger	Effect	Reset
DC voltage or current sensor abnormality based on the compressor running frequency and the input current.	Unit will NOT stop operating.	Automatic reset when compressor runs normally for 60 minutes.
	If the error re-occurs too soon: unit will stop operating.	Manual reset via user interface.

To solve the error code**INFORMATION**

It is recommended to perform the checks in the listed order.

- 1 Perform a check of the main PCB. See "[4.12 Main PCB](#)" [▶ 129].
Possible cause: Faulty main PCB.
- 2 Perform a check of the compressor. See "[4.2 Compressor](#)" [▶ 60].
Possible cause: Faulty compressor or miswiring of the compressor power supply cable.
- 3 Perform a check of the reactor. See "[4.16 Reactor](#)" [▶ 176].
Possible cause: Faulty reactor.

**INFORMATION**

If all procedures listed above have been performed and the problem is still present, contact the helpdesk.

3.5.24 H9-00 – Outdoor unit: Malfunction of outdoor air thermistor

Trigger	Effect	Reset
Outdoor air thermistor input is out of range.	Unit will stop operating.	Manual reset via user interface.

To solve the error code**INFORMATION**

It is recommended to perform the checks in the listed order.

- 1 Perform a check of the outdoor air thermistor. See "[4.20 Thermistors](#)" [▶ 199].
Possible cause: Faulty ambient air thermistor.
- 2 Perform a check of the main PCB. See "[4.12 Main PCB](#)" [▶ 129].
Possible cause: Faulty main PCB.

**INFORMATION**

If all procedures listed above have been performed and the problem is still present, contact the helpdesk.

3.5.25 J3-00 – Outdoor unit: Malfunction of discharge pipe thermistor

Trigger	Effect	Reset
Discharge pipe thermistor input is out of range.	Unit will stop operating.	Manual reset via user interface.

To solve the error code



INFORMATION

It is recommended to perform the checks in the listed order.

- 1 Perform a check of the discharge pipe thermistor. See "[4.20 Thermistors](#)" [▶ 199].

Possible cause: Faulty discharge pipe thermistor or connector fault.

- 2 Perform a check of the main PCB. See "[4.12 Main PCB](#)" [▶ 129].

Possible cause: Faulty main PCB.



INFORMATION

If all procedures listed above have been performed and the problem is still present, contact the helpdesk.

3.5.26 J6-00 – Outdoor unit: Malfunction of heat exchanger thermistor

Trigger	Effect	Reset
Outdoor heat exchanger thermistor input is out of range.	Unit will stop operating.	Manual reset via user interface.

To solve the error code



INFORMATION

It is recommended to perform the checks in the listed order.

- 1 Perform a check of the heat exchanger thermistor. See "[4.20 Thermistors](#)" [▶ 199].

Possible cause: Faulty heat exchanger thermistor.

- 2 Perform a check of the main PCB. See "[4.12 Main PCB](#)" [▶ 129].

Possible cause: Faulty main PCB.



INFORMATION

If all procedures listed above have been performed and the problem is still present, contact the helpdesk.

3.5.27 L3-00 – Outdoor unit: Electrical box temperature rise problem

Trigger	Effect	Reset
Switch box temperature is too high.	Unit will stop operating.	Manual reset via remote controller.

To solve the error code



INFORMATION

It is recommended to perform the checks in the listed order.

- 1 Perform a check of the main PCB. See ["4.12 Main PCB"](#) [▶ 129].
Possible cause: Faulty main PCB.
- 2 Perform a check of the outdoor unit fan motor. See ["4.13 Outdoor unit fan motor"](#) [▶ 147].
Possible cause: Faulty outdoor unit fan motor.
- 3 Check if the power supply is compliant with the regulations. See ["5.1 Electrical circuit"](#) [▶ 212].
Possible cause:
 - Faulty or disturbance of the power supply (power supply MUST be within range of nominal operating voltage $\pm 4\%$),
 - Power drop,
 - Short circuit.
- 4 Clean the outdoor heat exchanger. See ["6 Maintenance"](#) [▶ 225].
Possible cause: Dirty outdoor heat exchanger.



INFORMATION

If all procedures listed above have been performed and the problem is still present, contact the helpdesk.

3.5.28 L4-00 – Outdoor unit: Malfunction of inverter radiating fin temperature rise

Trigger	Effect	Reset
Radiating fin thermistor measures a too high temperature.	Unit will stop operating.	Manual reset via user interface.

To solve the error code



INFORMATION

It is recommended to perform the checks in the listed order.

- 1 Perform a check of the outdoor unit fan motor. See ["4.13 Outdoor unit fan motor"](#) [▶ 147].
Possible cause: Faulty outdoor unit fan motor.
- 2 Check if the power supply is compliant with the regulations. See ["5.1 Electrical circuit"](#) [▶ 212].
Possible cause:
 - Faulty or disturbance of the power supply (power supply MUST be within range of nominal operating voltage $\pm 4\%$),
 - Power drop,
 - Short circuit.
- 3 Perform a check of the main PCB. See ["4.12 Main PCB"](#) [▶ 129].
Possible cause: Faulty main PCB.

Prerequisite: Stop the unit operation via the user interface.

Prerequisite: Turn OFF the respective circuit breaker.

- 4 Wait until the rectifier voltage is below 10 V DC.



DANGER: RISK OF ELECTROCUTION

Wait for at least 10 minutes after the circuit breaker has been turned OFF, to be sure the rectifier voltage is below 10 V DC before proceeding.

- 5 Check that the thermal interface grease is applied properly on the (PCB or refrigerant piping) contact surface of the heat sink. Adjust if needed.

Possible cause: Thermal interface grease NOT applied properly on the heat sink.



INFORMATION

If all procedures listed above have been performed and the problem is still present, contact the helpdesk.

3.5.29 L5-00 – Outdoor unit: Inverter instantaneous overcurrent

Trigger	Effect	Reset
An output overcurrent is detected by checking the current that flows in the inverter DC section.	Unit will stop operating.	Manual reset via user interface.

To solve the error code



INFORMATION

It is recommended to perform the checks in the listed order.

- 1 Check that all stop valves of the refrigerant circuit are open. See "[5.2 Refrigerant circuit](#)" [▶ 214].
Possible cause: Closed stop valve in the refrigerant circuit.
- 2 Check if the refrigerant circuit is clogged. See "[5.2 Refrigerant circuit](#)" [▶ 214].
Possible cause: Clogged refrigerant circuit.
- 3 Check if the refrigerant circuit is correctly charged. See "[5.2 Refrigerant circuit](#)" [▶ 214].
Possible cause: Refrigerant overcharge or shortage.
- 4 Check for the presence of non-condensables and/or humidity in the refrigerant circuit. See "[5.2 Refrigerant circuit](#)" [▶ 214].
Possible cause: Non-condensables and/or humidity in the refrigerant circuit.
- 5 Perform a check of the main PCB. See "[4.12 Main PCB](#)" [▶ 129].
Possible cause: Faulty main PCB.
- 6 Perform a check of the compressor. See "[4.2 Compressor](#)" [▶ 60].
Possible cause: Faulty compressor or miswiring of the compressor power supply cable.
- 7 Check if the power supply is compliant with the regulations. See "[5.1 Electrical circuit](#)" [▶ 212].

Possible cause:

- Faulty or disturbance of the power supply (power supply MUST be within range of nominal operating voltage $\pm 4\%$),
- Power drop,
- Short circuit.

Prerequisite: Stop the unit operation via the user interface.

Prerequisite: Turn OFF the respective circuit breaker.

- 8 Wait until the rectifier voltage is below 10 V DC.

**DANGER: RISK OF ELECTROCUTION**

Wait for at least 10 minutes after the circuit breaker has been turned OFF, to be sure the rectifier voltage is below 10 V DC before proceeding.

- 9 Check that the thermal interface grease is applied properly on the (PCB or refrigerant piping) contact surface of the heat sink. Adjust if needed.

Possible cause: Thermal interface grease NOT applied properly on the heat sink.

**INFORMATION**

If all procedures listed above have been performed and the problem is still present, contact the helpdesk.

3.5.30 P4-00 – Outdoor unit: Malfunction of radiating fin temperature sensor

Trigger	Effect	Reset
Radiating fin thermistor input is out of range.	Unit will stop operating.	Manual reset via user interface.

To solve the error code**INFORMATION**

It is recommended to perform the checks in the listed order.

- 1 Perform a check of the main PCB. See "[4.12 Main PCB](#)" [▶ 129].

Possible cause: Faulty main PCB.

**INFORMATION**

If all procedures listed above have been performed and the problem is still present, contact the helpdesk.

3.5.31 U0-00 – Outdoor unit: Shortage of refrigerant

Trigger	Effect	Reset
Refrigerant shortage detected.	Unit will stop operating.	Automatic reset.
		Power reset via outdoor unit.

To solve the error code



INFORMATION

It is recommended to perform the checks in the listed order.

- 1 Perform a check of all refrigerant side thermistors. See ["4.20 Thermistors"](#) [▶ 199].
Possible cause: Faulty refrigerant side thermistor(s).
- 2 Check that all stop valves of the refrigerant circuit are open. See ["5.2 Refrigerant circuit"](#) [▶ 214].
Possible cause: Closed stop valve in the refrigerant circuit.
- 3 Check if the refrigerant circuit is clogged. See ["5.2 Refrigerant circuit"](#) [▶ 214].
Possible cause: Clogged refrigerant circuit.
- 4 Check if the refrigerant circuit is correctly charged. See ["5.2 Refrigerant circuit"](#) [▶ 214].
Possible cause: Refrigerant shortage.
- 5 Check for the presence of non-condensables and/or humidity in the refrigerant circuit. See ["5.2 Refrigerant circuit"](#) [▶ 214].
Possible cause: Non-condensables and/or humidity in the refrigerant circuit.
- 6 Perform a check of the compressor. See ["4.2 Compressor"](#) [▶ 60].
Possible cause: Faulty compressor or miswiring of the compressor power supply cable.
- 7 Perform a check of the expansion valve. See ["4.5 Expansion valve"](#) [▶ 85].
Possible cause: Faulty expansion valve.
- 8 Check for leaks in the refrigerant circuit. Look for oil traces on the unit(s). Check the brazing points on the field piping. Perform a pressure test, see ["5.2 Refrigerant circuit"](#) [▶ 214].
Possible cause: Leak in the refrigerant circuit.



INFORMATION

If all procedures listed above have been performed and the problem is still present, contact the helpdesk.

3.5.32 U2-00 – Outdoor unit: Defect of power supply voltage

Trigger	Effect	Reset
Power supply abnormality or instant power failure is detected.	Unit will stop operating.	Power reset via outdoor unit.

To solve the error code



INFORMATION

It is recommended to perform the checks in the listed order.

- 1 Check if the power supply is compliant with the regulations. See ["5.1 Electrical circuit"](#) [▶ 212].

- Possible cause:**
- Faulty or disturbance of the power supply (power supply MUST be within range of nominal operating voltage $\pm 4\%$),
 - Power drop,
 - Short circuit.
- 2 Perform a check of the compressor. See "[4.2 Compressor](#)" [▶ 60].
- Possible cause:** Faulty compressor or miswiring of the compressor power supply cable.
- 3 Perform a check of the outdoor unit fan motor. See "[4.13 Outdoor unit fan motor](#)" [▶ 147].
- Possible cause:** Faulty outdoor unit fan motor.
- 4 Perform a check of the main PCB. See "[4.12 Main PCB](#)" [▶ 129].
- Possible cause:** Faulty main PCB.
- 5 Wait until the compressor restarts.
- Possible cause:**
- Momentary drop of voltage,
 - Momentary power failure.
- 6 Perform a check of the indoor unit main PCB. See "[4.9 Indoor unit main PCB](#)" [▶ 110].
- Possible cause:** Faulty indoor unit main PCB.
- 7 Perform a check of the indoor unit power PCB. See "[4.10 Indoor unit power PCB](#)" [▶ 116].
- Possible cause:** Faulty indoor unit power PCB.

**INFORMATION**

If all procedures listed above have been performed and the problem is still present, contact the helpdesk.

3.5.33 U4-00 – Indoor/outdoor unit communication problem

Trigger	Effect	Reset
Communication failure between outdoor and indoor unit.	Unit will stop operating.	Power reset via outdoor unit.

To solve the error code**INFORMATION**

It is recommended to perform the checks in the listed order.

- 1 Check if the power supply is compliant with the regulations. See "[5.1 Electrical circuit](#)" [▶ 212].
- Possible cause:**
- Faulty or disturbance of the power supply (power supply MUST be within range of nominal operating voltage $\pm 4\%$),
 - Power drop,
 - Short circuit.

- 2 Perform a check of the power supply, connections, wiring,... between the outdoor unit and the indoor unit. See "5.1 Electrical circuit" [▶ 212].
Possible cause: Faulty wiring between the outdoor unit and the indoor unit.
- 3 Perform a check of the main PCB. See "4.12 Main PCB" [▶ 129].
Possible cause: Faulty main PCB.
- 4 Perform a check of the outdoor unit fan motor. See "4.13 Outdoor unit fan motor" [▶ 147].
Possible cause: Faulty outdoor unit fan motor.
- 5 Perform a check of the indoor unit main PCB. See "4.9 Indoor unit main PCB" [▶ 110].
Possible cause: Faulty indoor unit main PCB.
- 6 Perform a check of the indoor unit power PCB. See "4.10 Indoor unit power PCB" [▶ 116].
Possible cause: Faulty indoor unit power PCB.

Prerequisite: Stop the unit operation via the user interface.

Prerequisite: Turn OFF the respective circuit breaker.

- 7 Wait until the rectifier voltage is below 10 V DC.



DANGER: RISK OF ELECTROCUTION

Wait for at least 10 minutes after the circuit breaker has been turned OFF, to be sure the rectifier voltage is below 10 V DC before proceeding.

- 8 Check that the thermal interface grease is applied properly on the (PCB or refrigerant piping) contact surface of the heat sink. Adjust if needed.
Possible cause: Thermal interface grease NOT applied properly on the heat sink.



INFORMATION

If all procedures listed above have been performed and the problem is still present, contact the helpdesk.

3.5.34 UA-00 – Indoor unit, outdoor unit mismatching problem

Trigger	Effect	Reset
Signal transmission between outdoor and indoor unit abnormality. Improper combination of outdoor and indoor unit.	Unit will stop operating.	Power reset via outdoor unit.

To solve the error code



INFORMATION

It is recommended to perform the checks in the listed order.

- 1 Check for improper combination of the indoor unit and the outdoor unit. See the combination table in the Databook for more information.

- 2 Perform a check of the power supply, connections, wiring,... between the outdoor unit and the indoor unit. See "[5.1 Electrical circuit](#)" [▶ 212].
Possible cause: Faulty wiring between the outdoor unit and the indoor unit.
- 3 Perform a check of the main PCB. See "[4.12 Main PCB](#)" [▶ 129].
Possible cause: Faulty main PCB.
- 4 Perform a check of the indoor unit main PCB. See "[4.9 Indoor unit main PCB](#)" [▶ 110].
Possible cause: Faulty indoor unit main PCB.
- 5 Perform a check of the indoor unit power PCB. See "[4.10 Indoor unit power PCB](#)" [▶ 116].
Possible cause: Faulty indoor unit power PCB.

**INFORMATION**

If all procedures listed above have been performed and the problem is still present, contact the helpdesk.

3.5.35 UH-00 – Malfunction of system

Trigger	Effect	Reset
In case of connection with multi indoor units, when error UA, U0 or A5 occurs in other indoor unit.	Unit will stop operating.	Auto reset.

To solve the error code**INFORMATION**

It is recommended to perform the checks in the listed order.

- 1 Check all other indoor units for the following error codes. If found, see "[3.5 Error based troubleshooting](#)" [▶ 18] to solve the specific error.
 - A5-00 – Outdoor unit: High pressure peak cut / freeze protection problem
 - U0-00 – Outdoor unit: Shortage of refrigerant
 - UA-00 – Indoor unit, outdoor unit mismatching problem
Possible cause: Error on other indoor unit.
- 2 Perform a check of the indoor unit main PCB. See "[4.9 Indoor unit main PCB](#)" [▶ 110].
Possible cause: Faulty indoor unit main PCB.

**INFORMATION**

If all procedures listed above have been performed and the problem is still present, contact the helpdesk.

3.6 Symptom based troubleshooting

3.6.1 Operation does not start

Check	Detail
When the operation lamp is off, there is a power failure. Check the power supply.	<ul style="list-style-type: none"> ▪ Is the power supply breaker ON? ▪ Do other electrical appliances work? ▪ Is the rated voltage ($\pm 10\%$) supplied? ▪ Check the insulation of the electric system.
Check the type of the indoor unit.	Is the indoor unit type compatible with the outdoor unit?
Check the transmission between indoor and outdoor.	<ul style="list-style-type: none"> ▪ Connection wires.
Check the outdoor temperature.	<ul style="list-style-type: none"> ▪ Heating operation cannot be used when the outdoor temperature is 18°C WB or higher. ▪ Cooling operation cannot be used when the outdoor temperature is below -10°C DB.
When the operation lamp blinks, there may be an error code, activating the protection device. Diagnose with remote controller indication.	See " 3.5 Error based troubleshooting " [▶ 18].
Check the remote controller addresses.	Are the address settings for the remote controller and indoor unit correct?
Check the operation circuit.	<ul style="list-style-type: none"> ▪ Is the thermal fuse blown. ▪ Are wire size and wire connections OK?
Check fan motor.	<ul style="list-style-type: none"> ▪ Is the magnetic switch defective? ▪ Is the overcurrent relay defective?
Check compressor.	<ul style="list-style-type: none"> ▪ Is the contact defective? ▪ Is the protection thermostat defective? ▪ Is the compressor itself defective?
Check remote controller.	<ul style="list-style-type: none"> ▪ Are the batteries LOW? ▪ Are there incorrect settings?

3.6.2 Operation sometimes stops

Check	Detail
When the operation lamp is off, there is a power failure. Check the power supply.	<ul style="list-style-type: none"> ▪ A power failure of 2 to 10 cycles stops air conditioner operation.

Check	Detail
Check the outdoor temperature.	<ul style="list-style-type: none"> ▪ Heating operation cannot be used when the outdoor temperature is 18°C WB or higher. ▪ Cooling operation cannot be used when the outdoor temperature is below -10°C DB.
When the operation lamp blinks, there may be an error code, activating the protection device. Diagnose with remote controller indication.	See "3.5 Error based troubleshooting" [▶ 18].

3.6.3 Operation starts but the unit does not cool/heat

Check	Detail
Check the electrical power supply.	Is the rated voltage ($\pm 10\%$) supplied?
Check for piping and wiring errors in the connection between the indoor unit and outdoor unit.	<ul style="list-style-type: none"> ▪ Refrigerant piping is too long; is the length within specified range? ▪ Field piping is defective; is there a refrigerant leakage? ▪ Is there capacity loss over the condensor, saturation pressure or sound because of air mixed in to the circuit? ▪ Incorrect size of connection wiring.
When the operation lamp blinks, there may be a thermistor detection error code, activating the protection device.	<ul style="list-style-type: none"> ▪ Check the resistance of all thermistors. ▪ Check the connection of all thermistors. ▪ Is there a malfunction in the room temperature thermistor or outdoor temperature thermistor?
Check for faulty operation of the electronic expansion valve.	Set the unit to cooling operation, and check the temperature of the liquid pipe to see if the electronic expansion valve works.
Diagnose by service port pressure and operating current.	Check for refrigerant shortage.
Check if the set temperature is appropriate.	thermostat "off" can be activated, set the appropriate temperature.
Check the type of the indoor and outdoor units.	Is the indoor unit type compatible with the outdoor unit?
Check the air filter.	Is the air filter clean?

Check	Detail
Check the installation conditions (specified in the installation manual).	<ul style="list-style-type: none"> ▪ Does the installed model has sufficient capacity? ▪ Is there a short circuit air flow caused by insufficient installation space?
Check the outdoor temperature.	<ul style="list-style-type: none"> ▪ Heating operation cannot be used when the outdoor temperature is 18°C WB or higher. ▪ Cooling operation cannot be used when the outdoor temperature is below -10°C DB.

3.6.4 Operating noise and vibrations

Check	Detail
Check the installation conditions (specified in the installation manual).	<ul style="list-style-type: none"> ▪ Use general vibration prevention where needed. ▪ If the mounting wall is too thin, you must use cushion material or rubber, or change the installation place. ▪ Refrigerant piping is too short; is the length within specified range? ▪ Due to bad installation or general conditions there may be deformation of the unit. ▪ Are all the screws installed and tightened properly? ▪ Is all piping secured, fixed and supported by inserting a cushion material where needed? ▪ Install piping weights or correct by hand if any piping is in contact with other parts. ▪ Is the fan in contact with other parts? If so separate the fan from the other parts.
Check refrigerant charge.	<ul style="list-style-type: none"> ▪ Is the unit filled with the specified refrigerant volume? ▪ Is there a flushing noise, due to refrigerant shortage? ▪ Is there air in the system?
Check the expansion valve.	If a passing sound is heard from the pressure reducing valve, apply sound insulation sheets of putty to reduce the valve noise.

3.6.5 Abnormal high pressure

In cooling mode

Check item	Detail
Does the outdoor unit fan run normally?	Visual inspection
Is the outdoor unit heat exchanger clogged?	Visual inspection
Is there clogging before or after the expansion valve (capillary)?	<ul style="list-style-type: none"> ▪ Check if there is a temperature difference before and after expansion valve (capillary). ▪ Check if the main valve unit of expansion valve operates (by noise, vibration).
Is the High Pressure Switch normal?	Check continuity by using a tester.
Is the outdoor unit installed under such conditions that short circuit easily occurs?	Visual inspection
Is the piping length ≤ 5 m?	Visual inspection
Does air enter the refrigerant system?	Conduct refrigerant collection and vacuum drying, and then add proper amount refrigerant.
Is the refrigerant overcharged?	Conduct refrigerant collection and vacuum drying, and then add proper amount refrigerant.

In heating mode

Check item	Detail
Does the indoor unit fan run normally?	Visual inspection
Is the indoor unit heat exchanger clogged?	Visual inspection
Is the indoor unit installed under such conditions that short circuit easily occurs?	Visual inspection
Is there clogging before or after the expansion valve (capillary)?	<ul style="list-style-type: none"> ▪ Check if there is a temperature difference before and after expansion valve (capillary). ▪ Check if the main valve unit of expansion valve operates (by noise, vibration).
Is the High Pressure Switch normal?	Check continuity by using a tester.
Is the minimum piping length respected?	Visual inspection
Does air enter the refrigerant system?	Conduct refrigerant collection and vacuum drying, and then add proper amount refrigerant.

Check item	Detail
Is the refrigerant overcharged?	Conduct refrigerant collection and vacuum drying, and then add proper amount refrigerant.

3.6.6 Abnormal low pressure

Abnormally low pressure level is mostly caused by the evaporator side. The following contents are provided based on field checking of service engineer. Further, the number is listed in the order of degree of influence.

In cooling mode

Check item	Detail
Does the indoor unit fan run normally?	Visual inspection
Is the indoor unit heat exchanger clogged?	Visual inspection
Is the indoor unit installed under such conditions that short circuit easily occurs?	Visual inspection
Is there clogging before or after the expansion valve (capillary)?	<ul style="list-style-type: none"> ▪ Check if there is a temperature difference before and after expansion valve (capillary). ▪ Check if the main valve unit of expansion valve operates (by noise, vibration).
Is the check valve (if applicable) clogged?	Check if there is a temperature difference before and after check valve. If YES, the check valve is clogged.
Is there a shortage of refrigerant?	Conduct refrigerant collection and vacuum drying, and then add proper amount refrigerant.

In heating mode

Check item	Detail
Does the outdoor unit fan run normally?	Visual inspection
Is the outdoor unit heat exchanger clogged?	Visual inspection
Is there clogging before or after the expansion valve (capillary)?	<ul style="list-style-type: none"> ▪ Check if there is a temperature difference before and after expansion valve (capillary). ▪ Check if the main valve unit of expansion valve operates (by noise, vibration).
Is the check valve (if applicable) clogged?	Check if there is a temperature difference before and after check valve. If YES, the check valve is clogged.

Check item	Detail
Is the outdoor unit installed under such conditions that short circuit easily occurs?	Visual inspection
Is there a shortage of refrigerant?	Conduct refrigerant collection and vacuum drying, and then add proper amount refrigerant.

3.6.7 Indoor fan starts operating but the compressor does not operate

Check	Detail
Check the power supply.	<ul style="list-style-type: none"> ▪ Is the rated voltage ($\pm 10\%$) supplied? ▪ Check the insulation of the electric system.
Check the thermistor.	<ul style="list-style-type: none"> ▪ Connection with PCB. ▪ Output.
Check PCB's HAP LED's (if applicable).	<ul style="list-style-type: none"> ▪ if green led on the control PCB is not blinking, then the microprocessor is not working. ▪ if the green led on the main PCB is not blinking, then the microprocessor is not working. ▪ if first green LED on the service monitor PCB is not blinking, then the microprocessor is not working.
Check the magnetic switch.	
Check the power transistor.	
Check the compressor.	<ul style="list-style-type: none"> ▪ Defective contact. ▪ Defective compressor. ▪ Defective protection thermostat.
Check the outdoor temperature.	<ul style="list-style-type: none"> ▪ Heating operation cannot be used when the outdoor temperature is 18°C WB or higher. ▪ Cooling operation cannot be used when the outdoor temperature is below -10°C DB.

3.6.8 Operation starts and the unit stops immediately

Check	Detail
Check the power supply.	<ul style="list-style-type: none"> ▪ Is the capacity of the safety breaker as specified? ▪ If the earth leakage breaker is too sensitive, then increase the set value of the earth leakage current of the breaker or replace the breaker. ▪ Is the circuit exclusive? ▪ Is the rated voltage ($\pm 10\%$) supplied? ▪ Is there an incorrect size of connection wiring?
Check the refrigerant charge.	<ul style="list-style-type: none"> ▪ Overcharge. ▪ Air in the system. ▪ Water in the system.
Check the fan motor.	<ul style="list-style-type: none"> ▪ Check the magnetic switch. ▪ Check the overcurrent relay.
Check the four way valve coil.	<ul style="list-style-type: none"> ▪ Is there a short circuit? ▪ Is the four way valve coil broken?
Check the outdoor PCB.	<ul style="list-style-type: none"> ▪ Is there a short circuit? ▪ Is the outdoor PCB broken?
Check the heat exchanger.	Soiled heat exchanger, obstruction.
Check the airflow.	Soiled air filter, obstruction, installation space.

3.6.9 Operation stops, unit cannot start for a while

Check	Detail
Check if standby function is activated.	<ul style="list-style-type: none"> ▪ Compressor delay timer is counting. ▪ Wait for minimum 3 minutes.
Check the power supply.	<ul style="list-style-type: none"> ▪ Low voltage? ▪ Is the size of the power cable sufficient?
Check the refrigerant charge.	<ul style="list-style-type: none"> ▪ Incorrect charge. ▪ Air in the system. ▪ Water in the system. ▪ Obstruction in the system.
Check compressor.	<ul style="list-style-type: none"> ▪ Overcurrent relay. ▪ Protection thermostat.

3.6.10 Unit discharges white mist

Check	Detail
Check installation conditions.	<ul style="list-style-type: none"> ▪ Humid site. ▪ Dirty site. ▪ Oil mist.
Check installation conditions.	Dirty heat exchanger.
Air filter.	Dirty air filter.
Fan motor.	Defective fan motor.

3.6.11 Humidifying problem

Check	Detail
Check the installation conditions.	<ul style="list-style-type: none"> ▪ Insufficient heat insulation of duct. ▪ Ceiling too high for the floor size. ▪ Short circuit air flow caused by insufficient installation space.
Check the installation.	<ul style="list-style-type: none"> ▪ Is the proper humidification hose, specified by Daikin, used? ▪ Breakage or blockage of the humidification hose. ▪ Is the length of the humidification hose correct (within specified length)? ▪ Is setting correct for the humidification hose length?
Check the outdoor temperature and humidity.	In case of extremely low outdoor temperature or extremely low humidity, the air outlet must be set at the height of 1,8m.
Check the temperature setting.	Is the set temperature too high?
Check the ventilation timing.	Is the room ventilated too often?
Check the air filter.	Is the air filter clogged?

3.6.12 Swing flap does not operate

Symptom	Check	Detail
Swing flap does not operate	Check swing flap motor	Some functions can force the swing flap into a fixed position, although swing mode is selected on the remote controller. This is not a unit error, but a control function to prevent draft to the customer.
	Check indoor unit PCB	Connector connection

4 Components



CAUTION

When replacing a component ALWAYS make sure the correct spare part for your unit is installed.

4.1 4-way valve

4.1.1 Checking procedures



INFORMATION

It is recommended to perform the checks in the listed order.

To perform a mechanical check of the 4-way valve

Prerequisite: Stop the unit operation via the user interface.

Prerequisite: Turn OFF the respective circuit breaker.

- 1 Remove the required plate work, see ["4.14 Plate work"](#) [▶ 157].



DANGER: RISK OF BURNING/SCALDING

The coil gets hot while energized. Wait for it to cool down.

- 2 Verify that the screw is firmly fixing the coil to the valve body.
- 3 Check if any damage or burst is present.

Is the 4-way valve coil firmly fixed and not visually damaged?	Action
Yes	Perform an electrical check of the 4-way valve, see "4.1.1 Checking procedures" [▶ 52].
No	Fix or replace the 4-way valve coil, see "4.1.2 Repair procedures" [▶ 56].

To perform an electrical check of the 4-way valve

- 1 First perform a mechanical check of the 4-way valve, see ["4.1.1 Checking procedures"](#) [▶ 52].
- 2 Unplug the 4-way valve connector from the appropriate PCB.
- 3 Measure the resistance of the 4-way valve coil between the pins of the 4-way valve connector.

Result: The measured value must be:

Class	Resistance
Class 20~35	560 Ω ± 5%
Class 42~60 + ARXM71R	1400 Ω ± 10%
RXM71R	1787 Ω ± 10%

Is the measured value correct?	Action
Yes	Continue with the next step.

Is the measured value correct?	Action
No	Replace the 4-way valve coil, see "4.1.2 Repair procedures" [▶ 56].

When outdoor temperature is mild and unit can switch between heating and cooling



INFORMATION

This procedure is ONLY possible when the outdoor temperature is within the temperature range for both **Heating** and **Cooling** operation mode. See the databook on Business Portal for the temperature range of the operation modes.

- 1 Connect the 4-way valve connector to the appropriate PCB.
- 2 Turn ON the power using the respective circuit breaker.
- 3 Activate **Heating** operation via the user interface.
- 4 With the 4-way valve connector connected to the PCB, measure the voltage on the 4-way valve connection of the PCB.

Result: The measured voltage MUST be:

Class	Voltage
Class 20~35	12 V DC
Class 42~71	220~240 V AC



INFORMATION

Actual energize voltage is ± 310 V DC. 12 V DC is used to keep the coil energized.

- 5 De-activate **Heating** and activate **Cooling** operation via the user interface.
- 6 Measure the voltage on the 4-way valve connection on the PCB.

Result: The measured voltage MUST be:

Class	Voltage
Class 20~35	0 V DC
Class 42~71	0 V AC

Are the measured voltages correct?	Action
Yes	Perform a position check of the 4-way valve, see "4.1.1 Checking procedures" [▶ 52].
No	Perform a check the main PCB, see "4.12 Main PCB" [▶ 129].

When outdoor temperature does not allow the unit to run in cooling or heating mode



INFORMATION

Follow this procedure when the outdoor temperature is outside the temperature range for one of the operation modes (**Heating** or **Cooling**). The unit CANNOT operate in the mode for which the outdoor temperature is outside its temperature range. See the databook on Business Portal for the temperature range of the operation modes.

- 1 Connect the 4-way valve connector to the appropriate PCB.

- 2 Turn ON the power using the respective circuit breaker.
- 3 With the unit operating, connect the service monitoring tool to the unit and check whether the unit is operating in **Heating** or **Cooling** mode.
- 4 With the 4-way valve connector connected to the PCB, measure the voltage on the 4-way valve connection of the PCB.

Result: The measured voltage MUST be:

Class	Voltage
Class 20~35	12 V DC when operating in Heating mode
	0 V DC when operating in Cooling mode
Class 42~71	220~240 V AC when operating in Heating mode
	0 V AC when operating in Cooling mode



INFORMATION

Actual energize voltage is ± 310 V DC. 12 V DC is used to keep the coil energized.

Is the measured voltage correct?	Action
Yes	Perform a position check of the 4-way valve, see " 4.1.1 Checking procedures " [▶ 52].
No	Perform a check the main PCB, see " 4.12 Main PCB " [▶ 129].

To perform a position check of the 4-way valve

- 1 First perform an electrical check of the 4-way valve, see "[4.1.1 Checking procedures](#)" [▶ 52].

When outdoor temperature is mild and unit can switch between heating and cooling



INFORMATION

This procedure is ONLY possible when the outdoor temperature is within the temperature range for both **Heating** and **Cooling** operation mode. See the databook on Business Portal for the temperature range of the operation modes.

- 1 Activate **Heating** operation via the user interface.



INFORMATION

It is recommended to connect the service monitoring tool to the unit and verify the operation mode of the 4-way valve.

- 2 Check with a contact thermometer (or by touching) if the flow through the 4-way valve corresponds with the flow shown in the flow diagram. (See "[7.3 Piping diagram](#)" [▶ 247]).

Is the flow correct?	Action
Yes	Skip the next step of this procedure.

Is the flow correct?	Action
No	Perform the next step of this procedure.

- 3 Connect a manifold to one of the service ports of the refrigerant circuit and check the pressure (suction, discharge). Compare with normal operation conditions of the unit.

Refrigerant pressure correct?	Action
Yes	Replace the body of the 4-way valve, see "4.1.2 Repair procedures" [▶ 56].
No	Leaks may be found in the refrigerant circuit. Perform a pressure test of the refrigerant circuit, see "5.2.1 Checking procedures" [▶ 214].

- 4 De-activate **Heating** and activate **Cooling** operation via the user interface.
- 5 Check with a contact thermometer (or by touching) if the flow through the 4-way valve corresponds with the flow shown in the flow diagram. (See ["7.3 Piping diagram"](#) [▶ 247]).

Is the flow correct?	Action
Yes	4-way valve is OK. Return to the troubleshooting of the specific error and continue with the next procedure.
No	Replace the body of the 4-way valve, see "4.1.2 Repair procedures" [▶ 56].

When outdoor temperature does not allow the unit to run in cooling or heating mode



INFORMATION

Follow this procedure when the outdoor temperature is outside the temperature range for one of the operation modes (**Heating** or **Cooling**). The unit CANNOT operate in the mode for which the outdoor temperature is outside its temperature range. See the databook on Business Portal for the temperature range of the operation modes.

- 1 With the unit operating, connect the service monitoring tool to the unit and check whether the unit is operating in **Heating** or **Cooling** mode.
- 2 Check with a contact thermometer (or by touching) if the flow through the 4-way valve corresponds with the flow shown in the flow diagram of the specific operation mode. (See ["7.3 Piping diagram"](#) [▶ 247]).

Is the flow correct?	Action
Yes	4-way valve is OK. Return to the troubleshooting of the specific error and continue with the next procedure.
No	Perform the next step of this procedure.

- 3 Connect a manifold to one of the service ports of the refrigerant circuit and check the pressure (suction, discharge). Compare with normal operation conditions of the unit.

Refrigerant pressure correct?	Action
Yes	Replace the body of the 4-way valve, see "4.1.2 Repair procedures" [▶ 56].
No	Leaks may be found in the refrigerant circuit. Perform a pressure test of the refrigerant circuit, see "5.2.1 Checking procedures" [▶ 214].

4.1.2 Repair procedures

To remove the 4-way valve coil

Prerequisite: Stop the unit operation via the user interface.

Prerequisite: Turn OFF the respective circuit breaker.

Prerequisite: Remove the required plate work, see "4.14 Plate work" [▶ 157].

Prerequisite: If needed, remove any parts to create more space for the removal of the 4-way valve coil.

- 1 Remove the screw and remove the 4-way valve coil from the 4-way valve body.

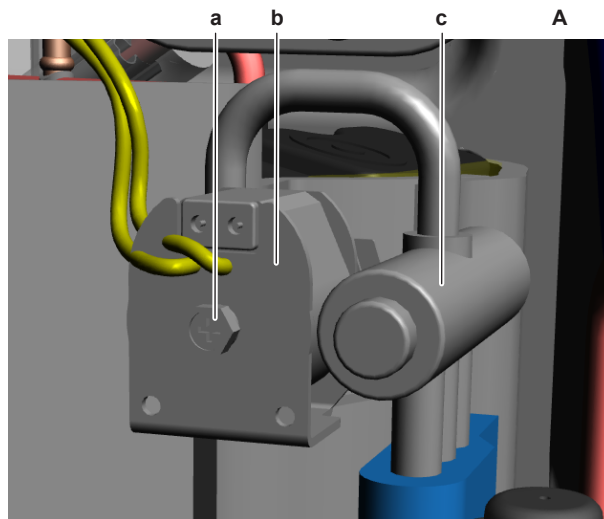

- A Class 20~35 unit
- a Screw
- b 4-way valve coil
- c 4-way valve body

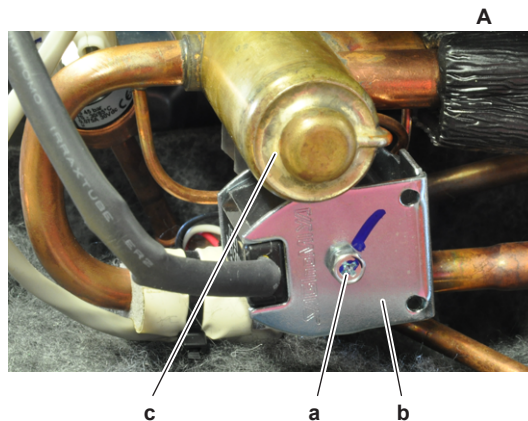

- A Class 42~71 unit
- a Screw
- b 4-way valve coil

- c 4-way valve body
- 2 Cut all tie straps that fix the 4-way valve coil harness.
 - 3 Unplug the 4-way valve connector from the appropriate PCB.
 - 4 To install the 4-way valve coil, see "[4.1.2 Repair procedures](#)" [[▶ 56](#)].

To remove the 4-way valve body

Prerequisite: Recuperate the refrigerant from the refrigerant circuit, see "[5.2.2 Repair procedures](#)" [[▶ 219](#)].

- 1 Remove the 4-way valve coil from the 4-way valve body, see "[4.1.2 Repair procedures](#)" [[▶ 56](#)].
- 2 Remove and keep the putty (if installed) and the insulation (if installed) for re-use.
- 3 Supply nitrogen to the refrigerant circuit. The nitrogen pressure MUST NOT exceed 0.02 MPa.
- 4 Wrap a wet rag around the components near the 4-way valve pipes. Heat the brazing points of the 4-way valve pipes using an oxygen acetylene torch and remove the 4-way valve pipes from the refrigerant pipes using pliers.

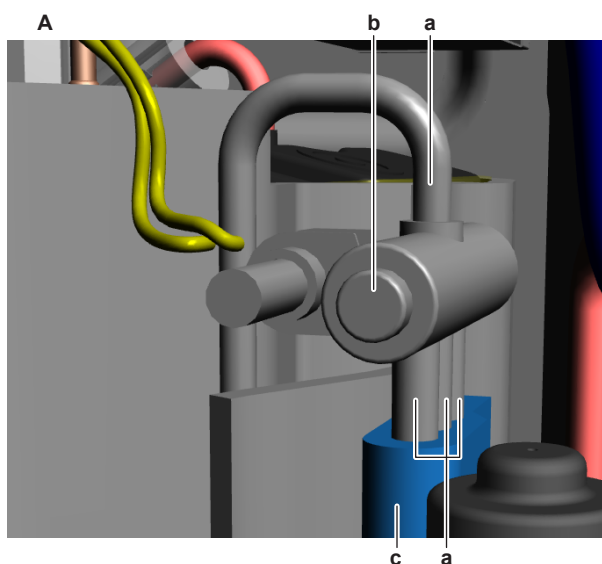

- A Class 20~35 unit
- a 4-way valve pipe
- b 4-way valve
- c Putty

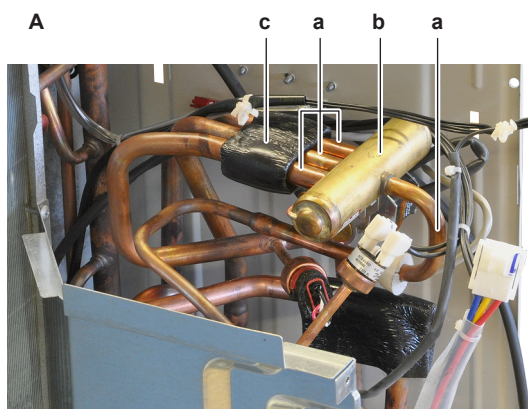

- A Class 42~71 unit
- a 4-way valve pipe
- b 4-way valve
- c Putty

- 5 Stop the nitrogen supply when the piping has cooled down.
- 6 Remove the 4-way valve.



INFORMATION

It is ALSO possible to cut the component pipe(s) using a pipe cutter. Make sure to remove the remaining component pipe end(s) from the refrigerant pipes by heating the brazing point(s) of the component pipe(s) using an oxygen acetylene torch.

- 7 Install plugs or caps on the open pipe ends of the refrigerant piping to avoid dirt or impurities from entering the piping.
- 8 To install the 4-way valve body, see "[4.1.2 Repair procedures](#)" [▶ 56].

To install the 4-way valve body

- 1 Remove the plugs or caps from the refrigerant piping and make sure they are clean.
- 2 Remove the 4-way valve coil from the spare part 4-way valve body.
- 3 Install the 4-way valve body in the correct location and correctly oriented. Insert the pipe ends in the pipe expansions.
- 4 Supply nitrogen to the refrigerant circuit. The nitrogen pressure MUST NOT exceed 0.02 MPa.
- 5 Wrap a wet rag around the 4-way valve body and any other components near the 4-way valve and solder the 4-way valve pipes to the refrigerant pipes.

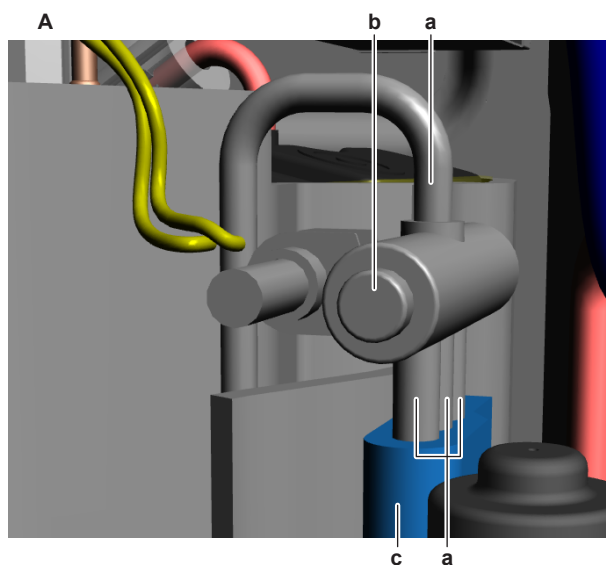

- A Class 20~35 unit
- a 4-way valve pipe
- b 4-way valve
- c Putty

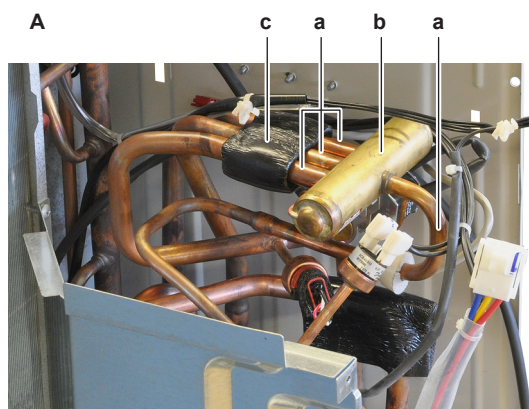

- A Class 42~71 unit
- a 4-way valve pipe
- b 4-way valve
- c Putty

**CAUTION**

Overheating the valve will damage or destroy it.

- 6 After soldering is done, stop the nitrogen supply after the component has cooled-down.
- 7 Install the putty (if available) and the insulation (if available) in their original location.
- 8 Install the 4-way valve coil on the 4-way valve body, see "[4.1.2 Repair procedures](#)" [▶ 56].
- 9 Perform a pressure test, see "[5.2.1 Checking procedures](#)" [▶ 214].
- 10 Add refrigerant to the refrigerant circuit, see "[5.2.2 Repair procedures](#)" [▶ 219].

To install the 4-way valve coil

- 1 Install the 4-way valve coil on the 4-way valve body.

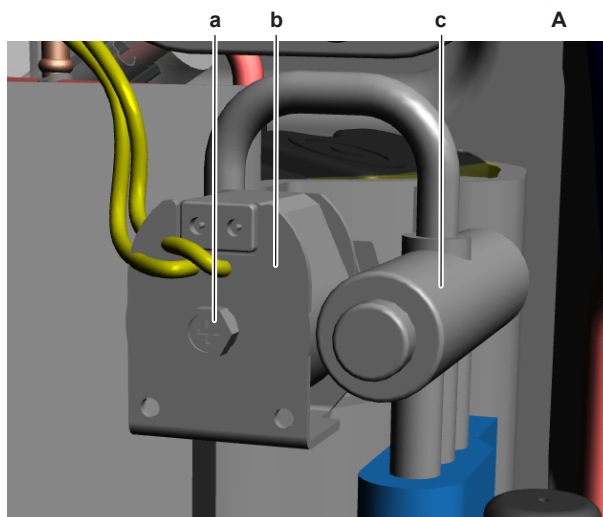

- A Class 20~35 unit
- a Screw
- b 4-way valve coil
- c 4-way valve body

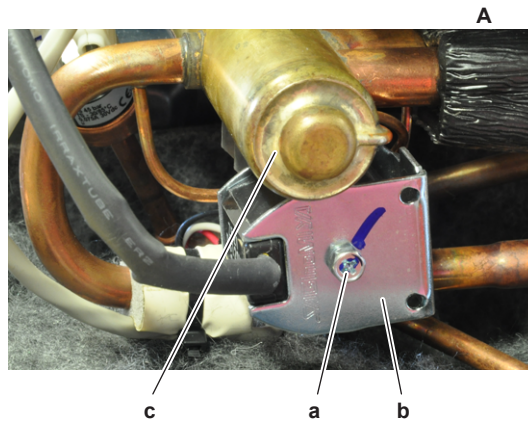

- A Class 42~71 unit
- a Screw
- b 4-way valve coil
- c 4-way valve body

- 2 Install and tighten the screw to fix the 4-way valve coil.
- 3 Route the 4-way valve coil harness towards the appropriate PCB.
- 4 Connect the 4-way valve connector to the appropriate PCB.



WARNING

When reconnecting a connector to the PCB, make sure to connect it on the correct location and do NOT apply force, as this may damage the connector or connector pins of the PCB.

- 5 Fix the 4-way valve coil harness using new tie straps.

Is the problem solved?	Action
Yes	No further actions required.
No	Return to the troubleshooting of the specific error and continue with the next procedure.

4.2 Compressor

4.2.1 Checking procedures



INFORMATION

It is recommended to perform the checks in the listed order.

To perform an auditive check of the compressor

Prerequisite: Stop the unit operation via the user interface.

Prerequisite: Turn OFF the respective circuit breaker.

Prerequisite: Remove the required plate work, see "[4.14 Plate work](#)" [▶ 157].

- 1 Open the compressor insulation.
- 2 Turn ON the power using the respective circuit breaker.
- 3 Start the unit operation via the user interface.
- 4 Wait for - or create condition to operate the compressor.

- 5 Listen to the compressor when it tries to operate. Judge if a mechanical lock is present.

**INFORMATION**

If you have a multimeter with data logging functionality, record the current in 1 of the U-V-W wires at compressor start-up. If mechanical lock is present, logged current will drastically increase to a peak value and the unit will trigger an error.

**INFORMATION**

If a mechanical lock is present, also check and eliminate the root cause. Mechanical lock is most likely caused by lack of lubrication (which might be related to overheat or wet operation), failing crankcase heater (if available), impurities in the refrigerant,

A mechanical lock is present on the compressor?	Action
Yes	Replace the compressor, see "4.2.2 Repair procedures" [▶ 67].
No	Perform an mechanical check of the compressor, see "4.2.1 Checking procedures" [▶ 60].

To perform a mechanical check of the compressor

Prerequisite: First perform an auditive check of the compressor, see ["4.2.1 Checking procedures"](#) [▶ 60].

Prerequisite: Stop the unit operation via the user interface.

Prerequisite: Turn OFF the respective circuit breaker.

- 1 Before proceeding:

**DANGER: RISK OF ELECTROCUTION**

Wait for at least 10 minutes after the circuit breaker has been turned OFF, to be sure the rectifier voltage is below 10 V DC before proceeding.

- 2 Visually check:
 - For oil drops around the compressor. Locate and fix as needed.
 - Pipes for signs of damage. Replace pipes as needed.
- 3 Check that the compressor bolts are correctly fixed. Fix as needed.
- 4 Check that the compressor wire terminals cover is correctly installed and fixed. Correct as needed.
- 5 Check the compressor dampers for any damage.



a Damper



INFORMATION

The compressor dampers may look different.

Compressor dampers are in a good condition?	Action
Yes	Perform an electrical check of the compressor, see "4.2.1 Checking procedures" [▶ 60].
No	Replace the compressor and/or damaged dampers, see "4.2.2 Repair procedures" [▶ 67].

To perform an electrical check of the compressor

- 1 First perform a mechanical check of the compressor, see ["4.2.1 Checking procedures"](#) [▶ 60].



DANGER: RISK OF ELECTROCUTION

Wait for at least 10 minutes after the circuit breaker has been turned OFF, to be sure the rectifier voltage is below 10 V DC before proceeding.

- 2 Remove the cover of the compressor wire terminals.

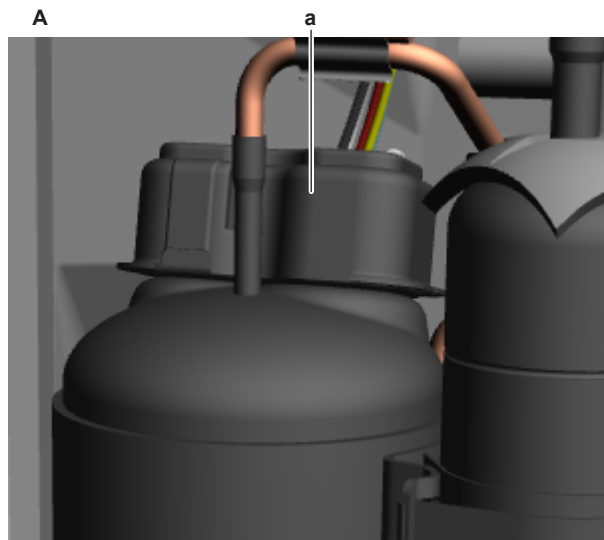

A Class 20~35 unit
a Compressor wire terminals cover

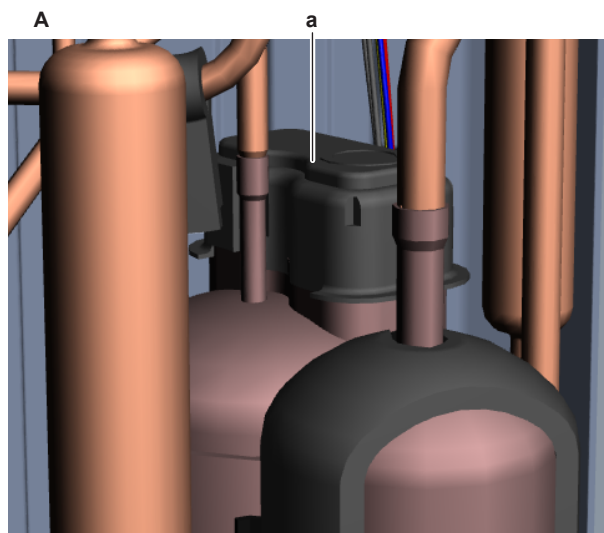

A Class 42~71 unit
a Compressor wire terminals cover

- 3** Disconnect the Faston connectors from the compressor wire terminals U, V and W.



INFORMATION

Note the position of the Faston connectors on the compressor wire terminals to allow correct connection during installation.

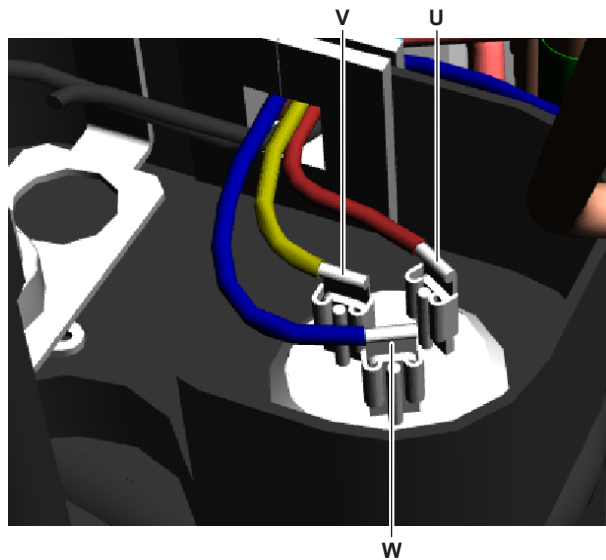

- U** Wire terminal U
- V** Wire terminal V
- W** Wire terminal W



CAUTION

Before measuring the compressor motor windings resistance, measure the resistance of the multimeter probes by holding the probes against each other. If the measured resistance is NOT 0 Ω, this value MUST be subtracted from the measured winding resistance.

- 4** Measure the resistance between the compressor motor windings U-V, V-W and U-W.

Result: All measurements MUST be approximately the same.

Unit	Compressor	Winding resistance value (at temperature of 20°C)
Class 20~35	M1C	1.89 Ω ± 5%
Class 42~60	M1C	1.114 Ω ± 5%
Class 71	M1C	0.274 Ω ± 5%

Compressor motor winding measurements are correct?	Action
Yes	Continue with the next step.
No	Replace the compressor, see "4.2.2 Repair procedures" [▶ 67].

- 5** Measure the continuity of the U, V and W wires between the compressor and the PCB. If no continuity, correct as needed, see "7.2 Wiring diagram" [▶ 235].
- 6** Connect the Faston connectors to the compressor wire terminals U, V and W

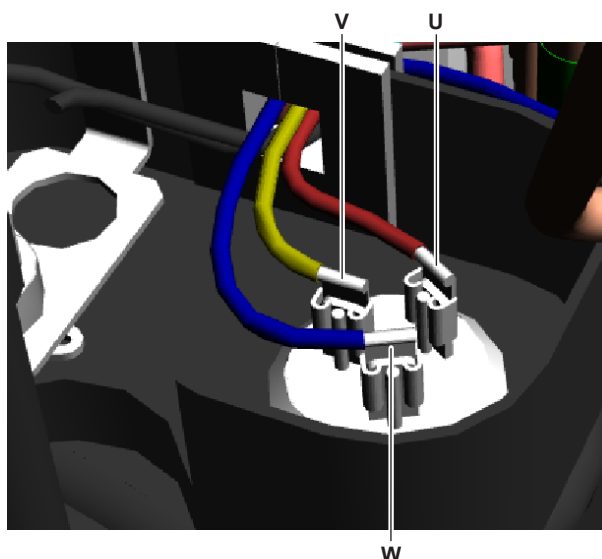

U Wire terminal U
V Wire terminal V
W Wire terminal W

- 7 Install the compressor wire terminals cover.
- 8 Install the compressor insulation.
- 9 Turn ON the power using the respective circuit breaker.
- 10 Start the unit operation via the user interface.



CAUTION

NEVER operate the compressor with the compressor wire terminals cover removed.

- 11 Wait for – or create condition to operate the compressor.
- 12 Once the compressor operates, measure the U-V-W inverter voltages. ALWAYS measure at the PCB side.

Result: All measurements MUST be the same.

Inverter voltage measurements are correct?	Action
Yes	Continue with the next step.
No	Perform a check of the appropriate PCB, see "4 Components" [▶ 52].

- 13 While compressor is operating, measure the current in each phase U, V and W. ALWAYS measure at the PCB side.

Result: All measurements MUST be the same.

Compressor motor winding current measurements are correct?	Action
Yes	Perform an insulation check of the compressor, see "4.2.1 Checking procedures" [▶ 60].
No	Preventively replace the compressor, see "4.2.2 Repair procedures" [▶ 67].

To perform an insulation check of the compressor

Prerequisite: First perform an electrical check of the compressor, see "4.2.1 Checking procedures" [▶ 60].

Prerequisite: Stop the unit operation via the user interface.

Prerequisite: Turn OFF the respective circuit breaker.

- 1 Before proceeding:



DANGER: RISK OF ELECTROCUTION

Wait for at least 10 minutes after the circuit breaker has been turned OFF, to be sure the rectifier voltage is below 10 V DC before proceeding.

- 2 Remove the cover of the compressor wire terminals.

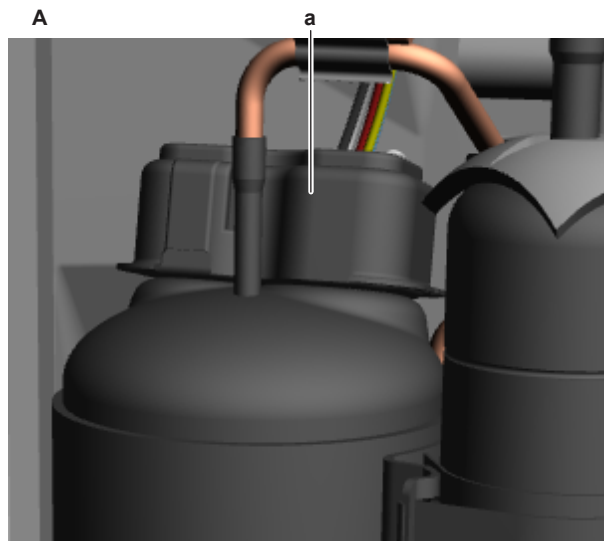

A Class 20~35 unit
a Compressor wire terminals cover

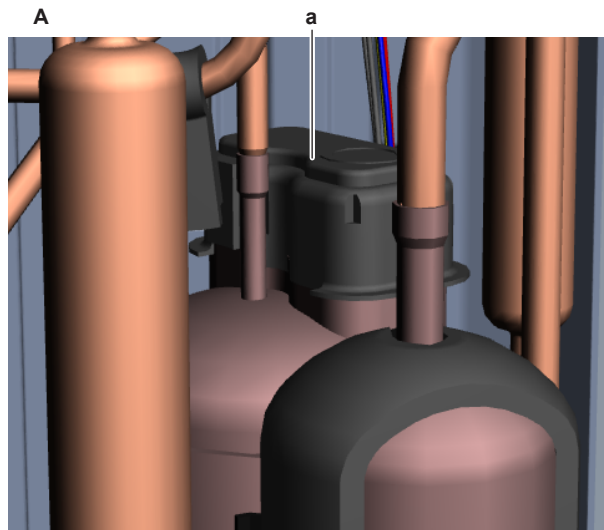

A Class 42~71 unit
a Compressor wire terminals cover

- 3 Disconnect the Faston connectors from the compressor wire terminals U, V and W.

**INFORMATION**

Note the position of the Faston connectors on the compressor wire terminals to allow correct connection during installation.

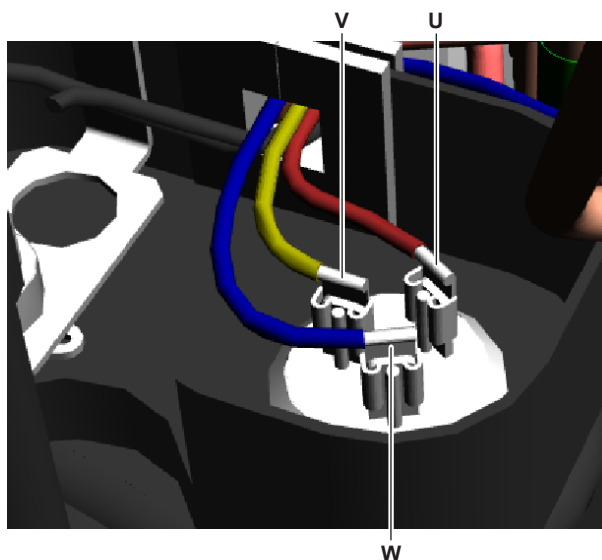

U Wire terminal U

V Wire terminal V

W Wire terminal W

- 4 Set the Megger voltage to 500 V DC or 1000 V DC.
- 5 Measure the insulation resistance between the following terminals. The measured insulation resistance MUST be >3 MΩ.
 - U–ground,
 - V–ground,
 - W–ground.

Compressor insulation measurements are correct?	Action
Yes	Compressor is OK. Return to troubleshooting of the specific error and continue with the next procedure.
No	Replace the compressor, see "4.2.2 Repair procedures" [▶ 67].

4.2.2 Repair procedures

To remove the compressor insulation

Prerequisite: Stop the unit operation via the user interface.

Prerequisite: Turn OFF the respective circuit breaker.

Prerequisite: Remove the required plate work, see ["4.14 Plate work"](#) [▶ 157].

- 1 Detach all the strings.

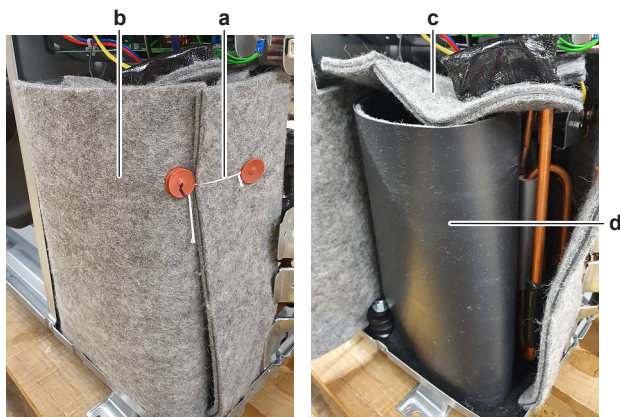

- a String
- b Body jacket (outer)
- c Top insulation
- d Secondary (inner) body jacket

- 2 Open the body jacket.
- 3 Remove the top insulation from the compressor.
- 4 Open the secondary body jacket from the compressor.
- 5 Remove the body jackets from the compressor.
- 6 To install the compressor insulation, see "[4.2.2 Repair procedures](#)" [[▶ 67](#)].

To install the compressor insulation

- 1 Install the secondary (inner) body jacket on the compressor.
- 2 Install the top insulation on the compressor.

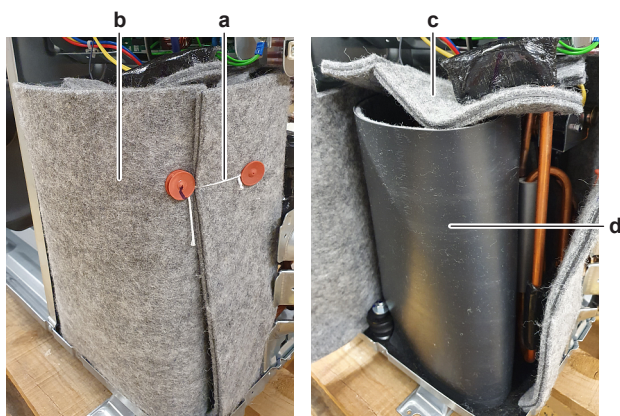

- a String
- b Body jacket (outer)
- c Top insulation
- d Secondary (inner) body jacket

- 3 Install the (outer) body jacket around the compressor.
- 4 Properly fit the top insulation in the body jacket.
- 5 Attach all strings to secure the body jacket.

To remove the compressor

Prerequisite: Stop the unit operation via the user interface.

Prerequisite: Turn OFF the respective circuit breaker.

Prerequisite: Remove the required plate work, see "[4.14 Plate work](#)" [[▶ 157](#)].

Prerequisite: Remove the compressor insulation.

Prerequisite: Recuperate the refrigerant from the refrigerant circuit, see "5.2.2 Repair procedures" [▶ 219].

- 1 If needed, remove any parts to create more space for the removal of the compressor.



DANGER: RISK OF ELECTROCUTION

Wait for at least 10 minutes after the circuit breaker has been turned OFF, to be sure the rectifier voltage is below 10 V DC before proceeding.

- 2 Remove the cover of the compressor wire terminals.

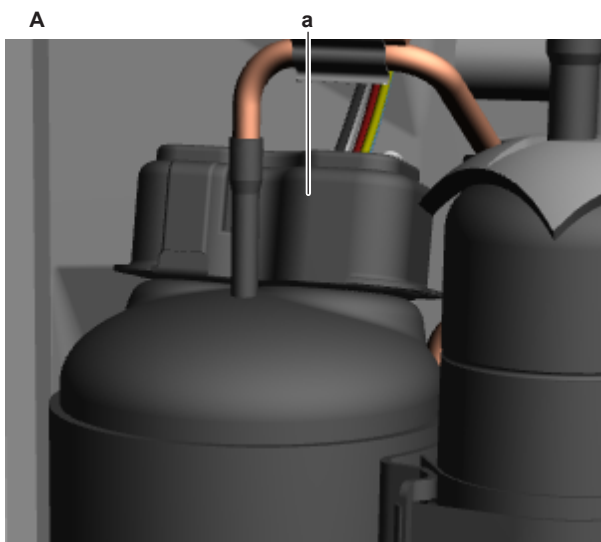

- A Class 20~35 unit
- a Compressor wire terminals cover

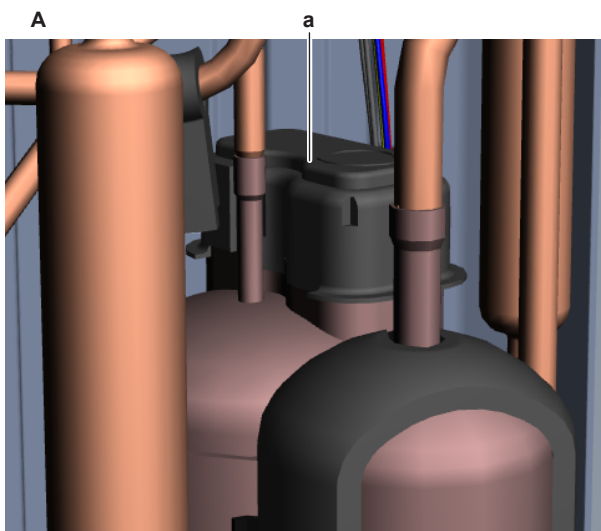

- A Class 42~71 unit
- a Compressor wire terminals cover

- 3 Disconnect the Faston connectors from the compressor wire terminals U, V and W.



INFORMATION

Note the position of the Faston connectors on the compressor wire terminals to allow correct connection during installation.

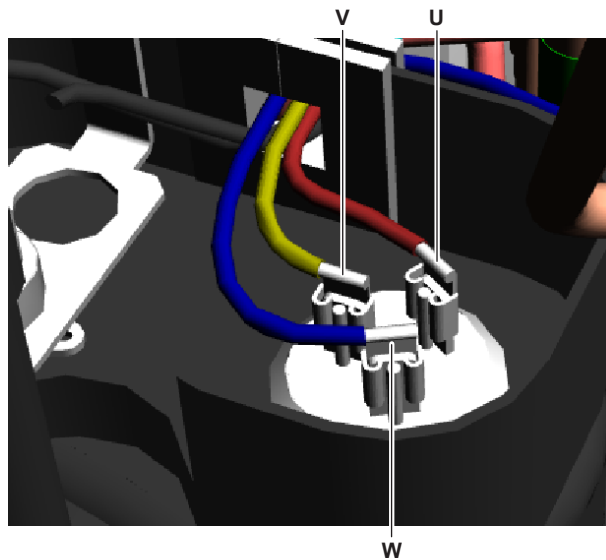

- U** Wire terminal U
- V** Wire terminal V
- W** Wire terminal W

- 4 If applicable, remove the screw and disconnect the ground wire from the compressor.
- 5 Remove the compressor thermal protector, see "[To remove the compressor thermal protector](#)" [▶ 78].
- 6 Remove the following thermistors from their holder:
 - Suction thermistor
 - Discharge pipe thermistor
 - Compressor body thermistor (if applicable)
- 7 Remove the putty from the compressor accumulator. Keep for reuse.
- 8 Supply nitrogen to the refrigerant circuit. The nitrogen pressure MUST NOT exceed 0.02 MPa.
- 9 Wrap a wet rag around the components near the compressor pipes. Heat the brazing points of the compressor pipes using an oxygen acetylene torch and remove the refrigerant pipes from the compressor pipes using pliers.

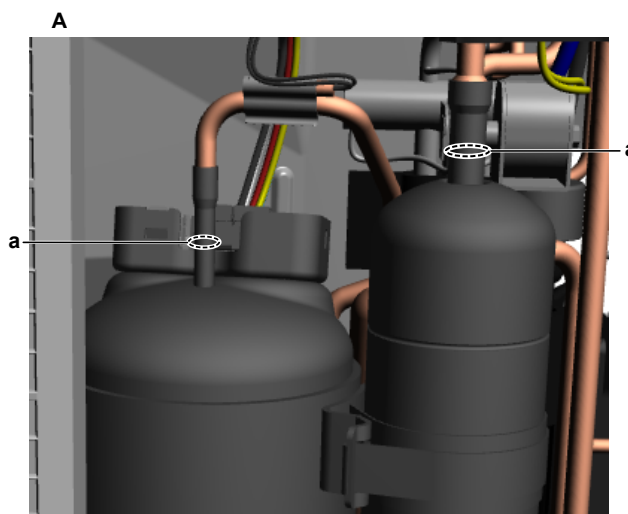

- A** Class 20~35 unit
- a** Compressor pipe

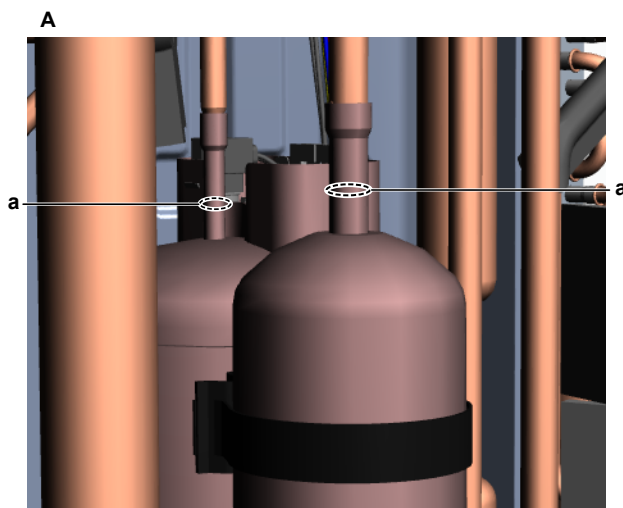

A Class 42~71 unit
a Compressor pipe

10 Stop the nitrogen supply when the piping has cooled down.



INFORMATION

It is ALSO possible to cut the component pipe(s) using a pipe cutter. Make sure to remove the remaining component pipe end(s) from the refrigerant pipes by heating the brazing point(s) of the component pipe(s) using an oxygen acetylene torch.

11 Remove the nuts and bolts and remove the compressor from the unit.

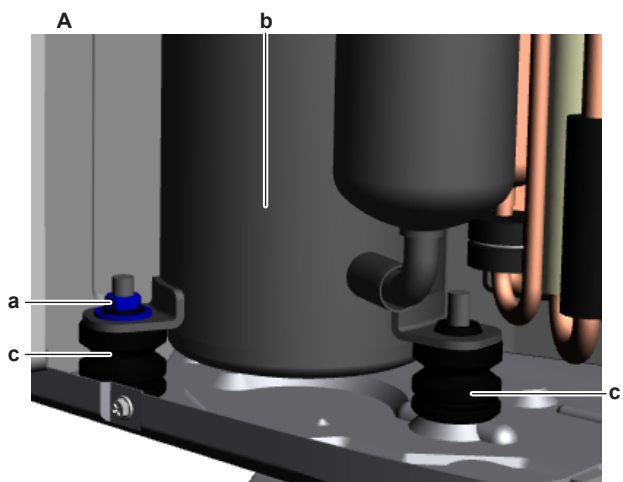

A Class 20~35 unit
a Nut
b Compressor
c Damper

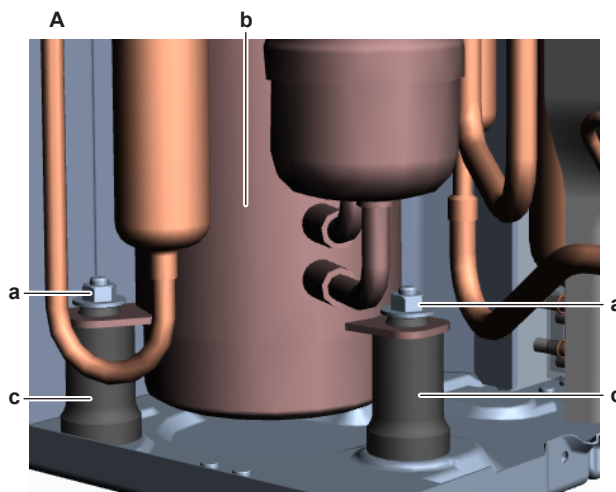

- A Class 42~71 unit
- a Nut
- b Compressor
- c Damper

12 Remove the 3 dampers from the compressor.



INFORMATION

The compressor dampers may look different.

13 Remove the bushings and keep them for re-use.

14 Install plugs or caps on the open pipe ends of the refrigerant piping to avoid dirt or impurities from entering the piping.

15 To install the compressor, see "[4.2.2 Repair procedures](#)" [▶ 67].

To install the compressor

- 1 Check the state of the dampers. Replace if worn.
- 2 Install the 3 dampers in the correct location on the unit.
- 3 Remove the plugs or caps from the refrigerant piping and make sure they are clean.
- 4 Remove the caps from the compressor pipes (of the new compressor).



CAUTION

The oil in the compressor is hygroscopic. Therefore remove the caps from the compressor pipes as late as possible.

- 5 Install the compressor on the correct location on the dampers. Properly insert the refrigerant pipes in the pipe expansions of the compressor pipes.
- 6 Install and tighten the bolts and nuts to fix the compressor to the dampers.

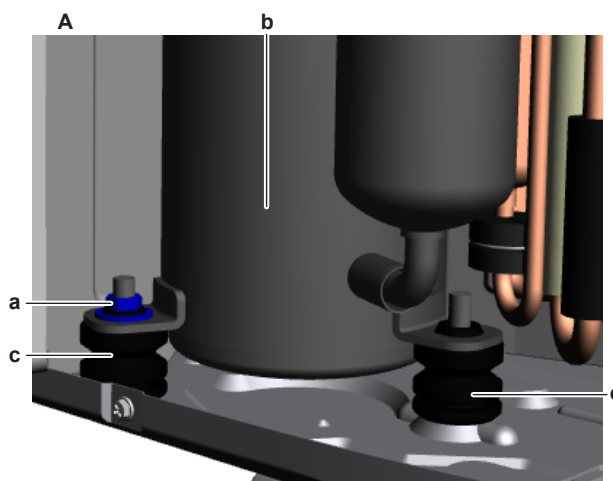

- A** Class 20~35 unit
a Nut
b Compressor
c Damper

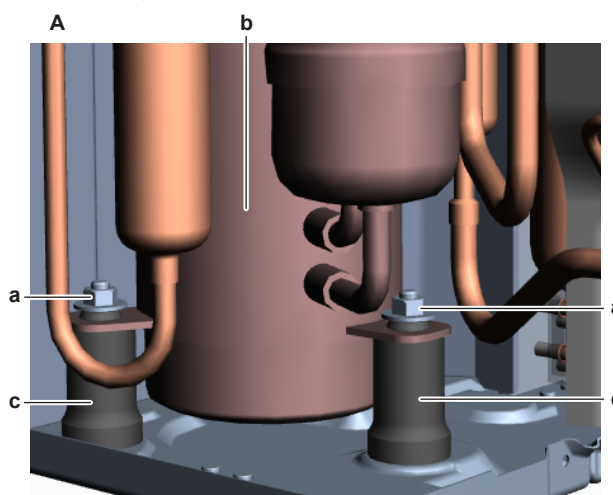

- A** Class 42~71 unit
a Nut
b Compressor
c Damper



INFORMATION

The compressor dampers may look different.

- 7** Supply nitrogen to the refrigerant circuit. The nitrogen pressure **MUST NOT** exceed 0.02 MPa.
- 8** Wrap a wet rag around the compressor pipes and any other components near the compressor and solder the compressor pipes to the refrigerant pipes.

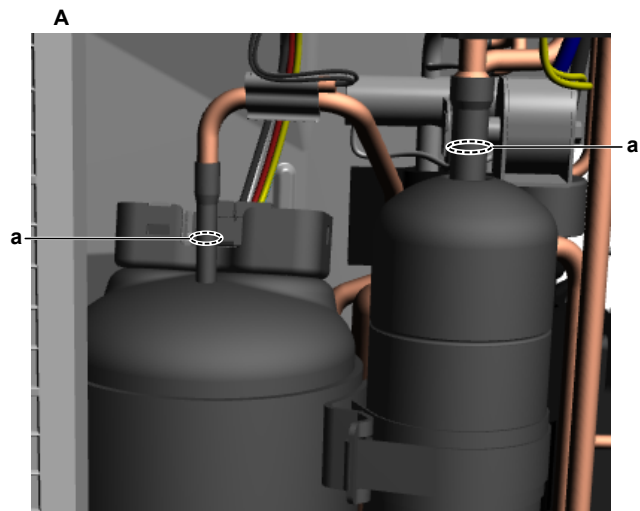

A Class 20~35 unit
a Compressor pipe

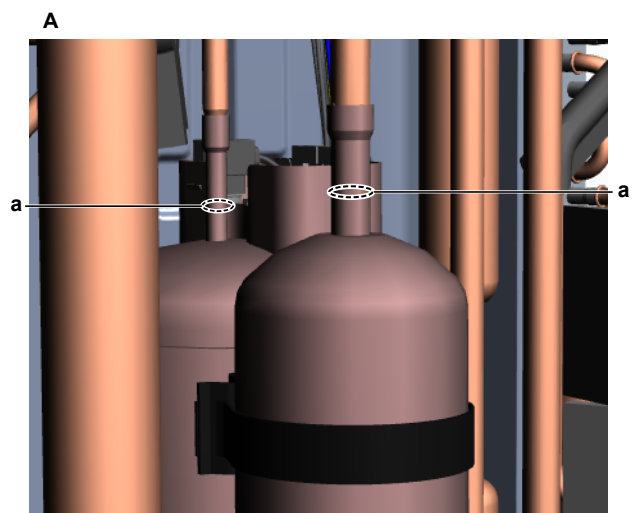

A Class 42~71 unit
a Compressor pipe



CAUTION

Overheating the compressor pipes (and the oil inside the compressor pipes) will damage or destroy the compressor.

- 9 After soldering is done, stop the nitrogen supply after the component has cooled-down.
- 10 Install the putty on the compressor accumulator.
- 11 Install the compressor thermal protector, see "[To install the compressor thermal protector](#)" [▶ 80].
- 12 Connect the Faston connectors to the compressor wire terminals U, V and W

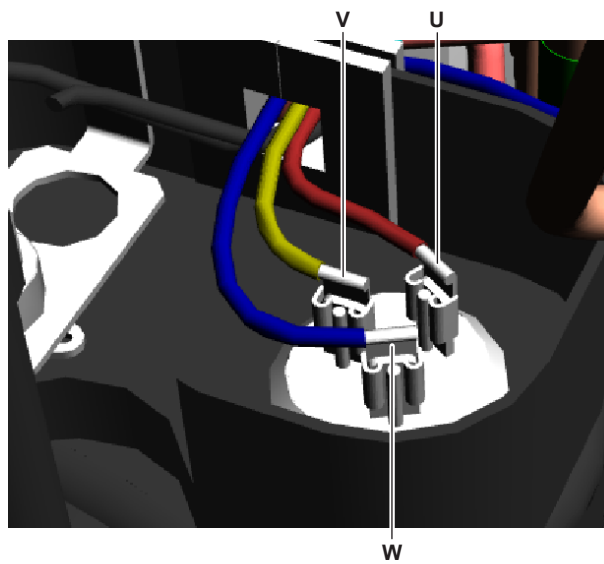

- U** Wire terminal U
- V** Wire terminal V
- W** Wire terminal W

13 Install the cover of the compressor wire terminals.

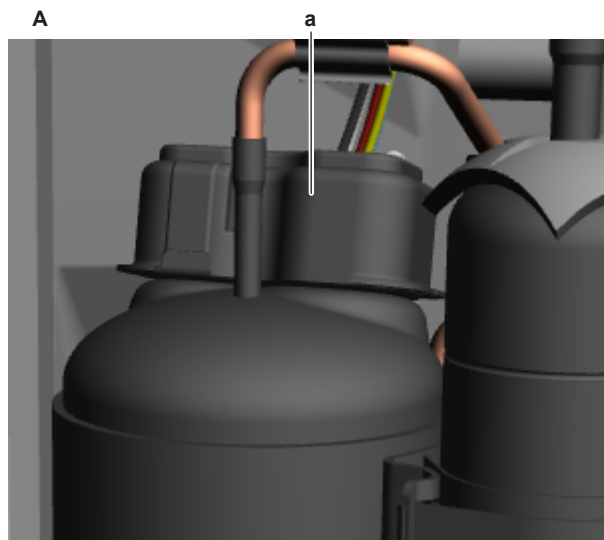

- A** Class 20~35 unit
- a** Compressor wire terminals cover

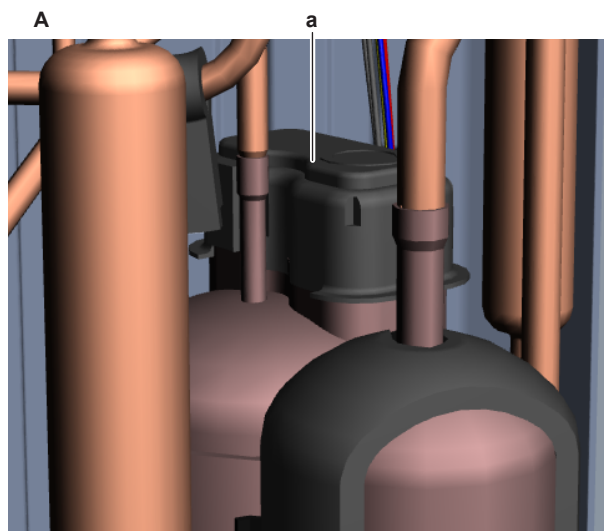

- A** Class 42~71 unit

a Compressor wire terminals cover

- 14 If applicable, connect the ground wire to the compressor. Install and tighten the screw to fix the ground wire.
- 15 Install the following thermistors in their holder:
 - Suction thermistor
 - Discharge pipe thermistor
 - Compressor body thermistor (if applicable)
- 16 Install the compressor insulation, see "4.2.2 Repair procedures" [▶ 67].
- 17 Perform a pressure test, see "5.2.1 Checking procedures" [▶ 214].
- 18 Add refrigerant to the refrigerant circuit, see "5.2.2 Repair procedures" [▶ 219].

Is the problem solved?	Action
Yes	No further actions required.
No	Return to the troubleshooting of the specific error and continue with the next procedure.

4.3 Compressor thermal protector

4.3.1 Checking procedures

To perform a mechanical check of the compressor thermal protector

Prerequisite: Stop the unit operation via the user interface.

Prerequisite: Turn OFF the respective circuit breaker.

Prerequisite: Remove the required plate work, see "4.14 Plate work" [▶ 157].

Prerequisite: Remove the compressor insulation.

- 1 Remove the cover of the compressor wire terminals.

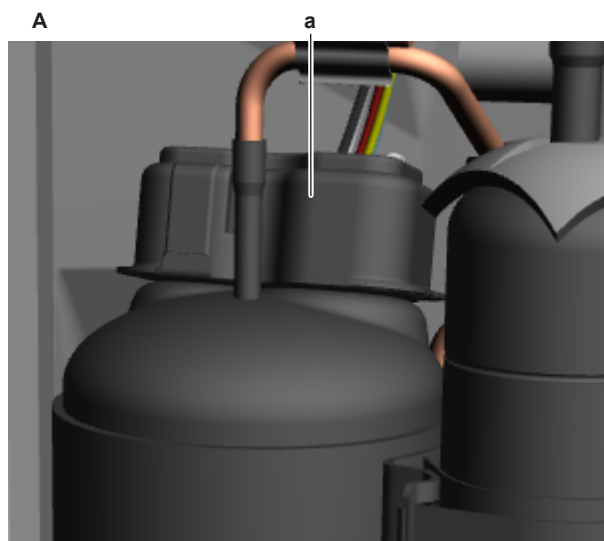

A Class 20~35 unit
a Compressor wire terminals cover

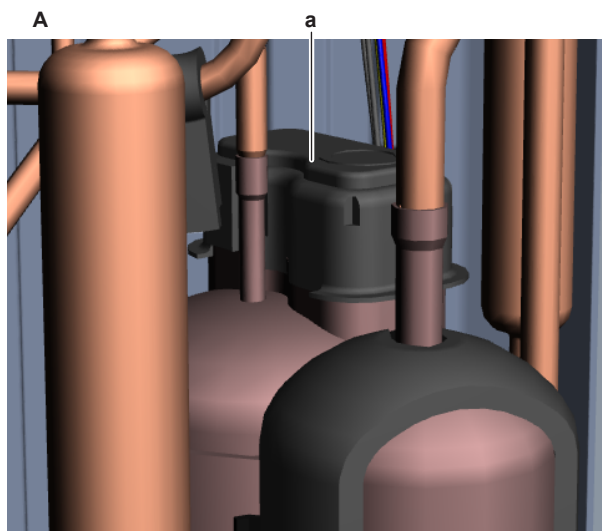

- A Class 42~71 unit
- a Compressor wire terminals cover

- 2 Remove the compressor thermal protection with bracket from the compressor.

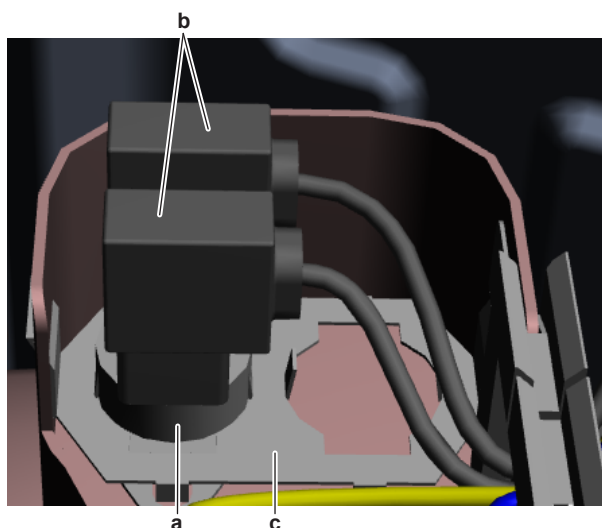

- a Compressor thermal protector
- b Faston connector
- c Bracket

- 3 If in doubt, measure the temperature of the compressor thermal protection.
Result: The temperature MUST be below 85°C.
- 4 Disconnect the Faston connectors from the compressor thermal protection.



INFORMATION

Make sure that the wiring between the compressor thermal protector and the connector on the PCB is properly connected and NOT damaged (check continuity), see "[7.2 Wiring diagram](#)" [▶ 235].

- 5 Using a hot air gun, carefully heat the compressor thermal protection to slightly above 123°C for Class 20~60 units or 133°C for Class 71 units (compressor thermal protection trips at 117~123°C for Class 20~60 units and 127~133°C for Class 71 units).
- 6 Measure the resistance on the compressor thermal protector.
Result: The contact MUST be open (measured resistance = OL).

- 7 Let the compressor thermal protection cool down below 85°C (reset temperature is 85~105°C).
- 8 Again measure the resistance on the compressor thermal protector.

Result: The contact MUST be closed (measured resistance = 0 Ω).

Does the compressor thermal protector contact open and close at the correct temperature?	Action
Yes	Return to the troubleshooting of the specific error and continue with the next procedure.
No	Replace the compressor thermal protector, see " 4.3.2 Repair procedures " [▶ 78].

4.3.2 Repair procedures

To remove the compressor thermal protector

Prerequisite: Stop the unit operation via the user interface.

Prerequisite: Turn OFF the respective circuit breaker.

Prerequisite: Remove the required plate work, see "[4.14 Plate work](#)" [▶ 157].

Prerequisite: Remove the compressor insulation.

- 1 Remove the cover of the compressor wire terminals.

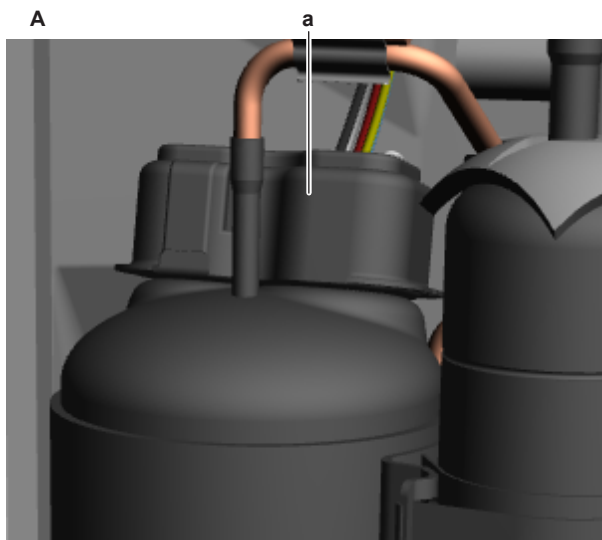

A Class 20~35 unit
a Compressor wire terminals cover

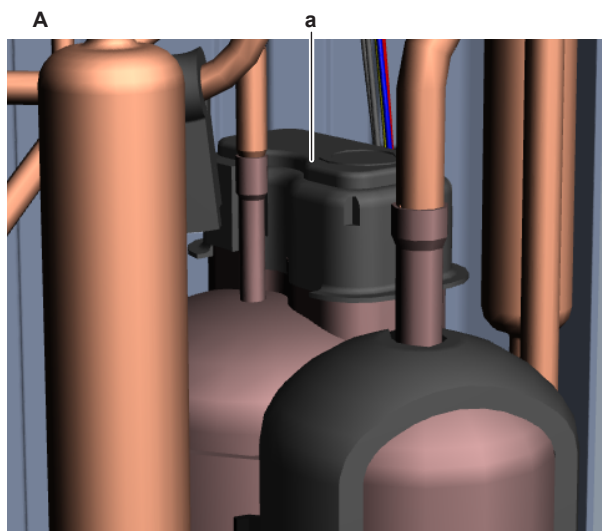

- A** Class 42~71 unit
- a** Compressor wire terminals cover

- 2** Remove the compressor thermal protector with bracket from the compressor housing.

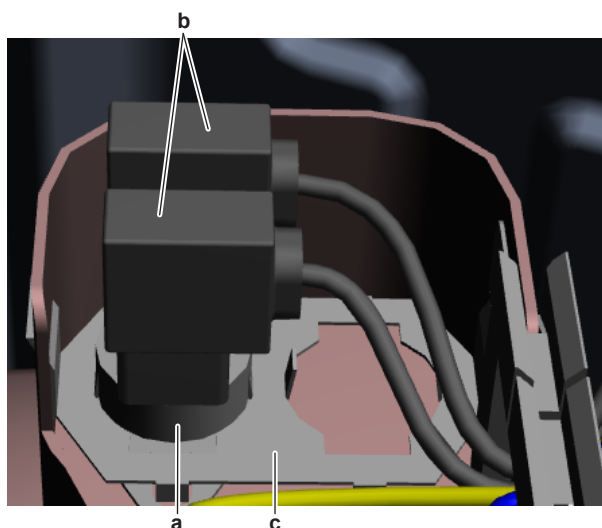

- a** Compressor thermal protector
- b** Faston connector
- c** Bracket

- 3** Disconnect the Faston connectors from the compressor thermal protector.
- 4** Separate the compressor thermal protector and the compressor thermal protector bracket.

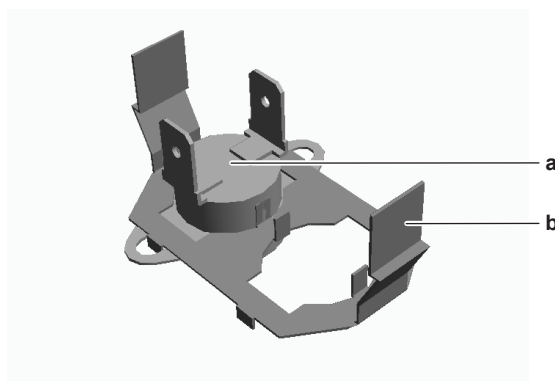

- a** Compressor thermal protector
- b** Compressor thermal protector bracket

- 5 To install the compressor thermal protector, see ["4.2.2 Repair procedures" \[▶ 67\]](#).

To install the compressor thermal protector

- 1 Install the compressor thermal protector on the compressor thermal protector bracket.

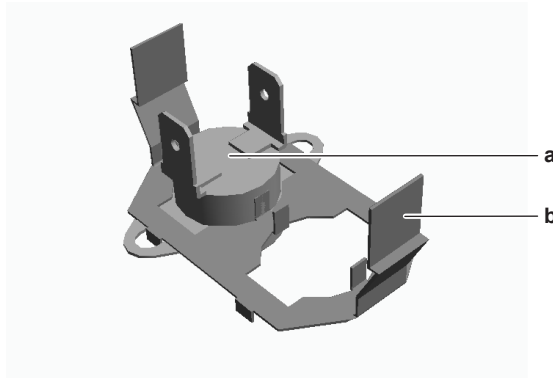

- a Compressor thermal protector
- b Compressor thermal protector bracket

- 2 Connect the Faston connectors to the compressor thermal protector.

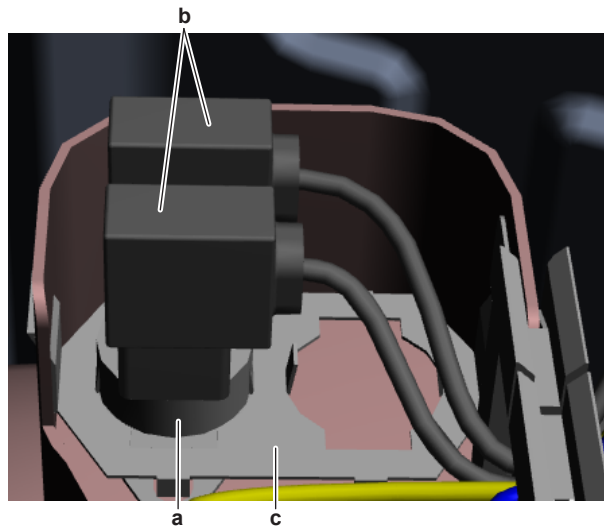

- a Compressor thermal protector
- b Faston connector
- c Bracket

- 3 Install the compressor thermal protector in the compressor housing.
- 4 Install the wire terminals cover on the compressor.

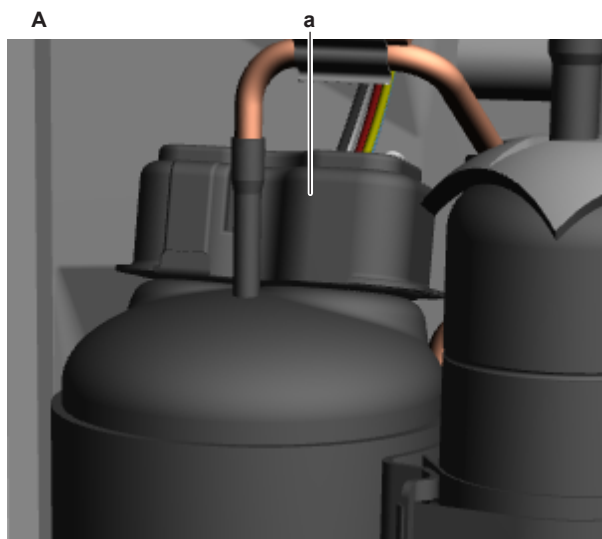

A Class 20~35 unit
a Compressor wire terminals cover

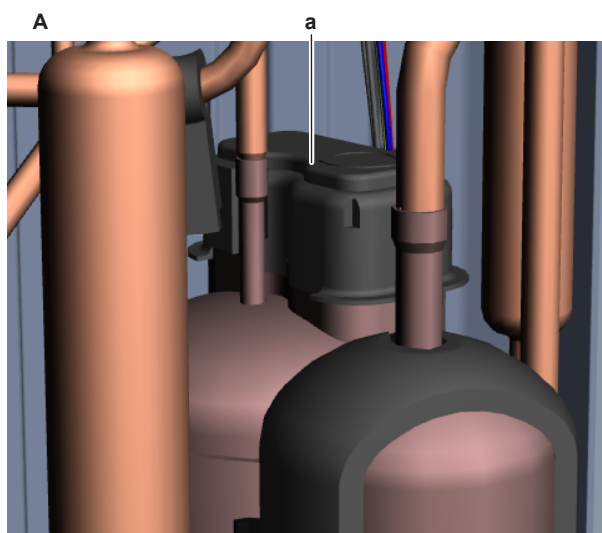

A Class 42~71 unit
a Compressor wire terminals cover

5 Install the compressor insulation.

Is the problem solved?	Action
Yes	No further actions required.
No	Return to the troubleshooting of the specific error and continue with the next procedure.

4.4 Damper motor

4.4.1 Checking procedures

To perform an electrical check of the damper motor

Prerequisite: Stop the unit operation via the user interface.

Prerequisite: Turn OFF the respective circuit breaker.

Prerequisite: Remove the required plate work, see "[4.14 Plate work](#)" [▶ 157].

- 1 Disconnect the damper motor connector S400 from the indoor unit main PCB.
- 2 Measure the resistance between the following pins of the damper motor connector.

Result: The measurements MUST be as shown in the table below.

Pins	Measured resistance (Ω)
1-2	139.5~160.5
1-13	
1-14	
1-15	
2-13	279~321
2-14	
2-15	
13-14	
13-15	
14-15	

Damper motor resistance measurements are correct?	Action
Yes	Return to the troubleshooting of the specific error and continue with the next procedure.
No	Continue with the next step.

- 3 Remove the damper motor, see "[4.4.2 Repair procedures](#)" [▶ 83].
- 4 Measure the resistance between the following pins of the connector on the damper motor.

Result: The measurements MUST be as shown in the table below.

Pins	Measured resistance (Ω)
1-2	139.5~160.5
1-3	
1-4	
1-5	
2-3	279~321
2-4	
2-5	
3-4	
3-5	
4-5	

Damper motor resistance measurements are correct?	Action
Yes	Replace the damper motor wiring harness, see " 4.4.2 Repair procedures " [▶ 83].

Damper motor resistance measurements are correct?	Action
No	Replace the damper motor, see "4.4.2 Repair procedures" [▶ 83].

4.4.2 Repair procedures

To remove the damper motor

Prerequisite: Stop the unit operation via the user interface.

Prerequisite: Turn OFF the respective circuit breaker.

Prerequisite: Remove the required plate work, see ["4.14 Plate work"](#) [▶ 157].

- 1 Put a small drain pan (or container) under the drain hose.
- 2 Remove the screw from the fixation bracket and pull the drain hose downwards to remove it from the indoor unit.

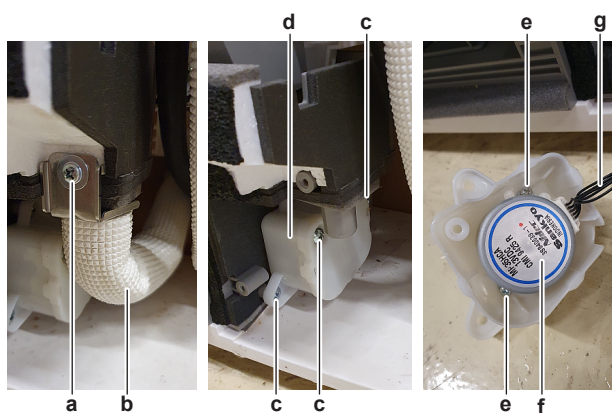

- a Screw (drain hose)
- b Drain hose
- c Screw (damper motor cover)
- d Damper motor cover
- e Screw (damper motor)
- f Damper motor
- g Damper motor wiring harness

- 3 Remove the 3 screws and remove the damper motor cover from the indoor unit.
- 4 Remove the 2 screws to remove the damper motor from the cover.
- 5 Disconnect the damper motor wiring harness from the damper motor.
- 6 To install the damper motor, see ["4.4.2 Repair procedures"](#) [▶ 83].

To install the damper motor

- 1 Connect the damper motor wiring harness to the damper motor.
- 2 Install the damper motor in the correct location on the damper motor cover. Fix the damper moto to the cover using the 2 screws.

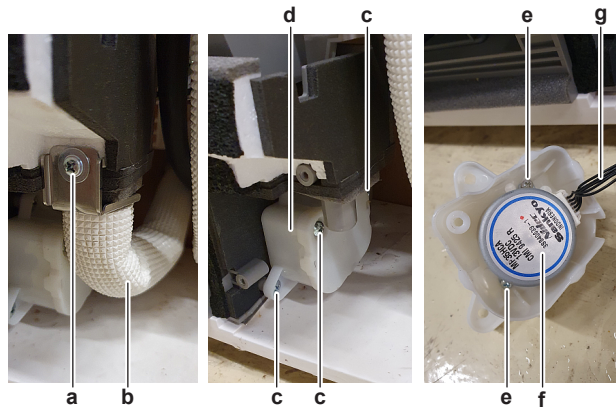

- a Screw (drain hose)
- b Drain hose
- c Screw (damper motor cover)
- d Damper motor cover
- e Screw (damper motor)
- f Damper motor
- g Damper motor wiring harness

- 3 Install the damper motor cover in the correct location on the indoor unit. Make sure that the damper motor shaft is correctly inserted in the gear.
- 4 Install and tighten the 3 screw to fix damper motor covers.
- 5 Connect the drain hose to the indoor unit.
- 6 Install the drain hose fixation bracket. Install and tighten the screw.

Is the problem solved?	Action
Yes	No further actions required.
No	Return to the troubleshooting of the specific error and continue with the next procedure.

To remove the damper motor wiring harness

Prerequisite: Remove the damper motor, see "4.4.2 Repair procedures" [▶ 83].

- 1 Remove the screw to disconnect the tie strap.

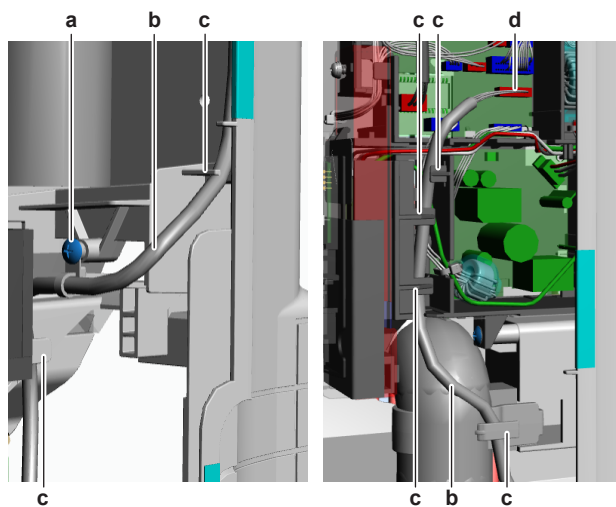

- a Screw (tie strap)
- b Damper motor wiring harness
- c Harness retainer
- d Damper motor connector on indoor unit main PCB

- 2 Route the damper motor wiring harness out of the harness retainers.

- 3 Disconnect the damper motor wiring harness from the indoor unit main PCB.
- 4 To install the damper motor wiring harness, see "[4.4.2 Repair procedures](#)" [▶ 83].

To install the damper motor wiring harness

- 1 Connect the damper motor wiring harness to the indoor unit main PCB.



WARNING

When reconnecting a connector to the PCB, make sure to connect it on the correct location and do NOT apply force, as this may damage the connector or connector pins of the PCB.

- 2 Route the damper motor wiring harness through the harness retainers.

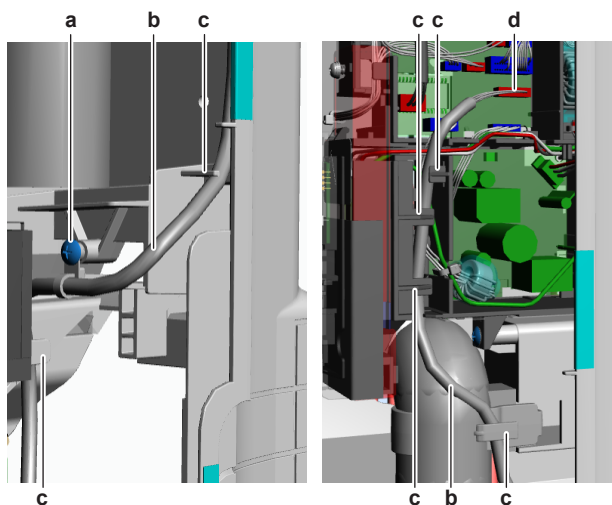

- a Screw (tie strap)
- b Damper motor wiring harness
- c Harness retainer
- d Damper motor connector on indoor unit main PCB

- 3 Install a new tie strap to fix the wiring harness. Install and tighten the screw.
- 4 Install the damper motor, see "[4.4.2 Repair procedures](#)" [▶ 83].

Is the problem solved?	Action
Yes	No further actions required.
No	Return to the troubleshooting of the specific error and continue with the next procedure.

4.5 Expansion valve

4.5.1 Checking procedures



INFORMATION

It is recommended to perform the checks in the listed order.

To perform a mechanical check of the expansion valve

Prerequisite: Power OFF the unit for 3 minutes. Then turn ON the unit and listen to the expansion valve assembly. If the expansion valve does NOT make a latching sound, continue with the electrical check of the expansion valve, see "4.5.1 Checking procedures" [▶ 85].

Prerequisite: Stop the unit operation via the user interface.

Prerequisite: Turn OFF the respective circuit breaker.

Prerequisite: Remove the required plate work, see "4.14 Plate work" [▶ 157].

- 1 Remove the expansion valve insulation (if applicable) and visually check:
 - For oil drops around the expansion valve. Locate and fix as necessary.
 - Pipes for signs of damage. Replace pipes as needed.
 - Coil wires for signs of damage. Replace expansion valve coil as needed. See "4.5.2 Repair procedures" [▶ 89].
- 2 Remove the expansion valve coil from the expansion valve body, see "4.5.2 Repair procedures" [▶ 89].
- 3 Slide the expansion valve magnet over the expansion valve body and gently rotate the magnet clockwise/counterclockwise to manually close/open the expansion valve. Listen to check if the valve is closing/opening and manually close the valve when check is done.



INFORMATION

After the check, remove the magnet from the expansion valve body and install the expansion valve coil on the expansion valve body. Make sure that the expansion valve coil is correctly installed on the expansion valve body.



INFORMATION

It is highly recommended to perform a power reset after checking the valve using a magnet.

Does the expansion valve open?	Action
Yes	Perform an electrical check of the expansion valve, see "4.5.1 Checking procedures" [▶ 85].
No	Replace the expansion valve body, see "4.5.2 Repair procedures" [▶ 89].

To perform an electrical check of the expansion valve

- 1 First perform a mechanical check of the expansion valve, see "4.5.1 Checking procedures" [▶ 85].
- 2 Disconnect the electrical connector of the expansion valve coil from the appropriate PCB and measure the resistance of all windings (between the pins of each phase (wire) and the common wire) using a multi meter. All measurements MUST be approximately the same.

Name	Symbol	Location (PCB)	Connector	Winding resistance
Main expansion valve	Y1E	Main	S20	46±4 Ω

**INFORMATION**

Below are shown examples of the resistance measurements in which the common wire is connected to pin 5 or to pin 6 of the expansion valve coil connector. Connections may differ according to the type of expansion valve.

- Connector pin 1-5,
- Connector pin 2-5,
- Connector pin 3-5,
- Connector pin 4-5.

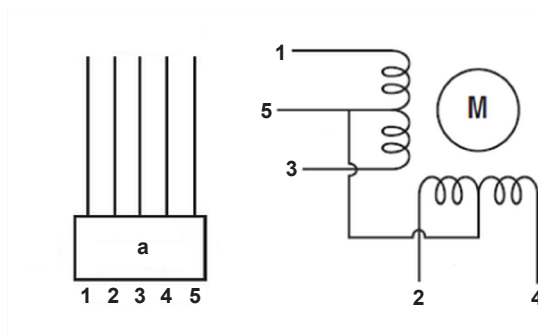

a Connector

- Connector pin 1-6,
- Connector pin 2-6,
- Connector pin 3-6,
- Connector pin 4-6.

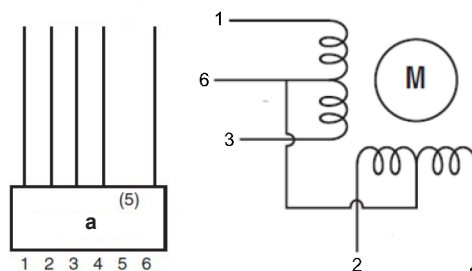

a Connector

- 3** Check the insulation resistance of the coil by measuring the resistance between the pins of each phase (1, 2, 3, 4) and GND on the unit.

Result: None of the measurements should be short-circuit.

**WARNING**

When reconnecting a connector to the PCB, make sure to connect it on the correct location and do NOT apply force, as this may damage the connector or connector pins of the PCB.

Is the measured resistance correct?	Action
Yes	Perform an operation check of the expansion valve, see "4.5.1 Checking procedures" [▶ 85].
No	Replace the expansion valve coil, "4.5.2 Repair procedures" [▶ 89].

To perform an operation check of the expansion valve

Prerequisite: First perform an electrical check of the expansion valve, see "4.5.1 Checking procedures" [▶ 85].

- 1 Turn ON the power of the unit.



INFORMATION

When power is switched ON, PCB checks all expansion valve coil windings by current check. If winding is short or open, expansion valve error is triggered.

- 2 Start the unit operation via the user interface.
- 3 With the unit operating, connect the service monitoring tool to the unit.
- 4 When the expansion valve is closed according to the service monitoring tool, check the inlet and outlet of the valve with a contact thermometer or use an expansion valve stethoscope to see if refrigerant flows through the expansion valve. Check that the valve is NOT bleeding.

Result: There MUST be NO flow through the expansion valve.

- 5 When the expansion valve is open according to the service monitoring tool, check the inlet and outlet of the valve with a contact thermometer or use an expansion valve stethoscope to see if refrigerant flows through the expansion valve.

Result: Refrigerant MUST flow through the expansion valve.

- 6 Wait for the PCB to command the expansion valve to open (when closed) or to close (when open) (pulse output to expansion valve visible on service monitoring tool).



INFORMATION

If the PCB does NOT command the expansion valve to open or close (when it is supposed to), perform a check of the appropriate thermistors and pressure sensors (as their measurements control the operation of the expansion valve(s)).

- 7 While in opening or closing sequence each expansion valve winding (Φ1, 2, 3, 4) is supplied with 12 V DC from the PCB. You will need a good multimeter, where its range is set to about 20 V DC, and during opening or closing sequence you may be able to measure the supply voltage for a short time. If you set the multimeter range to Auto, then most likely you may NOT read a value between switching ranges. The best way to check is to feel the movement of the valve by touching, rather than trying to measure the driving voltage.
- 8 When the expansion valve was commanded to close, check the inlet and outlet of the valve with a contact thermometer or use an expansion valve stethoscope to see if refrigerant flows through the expansion valve. Check that the valve is NOT bleeding.

Result: There MUST be NO flow through the expansion valve.

- 9 When the expansion valve was commanded to open, check the inlet and outlet of the valve with a contact thermometer or use an expansion valve stethoscope to see if refrigerant flows through the expansion valve.

Result: Refrigerant MUST flow through the expansion valve.

Is the flow through the expansion valve correct?	Action
Yes	Component is OK. Return to the troubleshooting of the specific error and continue with the next step.
No	Replace the expansion valve, see "4.5.2 Repair procedures" [▶ 89].

Problem solved?

After all checking procedures listed above have been performed:

Is the problem solved?	Action
Yes	No further actions required.
No	Return to the troubleshooting of the specific error and continue with the next procedure.

4.5.2 Repair procedures

To remove the expansion valve coil

Prerequisite: Stop the unit operation via the user interface.

Prerequisite: Turn OFF the respective circuit breaker.

Prerequisite: Remove the required plate work, see ["4.14 Plate work"](#) [▶ 157].

- 1 If needed, remove any parts or insulation to create more space for the removal.
- 2 Pull up the expansion valve coil to remove it from the expansion valve body.



INFORMATION

It may be needed to turn the expansion valve coil 1/8 turn counter clockwise to unlock it. Make sure to note the correct orientation (position) of the expansion valve coil before removal.

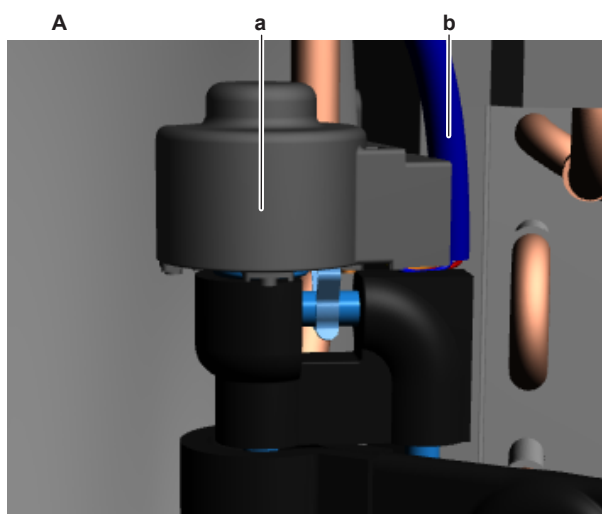

- A Class 20~35 unit
- a Expansion valve coil
- b Expansion valve coil harness

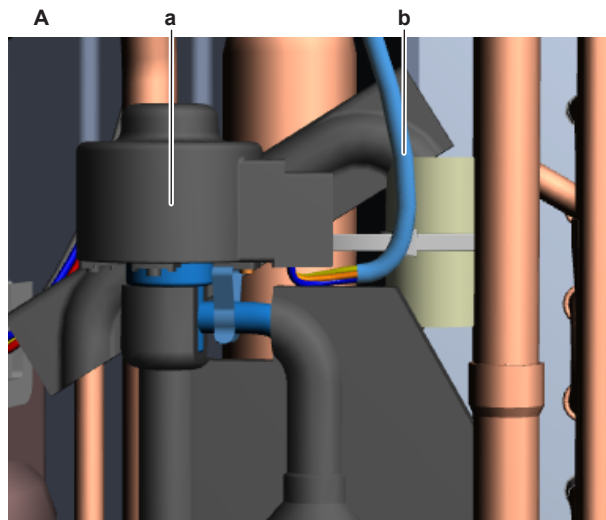

- A Class 42~71 unit
- a Expansion valve coil
- b Expansion valve coil harness

- 3 Cut all tie straps that fix the expansion valve coil harness.
- 4 Disconnect the expansion valve coil connector S20 from the main PCB.
- 5 Remove the expansion valve coil (and harness) from the unit.
- 6 To install the expansion valve coil, see "4.5.2 Repair procedures" [▶ 89].

To remove the expansion valve body

Prerequisite: Recuperate the refrigerant from the refrigerant circuit, see "5.2.2 Repair procedures" [▶ 219].

Prerequisite: If needed, remove any parts or insulation to create more space for the removal.

- 1 Remove the expansion valve coil, see "4.5.2 Repair procedures" [▶ 89].
- 2 Remove the putty. Keep for re-use.

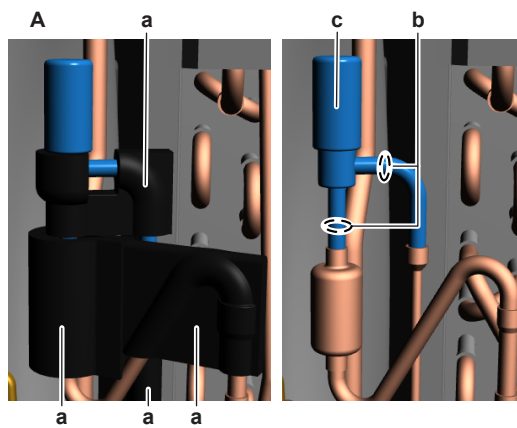

- A Class 20~35 unit
- a Putty
- b Expansion valve pipe
- c Expansion valve body

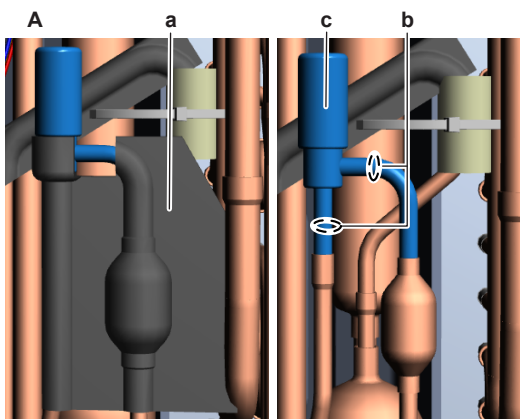

- A Class 42~71 unit
- a Putty
- b Expansion valve pipe
- c Expansion valve body

- 3 Using a valve magnet, open the expansion valve.
- 4 Supply nitrogen to the refrigerant circuit. The nitrogen pressure MUST NOT exceed 0.02 MPa.
- 5 Wrap a wet rag around the components near the expansion valve pipes. Heat the brazing points of the expansion valve pipes using an oxygen acetylene torch and remove the expansion valve pipes from the refrigerant pipes using pliers.
- 6 Stop the nitrogen supply when the piping has cooled down.
- 7 Remove the expansion valve body.



INFORMATION

It is ALSO possible to cut the component pipe(s) using a pipe cutter. Make sure to remove the remaining component pipe end(s) from the refrigerant pipes by heating the brazing point(s) of the component pipe(s) using an oxygen acetylene torch.

- 8 Install plugs or caps on the open pipe ends of the refrigerant piping to avoid dirt or impurities from entering the piping.
- 9 To install the expansion valve body, see "[4.5.2 Repair procedures](#)" [▶ 89].

To install the expansion valve body

- 1 Remove the plugs or caps from the refrigerant piping and make sure they are clean.
- 2 Remove the expansion valve coil from the spare part expansion valve body.
- 3 Install the expansion valve body in the correct location and correctly oriented. Insert the pipe ends in the pipe expansions.
- 4 Open the expansion valve using a valve magnet.
- 5 Supply nitrogen to the refrigerant circuit. The nitrogen pressure MUST NOT exceed 0.02 MPa.
- 6 Wrap a wet rag around the expansion valve body and any other components near the expansion valve and solder the expansion valve pipes to the refrigerant pipes.



CAUTION

Overheating the valve will damage or destroy it.

- 7 After soldering is done, stop the nitrogen supply after the component has cooled-down.

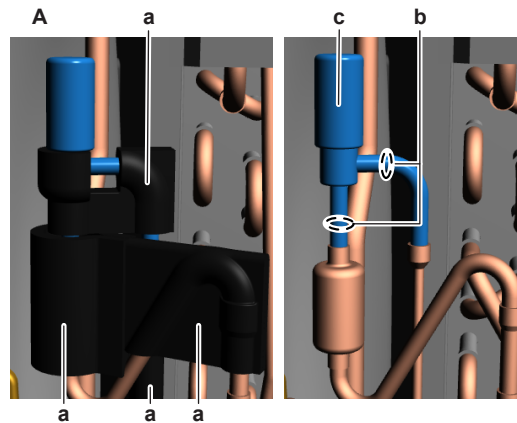

- A Class 20~35 unit
- a Putty
- b Expansion valve pipe
- c Expansion valve body

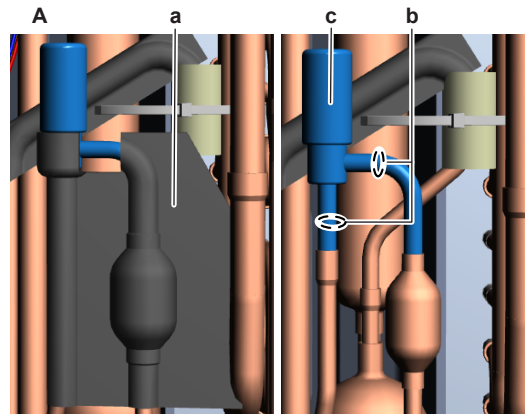

- A Class 42~71 unit
- a Putty
- b Expansion valve pipe
- c Expansion valve body

- 8 Reinstall the putty.
- 9 To install the expansion valve coil, see ["4.5.2 Repair procedures"](#) [▶ 89].
- 10 Perform a pressure test, see ["5.2.1 Checking procedures"](#) [▶ 214].
- 11 Add refrigerant to the refrigerant circuit, see ["5.2.2 Repair procedures"](#) [▶ 219].

To install the expansion valve coil with clip

- 1 Install the expansion valve coil on the expansion valve body.



INFORMATION

The expansion valve coil is equipped with a pipe retention clip. Install the pipe retention clip over the pipe to lock the expansion valve coil.

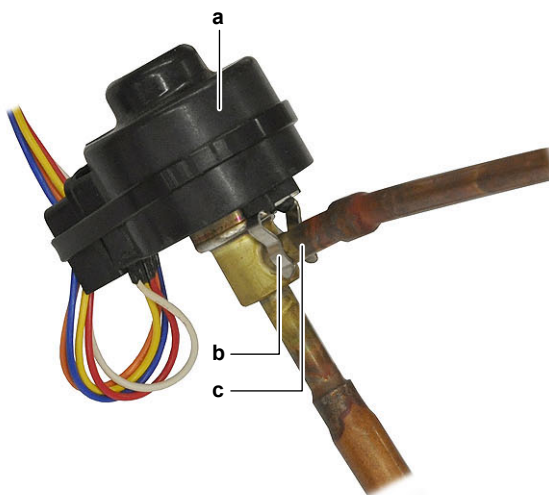

- a Expansion valve coil
- b Pipe retention clip
- c Pipe

- 2 Route the expansion valve coil harness towards the appropriate PCB.
- 3 Connect the expansion valve coil connector to the appropriate PCB.

**WARNING**

When reconnecting a connector to the PCB, make sure to connect it on the correct location and do NOT apply force, as this may damage the connector or connector pins of the PCB.

- 4 Fix the expansion valve coil harness using new tie straps.
- 5 Install the insulation cap on the expansion valve coil (if applicable).

Is the problem solved?	Action
Yes	No further actions required.
No	Return to "4.5.1 Checking procedures" [▶ 85] of the expansion valve and continue with the next procedure.

4.6 High pressure switch

4.6.1 Checking procedures

To perform an electrical check of the high pressure switch

Prerequisite: Stop the unit operation via the user interface.

Prerequisite: Turn OFF the respective circuit breaker.

Prerequisite: Remove the required plate work, see ["4.14 Plate work"](#) [▶ 157].

- 1 Recuperate the refrigerant from the refrigerant circuit, see ["5.2.2 Repair procedures"](#) [▶ 219].
- 2 Fill the refrigerant circuit with nitrogen until pressurized just below operating pressure of the high pressure switch.

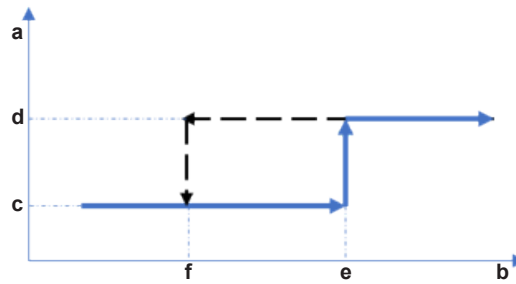

- a High pressure switch protection control
- b Pressure
- c High pressure switch closed
- d High pressure switch open
- e High pressure switch operating pressure
- f High pressure switch reset pressure

High pressure switch	Operating pressure (MPa)	Reset pressure (MPa)
S1PH	4.03~4.15	3.05~3.35

3 Disconnect the Faston connectors from the high pressure switch.



INFORMATION

Measure the continuity of all wiring between the high pressure switch and the appropriate PCB. If NO continuity is measured, repair as needed, see "7.2 Wiring diagram" [▶ 235].

4 Measure the resistance between the Faston connections of the high pressure switch.

Result: The switch MUST be closed.

5 Fill the refrigerant circuit with nitrogen until pressurized just above operating pressure of the high pressure switch.

6 Measure the resistance between the Faston connections of the high pressure switch.

Result: The switch MUST be open.



INFORMATION

If the high pressure switch was triggered open, it will stay open until the refrigerant pressure drops below the reset pressure of the high pressure switch.

7 Lower the pressure of the nitrogen in the refrigerant circuit just above reset pressure of the high pressure switch.

8 Measure the resistance between the Faston connections of the high pressure switch.

Result: The switch MUST be open.

9 Lower the pressure of the nitrogen in the refrigerant circuit just below reset pressure of the high pressure switch.

10 Measure the resistance between the Faston connections of the high pressure switch.

Result: The switch MUST be closed.

High pressure switch connector measurements are correct?	Then
Yes	High pressure switch is OK. Return to the troubleshooting of the specific error and continue with the next procedure.
No	Replace the high pressure switch, see "4.6.2 Repair procedures" [▶ 95].

4.6.2 Repair procedures

To remove the high pressure switch

Prerequisite: Stop the unit operation via the user interface.

Prerequisite: Turn OFF the respective circuit breaker.

Prerequisite: Remove the required plate work, see ["4.14 Plate work"](#) [▶ 157].

Prerequisite: Recuperate the refrigerant from the refrigerant circuit, see ["5.2.2 Repair procedures"](#) [▶ 219].

- 1 If needed, remove any parts to create more space for the removal of the high pressure switch.
- 2 Remove the compressor insulation, see ["4.2.2 Repair procedures"](#) [▶ 67].
- 3 Disconnect the Faston connectors from the high pressure switch.
- 4 Supply nitrogen to the refrigerant circuit. The nitrogen pressure MUST NOT exceed 0.02 MPa.
- 5 Wrap a wet rag around the components near the high pressure switch. Heat the brazing point of the high pressure switch pipe using an oxygen acetylene torch and remove the high pressure switch pipe from the refrigerant pipe using pliers.

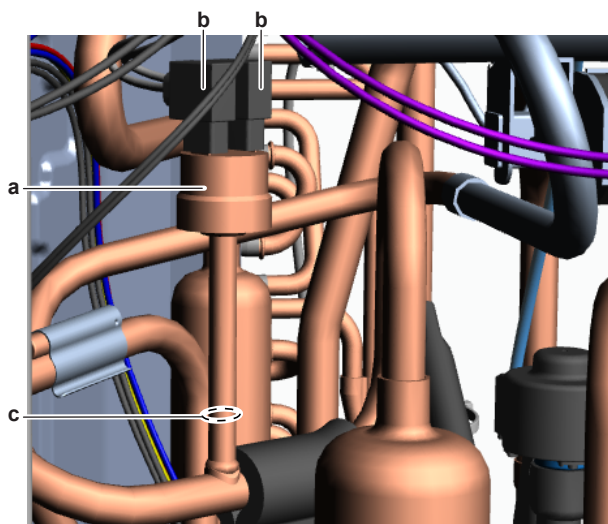

- a High pressure switch
- b Faston connector
- c High pressure switch pipe

- 6 Stop the nitrogen supply when the piping has cooled down.
- 7 Remove the high pressure switch.



INFORMATION

It is ALSO possible to cut the component pipe(s) using a pipe cutter. Make sure to remove the remaining component pipe end(s) from the refrigerant pipes by heating the brazing point(s) of the component pipe(s) using an oxygen acetylene torch.

- 8 Install a plug or cap on the refrigerant piping to avoid dirt or impurities from entering the piping.
- 9 To install the high pressure switch, see "[4.6.2 Repair procedures](#)" [▶ 95].

To install the high pressure switch

- 1 Remove the plug or cap from the refrigerant piping and make sure it is clean.
- 2 Install the high pressure switch in the correct location.
- 3 Supply nitrogen to the refrigerant circuit. The nitrogen pressure MUST NOT exceed 0.02 MPa.
- 4 Wrap a wet rag around the high pressure switch and any other components near the high pressure switch and solder the high pressure switch pipe to the refrigerant pipe.

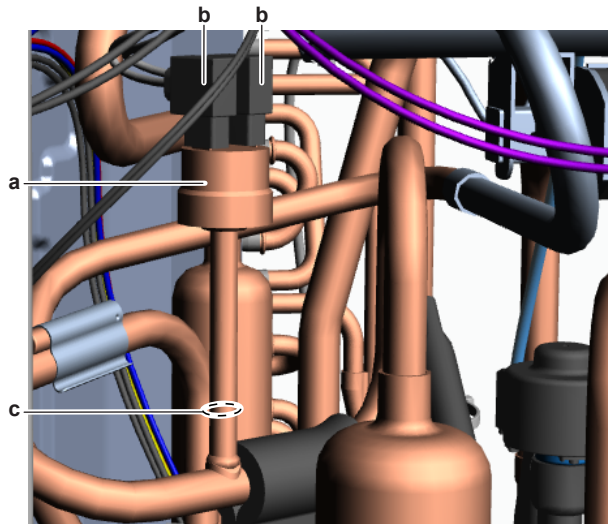

- a High pressure switch
- b Faston connector
- c High pressure switch pipe



CAUTION

Overheating the pressure switch will damage or destroy it.

- 5 After soldering is done, stop the nitrogen supply after the component has cooled-down.
- 6 Connect the Faston connectors to the high pressure switch.
- 7 Install the compressor insulation, see "[4.2.2 Repair procedures](#)" [▶ 67].
- 8 Perform a pressure test, see "[5.2.1 Checking procedures](#)" [▶ 214].
- 9 Add refrigerant to the refrigerant circuit, see "[5.2.2 Repair procedures](#)" [▶ 219].

Is the problem solved?	Action
Yes	No further actions required.

Is the problem solved?	Action
No	Return to the troubleshooting of the specific error and continue with the next procedure.

4.7 Humidity sensor

4.7.1 Checking procedures

To perform a power check of the humidity sensor

Prerequisite: Stop the unit operation via the user interface.

Prerequisite: Turn OFF the respective circuit breaker.

- 1 Remove the required plate work, see "4.14 Plate work" [▶ 157].
- 2 Turn ON the power of the unit.
- 3 Measure the power supply voltage between the pins 1-4 on the humidity sensor connector CN.

Result: The measured voltage MUST be 5 V DC.

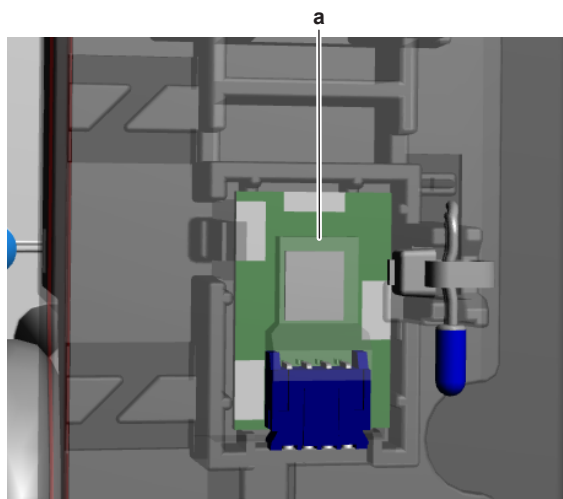

a Humidity sensor (PCB)

Is the measured power supply voltage correct?	Action
Yes	Skip the next step..
No	Continue with the next step.

- 4 Measure the output voltage between between the pins 1-4 on the connector S600 on the indoor unit main PCB.

Result: The measured voltage MUST be 5 V DC.

Is the output voltage on the indoor unit main PCB correct?	Action
Yes	Replace the humidity sensor wiring harness, see "4.7.2 Repair procedures" [▶ 98].

Is the output voltage on the indoor unit main PCB correct?	Action
No	Perform a check of the indoor unit main PCB, see "4.9.1 Checking procedures" [▶ 110].

- 5** As there are no further check procedures for this component, perform a check of the indoor unit main PCB to check if the humidity sensor needs to be replaced. See ["4.9.1 Checking procedures"](#) [▶ 110].

After complete check of the indoor unit main PCB, is the problem solved?	Action
Yes	No further actions required.
No	Replace the humidity sensor, see "4.7.2 Repair procedures" [▶ 98].

4.7.2 Repair procedures

To remove the humidity sensor

Prerequisite: Stop the unit operation via the user interface.

Prerequisite: Turn OFF the respective circuit breaker.

Prerequisite: Remove the required plate work, see ["4.14 Plate work"](#) [▶ 157].

- 1 Disconnect the connector from the humidity sensor PCB.
- 2 Cut the tie strap that fixes the thermistor.
- 3 Carefully click the complete humidity sensor PCB assembly out of the indoor unit.

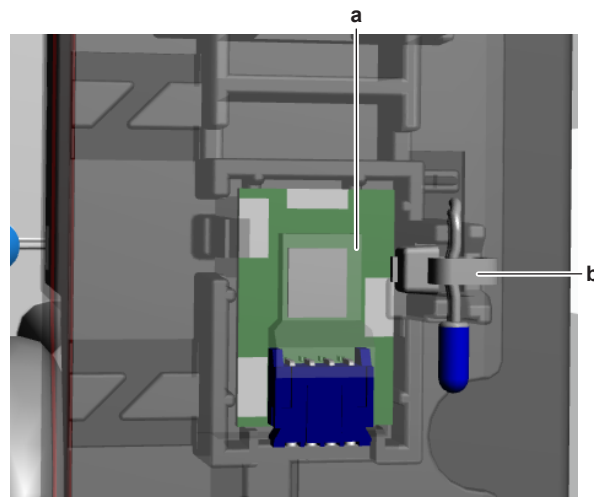

a Humidity sensor PCB assembly
b Tie strap (thermistor fixation)

- 4 To install the humidity sensor PCB assembly, see ["4.7.2 Repair procedures"](#) [▶ 98].

To install the humidity sensor

- 1 Click the humidity sensor PCB assembly on the indoor unit.

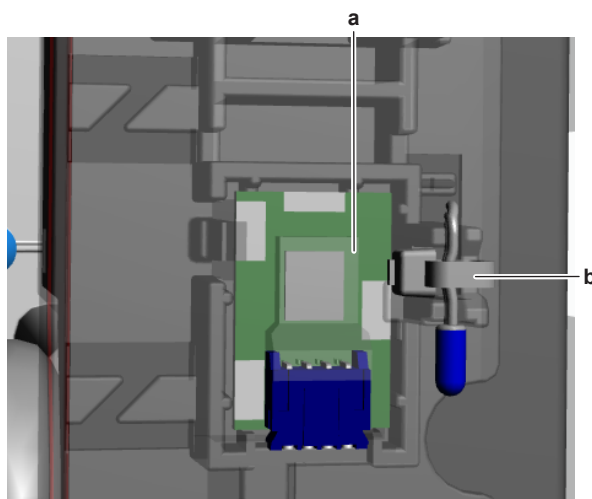

- a** Humidity sensor PCB assembly
b Tie strap (thermistor fixation)

- 2 Install the thermistor on the correct location and fix it to the bracket using a new tie strap.
- 3 Connect the harness to the humidity sensor PCB assembly.

Is the problem solved?	Action
Yes	No further actions required.
No	Return to the troubleshooting of the specific error and continue with the next procedure.

To remove the humidity sensor wiring harness

Prerequisite: Stop the unit operation via the user interface.

Prerequisite: Turn OFF the respective circuit breaker.

Prerequisite: Remove the required plate work, see "[4.14 Plate work](#)" [▶ 157].

- 1 Disconnect the wiring harness from the humidity sensor (PCB).
- 2 Disconnect the wiring harness connector from the indoor unit main PCB.
- 3 Cut all tie straps (if any) that fix the wiring harness.
- 4 Route the wiring harness out of the harness retainers and remove the humidity sensor wiring harness.
- 5 To install the humidity sensor wiring harness, see "[4.7.2 Repair procedures](#)" [▶ 98].

To install the humidity sensor wiring harness

- 1 Connect the wiring harness connector to the indoor unit main PCB.



WARNING

When reconnecting a connector to the PCB, make sure to connect it on the correct location and do NOT apply force, as this may damage the connector or connector pins of the PCB.

- 2 Route the wiring harness through the appropriate harness retainers towards the humidity sensor (PCB).
- 3 Connect the wiring harness to the humidity sensor (PCB).
- 4 Fix the wiring harness using new tie straps (if needed).

Is the problem solved?	Action
Yes	No further actions required.
No	Return to the troubleshooting of the specific error and continue with the next procedure.

4.8 Indoor unit fan motor

4.8.1 Wall mounted indoor units

Checking procedures



INFORMATION

It is recommended to perform the checks in the listed order.

To perform a mechanical check of the DC fan motor assembly

Prerequisite: Stop the unit operation via the user interface.

Prerequisite: Turn OFF the respective circuit breaker.

Prerequisite: Remove the required plate work, see ["4.14 Plate work"](#) [▶ 157].

- 1 Check the fan for damage, deformations and cracks. Replace the fan as needed.
- 2 Check that the fan is correctly installed on the DC fan motor. Correct as needed.
- 3 Manually rotate the fan and check the friction of the DC fan motor shaft bearing.

Is the DC fan motor shaft friction normal?	Action
Yes	Perform an electrical check of the DC fan motor assembly, see "Checking procedures" [▶ 100].
No	Replace the DC fan motor assembly, see "Repair procedures" [▶ 101].

To perform an electrical check of the DC fan motor assembly

Prerequisite: First perform a mechanical check of the DC fan motor assembly, see ["Checking procedures"](#) [▶ 100].

- 1 Remove the cover from the switch box; see ["4.14 Plate work"](#) [▶ 157].
- 2 Disconnect the DC fan motor connector from the appropriate PCB.
- 3 Measure the resistance between the pins 1-2, 1-3, and 2-3 of the DC fan motor connector.

Result: All measurements MUST be approximately the same.

DC fan motor measurements are correct?	Action
Yes	Return to the troubleshooting of the specific error and continue with the next procedure.

DC fan motor measurements are correct?	Action
No	Replace the DC fan motor, see " Repair procedures " [▶ 101].

Repair procedures

To remove the DC fan motor assembly

Prerequisite: Stop the unit operation via the user interface.

Prerequisite: Turn OFF the respective circuit breaker.

Prerequisite: Remove the required plate work, see "[4.14 Plate work](#)" [▶ 157].

- 1 Remove the switch box, see "[4.14 Plate work](#)" [▶ 157].
- 2 Click the indoor unit fan motor cover out of the indoor unit. If needed, remove the screw (if installed) on the right hand side of the fan motor cover for easier removal.

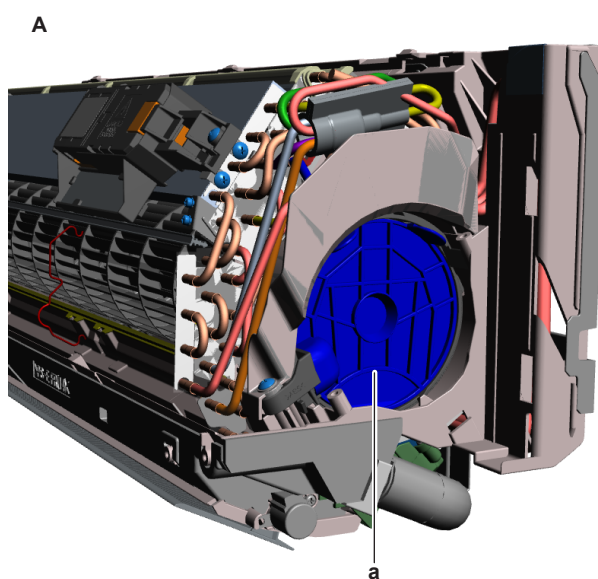

A Class 20~42 unit
a Indoor unit fan motor cover

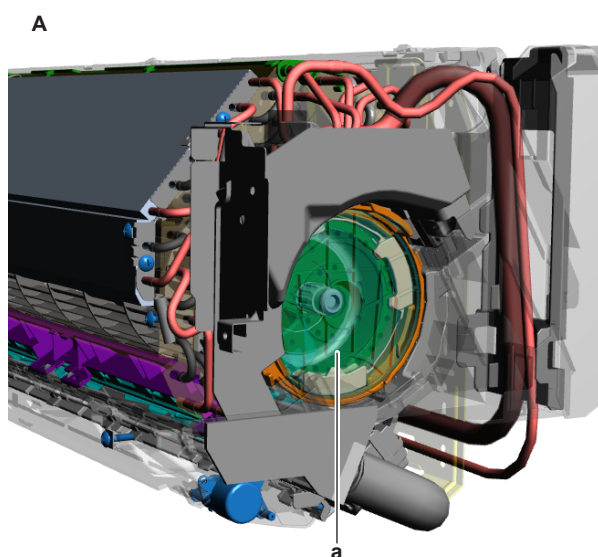

A Class 50~71 unit
a Indoor unit fan motor cover

- 3 Remove the rubber from the indoor unit.

- 4 Remove the indoor unit fan motor from the indoor unit.
- 5 To install the indoor unit fan motor, see "[Repair procedures](#)" [▶ 101].

To install the DC fan motor assembly

- 1 Install the indoor unit fan motor in its correct location on the fan.
- 2 Install the rubber in front of the fan motor.
- 3 Click the indoor unit fan motor cover on the indoor unit. If removed, install and tighten the screw on the right hand side of the fan motor cover.

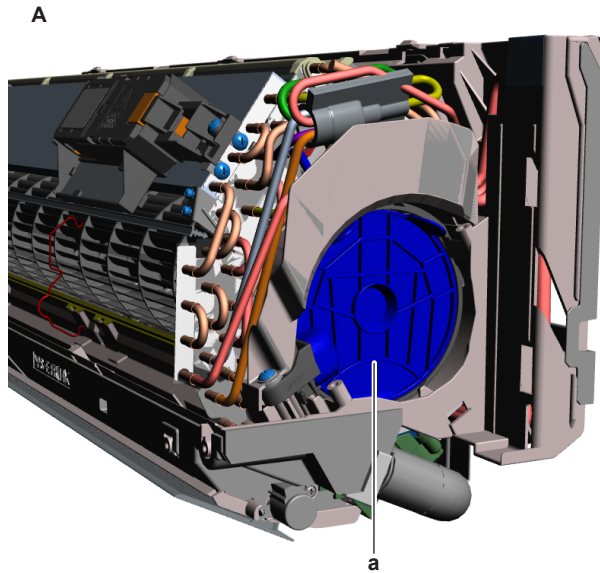

A Class 20~42 unit
a Indoor unit fan motor cover

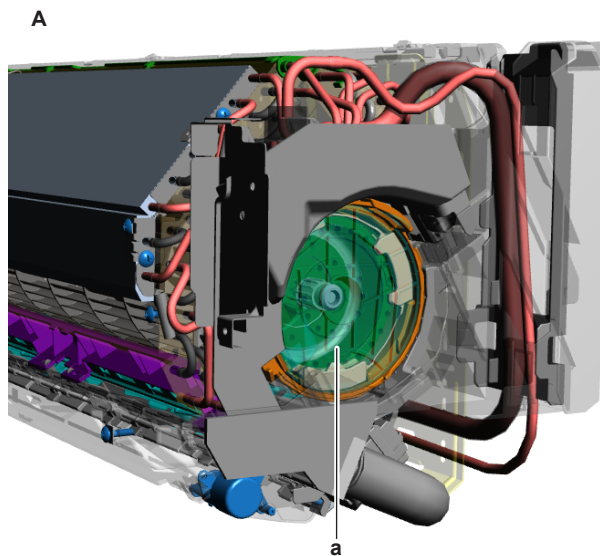

A Class 50~71 unit
a Indoor unit fan motor cover

- 4 Install the switch box, see "[4.14 Plate work](#)" [▶ 157].

Is the problem solved?	Action
Yes	No further actions required.
No	Return to the troubleshooting of the specific error and continue with the next procedure.

4.8.2 Floor standing indoor units

Checking procedures

**INFORMATION**

It is recommended to perform the checks in the listed order.

To perform a mechanical check of the turbo fan assembly

Prerequisite: Stop the unit operation via the user interface.

Prerequisite: Turn OFF the respective circuit breaker.

Prerequisite: Remove the required plate work, see ["4.14 Plate work"](#) [▶ 157].

- 1 Remove the swing flap (by clicking it out).
- 2 Remove the air outlet protection net to create access to the turbo fan.

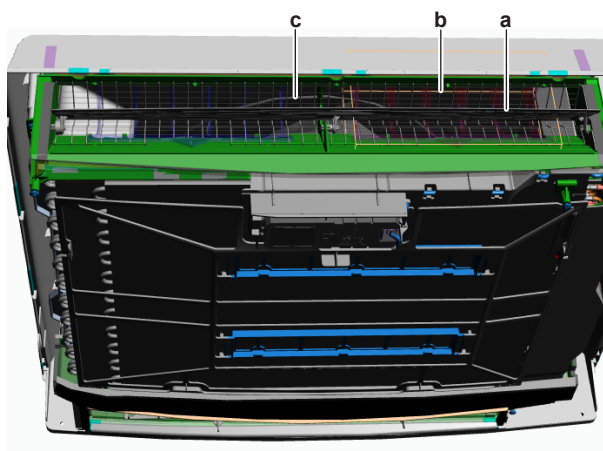

- a Swing flap
- b Air outlet protection net
- c Turbo fan

- 3 Slowly rotate the turbo fan using a long-length tool.
- 4 If the turbo fan touches the bellmouth, check if the fan motor is correctly mounted on its base, see ["Repair procedures"](#) [▶ 104].
- 5 Check the state of the turbo fan assembly for damage, deformations and cracks.

Is the turbo fan assembly damaged?	Action
Yes	Replace the turbo fan assembly, see "Repair procedures" [▶ 104].
No	Perform a mechanical check of the DC fan motor assembly, see "Checking procedures" [▶ 103].

To perform a mechanical check of the DC fan motor assembly

Prerequisite: First perform a mechanical check of the propeller fan blade assembly, see ["Checking procedures"](#) [▶ 103].

- 1 Slowly rotate the turbo fan using a long-length tool. Check that it rotates smoothly.
- 2 Check the friction of the DC fan motor shaft bearing.

Is the DC fan motor shaft friction normal?	Action
Yes	Perform an electrical check of the DC fan motor assembly, see " Checking procedures " [▶ 103].
No	Replace the DC fan motor assembly, see " Repair procedures " [▶ 104].

To perform an electrical check of the DC fan motor assembly

- 1 First perform a mechanical check of the DC fan motor assembly, see "[Checking procedures](#)" [▶ 103].
- 2 Turn ON the power of the unit.
- 3 Activate **Cooling** or **Heating** operation via the user interface.
- 4 Check the functioning of the turbo fan.

Turbo fan ...	Action
Rotates continuously (without interruption)	DC fan motor assembly is OK. Return to the troubleshooting of the specific error and continue with the next procedure.
Does not rotate or rotates for a short time	Continue with the next step.

- 5 Turn OFF the unit via the user interface.
- 6 Turn OFF the respective circuit breaker.



DANGER: RISK OF ELECTROCUTION

Wait for at least 10 minutes after the circuit breaker has been turned OFF, to be sure the rectifier voltage is below 10 V DC before proceeding.

- 7 Check that the DC fan motor connector is properly connected to the indoor unit main PCB.
- 8 Unplug the DC fan motor connector and measure the resistance between the pins 1-2, 1-3, and 2-3 of the DC fan motor connector.
Result: All measurements MUST be 84.9~97.7 Ω.
- 9 Set the Megger voltage to 500 V DC or 1000 V DC.
- 10 Measure the insulation resistance for the motor terminals. Measurements between each phase and fan motor body (e.g. axle) MUST be >1000 MΩ.

Are the measured resistance values correct?	Action
Yes	Perform a check of the indoor unit main PCB, see " 4.9.1 Checking procedures " [▶ 110].
No	Replace the DC fan motor, see " Repair procedures " [▶ 104].

Repair procedures

To remove the turbo fan assembly

Prerequisite: First perform pump down operation. Close the refrigerant circuit stop valves when done.

Prerequisite: Stop the unit operation via the user interface.

Prerequisite: Turn OFF the respective circuit breaker.

- 1 Remove the required plate work, see "4.14 Plate work" [▶ 157].
- 2 Remove the switch box, see "4.14 Plate work" [▶ 157].
- 3 Remove the 2 screws and remove the upper air outlet assembly.

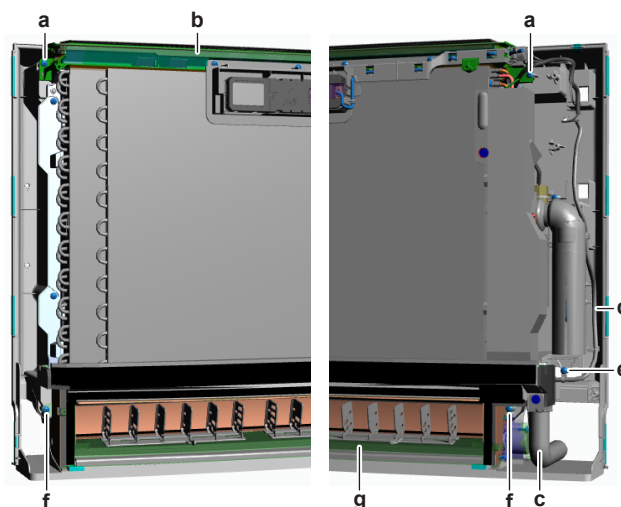

- a Screw (upper air outlet assy)
- b Upper air outlet assy
- c Drain hose
- d Damper motor wiring harness
- e Screw (tie strap)
- f Screw (lower air outlet assy)
- g Lower air outlet assy

- 4 Put a small drain pan (or container) under the drain hose.
- 5 Remove the screw from the fixation bracket and pull the drain hose downwards to remove it from the indoor unit.
- 6 Route the damper motor wiring harness out of the harness retainers and remove the screw to disconnect the tie strap from the unit.
- 7 Remove the 2 screws and remove the lower air outlet assembly.
- 8 Remove the screw and remove the plate from the indoor unit heat exchanger.

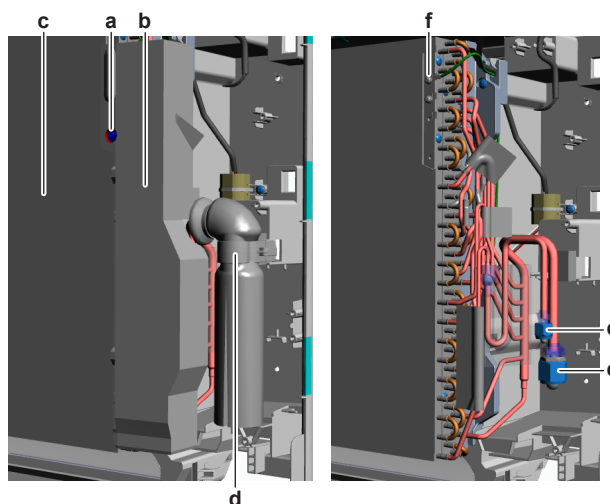

- a Screw (plate)
- b Plate
- c Indoor unit heat exchanger
- d Piping fixture
- e Flared joint
- f Screw (ground wire)

- 9 Release the 2 hooks and remove the piping fixture.
- 10 Release the flared joint of the (refrigerant) liquid pipe and the gas pipe. Disconnect the liquid and gas pipes from the refrigerant field piping. Plug the refrigerant field pipes to prevent dirt from entering the pipes.
- 11 Remove the screw and disconnect the ground wire from the indoor unit heat exchanger.
- 12 Unfasten the 2 hooks on the left side of the indoor heat exchanger.

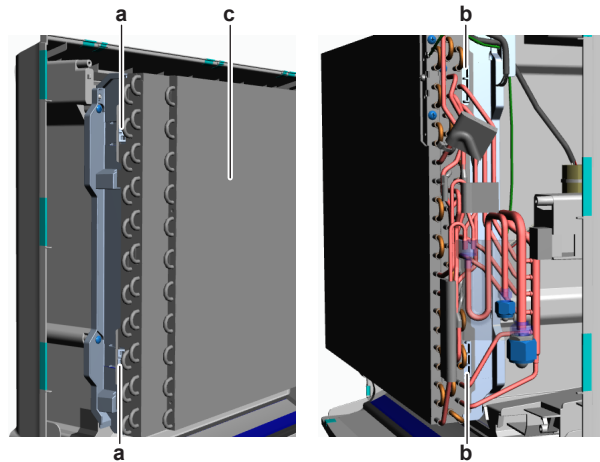

- a Hook (left side)
- b Hook (right side)
- c Indoor unit heat exchanger

- 13 Unfasten the 2 hooks on the right side of the indoor heat exchanger and remove the indoor unit heat exchanger.
- 14 Remove the 4 screws and remove the bellmouth from the indoor unit.

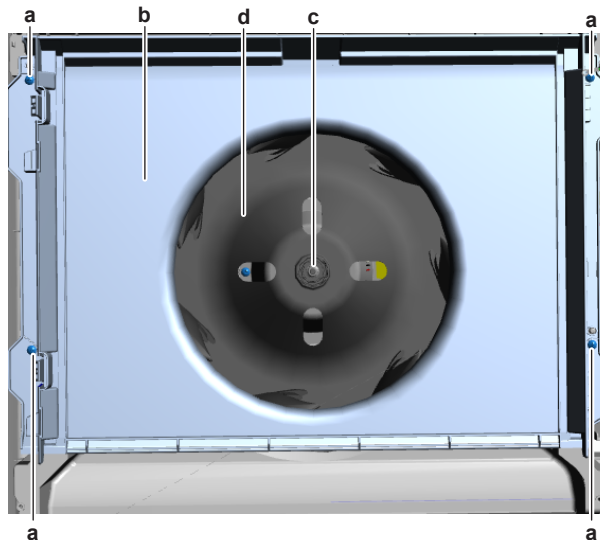

- a Screw (bellmouth)
- b Bellmouth
- c Nut (turbo fan assy)
- d Turbo fan assy

- 15 Remove the nut that fixes the turbo fan assembly.
- 16 Pull and remove the turbo fan assembly from the DC fan motor assembly.



INFORMATION

Use a pulley remover if the propeller cannot be removed manually.

17 To install the turbo fan assembly, see ["Repair procedures"](#) [▶ 104].

To remove the DC fan motor assembly

- 1** Remove the turbo fan assembly from the DC fan motor assembly, see ["Repair procedures"](#) [▶ 104].
- 2** Cut the tie strap and unlock the ferrite core.

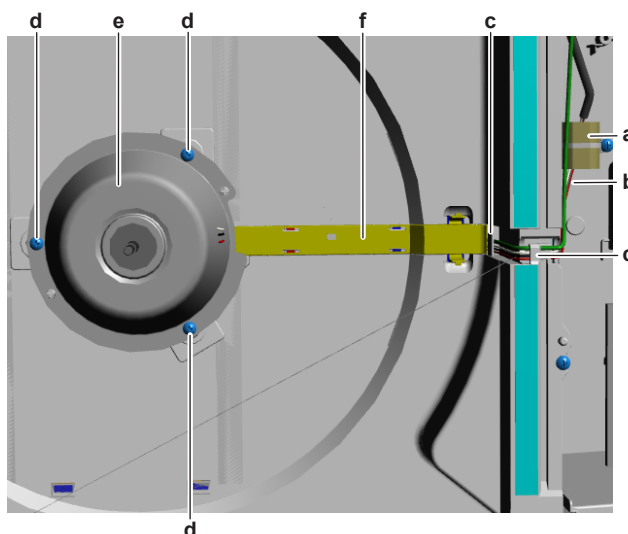

- a** Ferrite core
- b** DC fan motor wiring harness
- c** Hook
- d** Screw (fan motor cover)
- e** Fan motor cover
- f** Wiring harness retainer

- 3** Route the DC fan motor wiring harness out of the hooks.
- 4** Remove the 3 screws and remove the fan motor cover.
- 5** Unfasten the hooks and remove the wiring harness retainer.
- 6** Route the DC fan motor wiring harness out of the hooks (behind the harness retainer).
- 7** Remove the DC fan motor assembly from the indoor unit.
- 8** To install the DC fan motor assembly, see ["Repair procedures"](#) [▶ 104].

To install the DC fan motor assembly

- 1** Install the DC fan motor assembly on the fan motor cover.
- 2** Install the fan motor cover with DC fan motor assembly on the correct location.
- 3** Install and tighten the 3 screws to fix the fan motor cover.

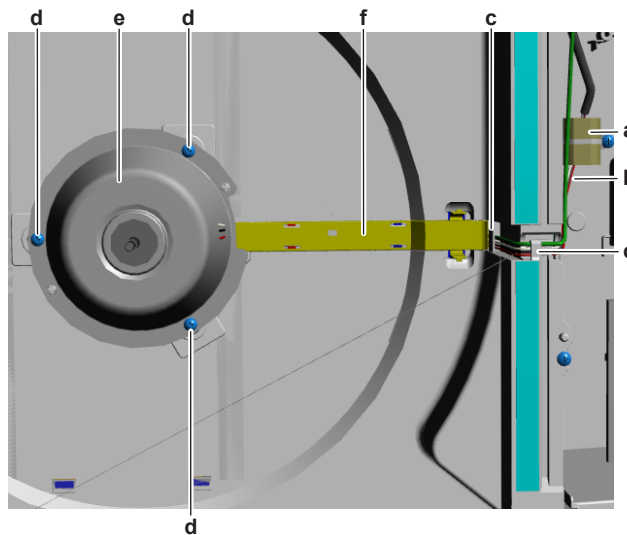

- a Ferrite core
- b DC fan motor wiring harness
- c Hook
- d Screw (fan motor cover)
- e Fan motor cover
- f Wiring harness retainer

- 4 Route the DC fan motor wiring harness through the hooks and install the harness retainer. Make sure the wiring harness is also routed through the hooks located behind the harness retainer.
- 5 Lock the ferrite core on the DC fan motor wiring harness.
- 6 Install a new tie strap to fix the ferrite core to the indoor unit.
- 7 Install the turbo fan assembly, see "[Repair procedures](#)" [▶ 104].

To install the turbo fan assembly

- 1 Install the turbo fan assembly on the DC fan motor assembly.



CAUTION
Do NOT install a damaged turbo fan assembly.

- 2 Install and tighten the nut to fix the turbo fan assembly.

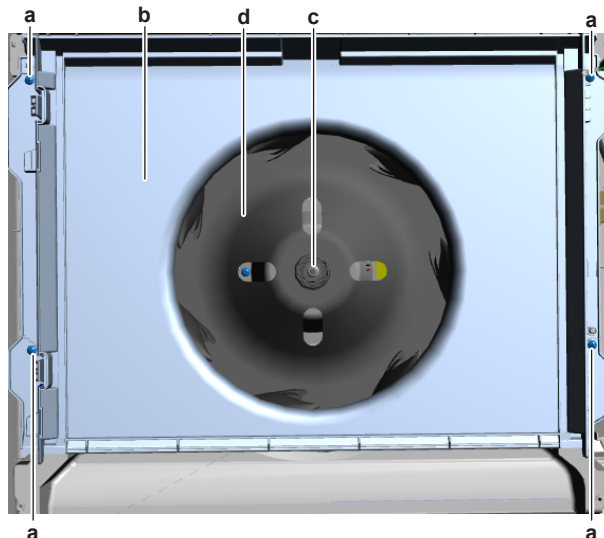

- a Screw (bellmouth)
- b Bellmouth
- c Nut (turbo fan assy)
- d Turbo fan assy

- 3 Install the bellmouth in the correct location on the indoor unit. Install and tighten the 4 screws to fix the bellmouth.
- 4 Slowly rotate the turbo fan and check that it does NOT touch the bellmouth. Repair as needed.
- 5 Install the indoor unit heat exchanger on the 2 hooks on the right side.

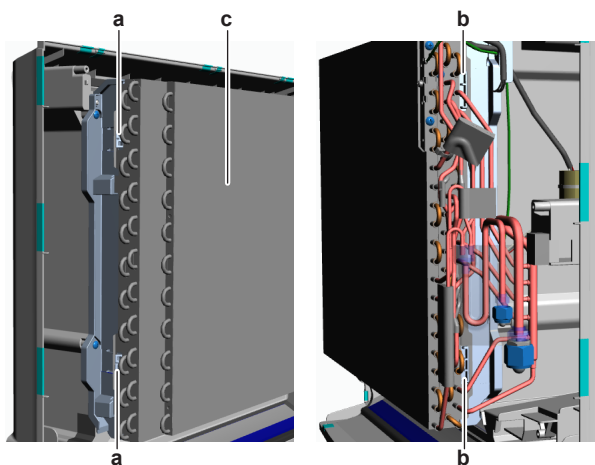

- a Hook (left side)
- b Hook (right side)
- c Indoor unit heat exchanger

- 6 Route the fan motor ground wire in front of the indoor unit heat exchanger.
- 7 Carefully move the indoor unit heat exchanger to the correct position and install it on the 2 hooks on the left side.
- 8 Connect the ground wire to the indoor unit heat exchanger using the screw.

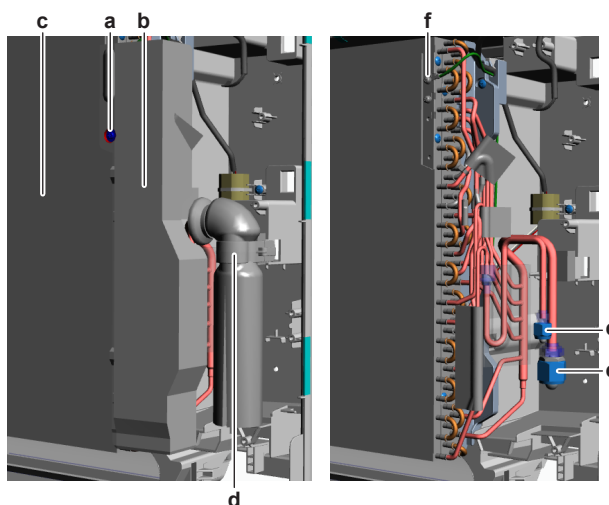

- a Screw (plate)
- b Plate
- c Indoor unit heat exchanger
- d Piping fixture
- e Flared joint
- f Screw (ground wire)

- 9 Make sure that the refrigerant field piping connections are clean and not damaged. Remove the caps and properly connect the field piping to the liquid and gas pipes of the indoor unit. Tighten the flared joints.
- 10 Correctly install the insulation on the liquid and gas pipes. Install the piping fixture.
- 11 Install the plate in the correct location on the indoor unit heat exchanger. Install and tighten the screw to fix the plate.

- 12** Install the lower air outlet assembly in the correct location. Install and tighten the 2 screws.

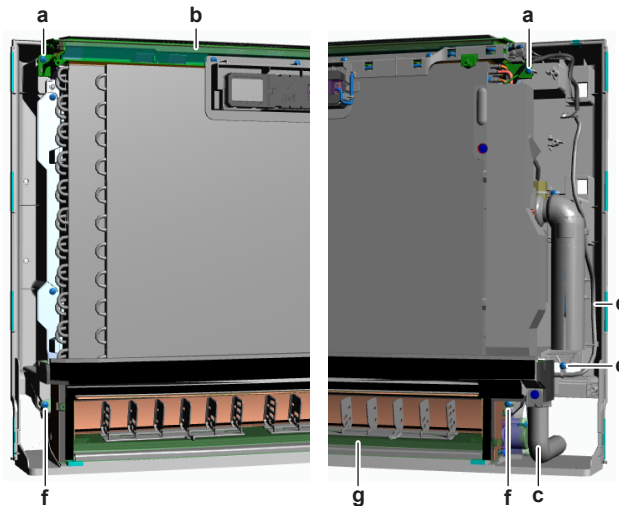

- a Screw (upper air outlet assy)
- b Upper air outlet assy
- c Drain hose
- d Damper motor wiring harness
- e Screw (tie strap)
- f Screw (lower air outlet assy)
- g Lower air outlet assy

- 13** Route the damper motor wiring harness through the appropriate harness retainers.
- 14** Install the screw to connect the tie strap to the unit.
- 15** Connect the drain hose to the lower air outlet assembly.
- 16** Install the drain hose fixation bracket. Install and tighten the screw.
- 17** Install the upper air outlet assembly in the correct location. Install and tighten the 2 screws.
- 18** Install the switch box, see ["4.14 Plate work"](#) [▶ 157].
- 19** Perform a pressure test on the piping of the indoor unit and vacuum. Open the stop valves when done.
- 20** Add refrigerant to the refrigerant circuit, see ["5.2.2 Repair procedures"](#) [▶ 219].

Is the problem solved?	Action
Yes	No further actions required.
No	Return to "Checking procedures" [▶ 103] of the indoor unit fan motor and continue with the next procedure.

4.9 Indoor unit main PCB

4.9.1 Checking procedures



INFORMATION

It is recommended to perform the checks in the listed order.

To perform a power check of the indoor unit main PCB

Prerequisite: Stop the unit operation via the user interface.

Prerequisite: Turn OFF the respective circuit breaker.

Prerequisite: Remove the required plate work, see "[4.14 Plate work](#)" [▶ 157].

- 1 Turn ON the power of the unit.
- 2 Measure the voltage between the pins 1-4 of the connector S300A on the indoor unit main PCB.

Result: The measured voltage MUST be 324 V DC.

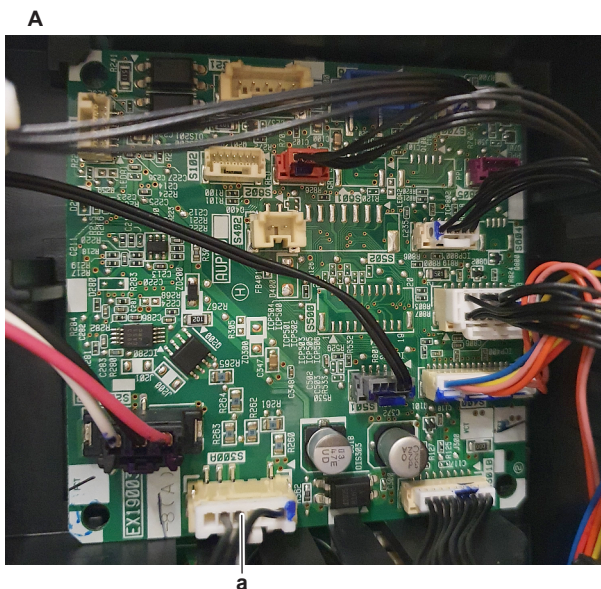

A Wall mounted indoor unit

a Connector S300A

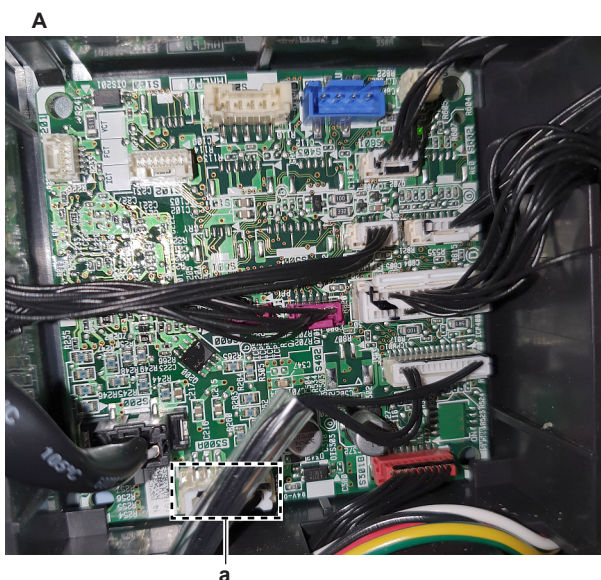

A Floor standing indoor unit

a Connector S300A

Is the measured voltage on the indoor unit main PCB correct?	Action
Yes	Return to " 4.9.1 Checking procedures " [▶ 110] of the indoor unit main PCB and continue with the next procedure.

Is the measured voltage on the indoor unit main PCB correct?	Action
No	Continue with the next step.

3 Measure the output voltage between the pins 1-4 of the connector S102 on the indoor unit power PCB.

Result: The measured voltage MUST be 324 V DC.

Output voltage on indoor unit power PCB correct?	Action
Yes	Correct the wiring between the indoor unit main PCB and indoor unit power PCB, see " 5.1.2 Repair procedures " [▶ 213].
No	Perform a check of the indoor unit power PCB, see " 4.10.1 Checking procedures " [▶ 116].

To check the HAP LED of the indoor unit main PCB

i **INFORMATION**
 HAP LED is ONLY available on the main PCB of the floor standing indoor units.

Prerequisite: First perform a power check of the indoor unit main PCB, see "[4.9.1 Checking procedures](#)" [▶ 110].

1 Locate the HAP LED on the indoor unit main PCB.

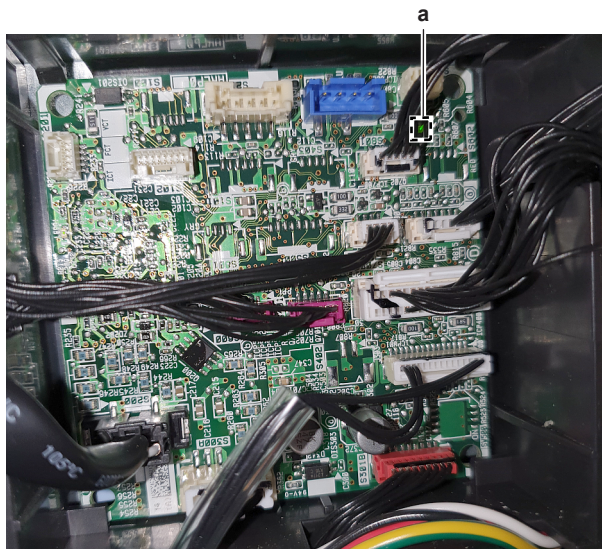

a HAP LED

i **INFORMATION**
 Make sure the correct software is available on the PCB. If NOT, update using the updater tool.

Does the HAP LED blink in regular intervals (1 second ON/1 second OFF)?	Action
Yes	Return to " 4.9.1 Checking procedures " [▶ 110] of the indoor unit main PCB and continue with the next procedure.
No	Replace the indoor unit main PCB, see " 4.9.2 Repair procedures " [▶ 114].

To check if the correct spare part is installed

Prerequisite: First perform all earlier checks of the indoor unit main PCB, see "[4.9.1 Checking procedures](#)" [▶ 110].

- 1 Visit your local spare parts webbank.
- 2 Enter the model name of your unit and check if the installed spare part number corresponds with the spare part number indicated in the webbank.

Is the correct spare part for the indoor unit main PCB installed?	Action
Yes	Return to " 4.9.1 Checking procedures " [▶ 110] of the indoor unit main PCB and continue with the next procedure.
No	Replace the indoor unit main PCB, see " 4.9.2 Repair procedures " [▶ 114].

To check the wiring of the indoor unit main PCB

Prerequisite: First perform all earlier checks of the indoor unit main PCB, see "[4.9.1 Checking procedures](#)" [▶ 110].

Prerequisite: Stop the unit operation via the user interface.

Prerequisite: Turn OFF the respective circuit breaker.

- 1 Check that all wires are properly connected and that all connectors are fully plugged-in.
- 2 Check that no connectors or wires are damaged.
- 3 Check that the wiring corresponds with the wiring diagram, see "[7.2 Wiring diagram](#)" [▶ 235].



INFORMATION

Correct the wiring as needed.

Is the problem solved?	Action
Yes	No further actions required.
No	Return to " 4.9.1 Checking procedures " [▶ 110] of the indoor unit main PCB and continue with the next procedure.

Problem solved?

After all checking procedures listed above have been performed:

Is the problem solved?	Action
Yes	No further actions required.
No	Return to the troubleshooting of the specific error and continue with the next procedure.

4.9.2 Repair procedures

To remove the indoor unit main PCB

Prerequisite: Stop the unit operation via the user interface.

Prerequisite: Turn OFF the respective circuit breaker.

Prerequisite: Remove the required plate work, see "4.14 Plate work" [▶ 157].

- 1 Disconnect all connectors from the indoor unit main PCB.
- 2 Carefully click the indoor unit main PCB out of the PCB retainers.

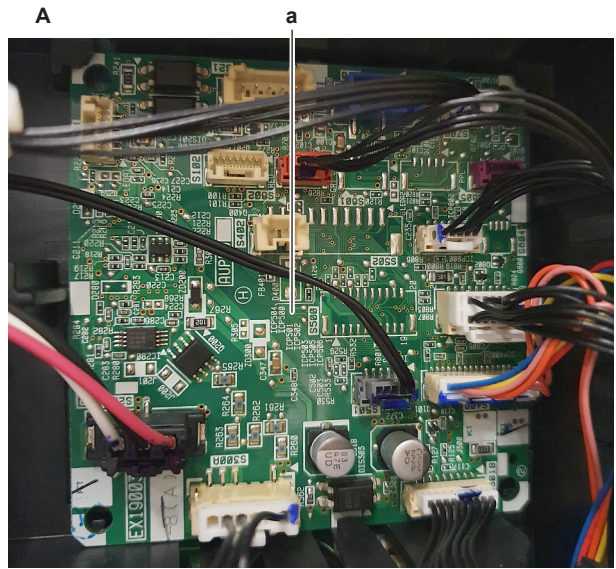

A Wall mounted indoor unit
a Indoor unit main PCB

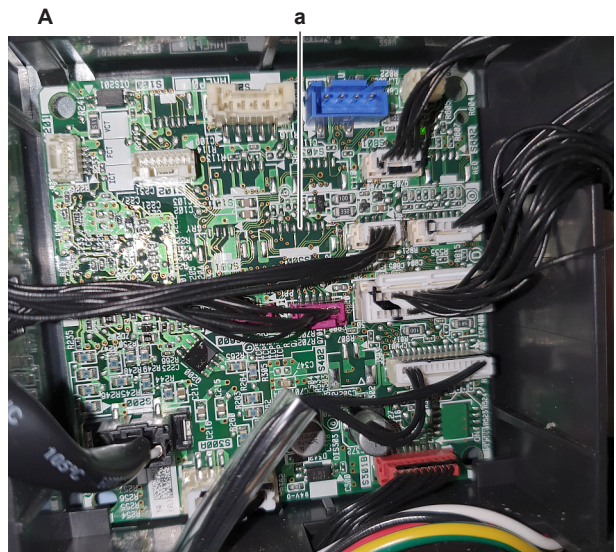

A Floor standing indoor unit
a Indoor unit main PCB

- 3 Remove the indoor unit main PCB from the indoor unit.

- 4 To install the indoor unit main PCB, see "[4.9.2 Repair procedures](#)" [[▶ 114](#)].

To install the indoor unit main PCB

- 1 Install the indoor unit main PCB in the correct location in the switch box. Make sure the PCB is correctly fixed by the PCB retainers.

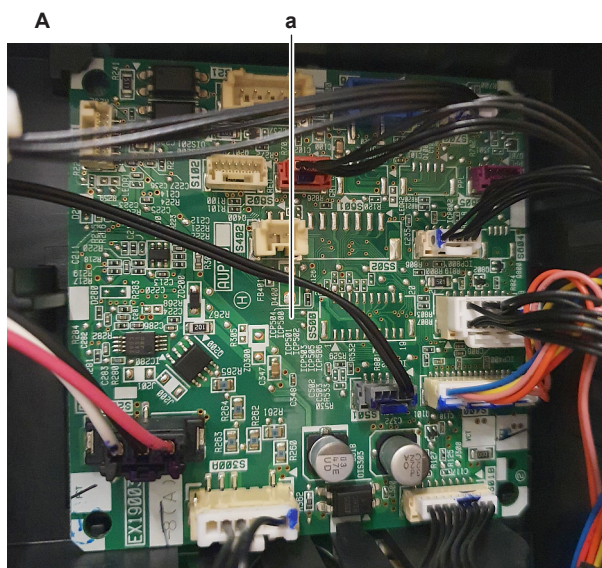

A Wall mounted indoor unit
a Indoor unit main PCB

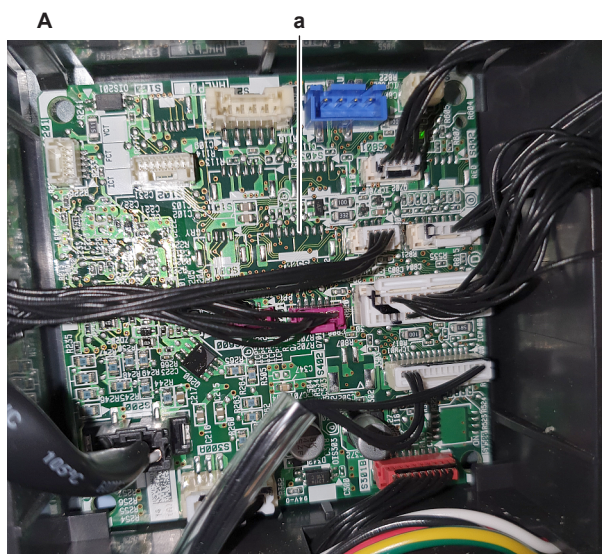

A Floor standing indoor unit
a Indoor unit main PCB

- 2 Connect all connectors to the indoor unit main PCB.



INFORMATION

Use the wiring diagram and connection diagram for correct installation of the connectors, see "[7.2 Wiring diagram](#)" [[▶ 235](#)].



WARNING

When reconnecting a connector to the PCB, make sure to connect it on the correct location and do NOT apply force, as this may damage the connector or connector pins of the PCB.

Is the problem solved?	Action
Yes	No further actions required.
No	Return to "4.9.1 Checking procedures" [▶ 110] of the indoor unit main PCB and continue with the next procedure.

4.10 Indoor unit power PCB

4.10.1 Checking procedures



INFORMATION

It is recommended to perform the checks in the listed order.

To perform a power check of the indoor unit power PCB

Prerequisite: Stop the unit operation via the user interface.

Prerequisite: Turn OFF the respective circuit breaker.

Prerequisite: Remove the required plate work, see ["4.14 Plate work"](#) [▶ 157].

- 1 Turn ON the power of the unit.
- 2 Measure the voltage between the black and white wires of connector S101 on the indoor unit power PCB.

Result: The measured voltage MUST be 230 V AC.

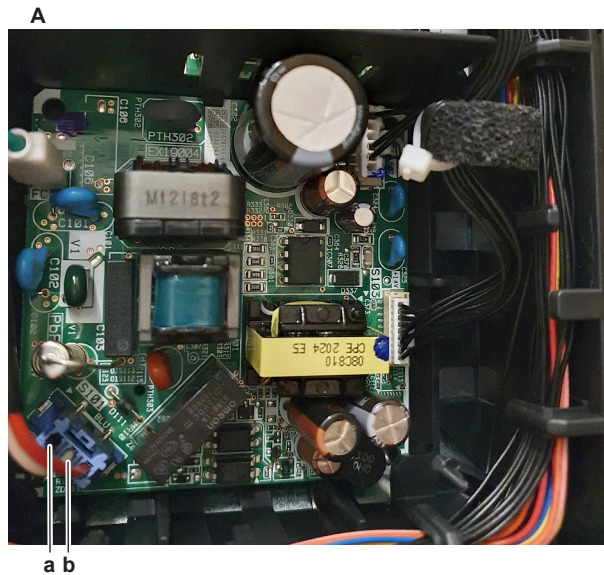

- A** Wall mounted indoor unit
a Black wire
b White wire

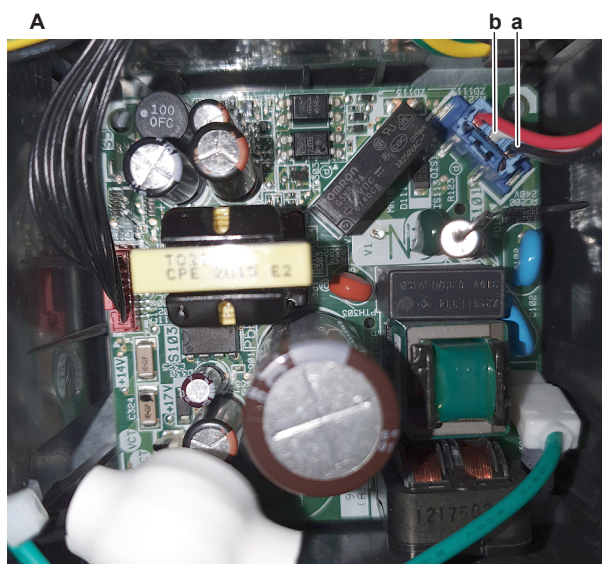

- A** Floor standing indoor unit
a Black wire
b White wire

Is the measured voltage on the indoor unit power PCB correct?	Action
Yes	Return to "4.10.1 Checking procedures" [▶ 116] of the indoor unit power PCB and continue with the next procedure.
No	Continue with the next step.

- 3** Check the power supply to the indoor unit, see ["5.1.1 Checking procedures"](#) [▶ 212].

Is the power supply to the indoor unit correct?	Action
Yes	Correct the wiring between the power supply terminal of the indoor unit and the indoor unit power PCB, see "4.10.2 Repair procedures" [▶ 121].
No	See "To check the power supply to the indoor unit" ("5.1.2 Repair procedures" [▶ 213]) for the next steps.

To perform an electrical check of the indoor unit power PCB

Prerequisite: First perform a power check of the indoor unit power PCB, see ["4.10.1 Checking procedures"](#) [▶ 116].

- 1** Measure the voltage between the pins 1-4 of the connector S102.

Result: The measured voltage MUST be 324 VDC.

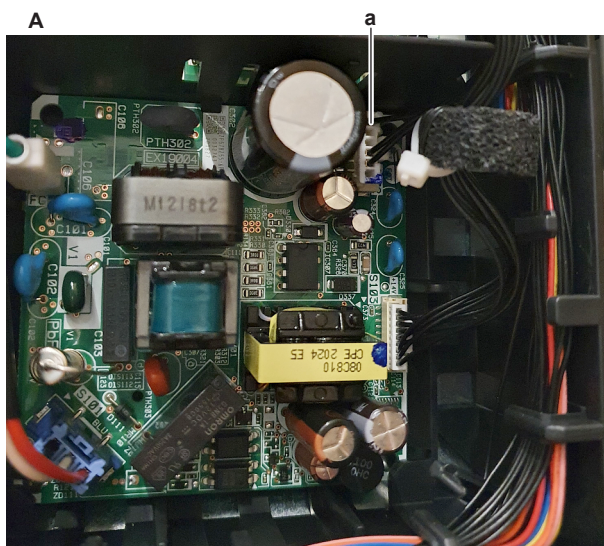

A Wall mounted indoor unit
a Connector S102

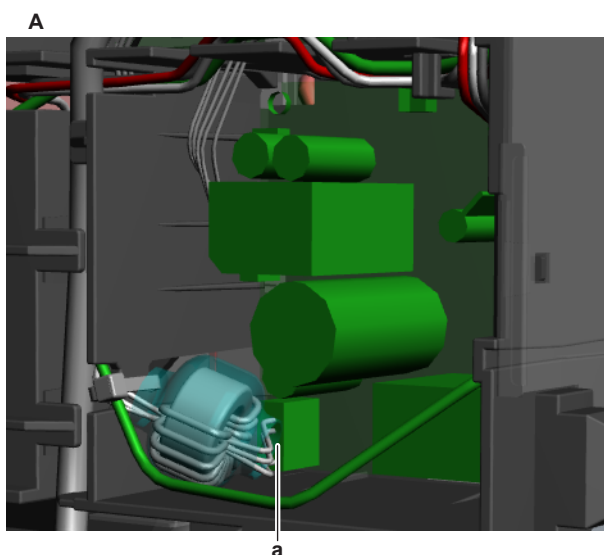

A Floor standing indoor unit
a Connector S102

Is the measured voltage on the indoor unit power PCB correct?	Action
Yes	Return to "4.10.1 Checking procedures" [▶ 116] of the indoor unit power PCB and continue with the next procedure.
No	Replace the indoor unit power PCB, see "4.10.2 Repair procedures" [▶ 121].

To check if the correct spare part is installed

Prerequisite: First perform all earlier checks of the indoor unit main PCB, see ["4.10.1 Checking procedures"](#) [▶ 116].

- 1 Visit your local spare parts webbank.
- 2 Enter the model name of your unit and check if the installed spare part number corresponds with the spare part number indicated in the webbank.

Is the correct spare part for the indoor unit power PCB installed?	Action
Yes	Return to " 4.10.1 Checking procedures " [▶ 116] of the indoor unit power PCB and continue with the next procedure.
No	Replace the indoor unit power PCB, see " 4.10.2 Repair procedures " [▶ 121].

To check the wiring of the indoor unit power PCB

Prerequisite: First perform all earlier checks of the indoor unit main PCB, see "[4.10.1 Checking procedures](#)" [▶ 116].

Prerequisite: Stop the unit operation via the user interface.

Prerequisite: Turn OFF the respective circuit breaker.

- 1 Check that all wires are properly connected and that all connectors are fully plugged-in.
- 2 Check that no connectors or wires are damaged.
- 3 Check that the wiring corresponds with the wiring diagram, see "[7.2 Wiring diagram](#)" [▶ 235].



INFORMATION

Correct the wiring as needed.

Is the problem solved?	Action
Yes	No further actions required.
No	Return to " 4.9.1 Checking procedures " [▶ 110] of the indoor unit power PCB and continue with the next procedure.

To check the fuse of the indoor unit main PCB

Prerequisite: First perform all earlier checks of the indoor unit main PCB, see "[4.10.1 Checking procedures](#)" [▶ 116].

- 1 Measure the continuity of the fuse. If no continuity is measured, the fuse has blown.

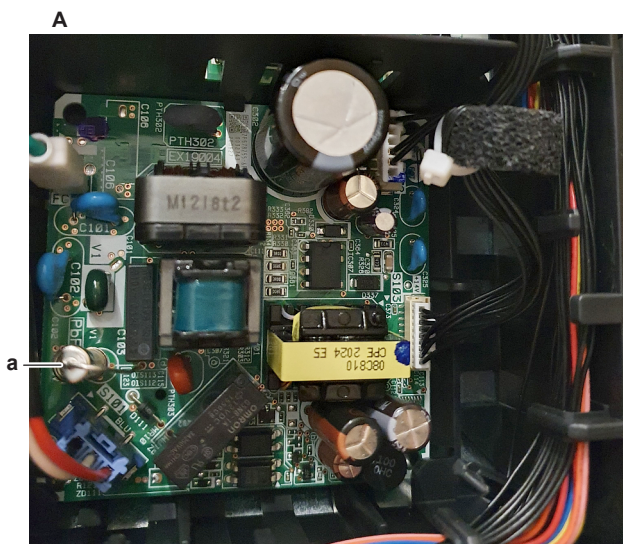

A Wall mounted indoor unit
a Fuse F1U

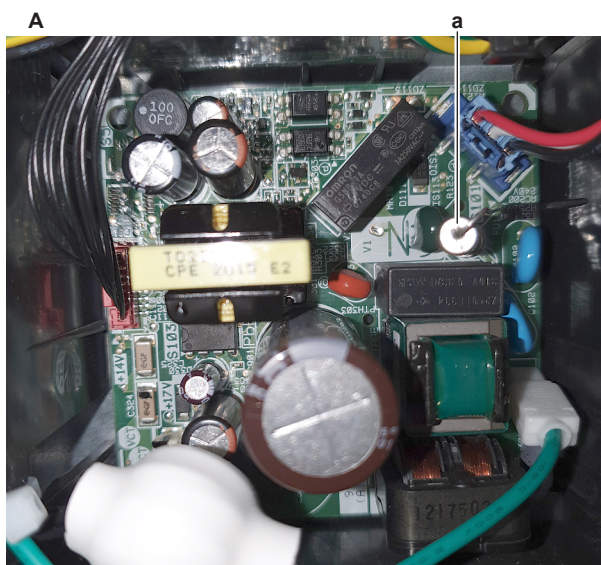

A Floor standing indoor unit
a Fuse F1U

Blown fuse on the indoor unit power PCB?	Action
Yes	Replace the blown fuse, see "4.10.2 Repair procedures" [▶ 121].
No	Return to "4.9.1 Checking procedures" [▶ 110] of the indoor unit power PCB and continue with the next procedure.

Problem solved?

After all checking procedures listed above have been performed:

Is the problem solved?	Action
Yes	No further actions required.
No	Return to the troubleshooting of the specific error and continue with the next procedure.

4.10.2 Repair procedures

To correct the wiring from the indoor unit power supply terminal to the indoor unit power PCB

Prerequisite: Stop the unit operation via the user interface.

Prerequisite: Turn OFF the respective circuit breaker.

Prerequisite: Remove the required plate work, see ["4.14 Plate work"](#) [▶ 157].

- 1 Correct the wiring from the indoor unit power supply terminal to the indoor unit power PCB, see ["7.2 Wiring diagram"](#) [▶ 235].

Is the problem solved?	Action
Yes	No further actions required.
No	Return to "4.9.1 Checking procedures" [▶ 110] of the indoor unit power PCB and continue with the next procedure.

To remove the indoor unit power PCB

Prerequisite: Stop the unit operation via the user interface.

Prerequisite: Turn OFF the respective circuit breaker.

Prerequisite: Remove the required plate work, see ["4.14 Plate work"](#) [▶ 157].

- 1 Disconnect all connectors from the indoor unit power PCB.
- 2 Carefully click the indoor unit power PCB out of the PCB retainers.

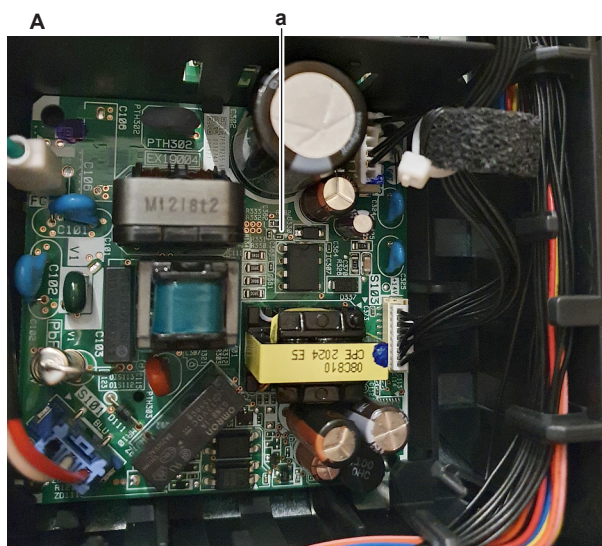

A Wall mounted indoor unit
a Indoor unit power PCB

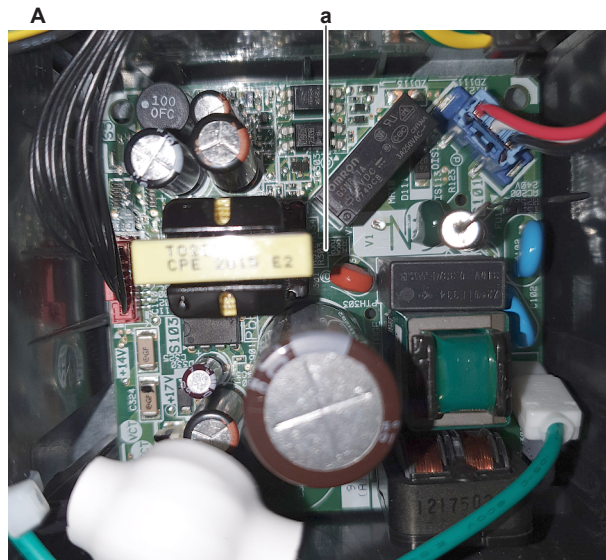

A Floor standing indoor unit
a Indoor unit power PCB

- 3 Remove the indoor unit power PCB from the indoor unit.
- 4 To install the indoor unit power PCB, see "[4.10.2 Repair procedures](#)" [▶ 121].

To install the indoor unit power PCB

- 1 Install the indoor unit power PCB in the correct location in the switch box. Make sure the PCB is correctly fixed by the PCB retainers.

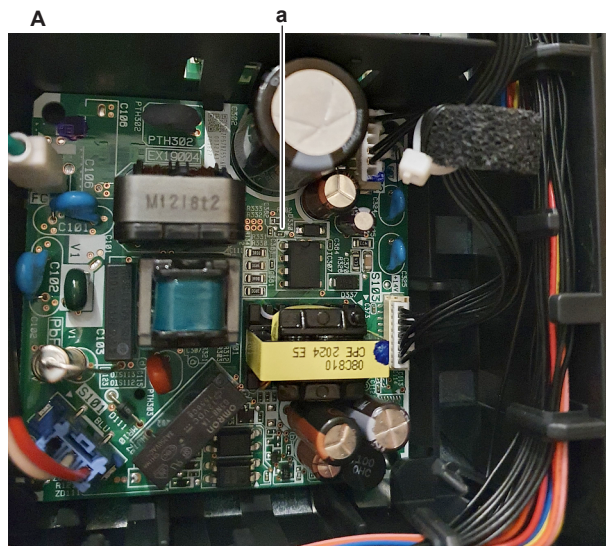

A Wall mounted indoor unit
a Indoor unit power PCB

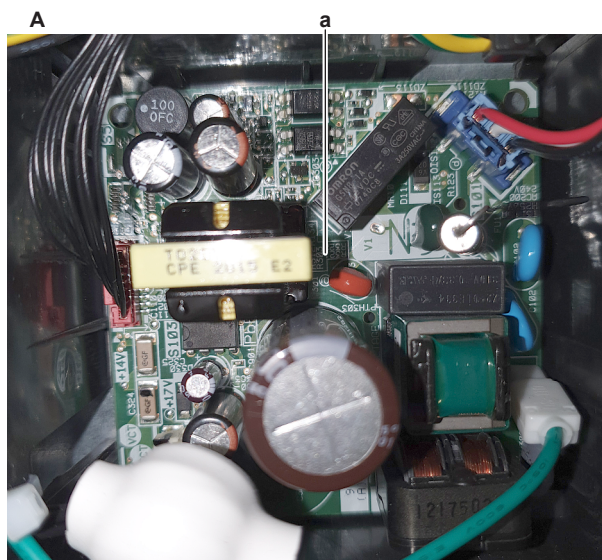

A Floor standing indoor unit
a Indoor unit power PCB

- 2 Connect all connectors to the indoor unit power PCB.



INFORMATION

Use the wiring diagram and connection diagram for correct installation of the connectors, see "[7.2 Wiring diagram](#)" [▶ 235].



WARNING

When reconnecting a connector to the PCB, make sure to connect it on the correct location and do NOT apply force, as this may damage the connector or connector pins of the PCB.

Is the problem solved?	Action
Yes	No further actions required.
No	Return to " 4.9.1 Checking procedures " [▶ 110] of the indoor unit power PCB and continue with the next procedure.

To remove a fuse of the indoor unit power PCB

Prerequisite: Stop the unit operation via the user interface.

Prerequisite: Turn OFF the respective circuit breaker.

Prerequisite: Remove the required plate work, see "[4.14 Plate work](#)" [▶ 157].

- 1 Remove the fuse from the PCB.



A Wall mounted indoor unit
a Fuse F1U

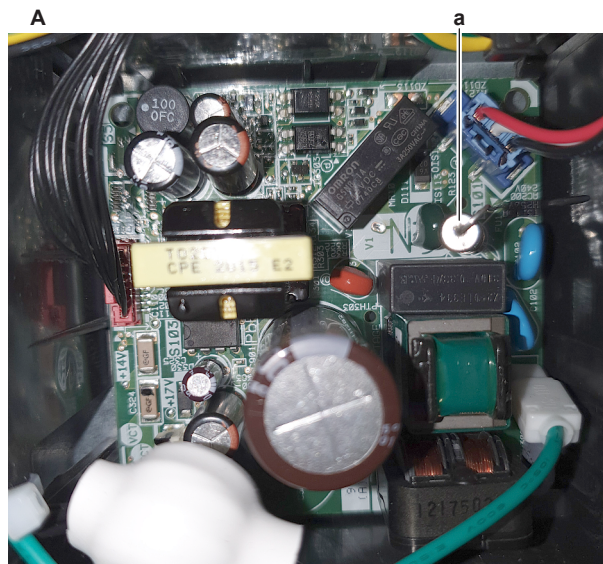

A Floor standing indoor unit
a Fuse F1U

- 2 To install a fuse on the indoor unit power PCB, see "[4.10.2 Repair procedures](#)" [▶ 121].

To install a fuse on the indoor unit power PCB

- 1 Install the fuse on the correct location on the PCB.



CAUTION
Make sure the fuse is plugged-in correctly (contact with the fuse holder).

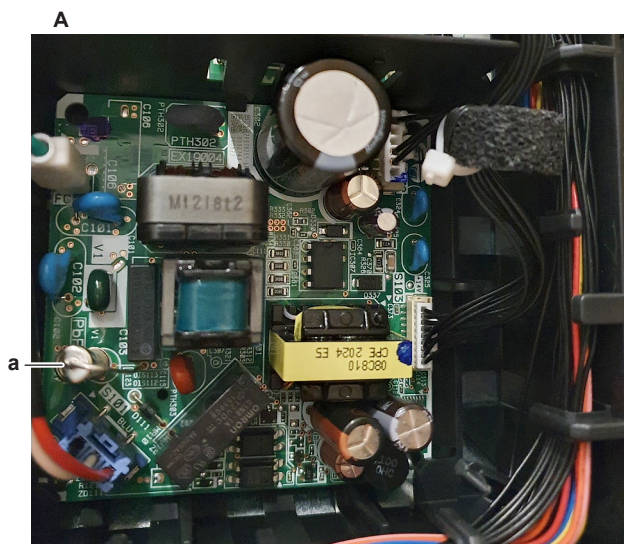

A Wall mounted indoor unit
a Fuse F1U

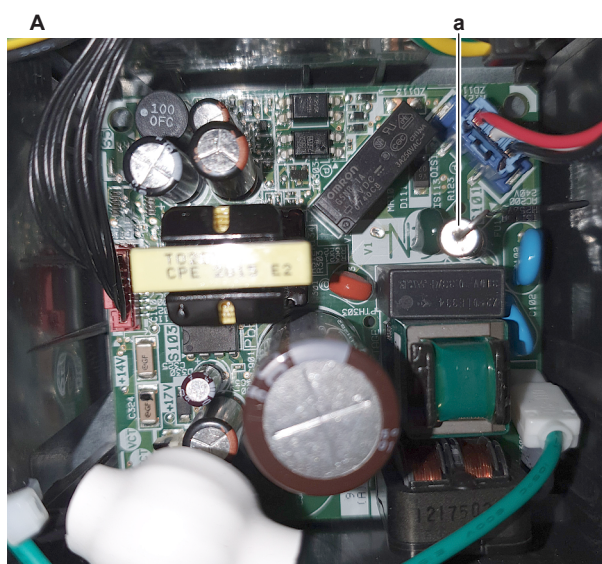

A Floor standing indoor unit
a Fuse F1U

Is the problem solved?	Action
Yes	No further actions required.
No	Return to "4.9.1 Checking procedures" [▶ 110] of the indoor unit power PCB and continue with the next procedure.

4.11 Intelligent eye sensor

4.11.1 Checking procedures



INFORMATION

It is recommended to perform the checks in the listed order.

To perform a power check of the intelligent eye sensor

Prerequisite: Stop the unit operation via the user interface.

Prerequisite: Turn OFF the respective circuit breaker.

- 1 Remove the required plate work, see "4.14 Plate work" [▶ 157].
- 2 Turn ON the power of the unit.
- 3 Remove the control panel from the indoor unit.
- 4 Measure the power supply voltage between the pins 1-2 on the intelligent eye sensor connector CN.

Result: The measured voltage MUST be 4.75~5.25 V DC.

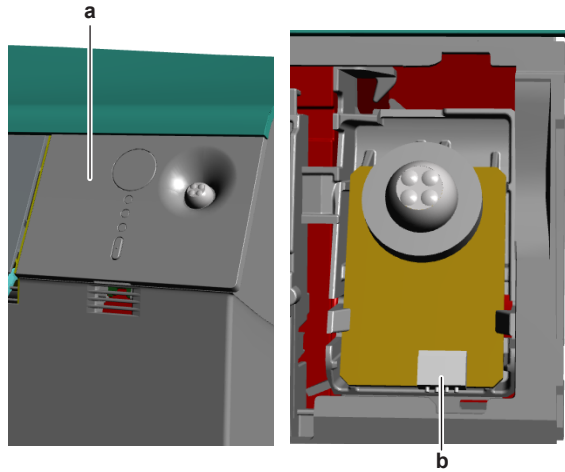

a Control panel
b Intelligent eye sensor connector CN

Is the measured power supply voltage correct?	Action
Yes	Perform an electrical check of the intelligent eye sensor, see "4.11.1 Checking procedures" [▶ 125].
No	Continue with the next step.

- 5 Measure the output voltage between between the pins 1-2 on the connector S602 on the indoor unit main PCB.

Result: The measured voltage MUST be 4.75~5.25 V DC.

Is the output voltage on the indoor unit main PCB correct?	Action
Yes	Replace the intelligent eye sensor wiring harness, see "4.11.2 Repair procedures" [▶ 128].
No	Perform a check of the indoor unit main PCB, see "4.9.1 Checking procedures" [▶ 110].

To perform an electrical check of the intelligent eye sensor

Prerequisite: First perform a power check of the intelligent eye sensor, see "4.11.1 Checking procedures" [▶ 125].

- 1 Leave the intelligent eye sensor connector S602 connected to the indoor unit main PCB.

- 2** Wave your hand in front of the left side (when facing the indoor unit) of the intelligent eye sensor and measure the voltage between the following pins of the intelligent eye sensor connector S602.

Result: The measured voltage MUST be:

Connector pins	Voltage
2-3	4.25~4.75 V DC
2-4	0 V DC

- 3** Wave your hand in front of the right side (when facing the indoor unit) of the intelligent eye sensor and measure the voltage between the following pins of the intelligent eye sensor connector S602.

Result: The measured voltage MUST be:

Connector pins	Voltage
2-3	0 V DC
2-4	4.25~4.75 V DC

Is the measured voltage correct?	Action
Yes	Intelligent eye sensor is OK. Return to troubleshooting of the specific error and continue with the next procedure.
No	Continue with the next step.

- 4** Again, wave your hand in front of the left side (when facing the indoor unit) of the intelligent eye sensor and measure the voltage between the following pins of the intelligent eye sensor connector CN.

Result: The measured voltage MUST be:

Connector pins	Voltage
2-3	0 V DC
2-4	4.25~4.75 V DC

- 5** Again, wave your hand in front of the right side (when facing the indoor unit) of the intelligent eye sensor and measure the voltage between the following pins of the intelligent eye sensor connector CN.

Result: The measured voltage MUST be:

Connector pins	Voltage
2-3	4.25~4.75 V DC
2-4	0 V DC

Is the measured voltage on the intelligent eye sensor correct?	Action
Yes	Replace the intelligent eye sensor wiring harness, see " 4.11.2 Repair procedures " [▶ 128].
No	Replace the intelligent eye sensor, see " 4.11.2 Repair procedures " [▶ 128].

4.11.2 Repair procedures

To remove the intelligent eye sensor

Prerequisite: Stop the unit operation via the user interface.

Prerequisite: Turn OFF the respective circuit breaker.

Prerequisite: Remove the required plate work, see "4.14 Plate work" [▶ 157].

- 1 Remove the control panel from the indoor unit.

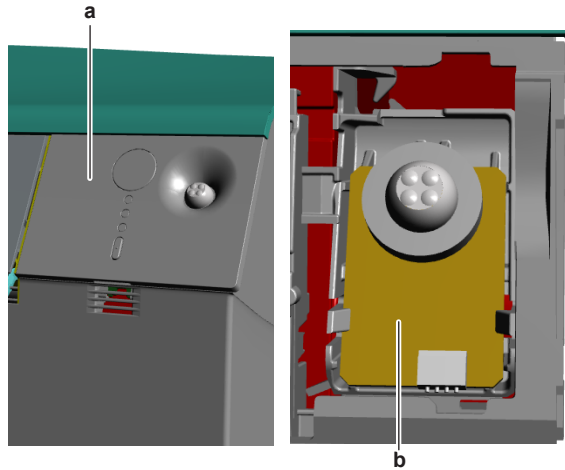

a Control panel
b Intelligent eye sensor PCB

- 2 Disconnect the connector from the intelligent eye sensor PCB.
- 3 Carefully click the complete intelligent eye sensor PCB out of the indoor unit.
- 4 To install the intelligent eye sensor PCB, see "4.11.2 Repair procedures" [▶ 128].

To install the intelligent eye sensor

- 1 Click the intelligent eye sensor PCB on the indoor unit.

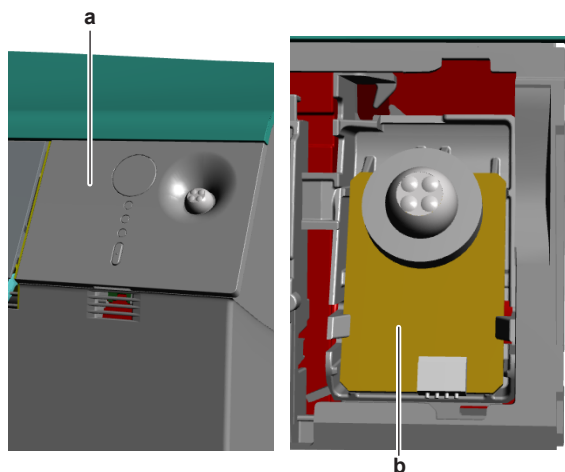

a Control panel
b Intelligent eye sensor PCB

- 2 Connect the harness to the intelligent eye sensor PCB.
- 3 Install the control panel on the indoor unit.

Is the problem solved?	Action
Yes	No further actions required.

Is the problem solved?	Action
No	Return to the troubleshooting of the specific error and continue with the next procedure.

To remove the intelligent eye sensor wiring harness

Prerequisite: Stop the unit operation via the user interface.

Prerequisite: Turn OFF the respective circuit breaker.

Prerequisite: Remove the required plate work, see "[4.14 Plate work](#)" [▶ 157].

- 1 Disconnect the wiring harness from the intelligent eye sensor (PCB).
- 2 Disconnect the wiring harness connector from the indoor unit main PCB.
- 3 Cut all tie straps (if any) that fix the wiring harness.
- 4 Route the wiring harness out of the harness retainers and remove the intelligent eye sensor wiring harness.
- 5 To install the intelligent eye sensor wiring harness, see "[4.11.2 Repair procedures](#)" [▶ 128].

To install the intelligent eye sensor wiring harness

- 1 Connect the wiring harness connector to the indoor unit main PCB.



WARNING

When reconnecting a connector to the PCB, make sure to connect it on the correct location and do NOT apply force, as this may damage the connector or connector pins of the PCB.

- 2 Route the wiring harness through the appropriate harness retainers towards the intelligent eye sensor (PCB).
- 3 Connect the wiring harness to the intelligent eye sensor (PCB).
- 4 Fix the wiring harness using new tie straps (if needed).

Is the problem solved?	Action
Yes	No further actions required.
No	Return to the troubleshooting of the specific error and continue with the next procedure.

4.12 Main PCB

4.12.1 Class 20~35 units

Checking procedures



INFORMATION

It is recommended to perform the checks in the listed order.

To perform a power check of the main PCB

Prerequisite: Stop the unit operation via the user interface.

Prerequisite: Turn OFF the respective circuit breaker.

Prerequisite: Remove the required plate work, see "4.14 Plate work" [▶ 157].

- 1 Turn ON the power of the unit.
- 2 Measure the voltage between the black and white wires.

Result: The measured voltage MUST be 230 V AC.

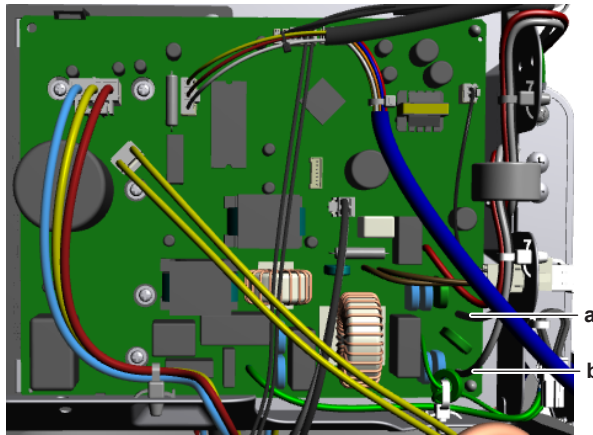

a Black wire
b White wire

Is the measured voltage on the PCB correct?	Action
Yes	Return to "Checking procedures" [▶ 129] of the PCB and continue with the next procedure.
No	Continue with the next step.

- 3 Check the power supply to the unit, see "5.1.1 Checking procedures" [▶ 212].

Does the unit receive power?	Action
Yes	Replace the main PCB, see "Repair procedures" [▶ 137].
No	Adjust the power supply to the unit, see "5.1.2 Repair procedures" [▶ 213].

To check the HAP LED of the main PCB

Prerequisite: First check the power supply to the main PCB, see "Checking procedures" [▶ 129].

- 1 Locate the HAP LED on the main PCB.

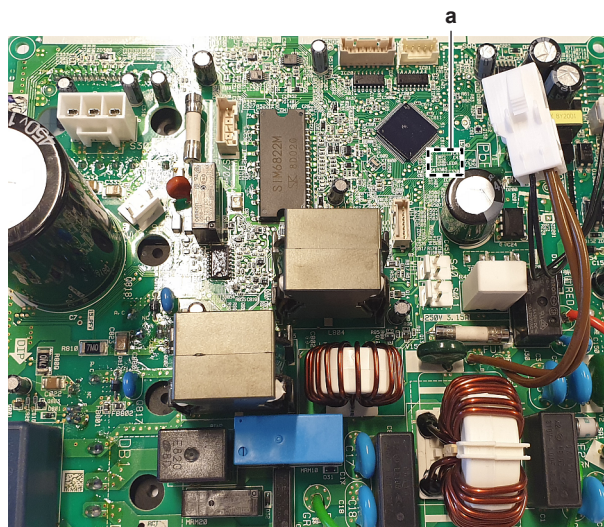

a HAP LED

**INFORMATION**

Make sure the correct software is available on the PCB. If NOT, update using the updater tool.

Does the HAP LED blink in regular intervals (1 second ON/1 second OFF)?	Action
Yes	Return to " Checking procedures " [▶ 129] of the main PCB and continue with the next procedure.
No	Replace the main PCB, see " Repair procedures " [▶ 137].

To check if the correct spare part is installed

Prerequisite: First perform all earlier main PCB checks, see "[Checking procedures](#)" [▶ 129].

- 1 Visit your local spare parts webbank.
- 2 Enter the model name of your unit and check if the installed spare part number corresponds with the spare part number indicated in the webbank.

**NOTICE**

Also check that the correct spare part is installed for the capacity adapter.

Is the correct spare part for the PCB installed?	Action
Yes	Return to " Checking procedures " [▶ 129] of the main PCB and continue with the next procedure.
No	Replace the main PCB, see " Repair procedures " [▶ 137].

To check the wiring of the main PCB

Prerequisite: First perform all earlier main PCB checks, see "[Checking procedures](#)" [▶ 129].

Prerequisite: Stop the unit operation via the user interface.

- 1 Turn OFF the respective circuit breaker.
- 2 Check that all wires are properly connected and that all connectors are fully plugged-in.
- 3 Check that no connectors or wires are damaged.
- 4 Check that the wiring corresponds with the wiring diagram, see "[7.2 Wiring diagram](#)" [▶ 235].

**INFORMATION**

Correct the wiring as needed.

Is the problem solved?	Action
Yes	No further actions required.

Is the problem solved?	Action
No	Return to "Checking procedures" [▶ 129] of the PCB and continue with the next procedure.

To check the fuse of the main PCB

Prerequisite: First perform all earlier main PCB checks, see "Checking procedures" [▶ 129].

- 1 Measure the continuity of the fuse. If no continuity is measured, the fuse has blown.

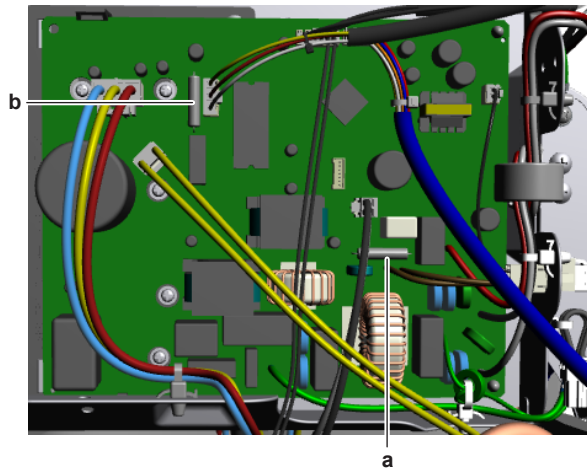

a Fuse F1U
b Fuse F2U

Blown fuse on the main PCB?	Action
Yes	Replace the main PCB, see "Repair procedures" [▶ 137].
No	Return to "Checking procedures" [▶ 129] of the main PCB and continue with the next procedure.

To check the rectifier voltage of the main PCB

Prerequisite: First perform all earlier main PCB checks, see "Checking procedures" [▶ 129].

- 1 Turn ON the power of the unit.
- 2 Measure the voltage on the rectifier voltage check terminals (+ and –) on the main PCB.

Result: The measured voltage MUST be approximately 324 V DC.

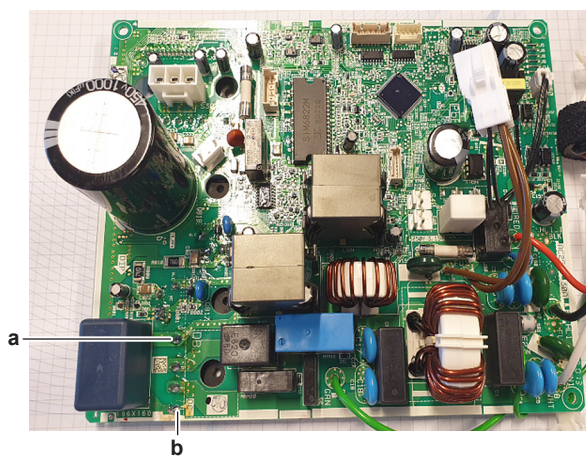

a + terminal
b - terminal



INFORMATION

When measuring on the front of the main PCB, make sure to locally remove the protective varnish with the test leads of the multi meter.

Is the measured rectifier voltage correct?	Action
Yes	Perform a check of the power modules, see " Checking procedures " [▶ 129].
No	Replace the main PCB, see " Repair procedures " [▶ 137].

To perform a diode module check

- 1 First check the rectifier voltage of the main PCB, see "[Checking procedures](#)" [▶ 129].



INFORMATION

If the rectifier voltage is OK, the diode module is OK. If rectifier voltage is NOT OK, replace the main PCB.

Below procedure describes how to check the diode module itself.

Prerequisite: Stop the unit operation via the user interface.

- 2 Turn OFF the respective circuit breaker.



DANGER: RISK OF ELECTROCUTION

Wait for at least 10 minutes after the circuit breaker has been turned OFF, to be sure the rectifier voltage is below 10 V DC before proceeding.

- 3 Check the diode module in reference with the image and the table below.

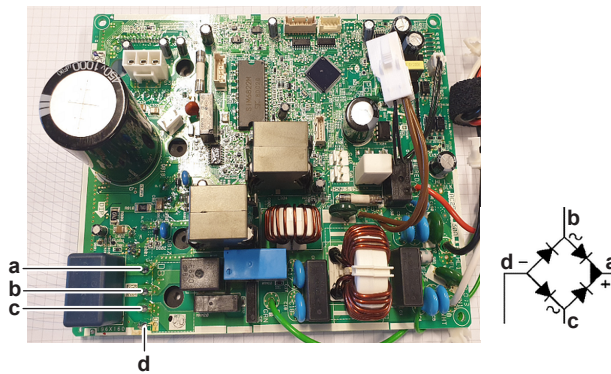

- a V DC out (+)
- b V AC in
- c V AC in
- d V DC out (-)



INFORMATION

When measuring on the front of the main PCB, make sure to locally remove the protective varnish with the test leads of the multi meter.

VDC	Com	Ref	VDC	Com	Ref
d	b	0.51~0.52 V	b	d	O.L
b	a	0.51~0.52 V	a	b	O.L
d	c	0.51~0.52 V	c	d	O.L
c	a	0.51~0.52 V	a	c	O.L

- 4 If the diode module is NOT OK, replace the main PCB, see "[Repair procedures](#)" [▶ 137].

To perform a power module check

Prerequisite: First check the rectifier voltage of the main PCB, see "[Checking procedures](#)" [▶ 129].

Prerequisite: Stop the unit operation via the user interface.

- 1 Turn OFF the respective circuit breaker.



DANGER: RISK OF ELECTROCUTION

Wait for at least 10 minutes after the circuit breaker has been turned OFF, to be sure the rectifier voltage is below 10 V DC before proceeding.

Power module IPM1 for compressor

- 1 Disconnect the compressor connector from the main PCB.
- 2 Check the power module IPM1 in reference with the image and the table below.

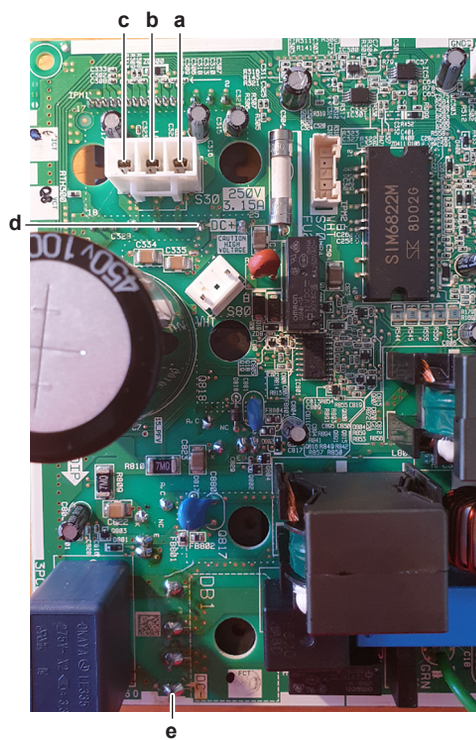

- a U
- b V
- c W
- d DC+
- e DC-



INFORMATION

When measuring on the front of the main PCB, make sure to locally remove the protective varnish with the test leads of the multi meter.

VDC	Com	Ref	VDC	Com	Ref
U	DC+	0.501 V	DC+	U	O.L
V	DC+	0.501 V	DC+	V	O.L
W	DC+	0.501 V	DC+	W	O.L
DC-	U	0.501 V	U	DC-	O.L
DC-	V	0.501 V	V	DC-	O.L
DC-	W	0.501 V	W	DC-	O.L

Power module IPM2 for fan motor

- 1 Disconnect the fan motor connector from the main PCB.
- 2 Check the power module IPM2 in reference with the image and the table below.

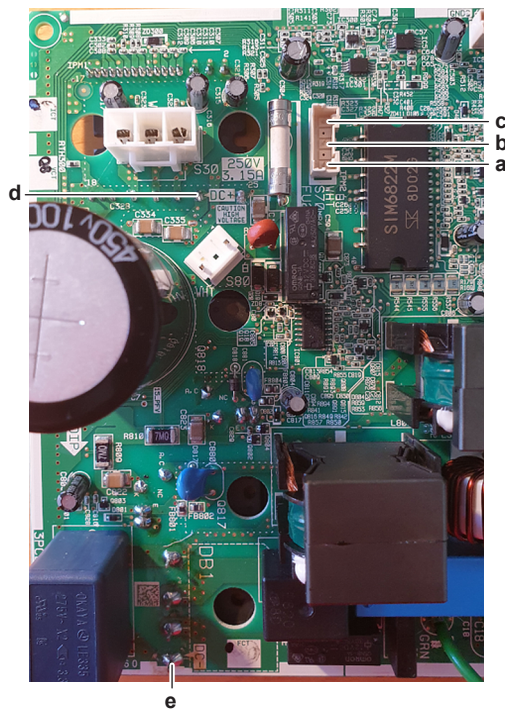

- a U
- b V
- c W
- d DC+
- e DC-



INFORMATION

When measuring on the front of the main PCB, make sure to locally remove the protective varnish with the test leads of the multi meter.

VDC	Com	Ref	VDC	Com	Ref
U	DC+	0.475 V	DC+	U	O.L
V	DC+	0.475 V	DC+	V	O.L
W	DC+	0.475 V	DC+	W	O.L
DC-	U	0.475 V	U	DC-	O.L
DC-	V	0.475 V	V	DC-	O.L
DC-	W	0.475 V	W	DC-	O.L

Are the test results OK?	Action
Yes	Power modules are OK. Return to "Checking procedures" [▶ 129] of the main PCB and continue with the next procedure.
No	Replace the main PCB, see "Repair procedures" [▶ 137].

Problem solved?

After all checking procedures listed above have been performed:

Is the problem solved?	Action
Yes	No further actions required.

Is the problem solved?	Action
No	Return to the troubleshooting of the specific error and continue with the next procedure.

Repair procedures

To remove the main PCB

Prerequisite: Stop the unit operation via the user interface.

Prerequisite: Turn OFF the respective circuit breaker.

Prerequisite: Remove the required plate work, see "[4.14 Plate work](#)" [[▶ 157](#)].

- 1 Disconnect the power supply wires from the main power supply terminal X1M.
- 2 Remove the ferrite core(s) (for power supply wiring) from the switch box (unplug fixation plug).

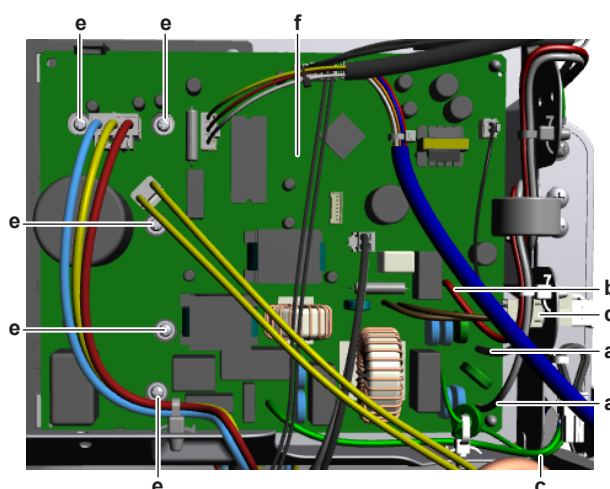

- a Power supply wires from X1M
- b Wire from X1M
- c Ground wiring
- d Connector X11A
- e Screw
- f Main PCB

- 3 Disconnect the wire from the terminal X1M.
- 4 Remove the screw and remove the ground wiring from the switch box.
- 5 Remove the ferrite core (for ground wiring) from the switch box (unplug fixation plug).
- 6 Disconnect the connector X11A.
- 7 Disconnect all other connectors from the main PCB.
- 8 Remove the screws from the main PCB.
- 9 Remove the main PCB from the unit.
- 10 To install the main PCB, see "[Repair procedures](#)" [[▶ 137](#)].

To install the main PCB

- 1 Apply grease to the PCB contact surface of the heat sink. Distribute the grease as evenly as possible.



CAUTION

ALWAYS apply new grease on the PCB heat sink. NOT doing so may cause the PCB to fail due to insufficient cooling.

2 Install the main PCB in the correct location in the switch box.

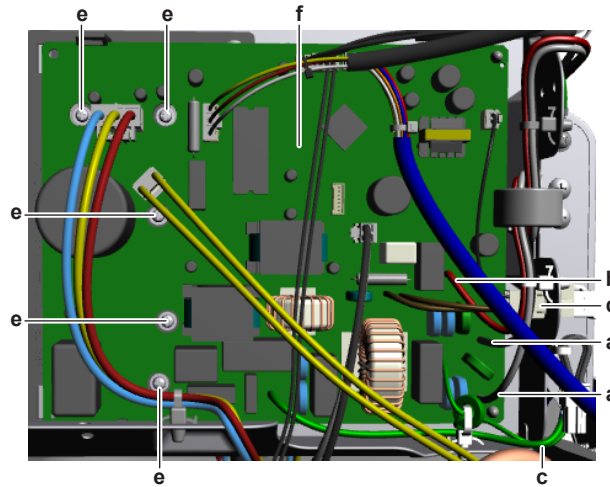

- a Power supply wires from X1M
- b Wire from X1M
- c Ground wiring
- d Connector X11A
- e Screw
- f Main PCB

- 3 Install and tighten the screws.
- 4 Install the ground wiring on the switch box and fix using the screw.
- 5 Fix the ferrite core (for ground wiring) to the switch box (fixation plug).
- 6 Connect the connector X11A.
- 7 Connect the power supply wiring to the main power supply terminal X1M.
- 8 Connect the wire to the main power supply terminal X1M.
- 9 Fix the ferrite core(s) (for power supply wiring) to the switch box (fixation plug).
- 10 Connect all other connectors to the main PCB.



INFORMATION

Use the wiring diagram and connection diagram for correct installation of the connectors, see "[7.2 Wiring diagram](#)" [▶ 235].

Is the problem solved?	Action
Yes	No further actions required.
No	Return to " Checking procedures " [▶ 129] of the PCB and continue with the next procedure.

4.12.2 Class 42~71 units

Checking procedures

**INFORMATION**

It is recommended to perform the checks in the listed order.

To perform a power check of the main PCB

Prerequisite: Stop the unit operation via the user interface.

Prerequisite: Turn OFF the respective circuit breaker.

Prerequisite: Remove the required plate work, see ["4.14 Plate work"](#) [▶ 157].

- 1 Turn ON the power of the unit.
- 2 Measure the voltage between the black and white wires.

Result: The measured voltage MUST be 230 V AC.

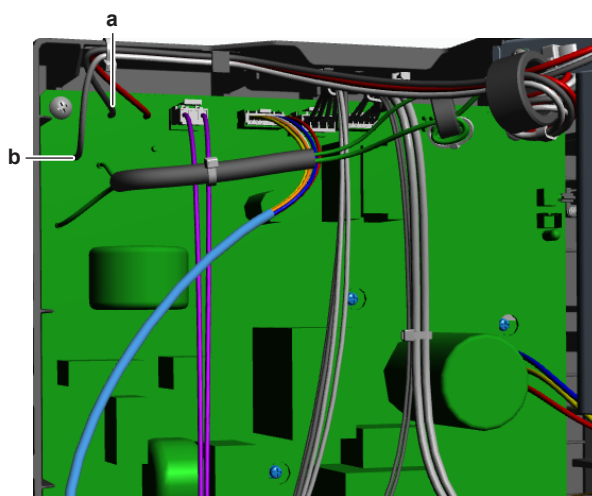

- a Black wire
b White wire

Is the measured voltage on the PCB correct?	Action
Yes	Return to "Checking procedures" [▶ 139] of the PCB and continue with the next procedure.
No	Continue with the next step.

- 3 Check the power supply to the unit, see ["5.1.1 Checking procedures"](#) [▶ 212].

Does the unit receive power?	Action
Yes	Replace the main PCB, see "Repair procedures" [▶ 144].
No	Adjust the power supply to the unit, see "5.1.2 Repair procedures" [▶ 213].

To check the HAP LED of the main PCB

Prerequisite: First check the power supply to the main PCB, see ["Checking procedures"](#) [▶ 139].

- 1 Locate the HAP LED on the main PCB.



a HAP LED



INFORMATION

Make sure the correct software is available on the PCB. If NOT, update using the updater tool.

Does the HAP LED blink in regular intervals (1 second ON/1 second OFF)?	Action
Yes	Return to " Checking procedures " [▶ 139] of the main PCB and continue with the next procedure.
No	Replace the main PCB, see " Repair procedures " [▶ 144].

To check if the correct spare part is installed

Prerequisite: First perform all earlier main PCB checks, see "[Checking procedures](#)" [▶ 139].

- 1 Visit your local spare parts webbank.
- 2 Enter the model name of your unit and check if the installed spare part number corresponds with the spare part number indicated in the webbank.



NOTICE

Also check that the correct spare part is installed for the capacity adapter.

Is the correct spare part for the PCB installed?	Action
Yes	Return to " Checking procedures " [▶ 139] of the main PCB and continue with the next procedure.
No	Replace the main PCB, see " Repair procedures " [▶ 144].

To check the wiring of the main PCB

Prerequisite: First perform all earlier main PCB checks, see "[Checking procedures](#)" [▶ 139].

Prerequisite: Stop the unit operation via the user interface.

- 1 Turn OFF the respective circuit breaker.

- 2 Check that all wires are properly connected and that all connectors are fully plugged-in.
- 3 Check that no connectors or wires are damaged.
- 4 Check that the wiring corresponds with the wiring diagram, see ["7.2 Wiring diagram" \[▶ 235\]](#).

**INFORMATION**

Correct the wiring as needed.

Is the problem solved?	Action
Yes	No further actions required.
No	Return to "Checking procedures" [▶ 139] of the PCB and continue with the next procedure.

To check the fuse of the main PCB

Prerequisite: First perform all earlier main PCB checks, see ["Checking procedures" \[▶ 139\]](#).

- 1 Measure the continuity of the fuse. If no continuity is measured, the fuse has blown.

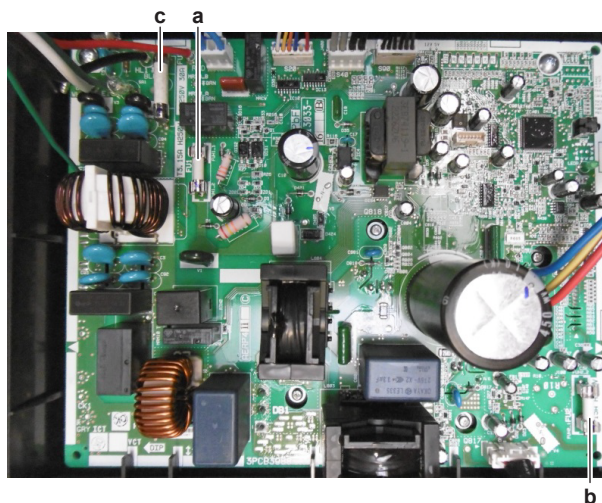

- a Fuse F1U
- b Fuse F2U
- c Fuse F3U

Blown fuse on the main PCB?	Action
Yes	Replace the main PCB, see "Repair procedures" [▶ 144] .
No	Return to "Checking procedures" [▶ 139] of the main PCB and continue with the next procedure.

To check the rectifier voltage of the main PCB

Prerequisite: First perform all earlier main PCB checks, see ["Checking procedures" \[▶ 139\]](#).

- 1 Turn ON the power of the unit.

- 2 Measure the voltage on the rectifier voltage check terminals (+ and –) on the main PCB.

Result: The measured voltage MUST be approximately 300~350 V DC.

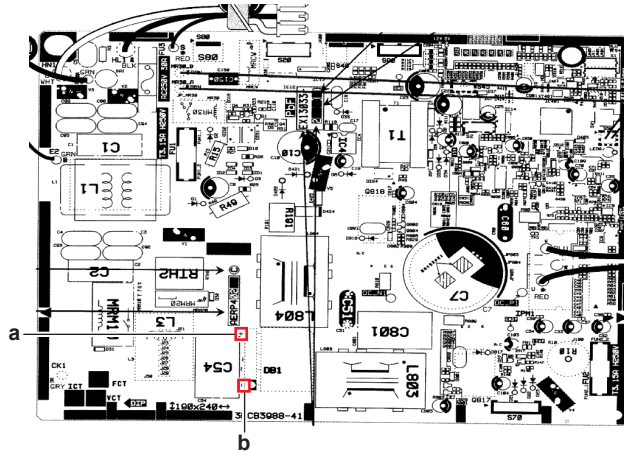

- a + terminal
- b - terminal



INFORMATION

When measuring on the front of the main PCB, make sure to locally remove the protective varnish with the test leads of the multi meter.

Is the measured rectifier voltage correct?	Action
Yes	Perform a check of the power module, see "Checking procedures" [▶ 139].
No	Replace the main PCB, see "Repair procedures" [▶ 144].

To perform a diode module check

- 1 First check the rectifier voltage of the main PCB, see "Checking procedures" [▶ 139].



INFORMATION

If the rectifier voltage is OK, the diode module is OK. If rectifier voltage is NOT OK, replace the main PCB.

Below procedure describes how to check the diode module itself.

Prerequisite: Stop the unit operation via the user interface.

- 2 Turn OFF the respective circuit breaker.



DANGER: RISK OF ELECTROCUTION

Wait for at least 10 minutes after the circuit breaker has been turned OFF, to be sure the rectifier voltage is below 10 V DC before proceeding.

- 3 Check the diode module in reference with the image and the table below.

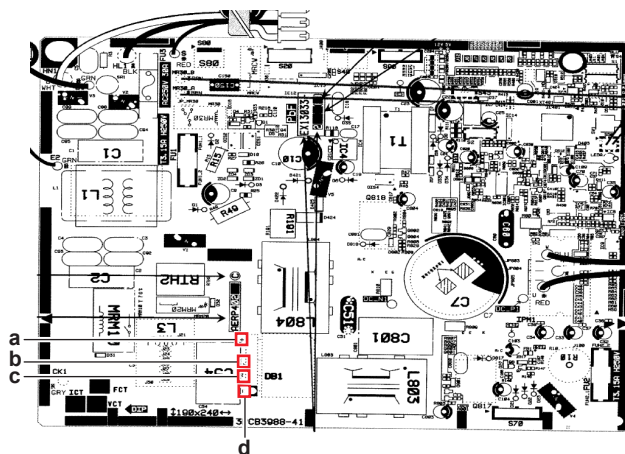

- a V DC out (+)
- b V AC in
- c V AC in
- d V DC out (-)



INFORMATION

When measuring on the front of the main PCB, make sure to locally remove the protective varnish with the test leads of the multi meter.

VDC	Com	Ref	VDC	Com	Ref
d	b	0.51~0.52 V	b	d	O.L
b	a	0.51~0.52 V	a	b	O.L
d	c	0.51~0.52 V	c	d	O.L
c	a	0.51~0.52 V	a	c	O.L

- 4 If the diode module is NOT OK, replace the main PCB, see "[Repair procedures](#)" [▶ 144].

To perform a power module check

Prerequisite: First check the rectifier voltage of the main PCB, see "[Checking procedures](#)" [▶ 139].

Prerequisite: Stop the unit operation via the user interface.

- 1 Turn OFF the respective circuit breaker.



DANGER: RISK OF ELECTROCUTION

Wait for at least 10 minutes after the circuit breaker has been turned OFF, to be sure the rectifier voltage is below 10 V DC before proceeding.

Power module IPM1 for compressor

- 1 Disconnect the compressor connector.
- 2 Check the power module IPM1 in reference with the image and the table below.

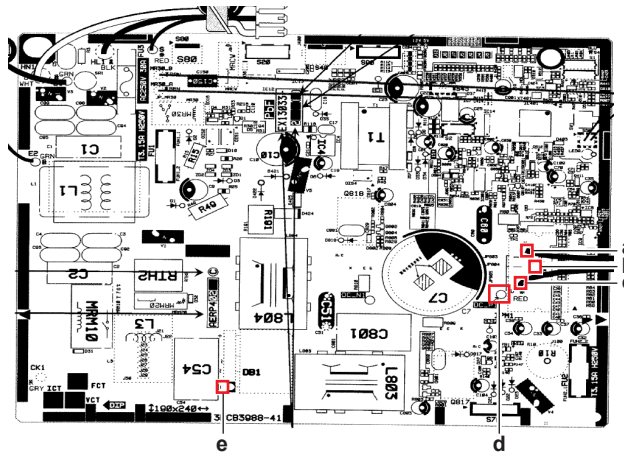

- a U
- b V
- c W
- d DC+
- e DC-



INFORMATION

When measuring on the front of the main PCB, make sure to locally remove the protective varnish with the test leads of the multi meter.

VDC	Com	Ref	VDC	Com	Ref
U	DC+	0.501 V	DC+	U	O.L
V	DC+	0.501 V	DC+	V	O.L
W	DC+	0.501 V	DC+	W	O.L
DC-	U	0.501 V	U	DC-	O.L
DC-	V	0.501 V	V	DC-	O.L
DC-	W	0.501 V	W	DC-	O.L

Are the test results OK?	Action
Yes	Power module is OK. Return to "Checking procedures" [▶ 139] of the main PCB and continue with the next procedure.
No	Replace the main PCB, see "Repair procedures" [▶ 144].

Problem solved?

After all checking procedures listed above have been performed:

Is the problem solved?	Action
Yes	No further actions required.
No	Return to the troubleshooting of the specific error and continue with the next procedure.

Repair procedures

To remove the main PCB

Prerequisite: Stop the unit operation via the user interface.

Prerequisite: Turn OFF the respective circuit breaker.

Prerequisite: Remove the required plate work, see ["4.14 Plate work"](#) [▶ 157].

- 1 Disconnect the power supply wires from the main power supply terminal X1M.
- 2 Remove the ferrite core (for power supply wires) from the switch box (unplug fixation plug).
- 3 Cut the tie strap that fixes the power supply wires to the switch box.

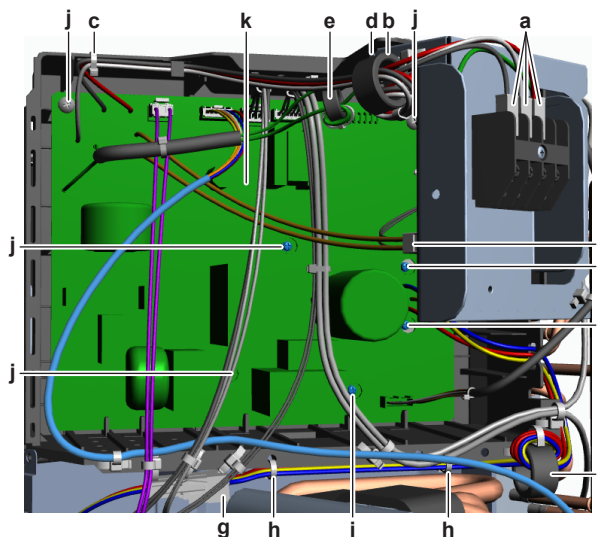

- a Power supply wires from X1M
- b Ferrite core (power supply wires)
- c Tie strap (power supply wires)
- d Screw (ground wiring)
- e Ferrite core (ground wiring)
- f Connector X12A
- g Compressor connector
- h Tie strap (compressor harness)
- i Ferrite core (compressor harness)
- j Screw
- k Main PCB

- 4 Remove the screw and remove the ground wiring from the switch box.
- 5 If applicable: Disconnect the connector X12A.
- 6 Disconnect the compressor connector.
- 7 Cut the tie straps that fix the compressor harness to the switch box.
- 8 Remove the ferrite core (for compressor harness) from the switch box (unplug fixation plug).
- 9 Disconnect all other connectors from the main PCB.
- 10 Remove the screws from the main PCB.
- 11 Remove the main PCB from the unit.
- 12 To install the main PCB, see ["Repair procedures"](#) [▶ 144].

To install the main PCB

- 1 Apply grease to the PCB contact surface of the heat sink. Distribute the grease as evenly as possible.



CAUTION

ALWAYS apply new grease on the PCB heat sink. NOT doing so may cause the PCB to fail due to insufficient cooling.

2 Install the main PCB in the correct location in the switch box.

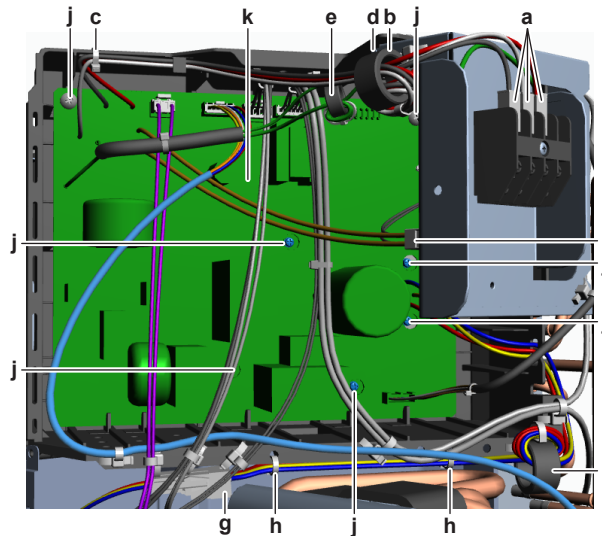

- a Power supply wires from X1M
- b Ferrite core (power supply wires)
- c Tie strap (power supply wires)
- d Screw (ground wiring)
- e Ferrite core (ground wiring)
- f Connector X12A
- g Compressor connector
- h Tie strap (compressor harness)
- i Ferrite core (compressor harness)
- j Screw
- k Main PCB

3 Install and tighten the screws.

4 Fix the ferrite core (for compressor harness) to the switch box (fixation plug).

5 Install new tie straps to fix the compressor harness to the switch box.

6 Install the ground wiring on the switch box and fix using the screw.

7 If applicable: Connect the connector X12A.

8 Fix the ferrite core (for power supply wiring) to the switch box (fixation plug).

9 Connect the power supply wiring to the main power supply terminal X1M.

10 Fix the power supply wiring to the switch box using a new tie strap.

11 Connect all other connectors to the main PCB.



INFORMATION

Use the wiring diagram and connection diagram for correct installation of the connectors, see "7.2 Wiring diagram" [▶ 235].

Is the problem solved?	Action
Yes	No further actions required.
No	Return to "Checking procedures" [▶ 139] of the PCB and continue with the next procedure.

4.13 Outdoor unit fan motor

4.13.1 Class 20~35 units

Checking procedures



INFORMATION

It is recommended to perform the checks in the listed order.

To perform a mechanical check of the propeller fan blade assembly

Prerequisite: Stop the unit operation via the user interface.

Prerequisite: Turn OFF the respective circuit breaker.

Prerequisite: Remove the required plate work, see ["4.14 Plate work"](#) [▶ 157].

- 1 If propeller fan blade touches the bell mouth, check if the fan motor is correctly mounted on its base, see ["Repair procedures"](#) [▶ 149].
- 2 Check the state of the propeller fan blade assembly for damage, deformations and cracks.

Is the propeller fan blade assembly damaged?	Action
Yes	Replace the propeller fan blade assembly, see "Repair procedures" [▶ 149].
No	Perform a mechanical check of the DC fan motor assembly, see "Checking procedures" [▶ 147].

To perform a mechanical check of the DC fan motor assembly

Prerequisite: First perform a mechanical check of the propeller fan blade assembly, see ["Checking procedures"](#) [▶ 147].

- 1 Visually check:
 - For any burnt-out part or wire. If found, replace the fan motor, see ["Repair procedures"](#) [▶ 149].
 - That fan motor fixation bolts are correctly installed and fixed. Correct as needed.
- 2 Manually rotate the fan motor shaft. Check that it rotates smoothly.
- 3 Check the friction of the DC fan motor shaft bearing.

Is the DC fan motor shaft friction normal?	Action
Yes	Perform an electrical check of the DC fan motor assembly, see "Checking procedures" [▶ 147].
No	Replace the DC fan motor assembly, see "Repair procedures" [▶ 149].

To perform an electrical check of the DC fan motor assembly

- 1 First perform a mechanical check of the DC fan motor assembly, see ["Checking procedures"](#) [▶ 147].



INFORMATION

Check the DC fan motor power supply (voltage) circuit on the PCB.

- 2 Turn ON the power of the unit.
- 3 Activate **Cooling** or **Heating** operation via the user interface.
- 4 Check the functioning of the outdoor unit fan.

Outdoor unit fan ...	Action
Rotates continuously (without interruption)	DC fan motor assembly is OK. Return to the troubleshooting of the specific error and continue with the next procedure.
Does not rotate or rotates for a short time	Continue with the next step.

- 5 Turn OFF the unit via the user interface.
- 6 Turn OFF the respective circuit breaker.



DANGER: RISK OF ELECTROCUTION

Wait for at least 10 minutes after the circuit breaker has been turned OFF, to be sure the rectifier voltage is below 10 V DC before proceeding.

- 7 Check that the DC fan motor connector is properly connected to the PCB.
- 8 Unplug the DC fan motor connector and measure the resistance between the pins 1-3, 1-5, and 3-5 of the DC fan motor connector.

Result: All measurements MUST be 51.9~57.3 Ω.

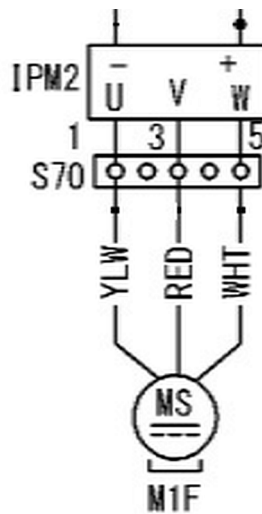

INFORMATION

Winding resistance values above are given for reference. You should NOT be reading a value in kΩ or a short-circuit. Make sure that the propeller fan blade does NOT rotate, as this could affect resistance measurements.

- 9 Set the Megger voltage to 500 V DC or 1000 V DC.
- 10 Measure the insulation resistance for the motor terminals. Measurements between each phase and fan motor body (e.g. axle) MUST be >1000 MΩ.

Are the measured resistance values correct?	Action
Yes	Perform a check of the main PCB, see "Checking procedures" [▶ 129].
No	Replace the DC fan motor, see "Repair procedures" [▶ 149].

Problem solved?

After all checking procedures listed above have been performed:

Is the problem solved?	Action
Yes	No further actions required.
No	Return to the troubleshooting of the specific error and continue with the next procedure.

Repair procedures

To remove the propeller fan blade assembly

Prerequisite: Stop the unit operation via the user interface.

Prerequisite: Turn OFF the respective circuit breaker.

- 1 Remove the required plate work, see "4.14 Plate work" [▶ 157].
- 2 Remove the nut that fixes the propeller fan blade assembly.

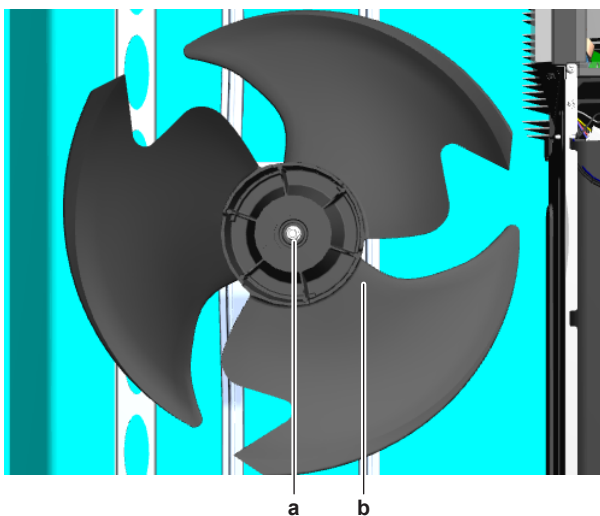

- a** Nut
b Propeller fan blade assembly

- 3 Pull and remove the propeller fan blade assembly from the DC fan motor assembly.



INFORMATION

Use a pulley remover if the propeller cannot be removed manually.

- 4 To install the propeller fan blade assembly, see "Repair procedures" [▶ 149].

To remove the DC fan motor assembly

- 1 Remove the propeller fan blade assembly from the DC fan motor assembly, see "Repair procedures" [▶ 149].

**DANGER: RISK OF ELECTROCUTION**

Wait for at least 10 minutes after the circuit breaker has been turned OFF, to be sure the rectifier voltage is below 10 V DC before proceeding.

- 2 Disconnect the DC fan motor connector from the main PCB.

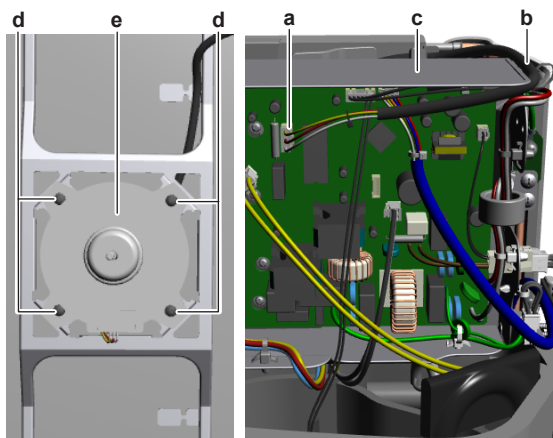

- a DC fan motor connector
- b DC fan motor harness
- c Switch box
- d Screw
- e DC fan motor assy

- 3 Detach the DC fan motor harness from the switch box.
- 4 Slightly bend the harness retainers (if applicable) to detach the DC fan motor harness.
- 5 Remove the 4 screws that fix the DC fan motor assembly.
- 6 Remove the DC fan motor assembly from the unit.
- 7 To install the DC fan motor assembly, see "[Repair procedures](#)" [▶ 149].

To install the DC fan motor assembly

- 1 Install the DC fan motor assembly in the correct location.
- 2 Fix the DC fan motor assembly to the unit by tightening the screws.

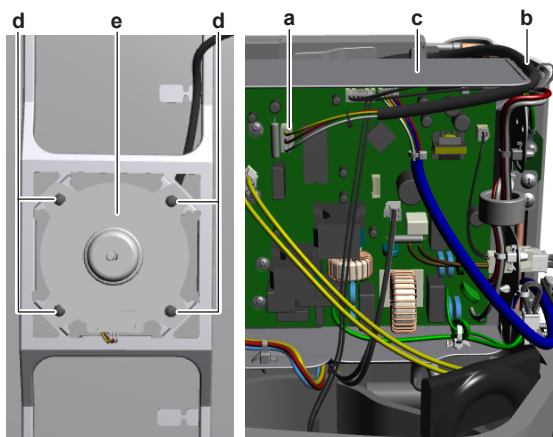

- a DC fan motor connector
- b DC fan motor harness
- c Switch box
- d Screw
- e DC fan motor assy

- 3 If applicable: Route the DC fan motor harness through the harness retainers and bend the harness retainers to attach the DC fan motor harness.

- 4 Route the DC fan motor harness upwards and attach the DC fan motor harness to the switch box.
- 5 Connect the DC fan motor connector to the connector on the main PCB.
- 6 Install the propeller fan blade assembly, see "[Repair procedures](#)" [▶ 149].

To install the propeller fan blade assembly

- 1 Install the propeller fan blade assembly on the DC fan motor assembly.



CAUTION

Do NOT install a damaged propeller fan blade assembly.

- 2 Install and tighten the nut to fix the propeller fan blade assembly.

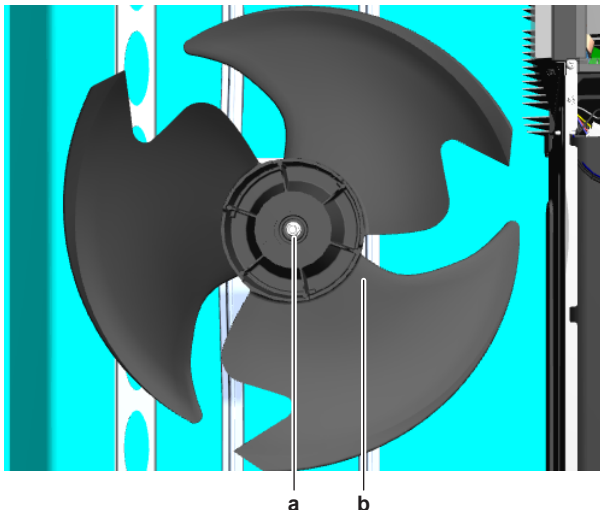

- a Nut
b Propeller fan blade assembly

Is the problem solved?	Action
Yes	No further actions required.
No	Return to " Checking procedures " [▶ 147] of the outdoor unit fan motor and continue with the next procedure.

4.13.2 Class 42~71 units

Checking procedures



INFORMATION

It is recommended to perform the checks in the listed order.

To perform a mechanical check of the propeller fan blade assembly

Prerequisite: Stop the unit operation via the user interface.

Prerequisite: Turn OFF the respective circuit breaker.

Prerequisite: Remove the required plate work, see "[4.14 Plate work](#)" [▶ 157].

- 1 If propeller fan blade touches the bell mouth, check if the fan motor is correctly mounted on its base, see "[Repair procedures](#)" [▶ 154].

- 2 Check the state of the propeller fan blade assembly for damage, deformations and cracks.

Is the propeller fan blade assembly damaged?	Action
Yes	Replace the propeller fan blade assembly, see "Repair procedures" [▶ 154].
No	Perform a mechanical check of the DC fan motor assembly, see "Checking procedures" [▶ 151].

To perform a mechanical check of the DC fan motor assembly

Prerequisite: First perform a mechanical check of the propeller fan blade assembly, see ["Checking procedures"](#) [▶ 151].

- 1 Visually check:
 - For any burnt-out part or wire. If found, replace the fan motor, see ["Repair procedures"](#) [▶ 154].
 - That fan motor fixation bolts are correctly installed and fixed. Correct as needed.
- 2 Manually rotate the fan motor shaft. Check that it rotates smoothly.
- 3 Check the friction of the DC fan motor shaft bearing.

Is the DC fan motor shaft friction normal?	Action
Yes	Perform an electrical check of the DC fan motor assembly, see "Checking procedures" [▶ 151].
No	Replace the DC fan motor assembly, see "Repair procedures" [▶ 154].

To perform an electrical check of the DC fan motor assembly

- 1 First perform a mechanical check of the DC fan motor assembly, see ["Checking procedures"](#) [▶ 151].



INFORMATION
Check the DC fan motor power supply (voltage) circuit on the PCB.

- 2 Turn ON the power of the unit.
- 3 Activate **Cooling** or **Heating** operation via the user interface.
- 4 Check the functioning of the outdoor unit fan.

Outdoor unit fan ...	Action
Rotates continuously (without interruption)	DC fan motor assembly is OK. Return to the troubleshooting of the specific error and continue with the next procedure.
Does not rotate or rotates for a short time	Continue with the next step.



INFORMATION
The DC fan motor connector **MUST** be plugged into the appropriate PCB.

- 5 Confirm via the service monitoring tool that the DC fan motor assembly receives an ON signal.
- 6 Turn OFF the unit via the user interface.
- 7 Turn OFF the respective circuit breaker.

**DANGER: RISK OF ELECTROCUTION**

Wait for at least 10 minutes after the circuit breaker has been turned OFF, to be sure the rectifier voltage is below 10 V DC before proceeding.

- 8 Disconnect the DC fan motor connector S70 and measure the resistance on the connector pins shown below. The measured resistance MUST be:

VDC	Comm	Resistance
1	4	>1 MΩ
2	4	>100 kΩ
3	4	>100 Ω
7	4	>100 kΩ

**INFORMATION**

The measured resistance values may deviate from the listed values due to instability during the measurements.

DC fan motor resistance measurements are correct?	Action
Yes	Continue with the next step.
No	Replace the DC fan motor, see " Repair procedures " [▶ 154].

- 9 Turn ON the power of the unit.
- 10 With the DC fan motor connector S70 disconnected from the main PCB, measure the voltage on the connector pins 4-7 (= fan motor power supply) on the main PCB.

Result: The voltage MUST be:

Unit	Voltage
Class 42~60 + ARXM71R	200~390 V DC
RXM71R	342~408 V DC

- 11 Measure the voltage on the connector pins 4-3 (= fan motor control) on the main PCB.

Result: The voltage MUST be 15±10% V DC.

Are both measured voltages correct?	Action
Yes	Continue with the next step.
No	Perform a check of the main PCB, see " Checking procedures " [▶ 139].

- 12 Measure the voltage on the DC fan motor connector S70 pins 2-4 (= rotation command) on the PCB.

Result: The measured voltage should be 0~7.5 V DC. It should NOT be 0 V DC.

Is the measured voltage 0 V DC?	Action
Yes	Perform a check of the main PCB, see "Checking procedures" [▶ 139].
No	Continue with the next step.

13 Connect the DC fan motor connector to the PCB. Remove the plastic insert from the connector for easier measurement.



CAUTION
Ensure that the system CANNOT start the fan. Disable all modes (heating, cooling, ...) on the unit. The unit MUST be kept powered.

14 Manually (slowly) rotate the fan blade propeller 1 turn and measure the voltage on the DC fan motor connector pins 1-4.

Result: 4 pulses MUST be measured.

Pulses are measured during fan blade propeller rotation?	Action
Yes	Perform a check of the main PCB, see "Checking procedures" [▶ 139].
No	Replace the DC fan motor, see "Repair procedures" [▶ 154].

Problem solved?

After all checking procedures listed above have been performed:

Is the problem solved?	Action
Yes	No further actions required.
No	Return to the troubleshooting of the specific error and continue with the next procedure.

Repair procedures

To remove the propeller fan blade assembly

Prerequisite: Stop the unit operation via the user interface.

Prerequisite: Turn OFF the respective circuit breaker.

- 1** Remove the required plate work, see ["4.14 Plate work"](#) [▶ 157].
- 2** Remove the nut that fixes the propeller fan blade assembly.

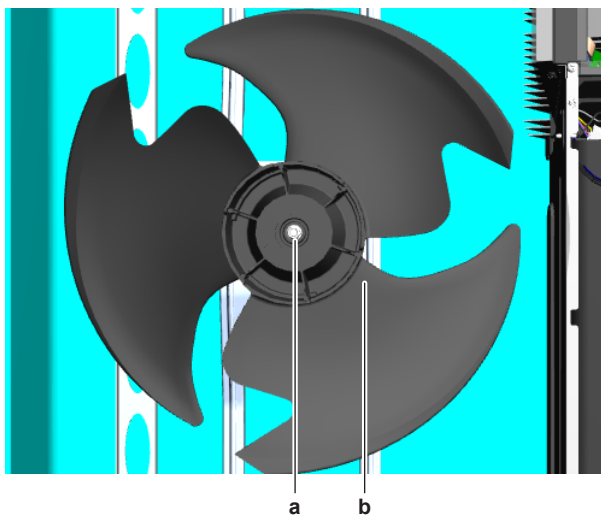

- a Nut
- b Propeller fan blade assembly

- 3 Pull and remove the propeller fan blade assembly from the DC fan motor assembly.



INFORMATION

Use a pulley remover if the propeller cannot be removed manually.

- 4 To install the propeller fan blade assembly, see "[Repair procedures](#)" [▶ 154].

To remove the DC fan motor assembly

- 1 Remove the propeller fan blade assembly from the DC fan motor assembly, see "[Repair procedures](#)" [▶ 154].



DANGER: RISK OF ELECTROCUTION

Wait for at least 10 minutes after the circuit breaker has been turned OFF, to be sure the rectifier voltage is below 10 V DC before proceeding.

- 2 Disconnect the DC fan motor connector from the main PCB.
- 3 Cut the tie strap.

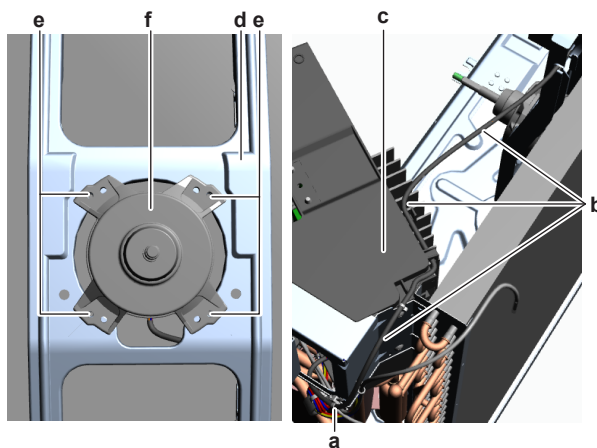

- a Tie strap
- b DC fan motor harness
- c Switch box
- d Fan motor bracket
- e Screw
- f DC fan motor assembly

- 4 Detach the DC fan motor harness from the switch box.
- 5 Slightly bend the harness retainers (at the back of the fan motor bracket) to detach the DC fan motor harness.
- 6 Remove the 4 screws that fix the DC fan motor assembly.
- 7 Remove the DC fan motor assembly from the unit.
- 8 To install the DC fan motor assembly, see "[Repair procedures](#)" [▶ 154].

To install the DC fan motor assembly

- 1 Install the DC fan motor assembly in the correct location.
- 2 Fix the DC fan motor assembly to the unit by tightening the screws.

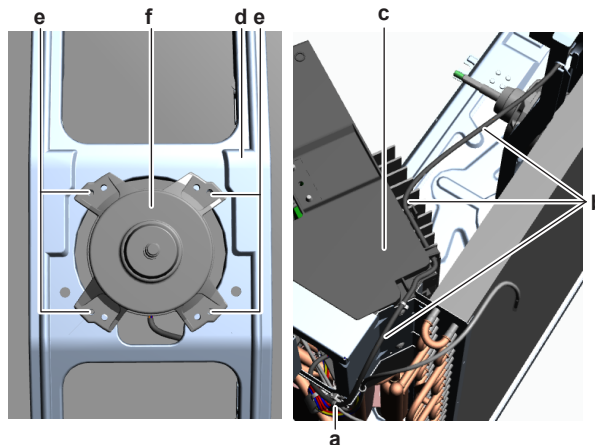

- a Tie strap
- b DC fan motor harness
- c Switch box
- d Fan motor bracket
- e Screw
- f DC fan motor assembly

- 3 Route the DC fan motor harness through the harness retainers (at the back of the fan motor bracket) and bend the harness retainers to attach the DC fan motor harness.
- 4 Attach the DC fan motor harness to the switch box.
- 5 Install a new tie strap to fix the DC fan motor harness to the switch box.
- 6 Connect the DC fan motor connector to the connector on the main PCB.
- 7 Install the propeller fan blade assembly, see "[Repair procedures](#)" [▶ 154].

To install the propeller fan blade assembly

- 1 Install the propeller fan blade assembly on the DC fan motor assembly.



CAUTION
Do NOT install a damaged propeller fan blade assembly.

- 2 Install and tighten the nut to fix the propeller fan blade assembly.

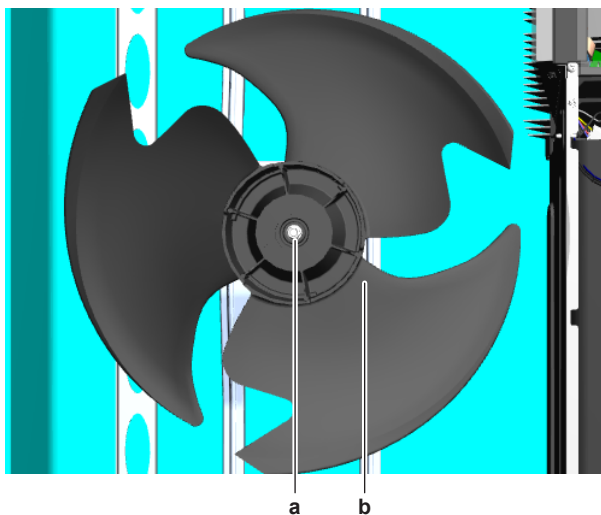

- a Nut
- b Propeller fan blade assembly

Is the problem solved?	Action
Yes	No further actions required.
No	Return to " Checking procedures " [▶ 151] of the outdoor unit fan motor and continue with the next procedure.

4.14 Plate work

4.14.1 Outdoor unit

To remove the refrigerant connection cover



DANGER: RISK OF ELECTROCUTION



DANGER: RISK OF BURNING/SCALDING

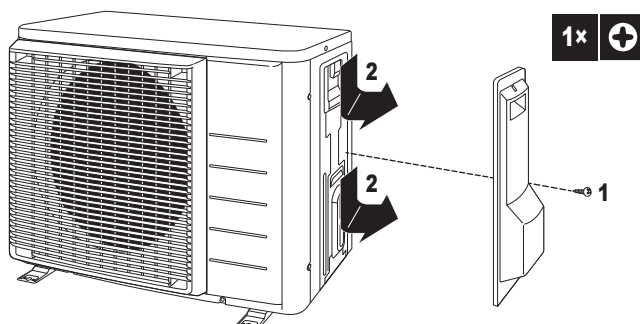

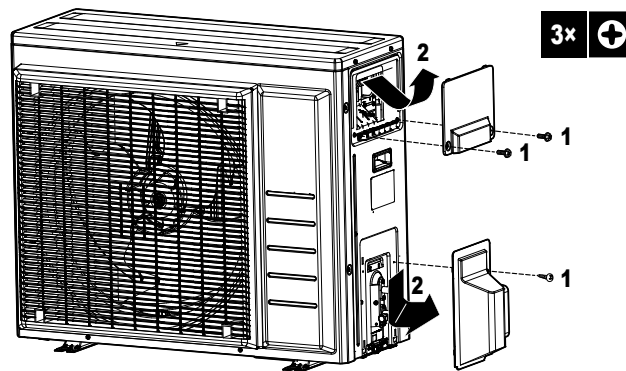

To remove the top plate



INFORMATION

This procedure is just an example and may differ on some details for your actual unit.

Prerequisite: Stop the unit operation via the user interface.

- 1 Turn OFF the respective circuit breaker.



DANGER: RISK OF ELECTROCUTION

Wait for at least 10 minutes after the circuit breaker has been turned OFF, to be sure the rectifier voltage is below 10 V DC before proceeding.

- 2 Loosen and remove the screws that fix the top plate.

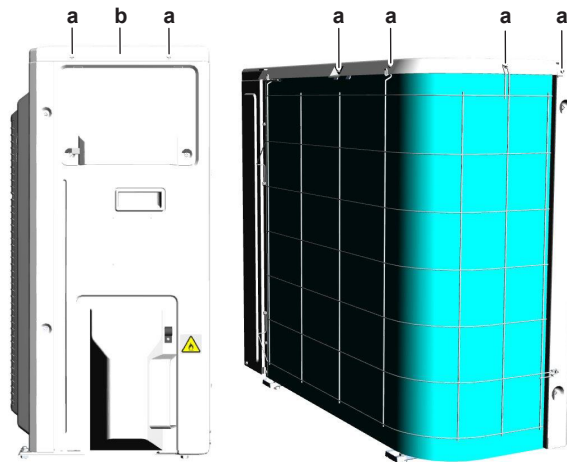

- a Screw
- b Top plate

- 3 Remove the top plate.

To remove the front plate



INFORMATION

This procedure is just an example and may differ on some details for your actual unit.

Prerequisite: Remove the top plate, see "4.14 Plate work" [▶ 157].

- 1 Loosen and remove the screws that fix the front plate.

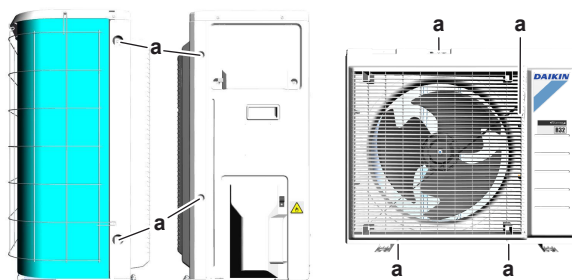

- a Screw
- b Front plate

- 2 Remove the front plate.

To remove the switch box



INFORMATION

This procedure is just an example and may differ on some details for your actual unit.

Prerequisite: Stop the unit operation via the user interface.

Prerequisite: Turn OFF the respective circuit breaker.

Prerequisite: Remove the required plate work, see "[4.14 Plate work](#)" [▶ 157].

- 1 Remove the insulation on the upper side of the switch box.

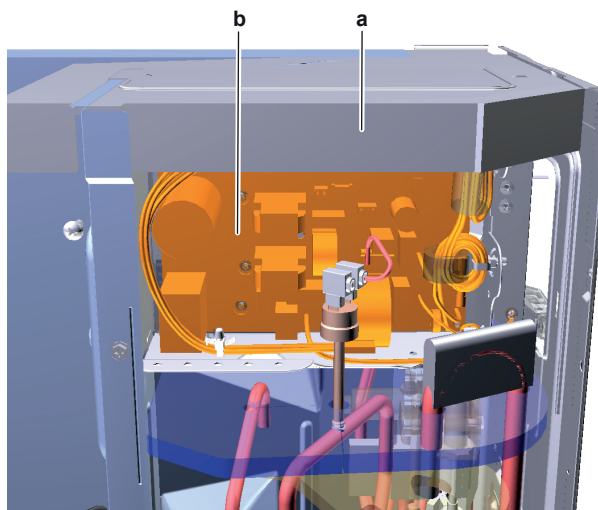

- a Insulation
- b Main PCB

- 2 Disconnect all connectors from the main PCB.
- 3 Disconnect the electrical power supply wiring from the wire terminals.

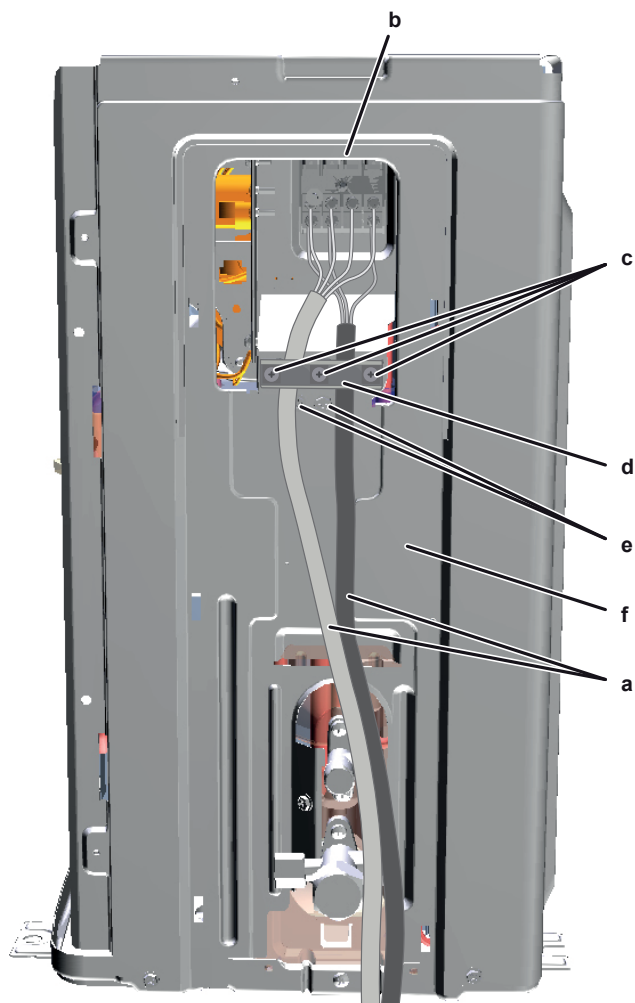

- a** Electrical power supply wiring
- b** Wire terminals
- c** Screws
- d** Wire clamp
- e** Screws
- f** Right side plate assembly

- 4** Remove the screws that fix the wire clamp.
- 5** Remove the wire clamp.
- 6** Remove the screws that fix the right side plate assembly.
- 7** Cut the cable tie.

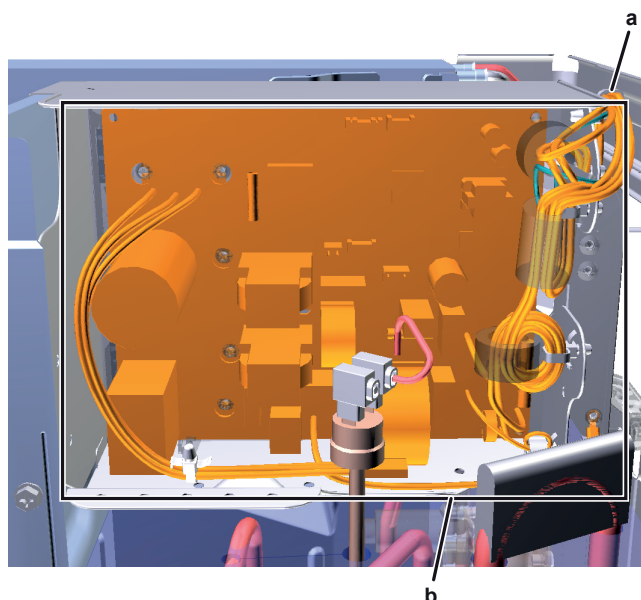

- a Cable tie
- b Switch box

- 8 Lift and remove the switch box from the outdoor unit.
- 9 To install the switch box, see "[4.14 Plate work](#)" [[▶ 157](#)].

To install the switch box



INFORMATION

This procedure is just an example and may differ on some details for your actual unit.

- 1 Install the switch box on the correct location in the outdoor unit.
- 2 Install the right side plate assembly on the outdoor unit and fix it using the screws.

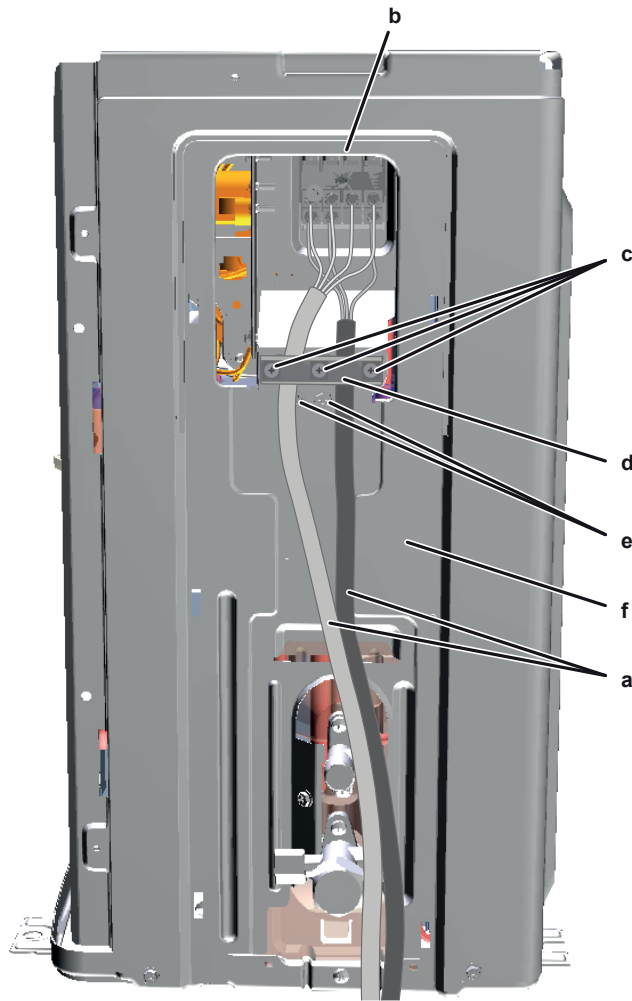

- a Electrical power supply wiring
- b Wire terminals
- c Screws
- d Wire clamp
- e Screws
- f Right side plate assembly

- 3 Connect the electrical power supply wiring to the wire terminals.
- 4 Install the wire clamp and fix it using the screws.
- 5 Connect all connectors to the main PCB.



INFORMATION

Use the wiring diagram and connection diagram for correct installation of the connectors, see "7.2 Wiring diagram" [▶ 235].



WARNING

When reconnecting a connector to the PCB, make sure to connect it on the correct location and do NOT apply force, as this may damage the connector or connector pins of the PCB.

- 6 Fix the wiring to the switch box using a new cable tie.

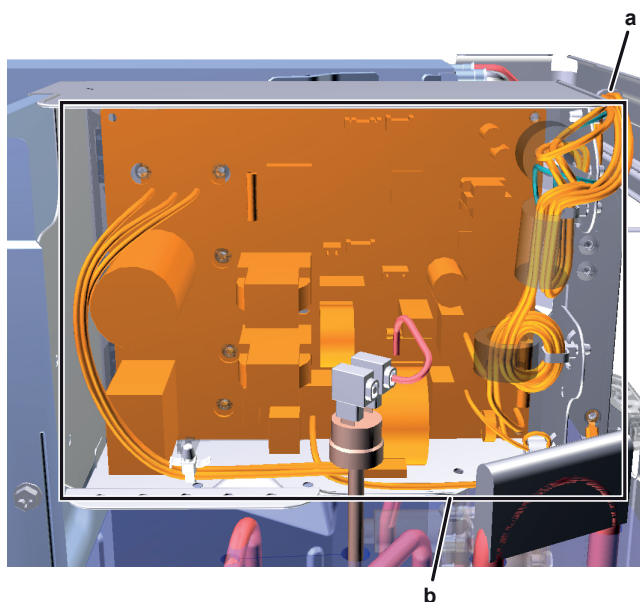

- a Cable tie
- b Switch box

7 Install the insulation on the upper side of the switch box.

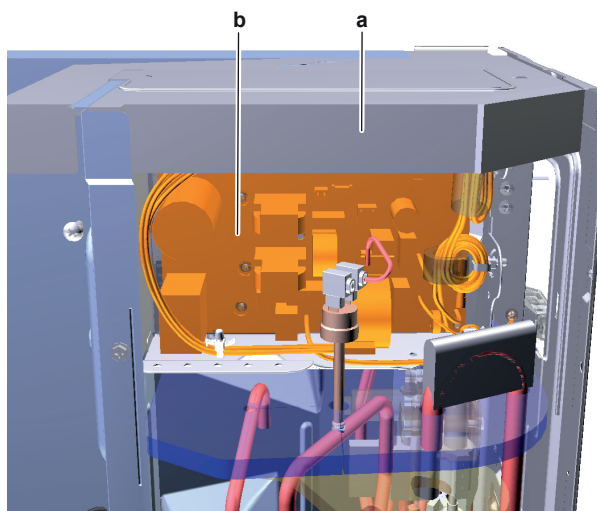

- a Insulation
- b Main PCB

4.14.2 Indoor unit

To open the front panel

ATXM-R and FTXM-R units

1 Hold the front panel by the panel tabs on both sides and open it.

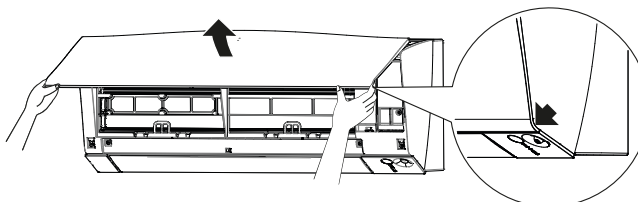

Floor standing units

1 Slide both sliders in the direction of the arrows until they click.

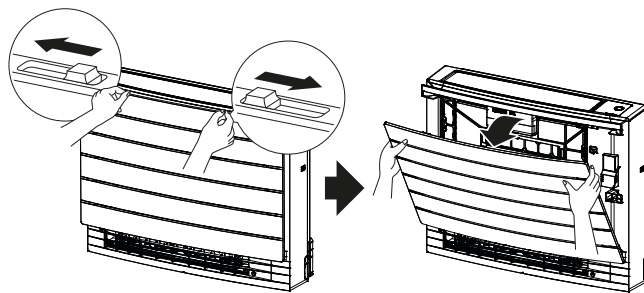

- 2 Open the front panel.

To close the front panel

ATXM-R and FTXM-R units

- 1 Set the filters as they were.
- 2 Gently press the front panel at both sides and at the center until it clicks.

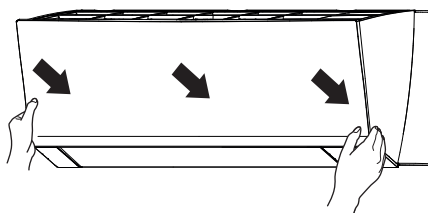

Floor standing units

- 1 Close the front panel and slide both sliders until they click.

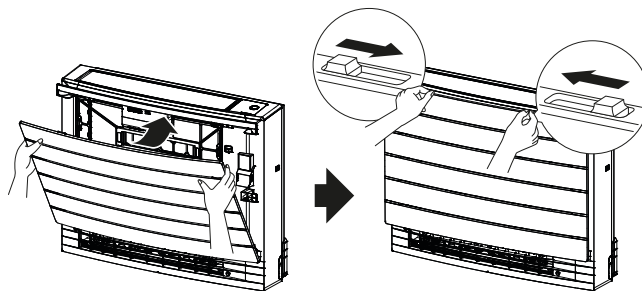

To remove the front panel

ATXM-R and FTXM-R units

- 1 Open the front panel, see "4.14 Plate work" [▶ 157].
- 2 Remove the front panel by sliding it to the left or the right and pulling it toward you.

Result: The front panel shaft on 1 side will be disconnected.

- 3 Disconnect the front panel shaft on the other side in the same manner.

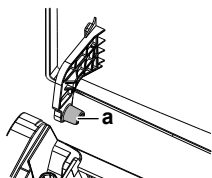

a Front panel shaft

Floor standing units

- 1 Open the front panel, see "4.14 Plate work" [▶ 157].
- 2 Remove the string.

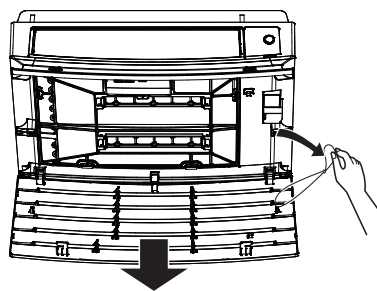

- 3 Remove the front panel.

To remove the front grille

ATXM-R and FTXM-R units



CAUTION

Wear adequate personal protective equipment (protective gloves, safety glasses,...) when installing, maintaining or servicing the system.

- 1 Remove the front panel to remove the air filter.
- 2 **For class 50~71** remove the flap (horizontal blade). Push the blade on its left side to the centre and unhook it. Push blade on its right side to centre to unhook it from shaft. Disconnect the 2 centre connection points.

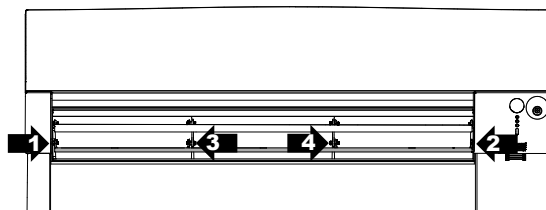

- 3 Remove 2 screws (class 15~42) or 3 screws (class 50~71) from the front grille.
- 4 Push down the 3 upper hooks marked with a symbol with 3 circles.

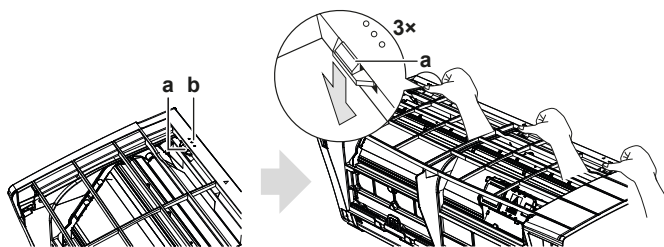

- a Upper hook
b Symbol with 3 circles

- 5 We recommend opening the flap before removing the front grille.
- 6 Place both hands under the centre of the front grille, push it up and then toward you.

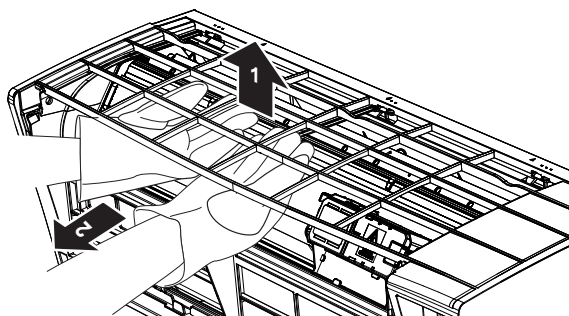

Floor standing units

- 1 Remove the front panel. See "4.14 Plate work" [▶ 157].
- 2 Remove the 4 screws, remove the grille from 4 tabs on the top and remove the front grille while pulling it toward you.

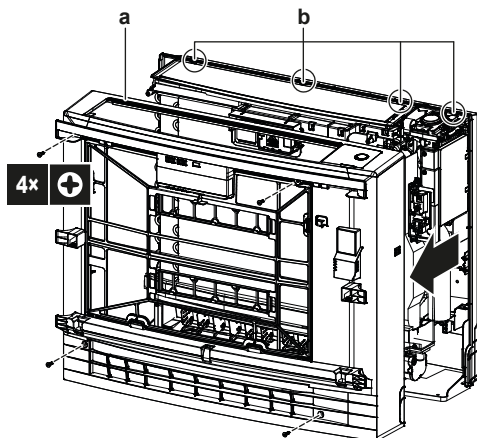

a Front grille
b Tabs

To remove the electrical wiring box cover

ATXM-R and FTXM-R units

TO OPEN THE SERVICE COVER

- 1 Remove 1 screw from the service cover.
- 2 Pull out the service cover horizontally away from the unit.

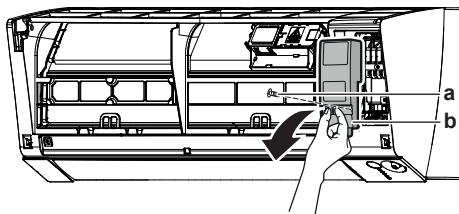

a Service cover screw
b Service cover



NOTICE

When closing the service cover, make sure that the tightening torque does NOT exceed 1.4 (± 0.2) N•m.

TO REMOVE THE ELECTRICAL WIRING BOX COVER

Prerequisite: Remove the front grille.

- 1 Remove 1 screw from the electrical wiring box.
- 2 Open the electrical wiring box cover by pulling the protruding part on the top of the cover.
- 3 Unhook the tab(s) on the bottom and remove the electrical wiring box cover.

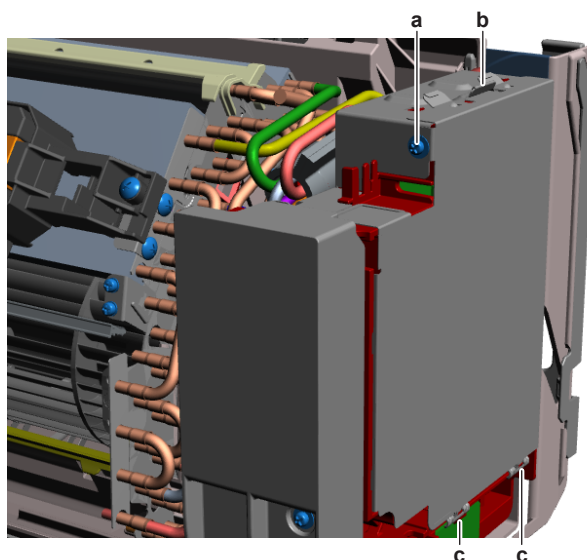

- a Screw
- b Protruding part on the top of the cover
- c Tab

Floor standing units

TO OPEN THE TERMINAL BLOCK

- 1 Remove the front grille.
- 2 Remove 1 lower screw.
- 3 Lift the sensor securing plate.
- 4 Move the metal plate cover down and then towards you to remove it.

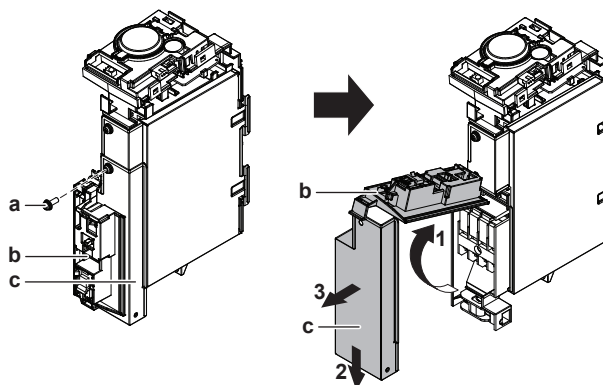

- a Screw
- b Sensor securing plate
- c Metal plate cover

TO REMOVE THE ELECTRICAL WIRING BOX COVER

Prerequisite: Open the terminal block.

- 1 Remove 1 screw from the electrical wiring box.
- 2 Unhook the 2 tabs on the electrical wiring box cover and remove it.

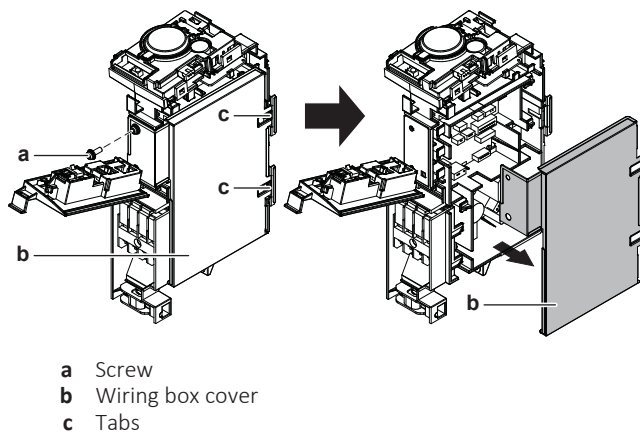

- a Screw
- b Wiring box cover
- c Tabs

To remove the switch box

ATXM-R and FTXM-R units

Prerequisite: Stop the unit operation via the user interface.

Prerequisite: Turn OFF the respective circuit breaker.

Prerequisite: Remove the required plate work, see "4.14 Plate work" [▶ 157].

- 1 Disconnect the power supply wiring from the power supply terminal X1M.
- 2 Remove the screw and power supply wiring bracket.
- 3 Pull the clip and remove the heat exchanger thermistor from its holder.
- 4 Remove the screw to disconnect the grounding wire from the heat exchanger.

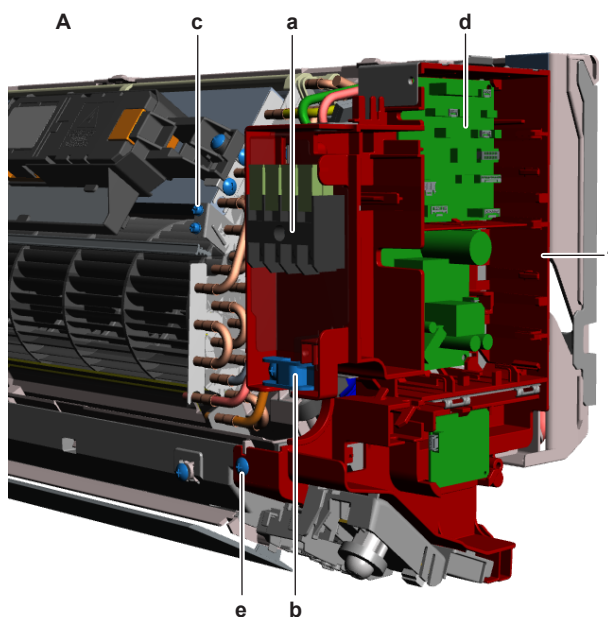

- A Class 20~42 unit
- a Power supply terminal X1M
- b Power supply wiring bracket
- c Screw (ground wire)
- d Indoor unit main PCB
- e Switch box screw
- f Switch box

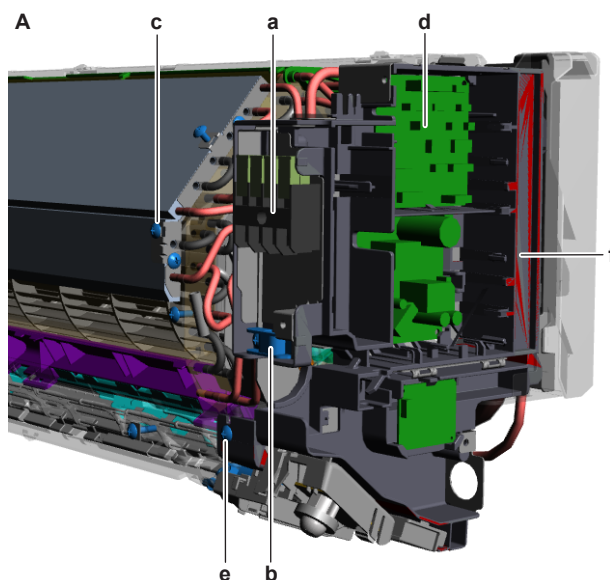

- A Class 50~71 unit
- a Power supply terminal X1M
- b Power supply wiring bracket
- c Screw (ground wire)
- d Indoor unit main PCB
- e Switch box screw
- f Switch box

- 5 Disconnect the connectors of the indoor unit fan motor, the swing flap motor, the swing raster motor and the streamer unit from the indoor unit main PCB.
- 6 Detach these wiring harnesses from the switch box.
- 7 Remove the screw and remove the switch box from the indoor unit.
- 8 To install the switch box, see ["4.14 Plate work"](#) [▶ 157].

Floor standing indoor units

Prerequisite: Stop the unit operation via the user interface.

Prerequisite: Turn OFF the respective circuit breaker.

Prerequisite: Remove the required plate work, see ["4.14 Plate work"](#) [▶ 157].

- 1 Disconnect the power supply wiring from the power supply terminal X1M.
- 2 Remove the screw and power supply wiring bracket.

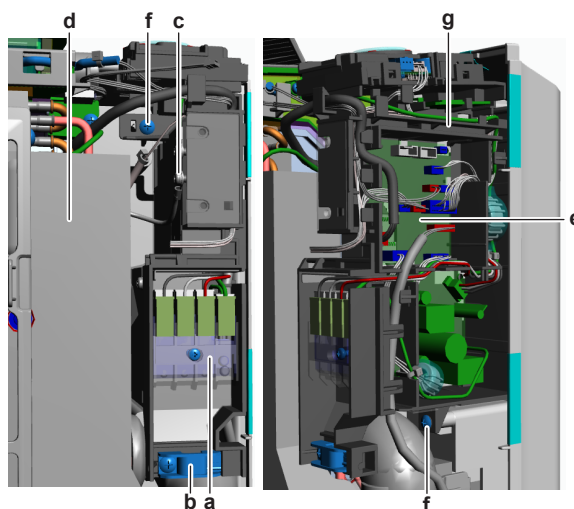

- a Power supply terminal X1M
- b Power supply wiring bracket
- c Screw (ground wire)

- d** Plate
- e** Indoor unit main PCB
- f** Switch box screw
- g** Switch box

- 3** Remove the screw to disconnect the grounding wire from the back side of the switch box.
- 4** Remove the screw and remove the plate from the indoor unit heat exchanger to create access to the heat exchanger thermistor.
- 5** Remove the air and heat exchanger thermistors from their holders.
- 6** Disconnect the connectors of the indoor unit fan motor, the swing flap motor, the damper motor and the streamer unit from the indoor unit main PCB.
- 7** Detach these wiring harnesses from the switch box.
- 8** Remove the two screws and remove the switch box from the indoor unit.
- 9** To install the switch box, see "4.14 Plate work" [▶ 157].

To re-install the front grille

ATXM-R and FTXM-R units

- 1** Install the front grille and firmly engage the 3 upper hooks.
- 2** Install 2 screws (class 15~42) or 3 screws (class 50~71) back on the front grille.
- 3** **For class 50~71** re-install the lower flap (horizontal blade). Connect the 2 centre connection points. Hook the right side of the blade to the shaft. Hook the blade on its left side.
- 4** Install the air filter, mount the front panel and close it.

Floor standing units

- 1** Attach the front grille to the original position.
- 2** Secure the front grille in 4 tabs.
- 3** Secure with the 2 original screws on the top part and with the 2 white head screws (accessory) on the bottom part.

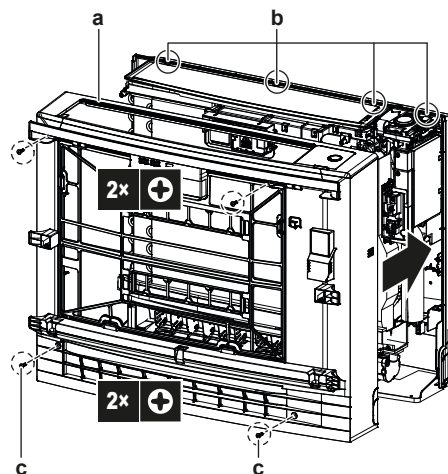

- a** Front grille
- b** 4 tabs
- c** White head screws (accessory)

To re-install the front panel

ATXM-R and FTXM-R units

- 1 Attach the front panel. Align the shafts with the slots and push them all the way in.
- 2 Close the front panel, see "4.14 Plate work" [▶ 157].

Floor standing units

- 1 Insert the front panel into the grooves of the unit (3 places) and attach the string.

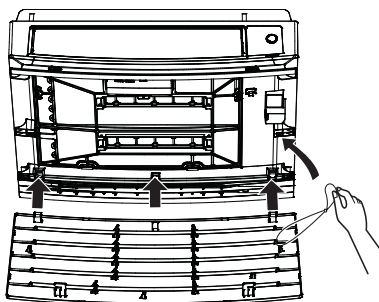

- 2 Close the front panel, see "4.14 Plate work" [▶ 157].

To install the switch box

ATXM-R and FTXM-R units

- 1 install the switch box in the correct location on the indoor unit.

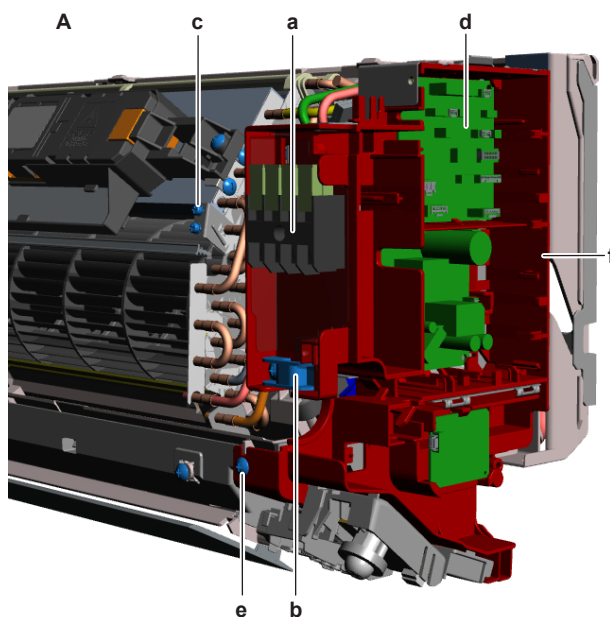

- A Class 20~42 unit
- a Power supply terminal X1M
- b Power supply wiring bracket
- c Screw (ground wire)
- d Indoor unit main PCB
- e Switch box screw
- f Switch box

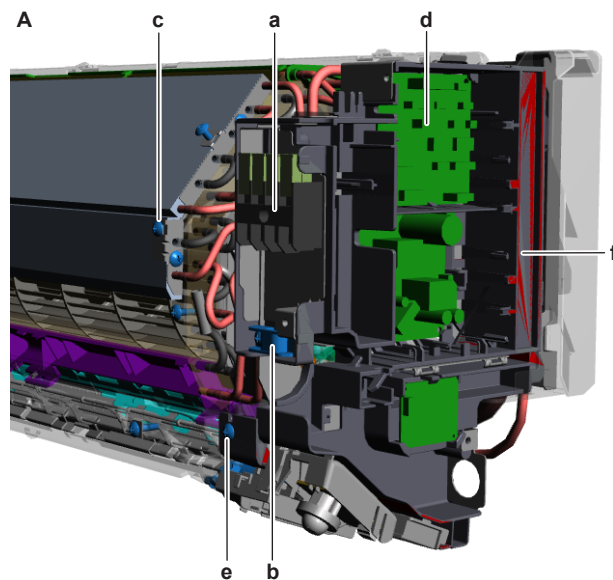

- A Class 50~71 unit
- a Power supply terminal X1M
- b Power supply wiring bracket
- c Screw (ground wire)
- d Indoor unit main PCB
- e Switch box screw
- f Switch box

- 2 Route the connectors of the indoor unit fan motor, swing flap motor, swing raster motor and streamer unit inside the switch box and connect them to the indoor unit main PCB.
- 3 Install and tighten the screw to secure the switch box.
- 4 Install the heat exchanger thermistor in its holder.
- 5 Attach the wiring harnesses to the switch box as needed.
- 6 Connect the grounding wire to the heat exchanger using the screw.
- 7 Connect the power supply wiring to the power supply terminal X1M.
- 8 Install the power supply wiring bracket. Install and tighten the screw.

Floor standing indoor units

- 1 install the switch box in the correct location on the indoor unit.

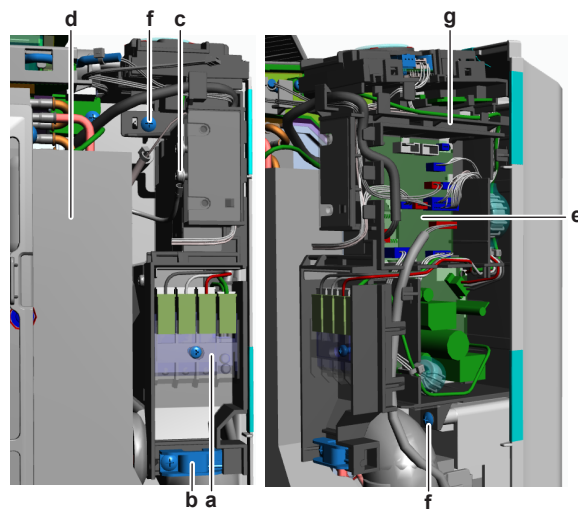

- a Power supply terminal X1M
- b Power supply wiring bracket
- c Screw (ground wire)
- d Plate

- e Indoor unit main PCB
- f Switch box screw
- g Switch box

- 2 Route the connectors of the indoor unit fan motor, swing flap motor, damper motor, streamer unit and thermistors (air + heat exchanger) inside the switch box and connect them to the indoor unit main PCB.
- 3 Install and tighten the two screws to secure the switch box.
- 4 Attach the wiring harnesses to the switch box as needed.
- 5 Install the air and heat exchanger thermistor in their holders.
- 6 Connect the grounding wire to the back side of the switch box using the screw.
- 7 Install the plate and fix it to the indoor unit heat exchanger using the screw.
- 8 Connect the power supply wiring to the power supply terminal X1M.
- 9 Install the power supply wiring bracket. Install and tighten the screw.

4.15 R32 leak detection sensor

4.15.1 Checking procedures

To perform an electrical check of the R32 leak detection sensor

Prerequisite: Stop the unit operation via the user interface.

Prerequisite: Turn OFF the respective circuit breaker.

- 1 Remove the required plate work, see "[4.14 Plate work](#)" [▶ 157].



DANGER: RISK OF ELECTROCUTION

Wait for at least 10 minutes after the circuit breaker has been turned OFF, to be sure the rectifier voltage is below 10 V DC before proceeding.

- 2 Disconnect the R32 leak detection sensor connector S903 from the indication LED PCB.
- 3 On the disconnected connector, using a multimeter in diode check, measure in reference with the table below.

VDC	COM	REF	VDC	COM	REF
Pin 1	Pin3	2.921~3.568 V	Pin3	Pin 1	OL
Pin 1	Pin 2	0 V	Pin 2	Pin 1	0 V
Pin3	Pin 2	OL	Pin 2	Pin3	2.921~3.568 V

Measured values are correct?	Action
Yes	Continue with the next step.
No	Replace the R32 leak detection sensor, see " 4.15.2 Repair procedures " [▶ 174].

- 4 Connect the R32 leak detection sensor connector to the indication LED PCB.
- 5 Turn ON the power using the respective circuit breaker.
- 6 Start the unit operation via the user interface.
- 7 Activate Cooling operation via the user interface.
- 8 Wait until the unit is operating properly and make sure NO R32 leak is present.

- 9** Measure the voltage between pin 1 (N wire) and pin 3 (power supply wire) on connector S903 on the indication LED PCB.

Result: The measured voltage MUST be 12.15~14.85 V DC.

Is the measured voltage correct?	Action
Yes	Continue with the next step.
No	Perform a check of the indoor unit main PCB, see " 4.9.1 Checking procedures " [▶ 110].

- 10** Measure the voltage between pin 1 (N wire) and pin 2 (R32 leak detection wire) on connector S903 on the indication LED PCB.

Result: The measured voltage MUST be 0.5~4.5 V DC.

Does the leak detection sensor function correctly?	Action
Yes	Return to troubleshooting of the specific error code and continue with the next procedure.
No	Replace the leak detection sensor, see " 4.15.2 Repair procedures " [▶ 174].

4.15.2 Repair procedures

To remove the R32 leak detection sensor

Prerequisite: Stop the unit operation via the user interface.

Prerequisite: Turn OFF the respective circuit breaker.

Prerequisite: Remove the required plate work, see "[4.14 Plate work](#)" [▶ 157].

Prerequisite: Remove the switch box cover; see "[4.14 Plate work](#)" [▶ 157].

- 1** Disconnect the R32 leak detection sensor connector from the indication LED PCB.
- 2** Route the R32 leak detection sensor wiring harness out of ALL harness retainers.
- 3** Release the damper motor wiring harness from the bottom of the R32 leak detection sensor assembly.
- 4** Remove the screw and from the R32 leak detection sensor assembly.

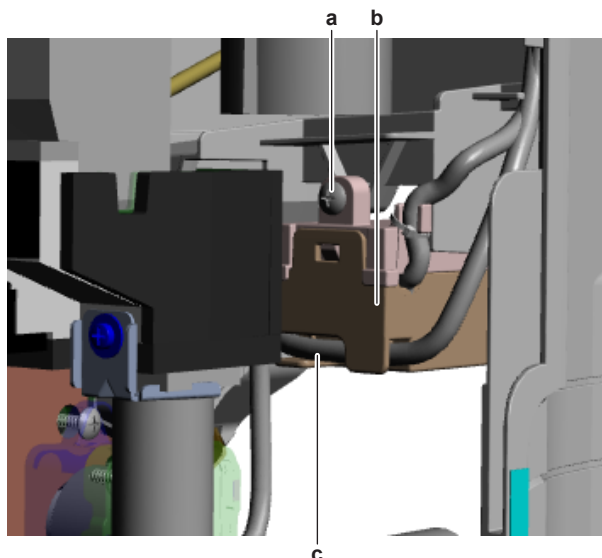

- a Screw
- b R32 leak detection sensor assy
- c Damper motor wiring harness

- 5 Remove the complete R32 leak detection sensor assembly from the unit.
- 6 To install the R32 leak detection sensor, see "[4.15.2 Repair procedures](#)" [▶ 174].

To install the R32 leak detection sensor

- 1 Install the R32 leak detection sensor assembly in the correct location on the unit. Make sure the damper motor wiring harness is routed in the correct location (bottom side of the R32 leak detection sensor assembly).
- 2 Install and tighten the screw to fix the R32 leak detection sensor assembly.

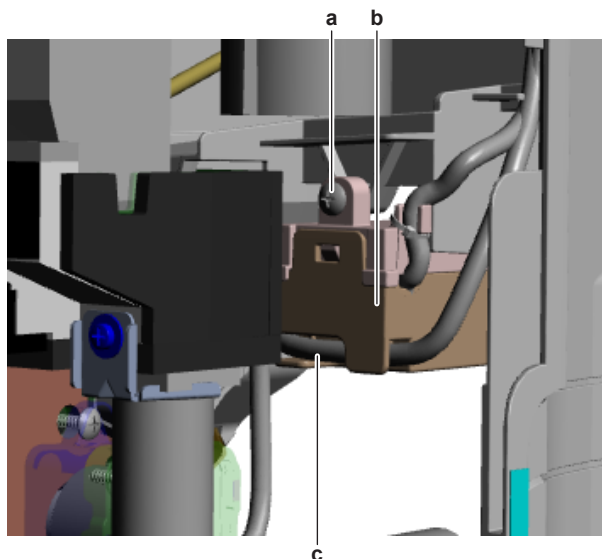

- a Screw
- b R32 leak detection sensor assy
- c Damper motor wiring harness

- 3 Attach the damper motor wiring harness to the bottom of the R32 leak detection sensor assembly.
- 4 Route the R32 leak detection sensor wiring harness through ALL appropriate harness retainers towards the indication LED PCB.
- 5 Connect the R32 leak detection sensor connector to the indication LED PCB.



WARNING

When reconnecting a connector to the PCB, make sure to connect it on the correct location and do NOT apply force, as this may damage the connector or connector pins of the PCB.

Is the problem solved?	Action
Yes	No further actions required.
No	Return to the troubleshooting of the specific error and continue with the next procedure.

4.16 Reactor

4.16.1 Checking procedures

To perform an electrical check of the reactor

Prerequisite: Stop the unit operation via the user interface.

Prerequisite: Turn OFF the respective circuit breaker.

- 1 Remove the required plate work, see ["4.14 Plate work"](#) [▶ 157].



DANGER: RISK OF ELECTROCUTION

Wait for at least 10 minutes after the circuit breaker has been turned OFF, to be sure the rectifier voltage is below 10 V DC before proceeding.

- 2 Visually check the reactor for any damage or burnt-out components. If any damage is found, replace the reactor, see ["4.16.2 Repair procedures"](#) [▶ 179].

Class 20~35 units

- 1 Check that the reactors are firmly installed on the main PCB.

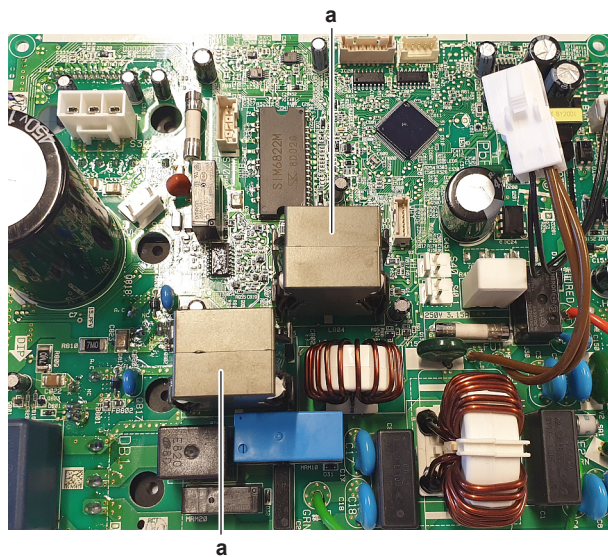

a Reactor

- 2 Remove the main PCB, see ["Repair procedures"](#) [▶ 137]. The reactor measuring points are ONLY reachable on the back side of the main PCB.

3 Measure the resistance of the reactor using a low ohm multi meter.

Result: The resistance MUST be as follows:

Measuring points	Resistance
c	24~36 mΩ
d	68~102 mΩ

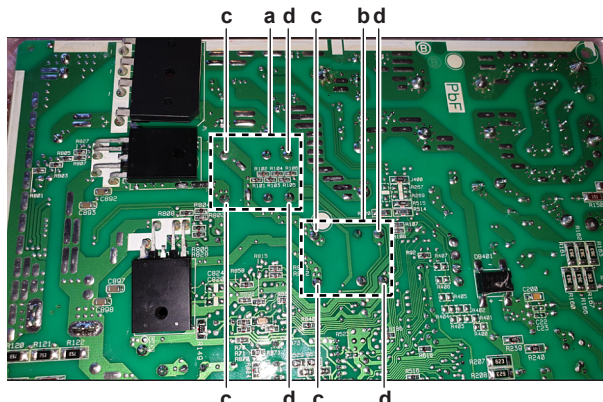

- a L803
- b L804
- c Measuring point
- d Measuring point

Is the resistance measurement correct?	Action
Yes	Proceed with the next step.
No	Replace the reactor, see "4.16.2 Repair procedures" [▶ 179].

4 Measure the inductance of the reactor using an LCR meter.

Result: The inductance MUST be 80~100 μH.

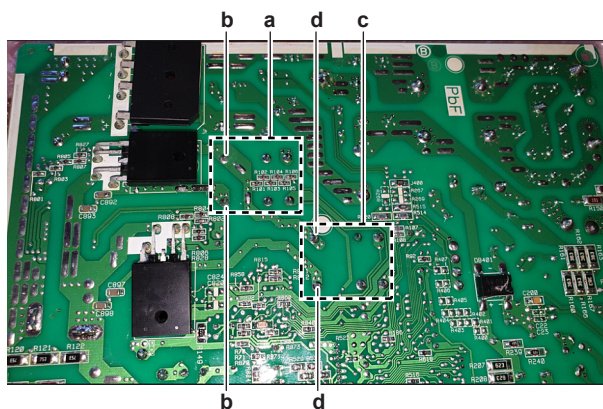

- a L803
- b L803 measuring point
- c L804
- d L804 measuring point

Is the inductance measurement correct?	Action
Yes	Return to the troubleshooting of the specific error and continue with the next step.
No	Replace the reactor, see "4.16.2 Repair procedures" [▶ 179].

Class 42~71 units

- 1 Check that the reactors are firmly installed on the main PCB.

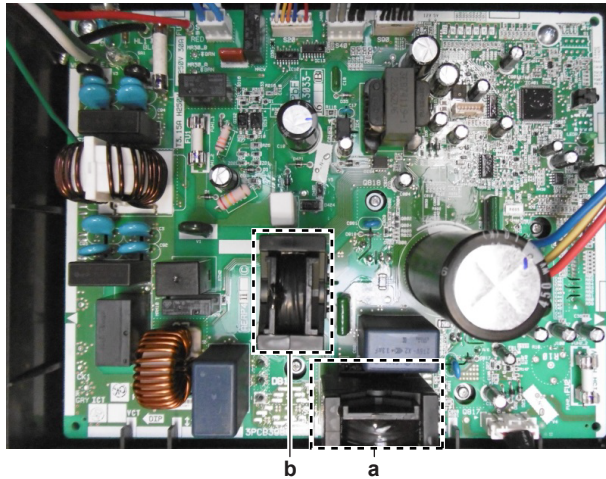

- a Reactor L803
- b Reactor L804

- 2 Remove the main PCB, see "[Repair procedures](#)" [▶ 144]. The reactor measuring points are ONLY reachable on the back side of the main PCB.
- 3 Measure the resistance of the reactor using a low ohm multi meter.

Result: The resistance MUST be as follows:

Measuring points	Resistance
c-d	20~30 mΩ
e	152~228 mΩ

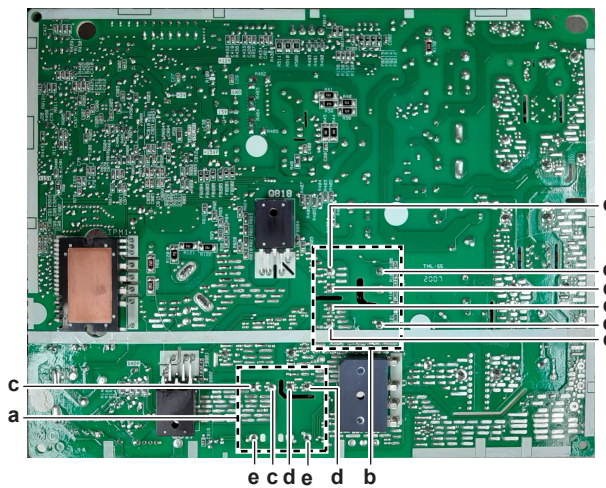

- a L803
- b L804
- c Measuring point
- d Measuring point
- e Measuring point

Is the resistance measurement correct?	Action
Yes	Proceed with the next step.
No	Replace the reactor, see " 4.16.2 Repair procedures " [▶ 179].

- 4 Measure the inductance of the reactor using an LCR meter.

Result: The inductance MUST be as follows:

Measuring points	Resistance
c-d	88.5~101.5 μ H

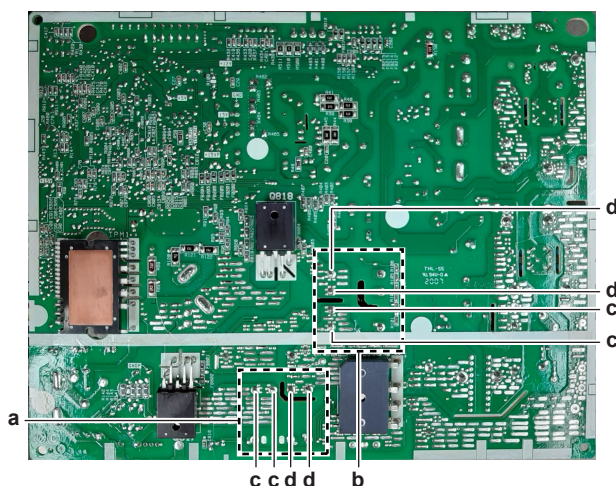

- a L803
- b L804
- c Measuring point
- d Measuring point

Is the inductance measurement correct?	Action
Yes	Return to the troubleshooting of the specific error and continue with the next step.
No	Replace the reactor, see "4.16.2 Repair procedures" [▶ 179].

4.16.2 Repair procedures

As the reactors are part of the main PCB, replace the complete main PCB. See ["4.12 Main PCB"](#) [▶ 129].

4.17 Streamer unit

4.17.1 Checking procedures

- 1 As there is no specific check procedure for this component, first perform a check of the indoor unit main PCB to check if the streamer unit needs to be replaced. See ["4.9.1 Checking procedures"](#) [▶ 110].

After complete check of the indoor unit main PCB, is the problem solved?	Action
Yes	No further actions required.
No	Replace the streamer unit, see "4.17.2 Repair procedures" [▶ 180].

4.17.2 Repair procedures

To remove the streamer unit

Prerequisite: Stop the unit operation via the user interface.

Prerequisite: Turn OFF the respective circuit breaker.

Prerequisite: Remove the required plate work, see "[4.14 Plate work](#)" [[▶ 157](#)].

- 1 Disconnect the connector from the streamer unit.

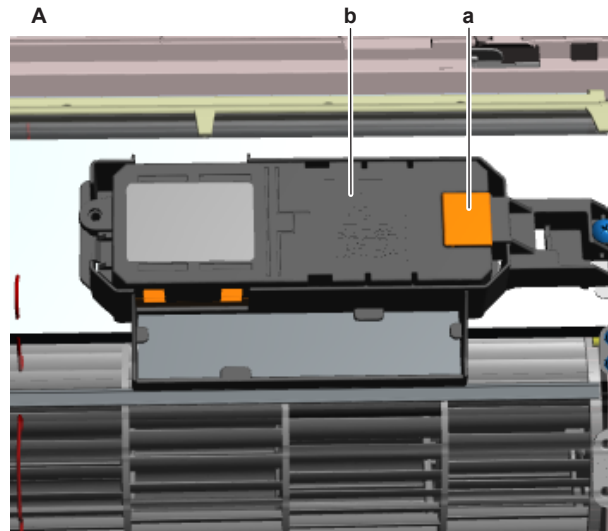

A Wall mounted indoor unit
a Streamer unit connector
b Streamer unit

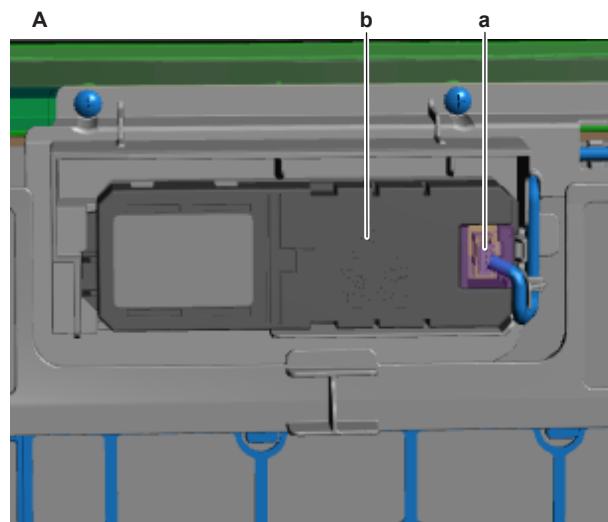

A Floor standing indoor unit
a Streamer unit connector
b Streamer unit

- 2 Click the streamer unit out of the indoor unit.
- 3 To install the streamer unit, see "[4.17.2 Repair procedures](#)" [[▶ 180](#)].

To install the streamer unit

- 1 Install the streamer unit in the correct location on the indoor unit.

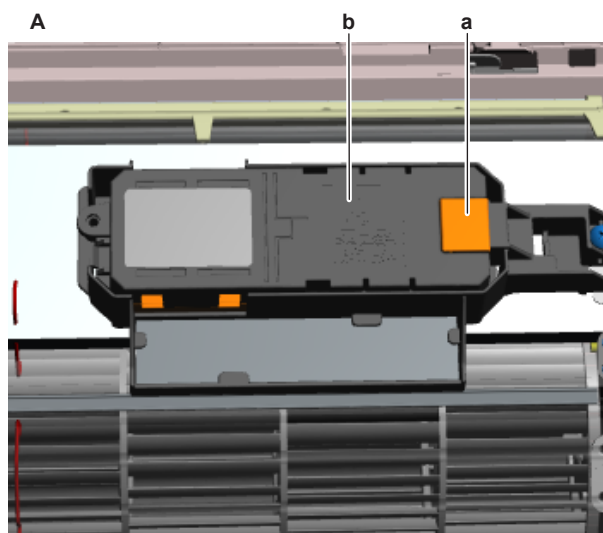

A Wall mounted indoor unit
a Streamer unit connector
b Streamer unit

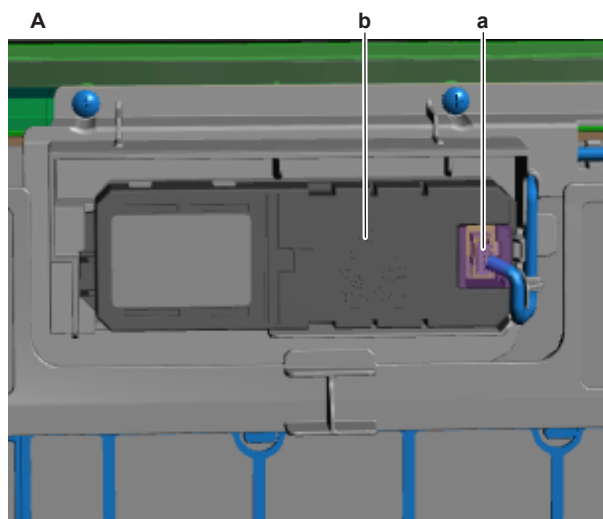

A Floor standing indoor unit
a Streamer unit connector
b Streamer unit

2 Connect the streamer unit harness to the streamer unit.

Is the problem solved?	Action
Yes	No further actions required.
No	Return to the troubleshooting of the specific error and continue with the next procedure.

4.18 Swing flap motor

4.18.1 Wall mounted indoor units - Class 20~42

Checking procedures

To perform an electrical check of the swing flap motor

Prerequisite: Stop the unit operation via the user interface.

Prerequisite: Turn OFF the respective circuit breaker.

Prerequisite: Remove the required plate work, see ["4.14 Plate work"](#) [▶ 157].

- 1 Disconnect the swing flap motor connector from the indoor unit main PCB.
- 2 Measure the resistance between the following pins of the motor connector.

Result: The measurements MUST be as shown in the table below.

Pins	Measured resistance (Ω)
5-1	232.5~267.5
5-2	
5-3	
5-4	
1-2	465~535
1-3	
1-4	
2-3	
2-4	
3-4	
Swing flap motor resistance measurements are correct?	Action
Yes	Return to the troubleshooting of the specific error and continue with the next procedure.
No	Replace the swing flap motor, see "Repair procedures" [▶ 182].

Repair procedures

To remove the swing flap motor

Prerequisite: Stop the unit operation via the user interface.

Prerequisite: Turn OFF the respective circuit breaker.

Prerequisite: Remove the required plate work, see ["4.14 Plate work"](#) [▶ 157].

- 1 Remove the switch box, see ["4.14 Plate work"](#) [▶ 157].
- 2 As the swing flap motor wiring harness is also connected to the swing raster motor, remove the swing raster motor, see ["4.19.2 Repair procedures"](#) [▶ 192].
- 3 Remove the swing flap from the indoor unit (by clicking it out).
- 4 Remove the screw that fixes the swing flap motor.

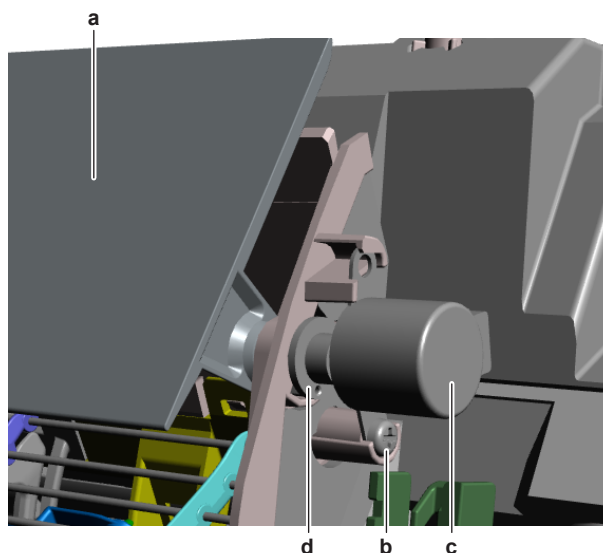

- a Swing flap
- b Screw (swing flap motor fixation)
- c Swing flap motor
- d Coupling piece

- 5 Remove the swing flap motor from the coupling piece.
- 6 To install the swing flap motor, see ["Repair procedures"](#) [▶ 182].

To install the swing flap motor

- 1 Install the coupling piece on the swing flap motor.
- 2 Install the swing flap motor in the correct location on the indoor unit.

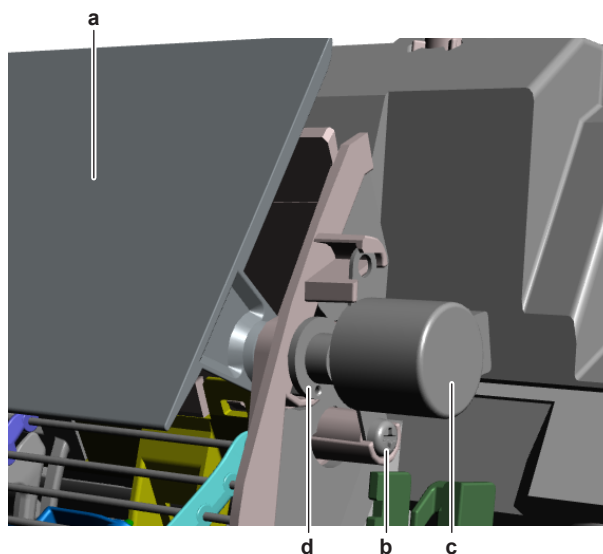

- a Swing flap
- b Screw (swing flap motor fixation)
- c Swing flap motor
- d Coupling piece

- 3 Install and tighten the screw to fix the swing flap motor.
- 4 Install the swing flap.
- 5 Install the swing raster motor, see ["4.19.2 Repair procedures"](#) [▶ 192].
- 6 Install the switch box, see ["4.14 Plate work"](#) [▶ 157].

Is the problem solved?	Action
Yes	No further actions required.

Is the problem solved?	Action
No	Return to the troubleshooting of the specific error and continue with the next procedure.

4.18.2 Wall mounted indoor units - Class 50~71

Checking procedures**To perform an electrical check of the swing flap motor**

Prerequisite: Stop the unit operation via the user interface.

Prerequisite: Turn OFF the respective circuit breaker.

Prerequisite: Remove the required plate work, see "[4.14 Plate work](#)" [[▶ 157](#)].

- 1 Disconnect the swing flap motor connector from the indoor unit main PCB.
- 2 Measure the resistance between the following pins of the motor connector.

Result: The measurements MUST be as shown in the table below.

Pins	Measured resistance (Ω)
5-1	353.4~406.6
5-2	
5-3	
5-4	
4-1	653.6~866.4
4-2	
4-3	
3-1	
3-2	
2-1	

Swing flap motor resistance measurements are correct?	Action
Yes	Return to the troubleshooting of the specific error and continue with the next procedure.
No	Continue with the next step.

- 3 Remove the swing flap motor, see "[Repair procedures](#)" [[▶ 185](#)].
- 4 Measure the resistance between the following pins of the connector on the swing flap motor.

Result: The measurements MUST be as shown in the table below.

Pins	Measured resistance (Ω)
1-2	353.4~406.6
1-3	
1-4	
1-5	

Pins	Measured resistance (Ω)
2-3	653.6~866.4
2-4	
2-5	
3-4	
3-5	
4-5	
Swing flap motor resistance measurements are correct?	Action
Yes	Replace the swing flap motor wiring harness, see " Repair procedures " [▶ 185].
No	Replace the swing flap motor, see " Repair procedures " [▶ 185].

Repair procedures

To remove the swing flap motor

Prerequisite: Stop the unit operation via the user interface.

Prerequisite: Turn OFF the respective circuit breaker.

Prerequisite: Remove the required plate work, see "[4.14 Plate work](#)" [▶ 157].

- 1 Remove the switch box, see "[4.14 Plate work](#)" [▶ 157].
- 2 Remove the main swing flap from the indoor unit (by clicking it out).
- 3 Remove the secondary swing flap from the indoor unit (by clicking it out).
- 4 Remove the screw from the swing flap motor.

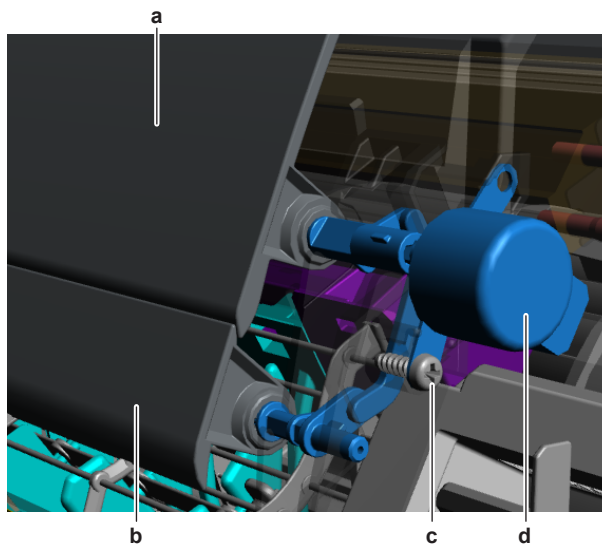

- a Main swing flap
- b Secondary swing flap
- c Screw (swing flap motor fixation)
- d Swing flap motor

- 5 Remove (pull back) the swing flap motor from the indoor unit.
- 6 Disconnect the wiring harness from the swing flap motor.
- 7 To install the swing flap motor, see "[Repair procedures](#)" [▶ 185].

To install the swing flap motor

- 1 Connect the wiring harness to the swing flap motor.
- 2 Install the swing flap motor on the correct location on the indoor unit. Make sure the swing flap motor shaft is correctly inserted in the link.

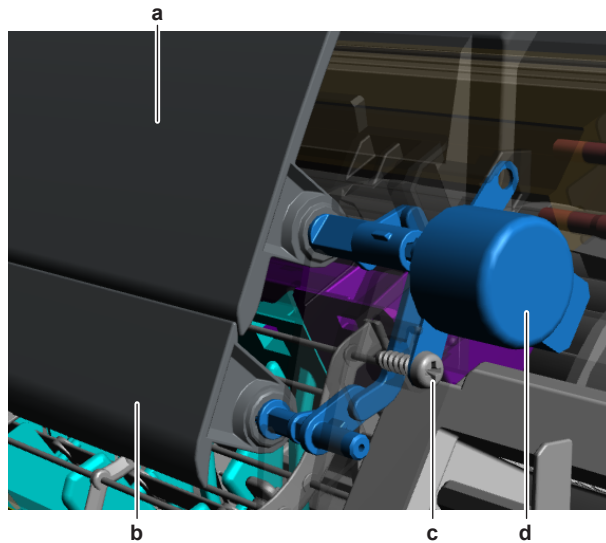

- a Main swing flap
- b Secondary swing flap
- c Screw (swing flap motor fixation)
- d Swing flap motor

- 3 Install and tighten the screw to fix the swing flap motor.
- 4 Install the secondary swing flap in the indoor unit (by clicking it on).
- 5 Install the main swing flap in the indoor unit (by clicking it on).
- 6 Install the switch box, see "4.14 Plate work" [▶ 157].

Is the problem solved?	Action
Yes	No further actions required.
No	Return to the troubleshooting of the specific error and continue with the next procedure.

To remove the swing flap motor wiring harness

Prerequisite: Stop the unit operation via the user interface.

Prerequisite: Turn OFF the respective circuit breaker.

Prerequisite: Remove the required plate work, see "4.14 Plate work" [▶ 157].

- 1 Remove the swing flap motor, see "Repair procedures" [▶ 185].



INFORMATION

The swing flap motor wiring harness is also connected to the swing raster motor.

- 2 Put a small drain pan (or container) under the drain hose.
- 3 Remove the screw from the fixation bracket and pull the drain hose downwards to remove it from the indoor unit.

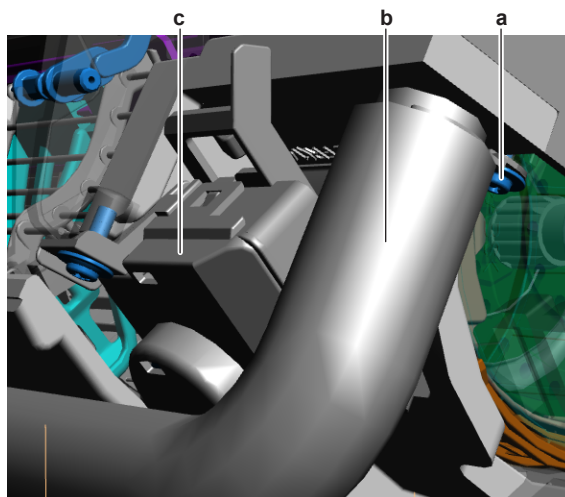

- a Screw (drain hose)
- b Drain hose
- c Swing raster motor cover

- 4 Remove the swing raster motor cover.
- 5 Disconnect the wiring harness from the swing raster motor.
- 6 Remove the swing flap motor wiring harness.
- 7 To install the swing flap motor wiring harness, see ["Repair procedures"](#) [▶ 185].

To install the swing flap motor wiring harness

- 1 Connect the wiring harness connector to the swing raster motor.
- 2 Install the swing raster motor cover.

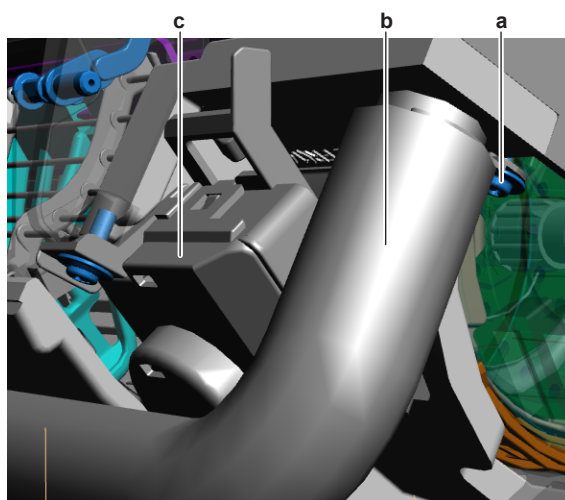

- a Screw (drain hose)
- b Drain hose
- c Swing raster motor cover

- 3 Install the drain hose on the indoor unit.
- 4 Install the drain hose fixation bracket. Install and tighten the screw.
- 5 Install the swing flap motor, see ["Repair procedures"](#) [▶ 185].

Is the problem solved?	Action
Yes	No further actions required.
No	Return to the troubleshooting of the specific error and continue with the next procedure.

4.18.3 Floor standing indoor units

Checking procedures**To perform an electrical check of the swing flap motor**

Prerequisite: Stop the unit operation via the user interface.

Prerequisite: Turn OFF the respective circuit breaker.

Prerequisite: Remove the required plate work, see "4.14 Plate work" [▶ 157].

- 1 Disconnect the swing flap motor connector from the indoor unit main PCB.
- 2 Measure the resistance between the following pins of the motor connector.

Result: The measurements MUST be as shown in the table below.

Pins	Measured resistance (Ω)
1-2	353.4~406.6
1-3	
1-4	
1-5	
2-3	706.8~813.2
2-4	
2-5	
2-4	
3-5	
4-5	

Swing flap motor resistance measurements are correct?	Action
Yes	Return to the troubleshooting of the specific error and continue with the next procedure.
No	Continue with the next step.

- 3 Remove the swing flap motor, see "Repair procedures" [▶ 189].
- 4 Measure the resistance between the following pins of the connector on the swing flap motor.

Result: The measurements MUST be as shown in the table below.

Pins	Measured resistance (Ω)
1-2	353.4~406.6
1-3	
1-4	
1-5	

Pins	Measured resistance (Ω)
2-3	706.8~813.2
2-4	
2-5	
3-4	
3-5	
4-5	
Swing flap motor resistance measurements are correct?	Action
Yes	Replace the swing flap motor wiring harness, see " Repair procedures " [▶ 189].
No	Replace the swing flap motor, see " Repair procedures " [▶ 189].

Repair procedures

To remove the swing flap motor

Prerequisite: Stop the unit operation via the user interface.

Prerequisite: Turn OFF the respective circuit breaker.

Prerequisite: Remove the required plate work, see "[4.14 Plate work](#)" [▶ 157].

- 1 Remove the switch box, see "[4.14 Plate work](#)" [▶ 157].
- 2 Remove the swing flap from the indoor unit (by clicking it out).
- 3 Remove the 2 screws that fix the swing flap motor.

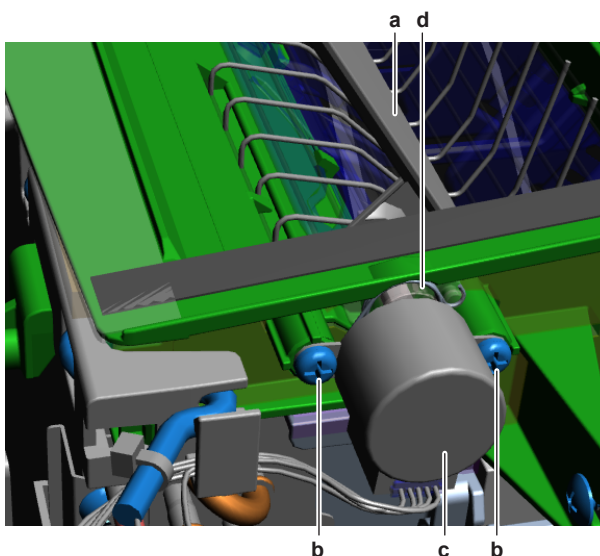

- a Swing flap
- b Screw (swing flap motor fixation)
- c Swing flap motor
- d Coupling piece

- 4 Remove the swing flap motor and coupling piece.
- 5 Remove the spring and remove the coupling piece from the swing flap motor.
- 6 Disconnect the wiring harness from the swing flap motor.
- 7 To install the swing flap motor, see "[Repair procedures](#)" [▶ 189].

To install the swing flap motor

- 1 Install the coupling piece on the swing flap motor. Install the spring to fix the coupling piece.
- 2 Connect the wiring harness to the swing flap motor.
- 3 Install the swing flap motor in the correct location on the indoor unit.

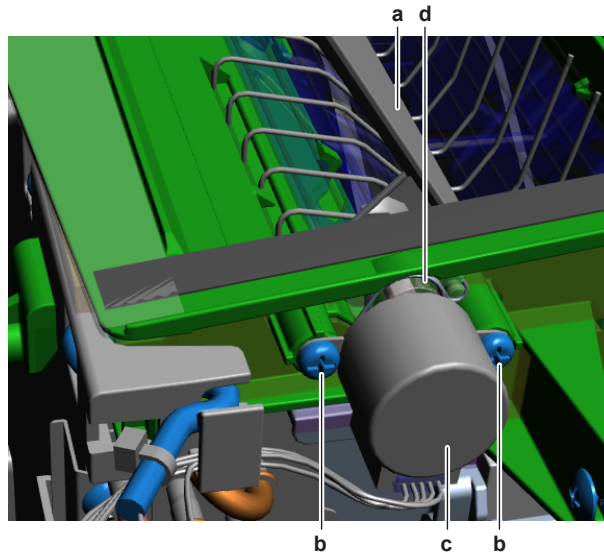

- a Swing flap
- b Screw (swing flap motor fixation)
- c Swing flap motor
- d Coupling piece

- 4 Install and tighten the 2 screws to fix the swing flap motor.
- 5 Install the swing flap.
- 6 Install the switch box, see ["4.14 Plate work"](#) [▶ 157].

Is the problem solved?	Action
Yes	No further actions required.
No	Return to the troubleshooting of the specific error and continue with the next procedure.

To remove the swing flap motor wiring harness

Prerequisite: Stop the unit operation via the user interface.

Prerequisite: Turn OFF the respective circuit breaker.

Prerequisite: Remove the required plate work, see ["4.14 Plate work"](#) [▶ 157].

- 1 Remove the switch box, see ["4.14 Plate work"](#) [▶ 157].
- 2 Disconnect the wiring harness from the swing flap motor.
- 3 Remove the swing flap motor wiring harness from the indoor unit.
- 4 To install the swing flap motor wiring harness, see ["Repair procedures"](#) [▶ 189].

To install the swing flap motor wiring harness

- 1 Connect the wiring harness connector to the swing flap motor.
- 2 Install the switch box, see ["4.14 Plate work"](#) [▶ 157].

Is the problem solved?	Action
Yes	No further actions required.

Is the problem solved?	Action
No	Return to the troubleshooting of the specific error and continue with the next procedure.

4.19 Swing raster motor

4.19.1 Checking procedures

To perform an electrical check of the swing raster motor

Prerequisite: Stop the unit operation via the user interface.

Prerequisite: Turn OFF the respective circuit breaker.

Prerequisite: Remove the required plate work, see "[4.14 Plate work](#)" [[▶ 157](#)].

- 1 Disconnect the swing raster motor connector from the indoor unit main PCB.
- 2 Measure the resistance between the following pins of the motor connector.

Result: The measurements MUST be as shown in the table below.

Pins	Measured resistance (Ω)
15-14	353.4~406.6
15-13	
15-12	
15-11	
14-13	706.8~813.2
14-12	
14-11	
13-12	
13-11	
12-11	

Swing raster motor resistance measurements are correct?	Action
Yes	Return to the troubleshooting of the specific error and continue with the next procedure.
No	Continue with the next step.

- 3 Remove the swing raster motor, see "[4.19.2 Repair procedures](#)" [[▶ 192](#)].
- 4 Measure the resistance between the following pins of the connector on the swing raster motor.

Result: The measurements MUST be as shown in the table below.

Pins	Measured resistance (Ω)	
1-2	353.4~406.6	
1-3		
1-4		
1-5		
2-3		706.8~813.2
2-4		
2-5		
3-4		
3-5		
4-5		
Swing raster motor resistance measurements are correct?	Action	
Yes	Replace the swing raster motor wiring harness, see " 4.19.2 Repair procedures " [▶ 192].	
No	Replace the swing raster motor, see " 4.19.2 Repair procedures " [▶ 192].	

4.19.2 Repair procedures

To remove the swing raster motor

Class 20~42 indoor unit

Prerequisite: Stop the unit operation via the user interface.

Prerequisite: Turn OFF the respective circuit breaker.

Prerequisite: Remove the required plate work, see "[4.14 Plate work](#)" [▶ 157].

- 1 Remove the switch box, see "[4.14 Plate work](#)" [▶ 157].
- 2 Put a small drain pan (or container) under the drain hose.
- 3 Remove the screw from the fixation bracket and pull the drain hose downwards to remove it from the indoor unit.

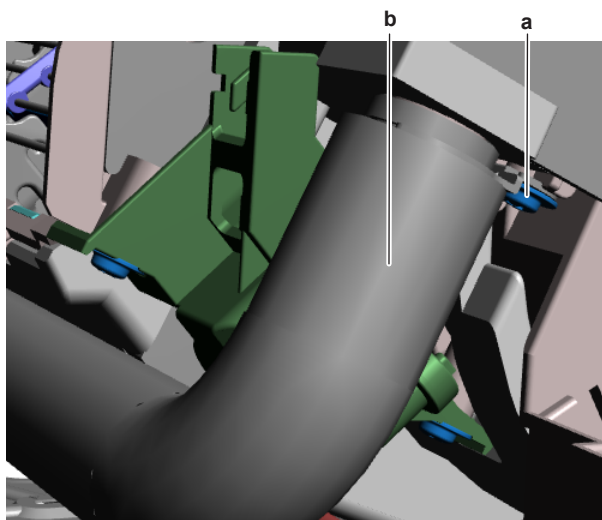

- a Screw (drain hose)
- b Drain hose

- 4 Remove the 2 screws that fix the swing raster motor assembly to the indoor unit.

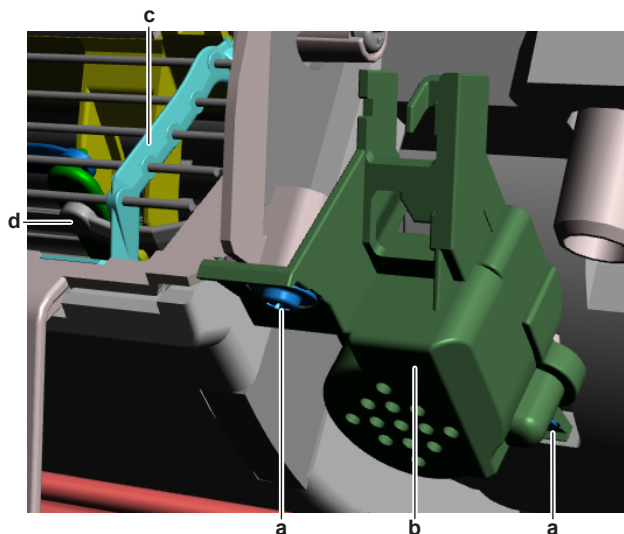

- a Screw (swing raster motor assembly)
- b Swing raster motor assembly
- c Fan guard
- d Swing raster motor rod

- 5 Remove the fan guard.
- 6 Disconnect the swing raster motor rod from the swing raster shaft.
- 7 Remove the swing raster motor assembly from the indoor unit.
- 8 Disconnect the rod and link from the swing raster motor. Keep the rod and link for reuse.

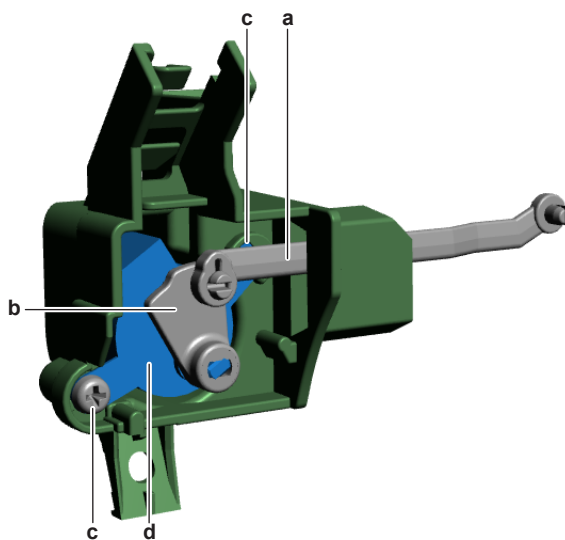

- a Rod
- b Link
- c Screw (swing raster motor fixation)
- d Swing raster motor

- 9 Remove the 2 screws that fix the swing raster motor to the bracket.
- 10 Remove the swing raster motor.
- 11 Disconnect the wiring harness from the swing raster motor.
- 12 To install the swing raster motor, see "[4.19.2 Repair procedures](#)" [▶ 192].

Class 50~71 indoor unit

Prerequisite: Stop the unit operation via the user interface.

Prerequisite: Turn OFF the respective circuit breaker.

Prerequisite: Remove the required plate work, see "4.14 Plate work" [▶ 157].

- 1 Remove the switch box, see "4.14 Plate work" [▶ 157].
- 2 Put a small drain pan (or container) under the drain hose.
- 3 Remove the screw from the fixation bracket and pull the drain hose downwards to remove it from the indoor unit.

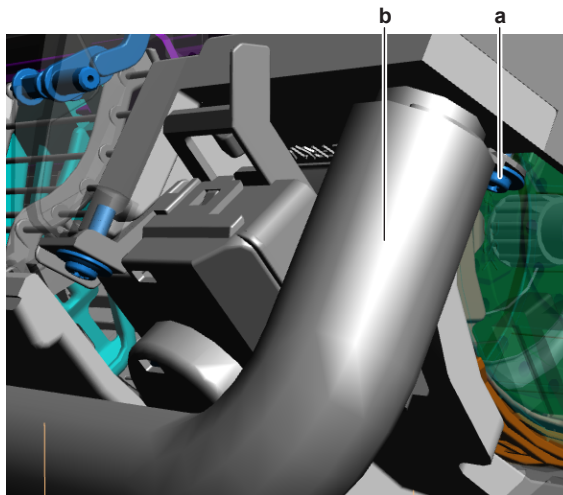

a Screw (drain hose)
b Drain hose

- 4 Remove the swing raster motor cover.

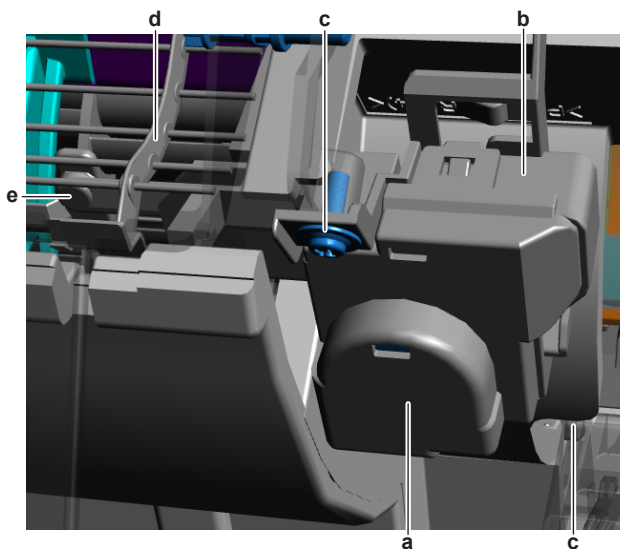

a Swing raster motor cover
b Swing raster motor assembly
c Screw (swing raster motor assembly)
d Fan guard
e Swing raster motor rod

- 5 Remove the 2 screws that fix the swing raster motor assembly to the indoor unit.
- 6 Disconnect the swing raster motor rod from the swing raster shaft.
- 7 Remove the swing raster motor assembly from the indoor unit.
- 8 Remove the 2 screws that fix the swing raster motor to the bracket.

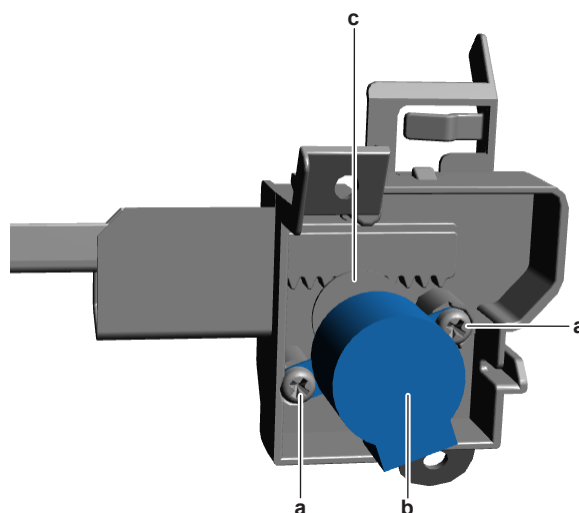

- a Screw (swing raster motor fixation)
- b Swing raster motor
- c Gear

- 9 Remove the swing raster motor from the gear.
- 10 Disconnect the wiring harness from the swing raster motor.
- 11 To install the swing raster motor, see "[4.19.2 Repair procedures](#)" [▶ 192].

To install the swing raster motor

Class 20~42 indoor unit

- 1 Connect the wiring harness to the swing raster motor.
- 2 Install the swing raster motor on the correct location on the bracket.

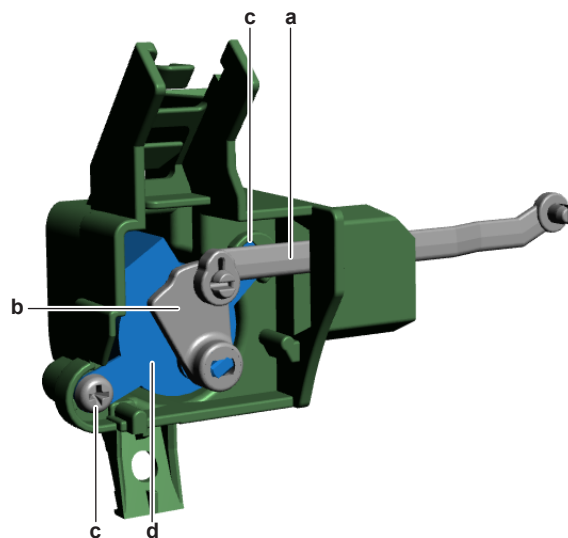

- a Rod
- b Link
- c Screw (swing raster motor fixation)
- d Swing raster motor

- 3 Install and tighten the 2 screws to fix the swing raster motor to the bracket.
- 4 Guide the rod and link inside the bracket to the correct location.
- 5 Connect the rod and link to the swing raster motor.
- 6 Install the swing raster motor assembly on the correct location on the indoor unit while guiding the rod inside the swing raster compartment.

- 7 Install the 2 screws to fix the swing raster motor assembly. Do NOT yet tighten the screws.

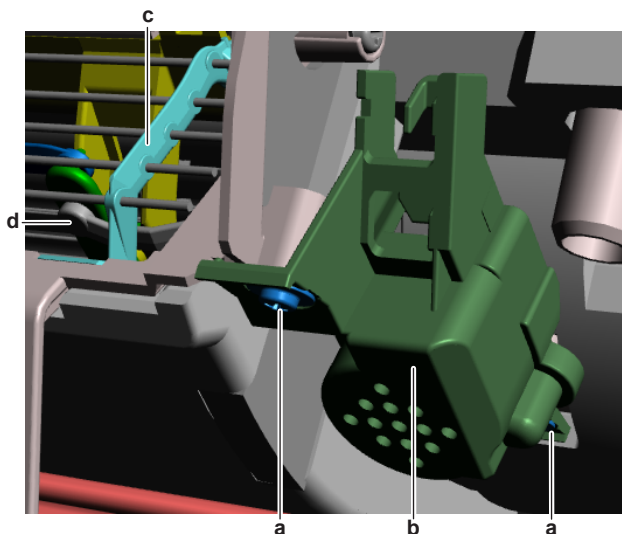

- a Screw (swing raster motor assembly)
- b Swing raster motor assembly
- c Fan guard
- d Swing raster motor rod

- 8 Connect the swing raster motor rod to the swing raster shaft using soft tools.
- 9 Tighten the 2 screws to properly fix the swing raster motor assembly.
- 10 Install the fan guard.
- 11 Connect the drain hose to the indoor unit.

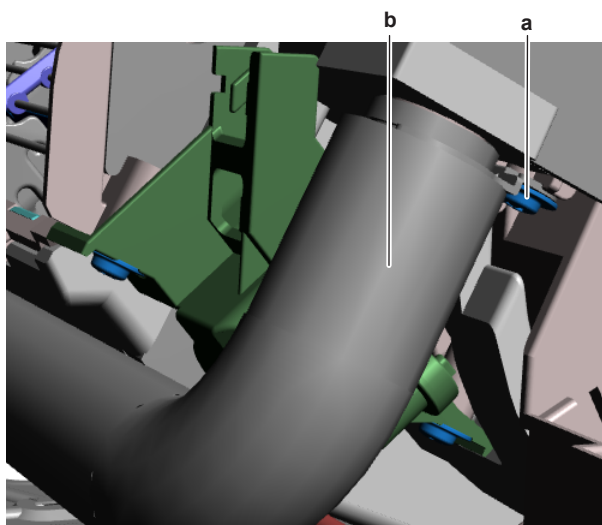

- a Screw (drain hose)
- b Drain hose

- 12 Install the drain hose fixation bracket. Install and tighten the screw.
- 13 Install the switch box, see "4.14 Plate work" [▶ 157].

Is the problem solved?	Action
Yes	No further actions required.
No	Return to the troubleshooting of the specific error and continue with the next procedure.

Class 50~71 indoor unit

- 1 Connect the wiring harness to the swing raster motor.
- 2 Install the gear on the swing raster motor shaft.
- 3 Install the swing raster motor (and gear) on the correct location on the bracket.

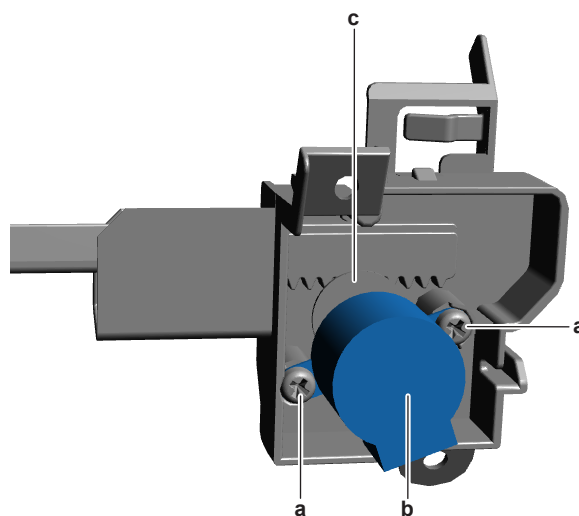

- a Screw (swing raster motor fixation)
- b Swing raster motor
- c Gear

- 4 Guide the rod inside the bracket to the correct location. Make sure that the teeth of the rod are properly fitted on the gear.
- 5 Install and tighten the 2 screws to fix the swing raster motor to the bracket.
- 6 Install the swing raster motor assembly on the correct location on the indoor unit while guiding the rod inside the swing raster compartment.
- 7 Install the 2 screws to fix the swing raster motor assembly. Do NOT yet tighten the screws.

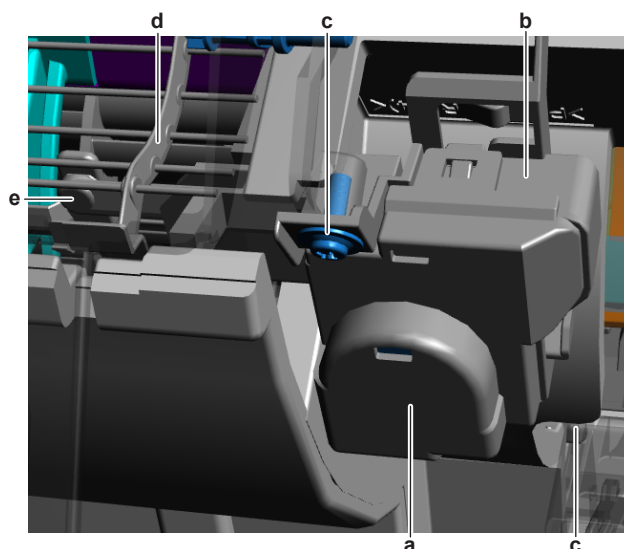

- a Swing raster motor cover
- b Swing raster motor assembly
- c Screw (swing raster motor assembly)
- d Fan guard
- e Swing raster motor rod

- 8 Connect the swing raster motor rod to the swing raster shaft using soft tools.
- 9 Tighten the 2 screws to properly fix the swing raster motor assembly.

- 10 Install the fan guard.
- 11 Install the swing raster motor cover.
- 12 Connect the drain hose to the indoor unit.

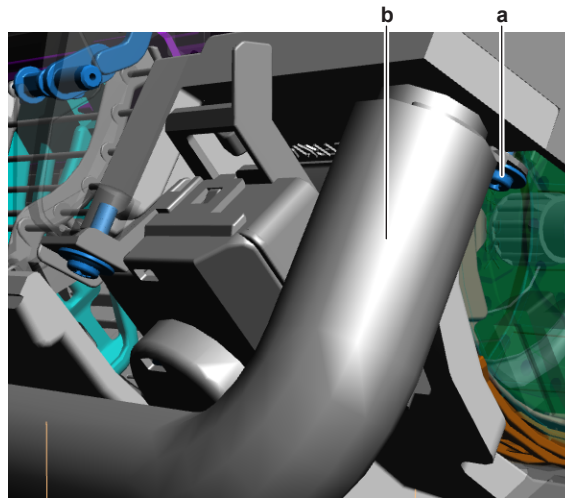

a Screw (drain hose)
b Drain hose

- 13 Install the drain hose fixation bracket. Install and tighten the screw.
- 14 Install the switch box, see "4.14 Plate work" [▶ 157].

Is the problem solved?	Action
Yes	No further actions required.
No	Return to the troubleshooting of the specific error and continue with the next procedure.

To remove the swing raster motor wiring harness

For Class 20~42 indoor units: As the swing raster motor wiring harness is part of the swing flap motor, remove the swing flap motor, see "Repair procedures" [▶ 182].

For Class 50~71 indoor units: As the swing raster motor wiring harness is the same harness as the swing flap motor wiring harness, remove the swing flap motor wiring harness, see "Repair procedures" [▶ 185].

- 1 To install the swing raster motor wiring harness, see "4.19.2 Repair procedures" [▶ 192].

To install the swing raster motor wiring harness

For Class 20~42 indoor units: As the swing raster motor wiring harness is part of the swing flap motor, install the swing flap motor, see "Repair procedures" [▶ 182].

For Class 50~71 indoor units: As the swing raster motor wiring harness is the same harness as the swing flap motor wiring harness, install the swing flap motor wiring harness, see "Repair procedures" [▶ 185].

Is the problem solved?	Action
Yes	No further actions required.
No	Return to the troubleshooting of the specific error and continue with the next procedure.

4.20 Thermistors

4.20.1 Checking procedures



INFORMATION

It is recommended to perform the checks in the listed order.

To perform a mechanical check of the specific thermistor

Prerequisite: Stop the unit operation via the user interface.

Prerequisite: Turn OFF the respective circuit breaker.

Prerequisite: Remove the required plate work, see ["4.14 Plate work"](#) [▶ 157].

- 1 Locate the thermistor and remove the insulation if needed. Check that the thermistor is correctly installed and that there is thermal contact between the thermistor and the piping or ambient (for air thermistor).

Is the thermistor correctly installed (thermal contact between the thermistor and the piping)?	Action
Yes	Perform an electrical check of the specific thermistor, see "4.20.1 Checking procedures" [▶ 199].
No	Correctly install the thermistor, see "4.20.2 Repair procedures" [▶ 203].

To perform an electrical check of the specific thermistor

- 1 First perform a mechanical check of the thermistor, see ["4.20.1 Checking procedures"](#) [▶ 199].
- 2 Locate the thermistor.



INFORMATION

Remove the thermistor from its holder if not reachable with a contact thermometer.

- 3 Measure the temperature using a contact thermometer.

Outdoor units

Name	Symbol	Location (PCB)	Connector (pins)	Inter-mediate connector (pins)	Reference (table)
Air thermistor	R1T	Main (O/U)	S90:1-2	-	A
Heat exchanger thermistor	R2T	Main (O/U)	S90:3-4	-	A
Discharge pipe thermistor	R3T	Main (O/U)	S90:5-6	-	A

Wall mounted indoor units

Name	Symbol	Location (PCB)	Connector (pins)	Intermediate connector (pins)	Reference (table)
Indoor unit air (room) thermistor	R1T	Display PCB A3P on main PCB (I/U)	S800:5-11	S27:1-2 on display PCB	B
Heat exchanger thermistor	R2T	Main (I/U)	S501:1-2	-	A

Floor standing indoor units

Name	Symbol	Location (PCB)	Connector (pins)	Intermediate connector (pins)	Reference (table)
Heat exchanger thermistor	R1T	Main (I/U)	S501:1-2	-	A
Indoor unit air (room) thermistor	R2T	Main (I/U)	S501:3-4	-	A
Humidity thermistor	R3T	Humidity sensor PCB A5P on main PCB (I/U)	S600	CN on A5P	-

- 4 Determine the thermistor resistance that matches the measured temperature.

Thermistor – Table A

T °C	kΩ	T °C	kΩ	T °C	kΩ	T °C	kΩ
-20	197.81	10	39.96	40	10.63	70	3.44
-19	186.53	11	38.08	41	10.21	71	3.32
-18	175.97	12	36.30	42	9.81	72	3.21
-17	166.07	13	34.62	43	9.42	73	3.11
-16	156.80	14	33.02	44	9.06	74	3.01
-15	148.10	15	31.50	45	8.71	75	2.91
-14	139.94	16	30.06	46	8.37	76	2.82
-13	132.28	17	28.70	47	8.05	77	2.72
-12	125.09	18	27.41	48	7.75	78	2.64
-11	118.34	19	26.18	49	7.46	79	2.55
-10	111.99	20	25.01	50	7.18	80	2.47

T °C	kΩ	T °C	kΩ	T °C	kΩ	T °C	kΩ
-9	106.03	21	23.91	51	6.91		
-8	100.41	22	22.85	52	6.65		
-7	95.14	23	21.85	53	6.41		
-6	90.17	24	20.90	54	6.65		
-5	85.49	25	20.00	55	6.41		
-4	81.08	26	19.14	56	6.18		
-3	76.93	27	18.32	57	5.95		
-2	73.01	28	17.54	58	5.74		
-1	69.32	29	16.80	59	5.14		
0	65.84	30	16.10	60	4.87		
1	62.54	31	15.43	61	4.70		
2	59.43	32	14.79	62	4.54		
3	56.49	33	14.18	63	4.38		
4	53.71	34	13.59	64	4.23		
5	51.09	35	13.04	65	4.08		
6	48.61	36	12.51	66	3.94		
7	46.26	37	12.01	67	3.81		
8	44.05	38	11.52	68	3.68		
9	41.95	39	11.06	69	3.56		

Thermistor – Table B

T °C	kΩ	T °C	kΩ	T °C	kΩ	T °C	kΩ
-30	200.20	5	25.9	40	5.3	75	1.5
-25	144.32	10	20.2	45	4.3	80	1.3
-20	105.38	15	15.8	50	3.6	85	1.1
-15	77.90	20	12.5	55	3.0	90	0.9
-10	58.25	25	10.0	60	2.5	95	0.8
-5	44.0	30	8.0	65	2.1		
0	33.6	35	6.5	70	1.8		

- 5** Disconnect the thermistor connector from the appropriate PCB.
- 6** Measure the resistance between the appropriate pins of the thermistor connector.
- 7** Check that the measured resistance value matches the resistance determined through the measured temperature (earlier step in the procedure).

- E.g. R1T thermistor:
- Measured temperature with contact thermometer: 23.1°C,
- Resistance value determined through temperature (using the thermistor table A):
Resistance at 23°C: 21.85 kΩ,
Resistance at 24°C: 20.90 kΩ,
- Disconnect connector and measure resistance between S90 pin 1-2:
Measured resistance: 21.80 kΩ,
- Measured resistance value is inside the range. R1T thermistor passes the check.

i **INFORMATION**
All thermistors have a resistance tolerance of 3%.

i **INFORMATION**
In most cases, the user interface allows to monitor the thermistors.
If the measured resistance value matches the resistance determined through the measured temperature, but the temperature for the corresponding thermistor is NOT correct on the user interface display, replace the applicable PCB.

i **INFORMATION**
See the overview of the thermistors at the start of the procedure and the "[7.2 Wiring diagram](#)" [▶ 235] to determine if the specific thermistor is either:

- Directly connected to the PCB
- Connected to an intermediate connector which is connected to the PCB

For thermistors directly connected to the PCB

Does the measured resistance of the thermistor match with the temperature determined resistance?	Action
Yes	Thermistor is OK. Return to the troubleshooting of the specific error and continue with the next procedure.
No	Replace the specific thermistor, see " 4.20.2 Repair procedures " [▶ 203].

For thermistors connected to an intermediate connector

Does the measured resistance of the thermistor match with the temperature determined resistance?	Action
Yes	Thermistor is OK. Return to the troubleshooting of the specific error and continue with the next procedure.
No	Continue with the next step.

- 8 Disconnect the thermistor from the intermediate connector and measure the resistance of the thermistor (between the appropriate pins of the connector).

Does the measured resistance of the thermistor match with the temperature determined resistance?	Action
Yes	Correct the wiring between the thermistor connector on the PCB and the intermediate connector, see "7.2 Wiring diagram" [▶ 235].
No	Replace the specific thermistor, see "4.20.2 Repair procedures" [▶ 203].

4.20.2 Repair procedures

To remove the thermistor

Indoor unit air (room) thermistor

WALL MOUNTED INDOOR UNITS

As the indoor unit air (room) thermistor is located on the display PCB, remove the display PCB as described in the steps below:

Prerequisite: Stop the unit operation via the user interface.

Prerequisite: Turn OFF the respective circuit breaker.

Prerequisite: Remove the required plate work, see ["4.14 Plate work"](#) [▶ 157].

- 1 Remove the display panel from the indoor unit.
- 2 Pull up the bottom of the indication lamp cover.

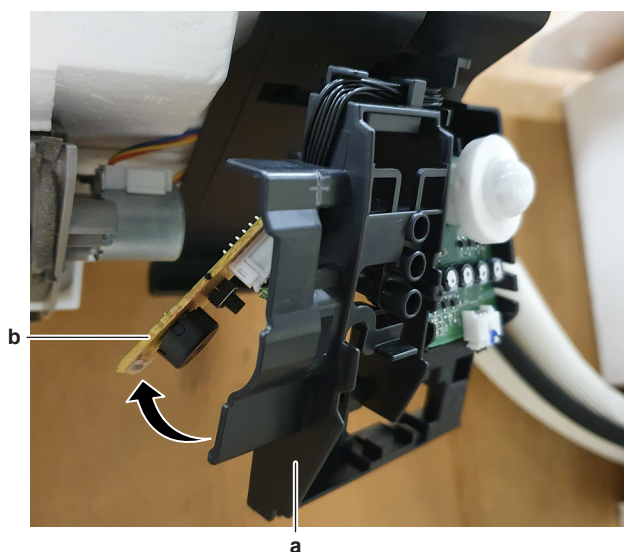

- a** Indication lamp cover
b Display PCB

- 3 Remove the display PCB from the back side of the indication lamp cover.
- 4 Disconnect the connector from the display PCB.
- 5 To install the indoor unit air (room) thermistor, see ["4.20.2 Repair procedures"](#) [▶ 203].

FLOOR STANDING INDOOR UNITS

- 6 Open the thermistor holder and remove the thermistor from the holder.

Other refrigerant side thermistors

Prerequisite: Stop the unit operation via the user interface.

Prerequisite: Turn OFF the respective circuit breaker.

Prerequisite: Remove the required plate work, see "4.14 Plate work" [▶ 157].

- 1 Locate the thermistor that needs to be removed.
- 2 Remove the thermistor as follows:
 - For outdoor unit air (ambient) thermistor:
Remove the thermistor from the heat exchanger grille recess.
Remove the protection tube.
 - For refrigerant piping thermistors:
 - Cut the tie straps that fix the insulation and the thermistor wire.
 - Cut and remove the insulation.
 - Pull the clip that fixes the thermistor.
 - Remove the thermistor from the thermistor holder.

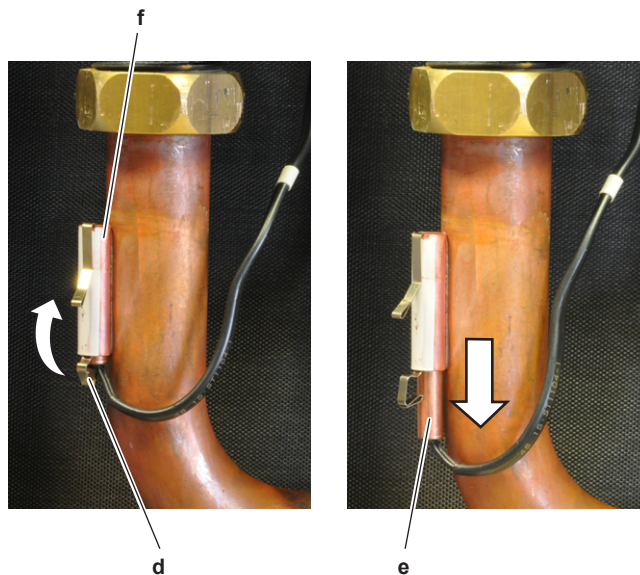
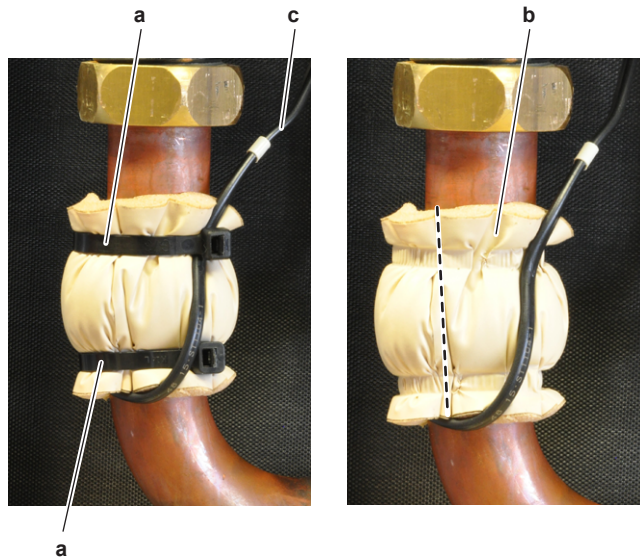

- a Tie strap
- b Insulation
- c Thermistor wire
- d Clip
- e Thermistor
- f Thermistor holder

- 3 Cut all tie straps that fix the thermistor harness.

- 4 Disconnect the thermistor connector from the appropriate PCB and remove the thermistor.



INFORMATION

Some of the thermistors are wired to the same connector. See connector and pin information of the thermistors at the start of the electrical check procedure and "[7.2 Wiring diagram](#)" [[▶ 235](#)]. ALWAYS replace the complete set of thermistors wired to the same connector.

- 5 When removing the complete set of thermistors wired to the same connector:
 - Remove all other thermistors wired to the connector from their thermistor holder,
 - Disconnect the thermistor connector,
 - Remove the complete set of thermistors.
- 6 To install the thermistor, see "[4.20.2 Repair procedures](#)" [[▶ 203](#)].

To install the thermistor

Indoor unit air (room) thermistor

WALL MOUNTED INDOOR UNITS

As the indoor unit air (room) thermistor is located on the display PCB, install the display PCB as described in the steps below:

- 1 Connect the connector to the display PCB.
- 2 Install the display PCB in the correct location on the back side of the indication lamp cover. Make sure to route the wiring harness through the harness retainers.

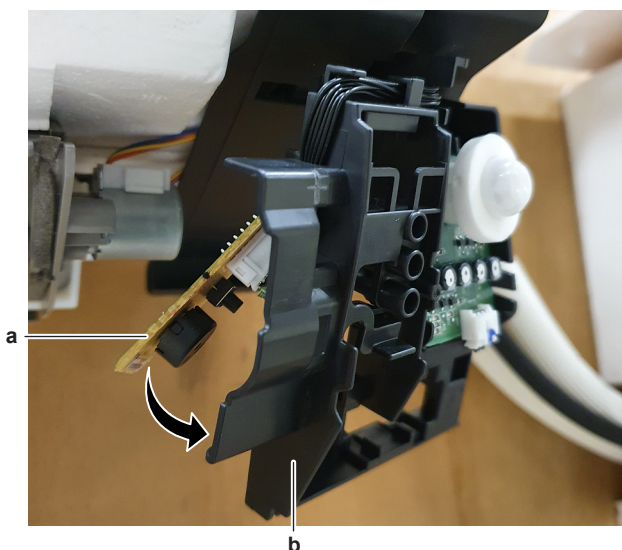

- a Display PCB
- b Indication lamp cover

- 3 Install the indication lamp cover in the correct location on the indoor unit.
- 4 Install the display panel.

FLOOR STANDING INDOOR UNITS

Procedure is similar as for the outdoor unit air thermistor, see below.

Other refrigerant side thermistors

- 1 Install the thermistor as follows:

- For outdoor unit air (ambient) thermistor:
Insert the thermistor in the protection tube.
Correctly install the thermistor in the heat exchanger grille recess.
- For refrigerant piping thermistors:
Pull the clip and install the thermistor in the specific thermistor holder. Make sure the clip is in the correct position (blocking the thermistor).

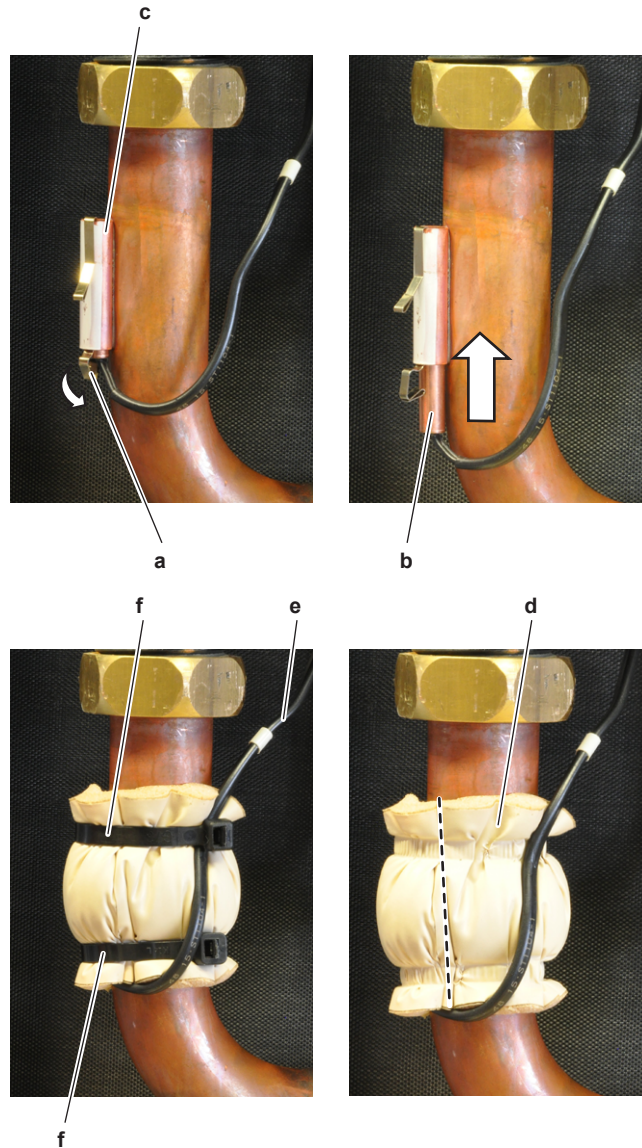

- a Clip
- b Thermistor
- c Thermistor holder
- d Insulation
- e Thermistor wire
- f Tie strap

- 2 Route the thermistor harness towards the appropriate PCB.
- 3 Connect the thermistor connector to the appropriate PCB.



INFORMATION

Some of the thermistors are wired to the same connector. See connector and pin information of the thermistors at the start of the electrical check procedure and "7.2 Wiring diagram" [▶ 235]. ALWAYS replace the complete set of thermistors wired to the same connector.

- 4 When installing the complete set of thermistors wired to the same connector:
 - Install all other thermistors wired to the connector in their thermistor holder,
 - Route the thermistor harness of all thermistors towards the appropriate PCB or intermediate connector,
 - Connect the thermistor connector.

**WARNING**

When reconnecting a connector to the PCB, make sure to connect it on the correct location and do NOT apply force, as this may damage the connector or connector pins of the PCB.

- 5 Fix the thermistor harness using new tie straps
- 6 Install the insulation around the thermistor.
- 7 Fix the insulation and the thermistor wire using new tie straps.

Is the problem solved?	Action
Yes	No further actions required.
No	Return to the troubleshooting of the specific error and continue with the next procedure.

4.21 Wifi control PCB

4.21.1 Checking procedures

To perform a power check of the wifi control PCB

Prerequisite: Stop the unit operation via the user interface.

Prerequisite: Turn OFF the respective circuit breaker.

- 1 Remove the required plate work, see "[4.14 Plate work](#)" [▶ 157].
- 2 Turn ON the power of the unit.
- 3 Measure the power supply voltage between the pins 4-5 on the wifi control PCB connector.

Result: The measured voltage MUST be 10~16 V DC.

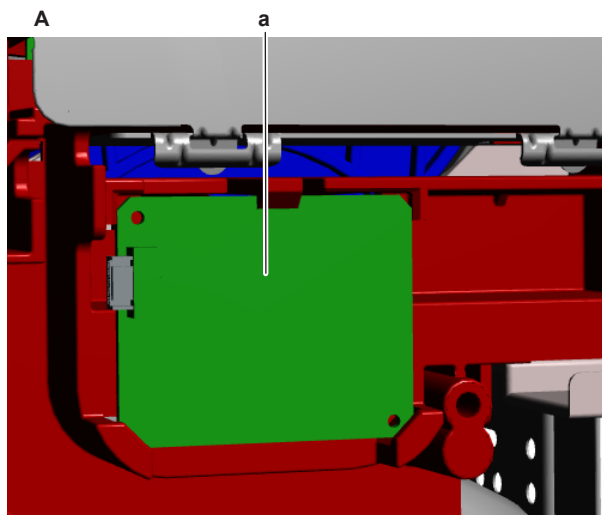

A Wall mounted indoor unit

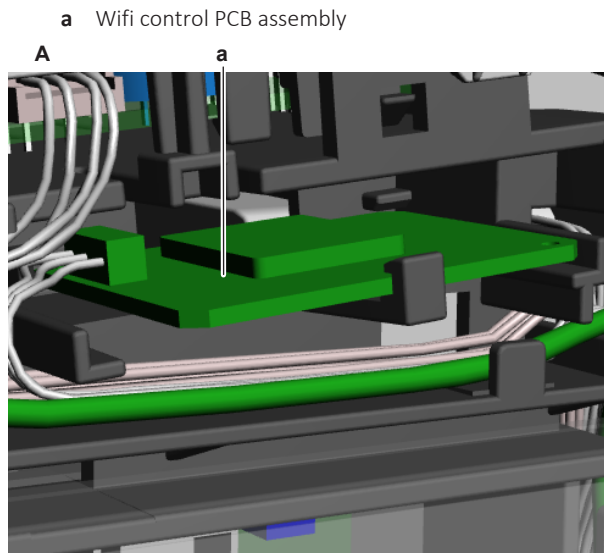

A Floor standing indoor unit
a Wifi control PCB assembly

Is the measured power supply voltage correct?	Action
Yes	Skip the next step..
No	Continue with the next step.

4 Measure the output voltage between between the pins 4-5 on the connector S801 on the indoor unit main PCB.

Result: The measured voltage MUST be 10~16 V DC.

Is the output voltage on the indoor unit main PCB correct?	Action
Yes	Replace the wifi control PCB wiring harness, see "4.21.2 Repair procedures" [▶ 208].
No	Perform a check of the indoor unit main PCB, see "4.9.1 Checking procedures" [▶ 110].

5 As there are no further check procedures for this component, perform a check of the indoor unit main PCB to check if the wifi control PCB needs to be replaced. See ["4.9.1 Checking procedures"](#) [▶ 110].

After complete check of the indoor unit main PCB, is the problem solved?	Action
Yes	No further actions required.
No	Replace the wifi control PCB, see "4.21.2 Repair procedures" [▶ 208].

4.21.2 Repair procedures

To remove the wifi control PCB

Prerequisite: Stop the unit operation via the user interface.

Prerequisite: Turn OFF the respective circuit breaker.

Prerequisite: Remove the required plate work, see ["4.14 Plate work"](#) [▶ 157].

- 1 Disconnect the connector from the wifi control PCB.
- 2 Carefully click the complete wifi control PCB assembly out of the indoor unit.

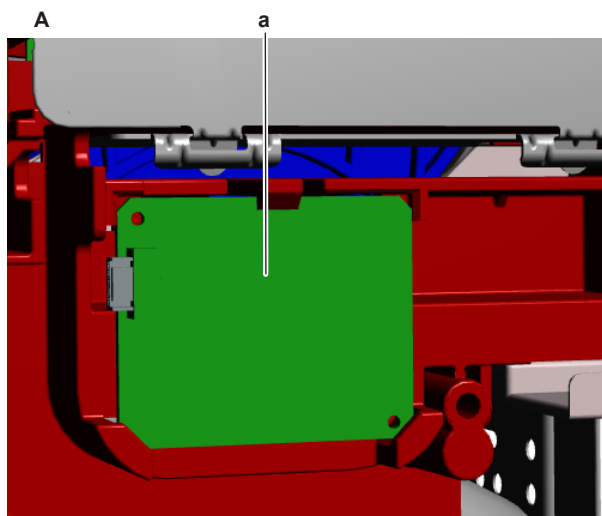

A Wall mounted indoor unit
a Wifi control PCB assembly

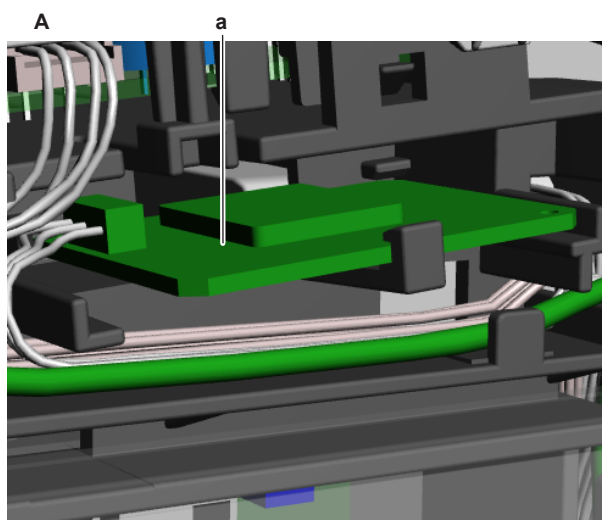

A Floor standing indoor unit
a Wifi control PCB assembly

- 3 To install the wifi control PCB assembly, see ["4.21.2 Repair procedures"](#) [▶ 208].

To install the wifi control PCB

- 1 Click the wifi control PCB assembly on the indoor unit.

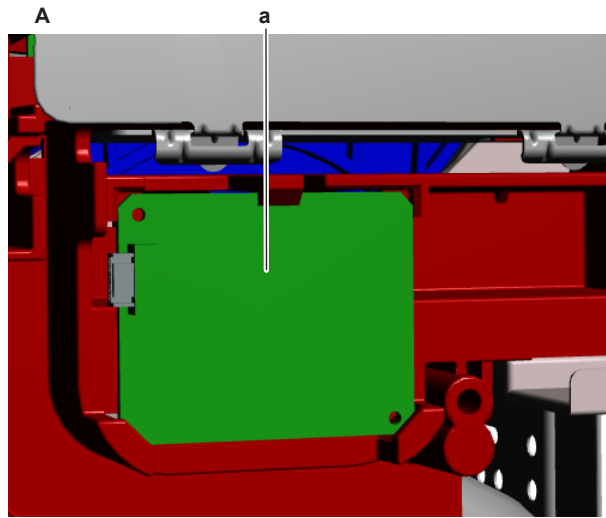

A Wall mounted indoor unit
a Wifi control PCB assembly

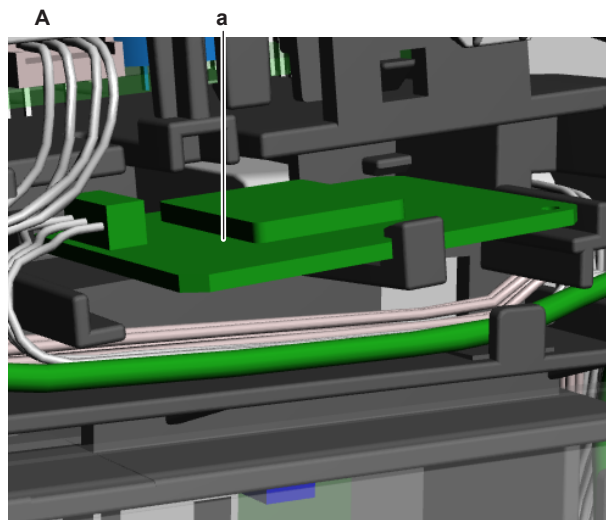

A Floor standing indoor unit
a Wifi control PCB assembly

2 Connect the harness to the wifi control PCB assembly.

Is the problem solved?	Action
Yes	No further actions required.
No	Return to the troubleshooting of the specific error and continue with the next procedure.

To remove the wifi control PCB wiring harness

Prerequisite: Stop the unit operation via the user interface.

Prerequisite: Turn OFF the respective circuit breaker.

Prerequisite: Remove the required plate work, see "4.14 Plate work" [▶ 157].

- 1 Disconnect the wiring harness from the wifi control PCB.
- 2 Disconnect the wiring harness connector from the indoor unit main PCB.
- 3 Cut all tie straps (if any) that fix the wiring harness.
- 4 Route the wiring harness out of the harness retainers and remove the wifi control PCB wiring harness.

- 5 To install the wifi control PCB wiring harness, see "[4.21.2 Repair procedures](#)" [▶ 208].

To install the wifi control PCB wiring harness

- 1 Connect the wiring harness connector to the indoor unit main PCB.



WARNING

When reconnecting a connector to the PCB, make sure to connect it on the correct location and do NOT apply force, as this may damage the connector or connector pins of the PCB.

- 2 Route the wiring harness through the appropriate harness retainers towards the wifi control PCB.
- 3 Connect the wiring harness to the wifi control PCB.
- 4 Fix the wiring harness using new tie straps (if needed).

Is the problem solved?	Action
Yes	No further actions required.
No	Return to the troubleshooting of the specific error and continue with the next procedure.

5 Third party components

5.1 Electrical circuit

5.1.1 Checking procedures

To check the power supply of the unit

Prerequisite: Stop the unit operation via the user interface.

Prerequisite: Turn OFF the respective circuit breaker.

Prerequisite: Remove the required plate work, see ["4.14 Plate work"](#) [▶ 157].

- 1 Check that the power supply cables and earth connection are firmly fixed to the power supply terminal X1M.
- 2 Measure the insulation resistance between each power supply terminal and the ground using a megger device of 500 V DC. All measurements MUST be >1MΩ. If insulation resistance is <1MΩ, earth leakage is present.
- 3 Turn ON the power of the unit.
- 4 Measure the voltage between L and N on the power supply terminal X1M.

Result: The voltage MUST be 230 V AC ± 10%.

- 5 Unbalance between the phases MUST NOT exceed 2%.

Is the measured voltage (power supply) correct?	Action
Yes	Return to the troubleshooting of the specific error and continue with the next procedure.
No	Adjust the power supply, see "5.1.2 Repair procedures" [▶ 213].

To check the power supply to the indoor unit

Prerequisite: Stop the unit operation via the user interface.

Prerequisite: Turn OFF the respective circuit breaker.

- 1 Remove the required plate work, see ["4.14 Plate work"](#) [▶ 157].
- 2 Check that the power supply cables and earth connection are firmly fixed to the indoor unit power supply terminal X1M.
- 3 Measure the insulation resistance between each power supply terminal and the ground using a megger device of 500 V DC. All measurements MUST be >1MΩ. If insulation resistance is <1MΩ, earth leakage is present.
- 4 Turn ON the power using the respective circuit breaker.
- 5 Measure the voltage between L and N on the indoor unit power supply terminal X1M.

Result: The voltage MUST be 230 V AC ± 10%.

Is the measured voltage (power supply) correct?	Action
Yes	Return to the troubleshooting of the specific error and continue with the next procedure.

Is the measured voltage (power supply) correct?	Action
No	Continue with the next step.

6 Check the power supply to the unit, see ["5.1.1 Checking procedures"](#) [▶ 212].

Does the unit receive power?	Action
Yes	Correct the wiring from the main power supply terminal to the indoor unit power supply terminal, see "5.1.2 Repair procedures" [▶ 213].
No	Adjust the power supply to the unit, see "5.1.2 Repair procedures" [▶ 213].

To check if the power supply is compliant with the regulations

- 1 Check that the power source is in line with the requirements described in the databook.

Is the power supply compliant with the regulations?	Action
Yes	Return to the troubleshooting of the specific error and continue with the next procedure.
No	Adjust the power supply, see "5.1.2 Repair procedures" [▶ 213].

To check the wiring between the outdoor unit and the indoor unit

- 1 Check that all wires are properly connected and that all connectors are fully plugged-in.
- 2 Check that no connectors or wires are damaged.
- 3 Check that the wiring corresponds with the wiring diagram, see ["7.2 Wiring diagram"](#) [▶ 235].



INFORMATION

Correct the wiring as needed.

Is the problem solved?	Action
Yes	No further actions required.
No	Return to the troubleshooting of the specific error and continue with the next procedure.

5.1.2 Repair procedures

To adjust the power supply

- 1 Make sure that the power source is in line with the requirements described in the databook.
- 2 Adjust the power supply within 50 Hz ± 3%.

Is the problem solved?	Action
Yes	No further actions required.

Is the problem solved?	Action
No	Return to the troubleshooting of the specific error and continue with the next procedure.

To correct the wiring from the main power supply terminal to the indoor unit power supply terminal

Prerequisite: Stop the unit operation via the user interface.

Prerequisite: Turn OFF the respective circuit breaker.

Prerequisite: Remove the required plate work, see "[4.14 Plate work](#)" [▶ 157].

- 1 Make sure that all wires are firmly and correctly connected, see "[7.2 Wiring diagram](#)" [▶ 235].
- 2 Check the continuity of all wires.
- 3 Replace any damaged or broken wires.



INFORMATION

If applicable, also check the electrical components between the main power supply terminal and the indoor unit power supply terminal (e.g. intermediate terminal, noise filter, fuse, ...).

Is the problem solved?	Action
Yes	No further actions required.
No	Return to the troubleshooting of the specific error and continue with the next procedure.

5.2 Refrigerant circuit

5.2.1 Checking procedures



INFORMATION

It is recommended to perform the checks in the listed order.

To check if the stop valves are open

Prerequisite: Remove the required plate work, see "[4.14 Plate work](#)" [▶ 157].

- 1 Remove the caps.

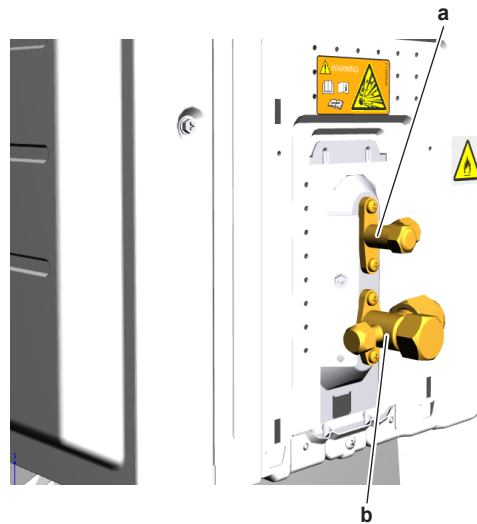

- a** Liquid stop valve
b Gas stop valve

2 Check if the stop valves are completely open.

The refrigerant circuit stop valves are open?	Action
Yes	Return to the troubleshooting of the specific error and continue with the next procedure.
No	Open the stop valves of the refrigerant circuit, see " 5.2.2 Repair procedures " [▶ 219].

To check if the refrigerant circuit is clogged

Prerequisite: Stop the unit operation via the user interface.

Prerequisite: Turn OFF the respective circuit breaker.

- 1** Wait for the refrigerant to reach the outdoor temperature.
- 2** Check that all field piping is done according to the refrigeration practice and installation manual:
 - Correct piping diameters
 - Piping distance limits are followed
 - NO pipes are squeezed
 - NO short radius bends
- 3** Connect a manometer to the service port.
- 4** Turn ON the power of the unit.
- 5** Activate **Heating** operation via the user interface.
- 6** Read the pressure on the pressure gauge. If, at the start of the unit operation, the pressure is high or very low, the refrigerant circuit might be clogged.
- 7** On the refrigerant liquid piping (between the indoor unit heat exchanger and the outdoor unit heat exchanger (coil)), using a contact thermometer, measure the temperature before and after every restricting device. If a big temperature difference is measured (>2.5~4K), an internal pipe obstruction may be present at this location.



INFORMATION

Focus on positions with a potential risk for clogging such as:

- Filters
- Valves
- Brazing points
- ...



INFORMATION

A bigger temperature drop before and after the expansion valve can be normal, however excessive ice is indicating a malfunction of the expansion valve or internal obstruction of the valve (dirt or ice build up in case of humidity in the system).

Temperature drop found?	Action
Yes	Replace the clogged part, see "5.2.2 Repair procedures" [▶ 219].
No	Return to the troubleshooting of the specific error and continue with the next procedure.

To check if the refrigerant circuit is correctly charged

Due to the relationship to pressure control and electronic expansion valve control, the amount of refrigerant needs to be examined according to operating conditions.

Refer to the procedures shown below for correct examination.

Refrigerant overcharge diagnosis

- 1 High pressure rises. Consequently, overload control is conducted to cause insufficient cooling capacity.
- 2 The superheated degree of suction gas lowers (or the wet operation is performed). Consequently, the compressor consumes more power and is noisy (before over-current relay trips).
- 3 The subcooling degree of refrigerant in liquid form rises (values >4~5K are NOT normal).

Cooling

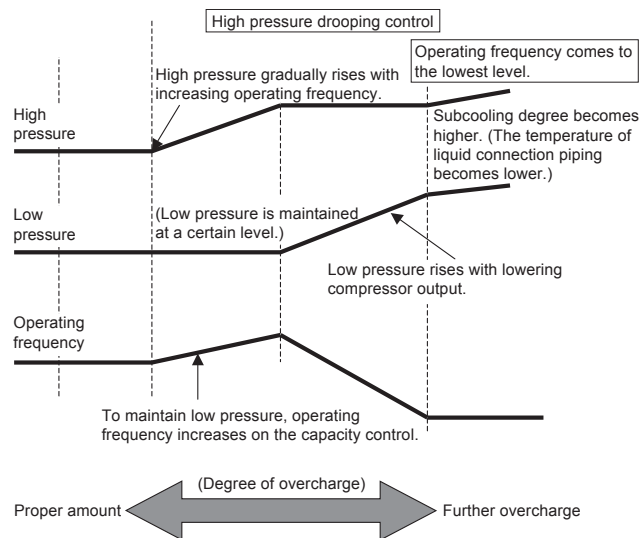

Heating

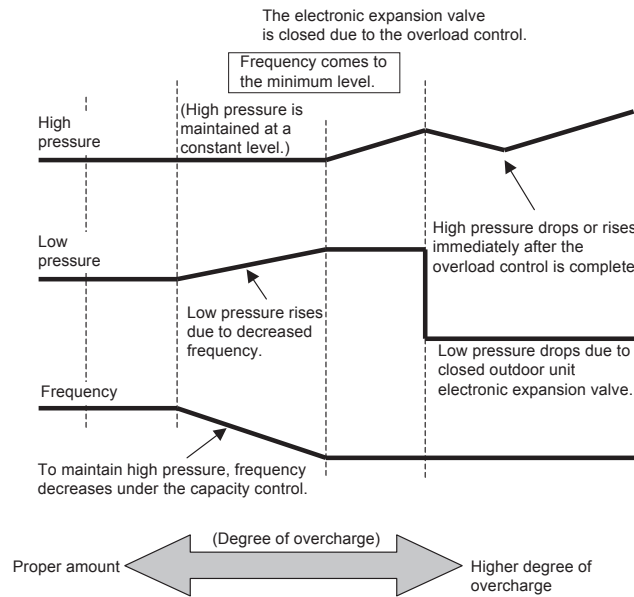

Refrigerant shortage diagnosis

- 1 The superheated degree of suction gas rises. Consequently, the compressor discharge gas temperature becomes higher than normal.
- 2 The superheated degree of suction gas rises. Consequently, the electronic expansion valve turns open more than normal or completely open for average output.
- 3 Low pressure drops to cause the unit not to reach cooling capacity (or heating capacity).

Cooling

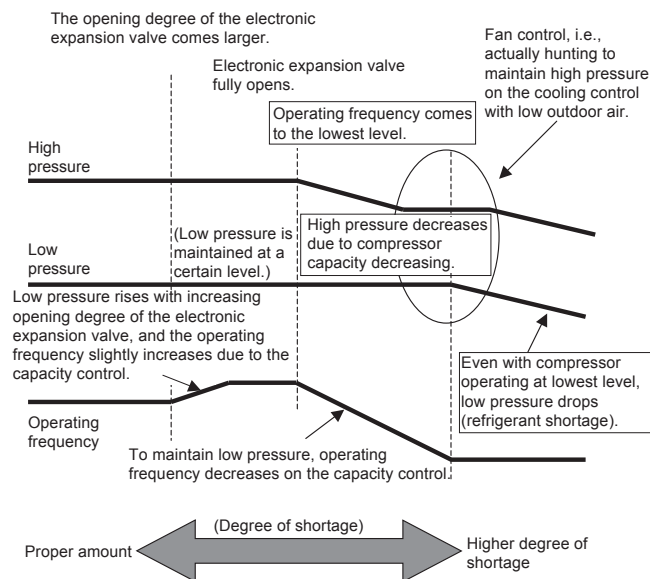

Heating

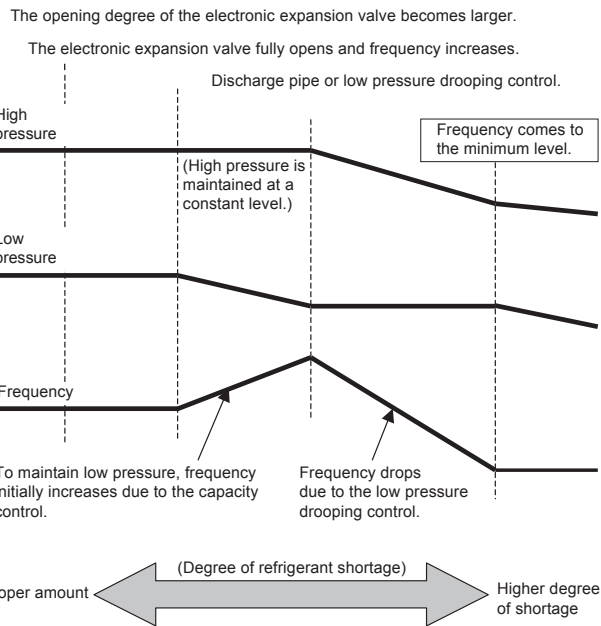

Is the refrigerant circuit charged correctly?	Action
Yes	Return to the troubleshooting of the specific error and continue with the next procedure.
No	Add or recuperate refrigerant until correctly charged, see "5.2.2 Repair procedures" [▶ 219].

To check for non-condensables in the refrigerant circuit

Prerequisite: Stop the unit operation via the user interface.

Prerequisite: Turn OFF the respective circuit breaker.

- 1 Wait for the refrigerant to reach the outdoor temperature.
- 2 Connect a manometer to the service port.
- 3 Measure the pressure of the refrigerant. The measured pressure converted into saturated temperature MUST be in line with the expected pressure / saturated temperature at current ambient temperature.
- 4 If the measured pressure is significantly higher (>5K), non-condensables gasses are most likely present in the refrigerant.

Any non-condensables found in the refrigerant circuit?	Action
Yes	To replace the refrigerant, see "5.2.2 Repair procedures" [▶ 219].
No	Return to the troubleshooting of the specific error and continue with the next procedure.

To perform a pressure test of the refrigerant circuit

- 1 Perform a pressure test in line with local legislation.

Is the pressure in the refrigerant circuit correct?	Action
Yes	Return to the troubleshooting of the specific error and continue with the next procedure.
No	Replace the leaking part of the refrigerant circuit, see "5.2.2 Repair procedures" [▶ 219].

To check if the refrigerant field piping is compliant with the regulations

- 1 Check if the refrigerant field piping is compliant with the regulations. Adjust as needed. See installation manual for field piping specifications.

Is the problem solved?	Action
Yes	No further actions required.
No	Return to the troubleshooting of the specific error and continue with the next procedure.

5.2.2 Repair procedures

To open the stop valves of the refrigerant circuit

Prerequisite: Remove the required plate work, see ["4.14 Plate work"](#) [▶ 157].

- 1 Remove the caps.

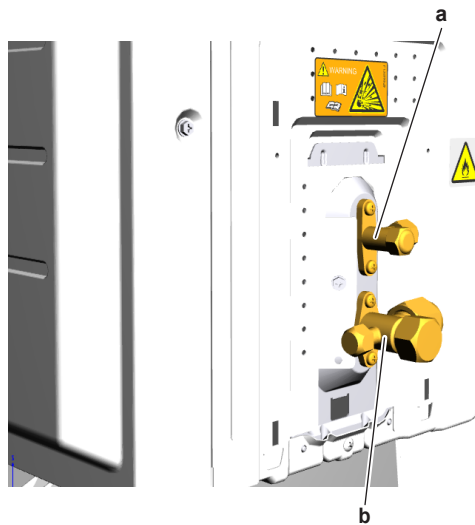

- a** Liquid stop valve
b Gas stop valve

- 2 Completely open the stop valves by screwing the stop valve screw counterclockwise.

Is the problem solved?	Action
Yes	No further actions required.
No	Return to the troubleshooting of the specific error and continue with the next procedure.

To replace the clogged/leaking part of the refrigerant circuit

- 1 See the correct procedure for the component that needs to be repaired. See also "Repair information" [▶ 221] for more details.

Is the problem solved?	Action
Yes	No further actions required.
No	Return to the troubleshooting of the specific error and continue with the next procedure.

To recuperate the refrigerant

Prerequisite: Stop the unit operation via the user interface.

- 1 Manually open all expansion valves.
- 2 Connect the vacuum pump, manifold, recovery unit, and refrigerant bottle to the service port of the refrigerant circuit as shown below.

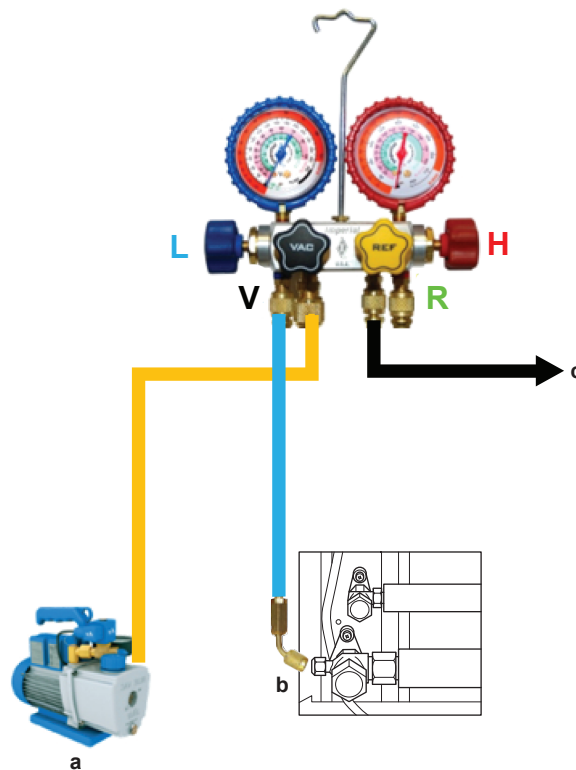

- a Vacuum pump
- b Connect flexible hose to service port
- c To recovery pump
- L Low pressure
- H High pressure
- V Vacuum
- R Refrigerant

- 3 To add refrigerant, see "5.2.2 Repair procedures" [▶ 219].

Is the problem solved?	Action
Yes	No further actions required.
No	Return to the troubleshooting of the specific error and continue with the next procedure.

To add refrigerant

- 1 See the installer reference guide for the correct procedure.

Is the problem solved?	Action
Yes	No further actions required.
No	Return to troubleshooting of the specific error and continue with the next procedure.

Repair information**Refrigerant piping handling**

- Make sure that the applied pressure is never higher than the unit design pressure indicated on the nameplate (PS).
- Work according to the F-gas regulation and/or local regulations.
- Make sure the correct amount of refrigerant is charged after repair according to the F-gas regulation label on the unit (factory + additional where required).
- Make sure to use the appropriate equipment and tools according to the refrigerant and unit type.
- R32 can be charged in gas phase.
- Make sure to use a digital scale (no charging cylinder).
- Execute correct vacuum drying procedure after repair:
 - When using an electronic vacuum gauge with an absolute pressure readout, a pressure of minimal 2000 micron / 2 Torr / 266 Pa MUST be reached. This pressure should stay stable for 30 minutes when vacuum pump is NOT running. If vacuum pressure CANNOT be held, most likely there is still moisture in the system. Again run the vacuum pump for 1~2 hours to a pressure (absolute pressure readout) lower than 2000 micron / 2 torr / 266 Pa. If target pressure CANNOT be reached, again check for leaks.
 - Connect the unit according to the available service ports.
 - Use related field setting where necessary to open expansion valve / solenoid valve.

To perform refrigerant pump down operation

The unit is equipped with an automatic pump down operation which will collect all refrigerant from the field piping and indoor unit in the outdoor unit. To protect the environment, make sure to perform the following pump down operation when relocating the unit.

**DANGER: RISK OF EXPLOSION**

Pump down – Refrigerant leakage. If you want to pump down the system, and there is a leak in the refrigerant circuit:

- Do NOT use the unit's automatic pump down function, with which you can collect all refrigerant from the system into the outdoor unit. **Possible consequence:** Self-combustion and explosion of the compressor because of air going into the operating compressor.
- Use a separate recovery system so that the unit's compressor does NOT have to operate.

**CAUTION**

Some outdoor units are equipped with a low pressure switch to protect the compressor by switching it off. NEVER short-circuit the low pressure switch during pump down operation.

- 1 Remove the refrigerant connection cover, see "4.14 Plate work" [▶ 157].
- 2 Remove the cap from the stop valves.
- 3 Perform pump down operation, see installer reference guide for the correct procedure.
- 4 After 5~10 minutes (after only 1~2 minutes in case temperature $\leq -10^{\circ}\text{C}$), close the liquid stop valve using a hexagonal wrench.
- 5 Check the manifold if vacuum is reached. Close the gas stop valve and stop forced cooling operation.

Refrigerant piping repair

- Make sure to cover open pipe ends during repair so no dust or moisture can enter.
- Make sure to re-apply insulation removed during repair.
- Pipe expansion / flare making:
 - Remove any burrs on the cut surface using the correct tool such as reamer or scraper (note that excessive deburring can thin the pipe walls and cause cracking of the pipe).
 - Make sure the flare has the correct size (use a flare gauge).
 - Make sure no particles remain in the piping.
 - Apply just a drop of refrigerant oil on the inner surface of the flare.
 - Make sure the flare connection is tightened with the correct torque (torque values refer to installation manual).
- Brazing:
 - Use the correct brazing tool.
 - Use a phosphor copper filler metal (silver composition of 0 to 2%). Do not use flux material.
 - Flush the piping before brazing with nitrogen to avoid oxidation of the inside of the copper tubes (nitrogen purity $\geq 99.99\%$).

Refrigerant circuit vacuuming - general advice

The effectiveness of the vacuum drying depends on many factors. Besides following the correct procedures and using equipment that is well maintained, the ambient conditions at which the vacuum is done MUST be considered. If there is moisture in the refrigerant and the ambient temperature is lower, the vacuum pressure that MUST be reached to allow the evaporation of the moisture will need to be lower. In some cases the vacuum pump may NOT be able to achieve these pressures. If possible, heat the locations where moisture is expected.

As a general target, the values below CAN be used as reference to achieve a proper vacuum on the unit:

- Absolute pressure below 270 Pa MUST be reached. The time needed for the pressure to lower is also depending on the moisture amount. If it takes very long or it is hard to reach the pressure, this MIGHT be an indication of moisture presence, so the vacuum pump will need to run longer.

- After stopping the vacuum pump, the absolute pressure **MUST** be kept below 270 Pa for at least 30 minutes, without a significant increase of pressure. If pressure increases significantly, this is an indication of the presence of moisture in the system.
- If multiple vacuum cycles need to be performed, break the vacuum between the cycles using dry nitrogen.

Depending on the site conditions, as mentioned above, lower pressure values **MIGHT** be needed to allow the boiling of the moisture in the system. The table below shows the boiling point of water for different absolute pressures.

Pressure (absolute)		Boiling point
Micron / Torr	Mbar / Pa	°C
760000 / 760	1013 / 101325	100
50000 / 50	66 / 6666	38
10000 / 10	13 / 1333	11
2000 / 2	2.6 / 266	-10
1000 / 1	1.33 / 133	-18
500 / 0.5	0.66 / 66	-24

5.3 External factors

5.3.1 Checking procedures

To check the outdoor temperature

- 1 The temperature ranges for the different operation modes of the unit can be found in the databook on Business Portal.



INFORMATION

If the outdoor temperature is outside the range of operation, the unit may NOT operate or may NOT deliver the required capacity.

Is the outdoor temperature within the operating range?	Action
Yes	Return to the troubleshooting of the specific error and continue with the next procedure.
No	Wait for the outdoor temperature to return within the operating range.

To check for objects that may block the airflow

- 1 Check for the presence of object(s) near the indoor unit that may block the airflow. Remove the object(s) as needed.

Is the problem solved?	Action
Yes	No further actions required.
No	Return to the troubleshooting of the specific error and continue with the next procedure.

To check the required space around the outdoor unit heat exchanger

- 1 Check if the space around the outdoor unit heat exchanger is sufficient. See the installation manual for the required space specifications. Adjust as needed.

Is the problem solved?	Action
Yes	No further actions required.
No	Return to the troubleshooting of the specific error and continue with the next procedure.

6 Maintenance



NOTICE

General maintenance/inspection checklist. Next to the maintenance instructions in this chapter, a general maintenance/inspection checklist is also available on the Daikin Business Portal (authentication required).

The general maintenance/inspection checklist is complementary to the instructions in this chapter and can be used as a guideline and reporting template during maintenance.

6.1 To clean the outdoor unit heat exchanger

- 1 Straighten the hair fins.
- 2 Clear the outdoor unit heat exchanger from dust, leaves,... using a fin-comb or compressed air/N₂.



CAUTION

Avoid bending or damaging the hair fins of the outdoor unit heat exchanger during the cleaning process.

Do NOT use a high-pressure washer.

Is the problem solved?	Action
Yes	No further actions required.
No	Return to the troubleshooting of the specific error and continue with the next procedure.

6.2 To clean the indoor unit heat exchanger

- 1 Straighten the hair fins.
- 2 Clear the indoor unit heat exchanger from dust, ... using a fin-comb or compressed air/N₂.



CAUTION

Avoid bending or damaging the hair fins of the indoor unit heat exchanger during the cleaning process.

Is the problem solved?	Action
Yes	No further actions required.
No	Return to the troubleshooting of the specific error and continue with the next procedure.

6.3 To clean the indoor unit heat exchanger in extreme condition

When cleaning the indoor unit heat exchanger (contaminated by cooking oil, ...), make sure to:

- Use proper field supply cleaning agent which is suitable for cleaning heat exchangers and drain pans.
- Clearly follow the instructions of local supply cleaning agent and to NOT use household cleaning agents.
- Rinse the heat exchanger and drain pan with water after the cleaning process.



CAUTION

Rinse out the cleaning agent until there is NO cleaning agent left. Otherwise, the corrosion of heat exchanger and drain pan may occur. Pay attention to the cleaning agent that may also corrode other materials of the indoor unit (Aluminium, copper, plastic, ABS, ...).

Is the problem solved?	Action
Yes	No further actions required.
No	Return to the troubleshooting of the specific error and continue with the next procedure.

6.4 To clean the indoor unit and wireless remote control



WARNING

Improper detergents or cleaning procedure may cause damage on plastic components or water leakage. Splashed detergent on electric components, such as motors, may cause failure, smoke or ignition.



DANGER: RISK OF ELECTROCUTION

Before cleaning, be sure to stop the operation, turn the breaker OFF or pull out the supply cord. Otherwise, an electrical shock and injury may result. In case the unit is equipped with a refrigerant leakage sensor, turn the power supply breaker back ON immediately after cleaning in order to maintain detection functionality.



NOTICE

- Do NOT use gasoline, benzene, thinner, polishing powder or liquid insecticide. **Possible consequence:** Discoloration and deformation.
- Do NOT use water or air of 40°C or higher. **Possible consequence:** Discoloration and deformation.
- Do NOT use polishing compounds.
- Do NOT use a scrubbing brush. **Possible consequence:** The surface finishing peels off.
- As an end user, you may NEVER clean inside parts of the unit by yourself; this work must be performed by a qualified service person. Contact your dealer.

- 1 Clean with a soft cloth. If it is difficult to remove stains, use water or a neutral detergent.

6.5 To clean the front panel

Floor standing units



WARNING

Do NOT let the indoor unit get wet. **Possible consequence:** Electrical shock or fire.



NOTICE

- Do NOT use gasoline, benzene, thinner polishing powder or liquid insecticide. **Possible consequence:** Discoloration and deformation.
- Do NOT use water or air of 50°C or higher. **Possible consequence:** Discoloration and deformation.
- Do NOT scrub firmly when washing the blade with water. **Possible consequence:** The surface sealing peels off.

You can remove the front panel to clean it.



CAUTION

Be careful when opening and handling the front panel; sharp edge of the front panel may cause injury.

- 1 Slide both sliders in the direction of the arrows until they click.

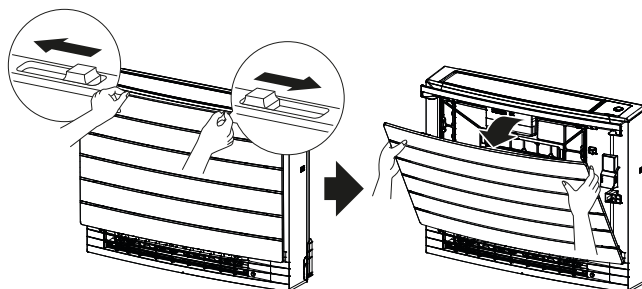

- 2 Open the front panel and undo the string.

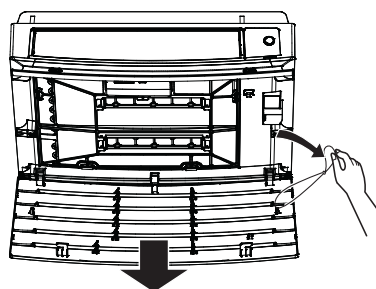

- 3 Remove the front panel.
- 4 Wipe it with a soft cloth soaked in water.
- 5 Let it dry in the shade after washing.
- 6 To reinstall and close the front panel, see "[4.14 Plate work](#)" [▶ 157].

Wall mounted units

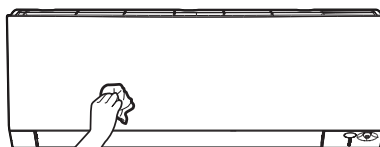

- 1 Clean the front panel with a soft cloth. If it is difficult to remove stains, use water or a neutral detergent.

6.6 To clean the air filters

Floor standing units

REMOVE THE FILTER

- 1 Remove the front panel, see "4.14 Plate work" [▶ 157].
- 2 Carefully remove the air filter tabs from the claws (a) on the sides. Hold the air filter by the filter knob (b) and unhook the air filter tab from the claw (c) on the top. Pull the filter up to remove the filter tabs from the claws on the bottom (d).

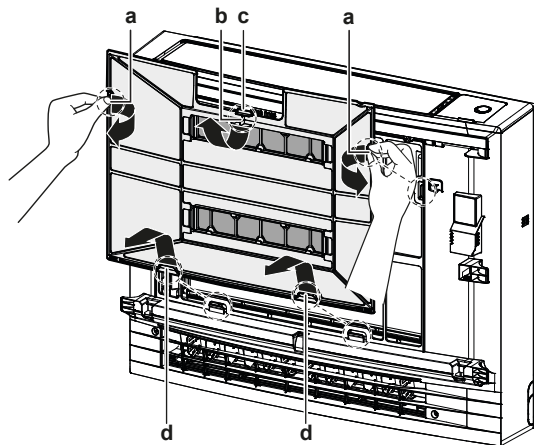

- a Tabs for claws on the side
- b Filter knob
- c Tab for the claw on the top
- d Tabs for claws on the bottom

- 3 Remove both titanium apatite deodorising filters from the claws (4 on each).

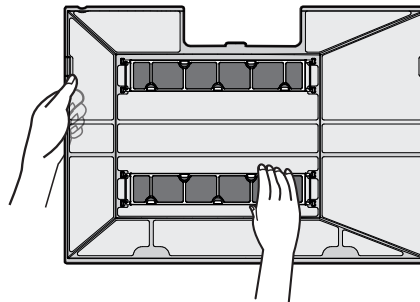

CLEAN THE FILTER

- 1 Wash the air filter with water or clean it with a vacuum cleaner.

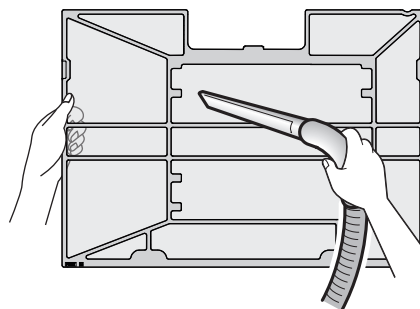



INFORMATION

- If the dust does NOT come off easily, wash them with a neutral detergent diluted in lukewarm water. Dry the air filters in the shade.
- It is recommended to clean the air filters every 2 weeks.

INSTALL THE FILTER

- 1 Hook both titanium apatite deodorising filters to the claws (4 on each).

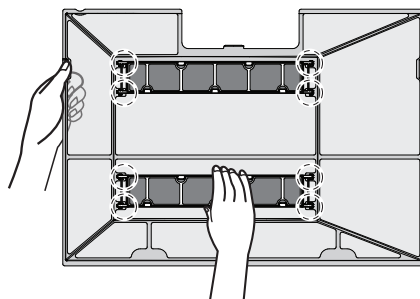

- 2 Insert the filter tabs to the claws on the bottom (d). Hold the air filter by the filter knob (b) and insert the air filter tab to the claw (c) on the top. Insert the air filter tabs to the claws (a) on the sides. Make sure the air filter is securely fixed in all positions.

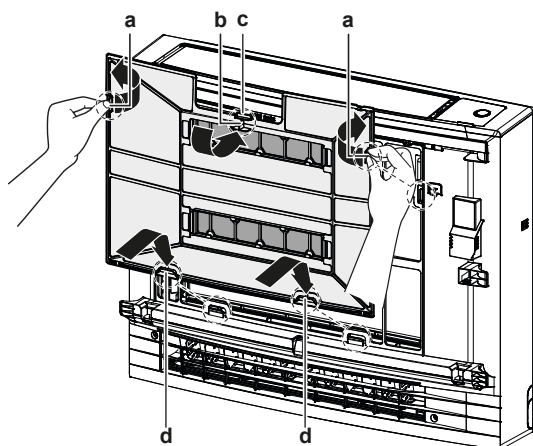

- a Tabs for claws on the side
- b Filter knob
- c Tab for the claw on the top
- d Tabs for claws on the bottom

- 3 Install the front panel, see "4.14 Plate work" [▶ 157].

Wall mounted units

- 1 Push the tab at the centre of each air filter, then pull it down.
- 2 Pull out the air filters.

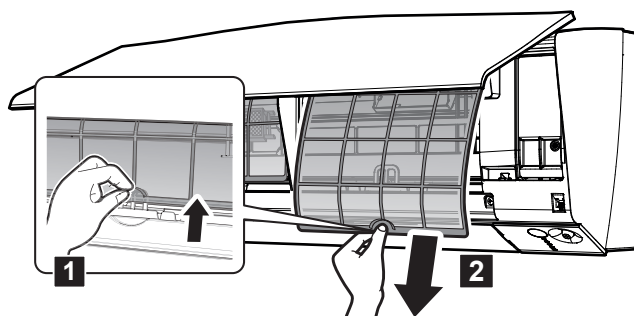

Note: (class 50~71) The titanium apatite deodorising filter and the silver allergen removal air purifying filter **MUST** be removed before cleaning the air filter.

- 3 Remove the titanium apatite deodorising filter and the silver particle filter from all 4 claws.

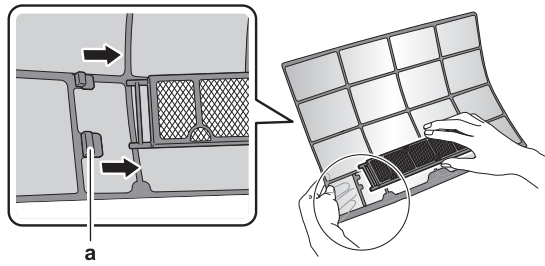

a Claw

- 4 Wash the air filters with water or clean them with a vacuum cleaner.

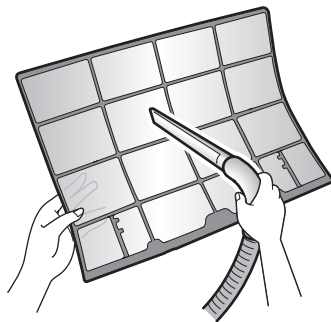

- 5 Soak in lukewarm water for about 10 to 15 minutes.

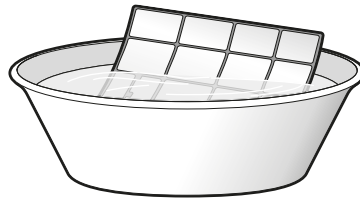

INFORMATION

- If the dust does NOT come off easily, wash them with a neutral detergent diluted in lukewarm water. Dry the air filters in the shade.
- It is recommended to clean the air filters every 2 weeks.

Is the problem solved?	Action
Yes	No further actions required.
No	Return to the troubleshooting of the specific error and continue with the next procedure.

6.7 To clean the titanium apatite deodorising filter and the silver particle filter (Ag-ion filter)

FTXM-R units



INFORMATION

Clean the filter with water every 6 months.

1 Remove:

- for class 15~42: silver allergen removal air purifying filter from the tabs

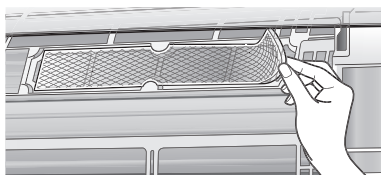

- for class 50~71: titanium apatite deodorising filter and the silver allergen removal air purifying filter from all 4 claws.

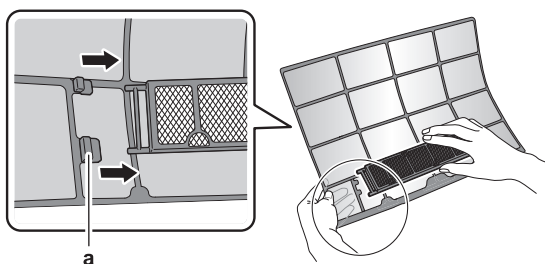

a Claw

2 Remove the dust from the filter with a vacuum cleaner.

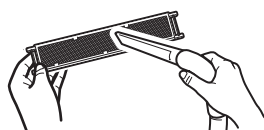

3 Soak the filter for 10 to 15 minutes in warm water.

Note: (class 50~71) Do NOT remove the filter from the frame.

Class 15~42



Class 50~71



4 After washing, shake off remaining water and dry the filter in the shade. Do NOT wring out the filter when removing water.

ATXM-R units



INFORMATION

Clean the filter with water every 6 months.

1 Remove:

- **for class 20~35:** silver allergen removal air purifying filter from the tabs

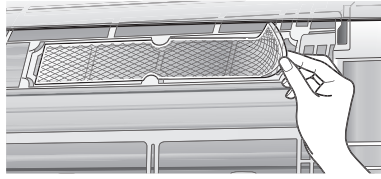

- **for class 50:** titanium apatite deodorising filter and the silver allergen removal air purifying filter from all 4 claws.

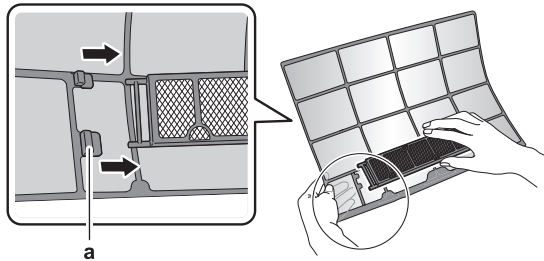

a Claw

- 2 Remove the dust from the filter with a vacuum cleaner.

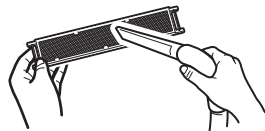

- 3 Soak the filter for 10 to 15 minutes in warm water.

Note: (class 50) Do NOT remove the filter from the frame.

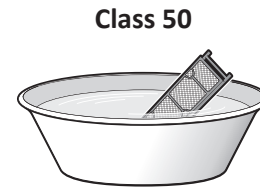
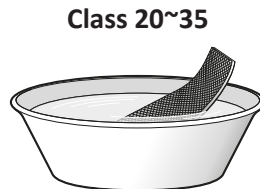

- 4 After washing, shake off remaining water and dry the filter in the shade. Do NOT wring out the filter when removing water.

6.8 To replace the titanium apatite deodorising filter and the silver particle filter (Ag-ion filter)



INFORMATION

Replace the filter every 3 years.

To order titanium apatite deodorising filter or silver particle filters, contact your dealer.

Item	Part number
Titanium deodorising filter	KAF970A46
Silver particle filter	KAF057A41

FTXM-R units

- 1 Remove the filter from the tabs (class 15~42) or frame (class 50~71) and replace the filter with a new one.

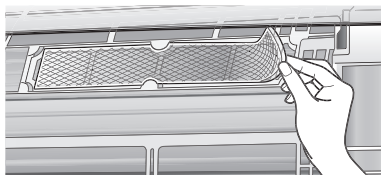
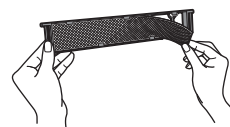
Class 15~42**Class 50~71****INFORMATION**

- Do NOT throw away the filter frame, but use it again.
- Dispose of the old filter as non-flammable waste.

ATXM-R units

- 1 Remove the filter from the tabs (class 20~35) or frame (class 50) and replace the filter with a new one.

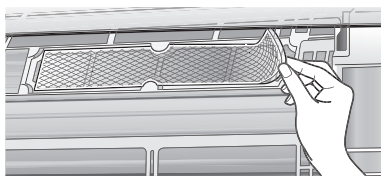
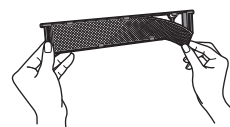
Class 20~35**Class 50****INFORMATION**

- Do NOT throw away the filter frame, but use it again.
- Dispose of the old filter as non-flammable waste.

7 Technical data

7.1 Detailed information setting mode

7.1.1 Detailed information setting mode: Indoor unit

See the installer reference guide on business portal for more information.

7.1.2 Detailed information setting mode: Outdoor unit

See the installer reference guide on business portal for more information.

7.1.3 Detailed information setting mode: Remote controller

















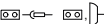

See the installer reference guide on business portal for more information.

7.2 Wiring diagram

7.2.1 Wiring diagram: Indoor unit

Unified wiring diagram legend

For applied parts and numbering, refer to the wiring diagram on the unit. Part numbering is by Arabic numbers in ascending order for each part and is represented in the overview below by "*" in the part code.

Symbol	Meaning	Symbol	Meaning
	Circuit breaker		Protective earth
			
			
	Connection		Protective earth (screw)
	Connector		Rectifier
	Earth		Relay connector
	Field wiring		Short-circuit connector
	Fuse		Terminal
	Indoor unit		Terminal strip
	Outdoor unit		Wire clamp
	Residual current device		

Symbol	Colour	Symbol	Colour
BLK	Black	ORG	Orange
BLU	Blue	PNK	Pink
BRN	Brown	PRP, PPL	Purple
GRN	Green	RED	Red
GRY	Grey	WHT	White
SKY BLU	Sky blue	YLW	Yellow

Symbol	Meaning
A*P	Printed circuit board
BS*	Pushbutton ON/OFF, operation switch
BZ, H*O	Buzzer
C*	Capacitor
AC*, CN*, E*, HA*, HE*, HL*, HN*, HR*, MR*_A, MR*_B, S*, U, V, W, X*A, K*R_*, NE	Connection, connector
D*, V*D	Diode
DB*	Diode bridge
DS*	DIP switch

Symbol	Meaning
E*H	Heater
FU*, F*U, (for characteristics, refer to PCB inside your unit)	Fuse
FG*	Connector (frame ground)
H*	Harness
H*P, LED*, V*L	Pilot lamp, light emitting diode
HAP	Light emitting diode (service monitor green)
HIGH VOLTAGE	High voltage
IES	Intelligent eye sensor
IPM*	Intelligent power module
K*R, KCR, KFR, KHuR, K*M	Magnetic relay
L	Live
L*	Coil
L*R	Reactor
M*	Stepper motor
M*C	Compressor motor
M*F	Fan motor
M*P	Drain pump motor
M*S	Swing motor
MR*, MRCW*, MRM*, MRN*	Magnetic relay
N	Neutral
n=*, N=*	Number of passes through ferrite core
PAM	Pulse-amplitude modulation
PCB*	Printed circuit board
PM*	Power module
PS	Switching power supply
PTC*	PTC thermistor
Q*	Insulated gate bipolar transistor (IGBT)
Q*C	Circuit breaker
Q*DI, KLM	Earth leak circuit breaker
Q*L	Overload protector
Q*M	Thermo switch
Q*R	Residual current device
R*	Resistor
R*T	Thermistor
RC	Receiver
S*C	Limit switch

Symbol	Meaning
S*L	Float switch
S*NG	Refrigerant leak detector
S*NPH	Pressure sensor (high)
S*NPL	Pressure sensor (low)
S*PH, HPS*	Pressure switch (high)
S*PL	Pressure switch (low)
S*T	Thermostat
S*RH	Humidity sensor
S*W, SW*	Operation switch
SA*, F1S	Surge arrester
SR*, WLU	Signal receiver
SS*	Selector switch
SHEET METAL	Terminal strip fixed plate
T*R	Transformer
TC, TRC	Transmitter
V*, R*V	Varistor
V*R	Diode bridge, Insulated-gate bipolar transistor (IGBT) power module
WRC	Wireless remote controller
X*	Terminal
X*M	Terminal strip (block)
Y*E	Electronic expansion valve coil
Y*R, Y*S	Reversing solenoid valve coil
Z*C	Ferrite core
ZF, Z*F	Noise filter

FTXM20~42R + ATXM25+35R



INFORMATION

The diagrams shown in this manual may be incorrect due to changes/updates to the unit. Correct diagrams are supplied with the unit and can also be found in the technical data book.

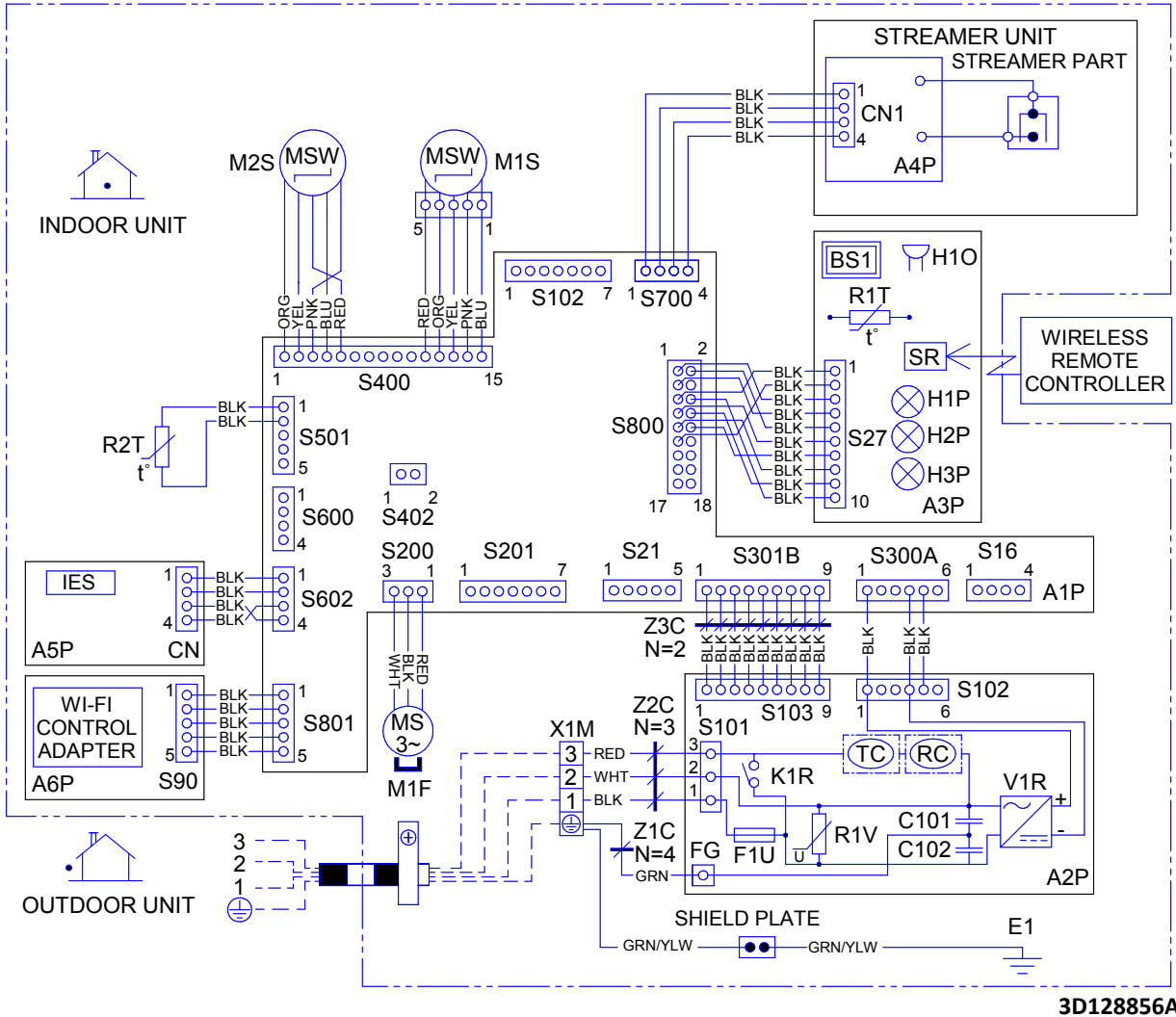

3D128856A

FTXM50~71R + ATXM50R



INFORMATION

The diagrams shown in this manual may be incorrect due to changes/updates to the unit. Correct diagrams are supplied with the unit and can also be found in the technical data book.

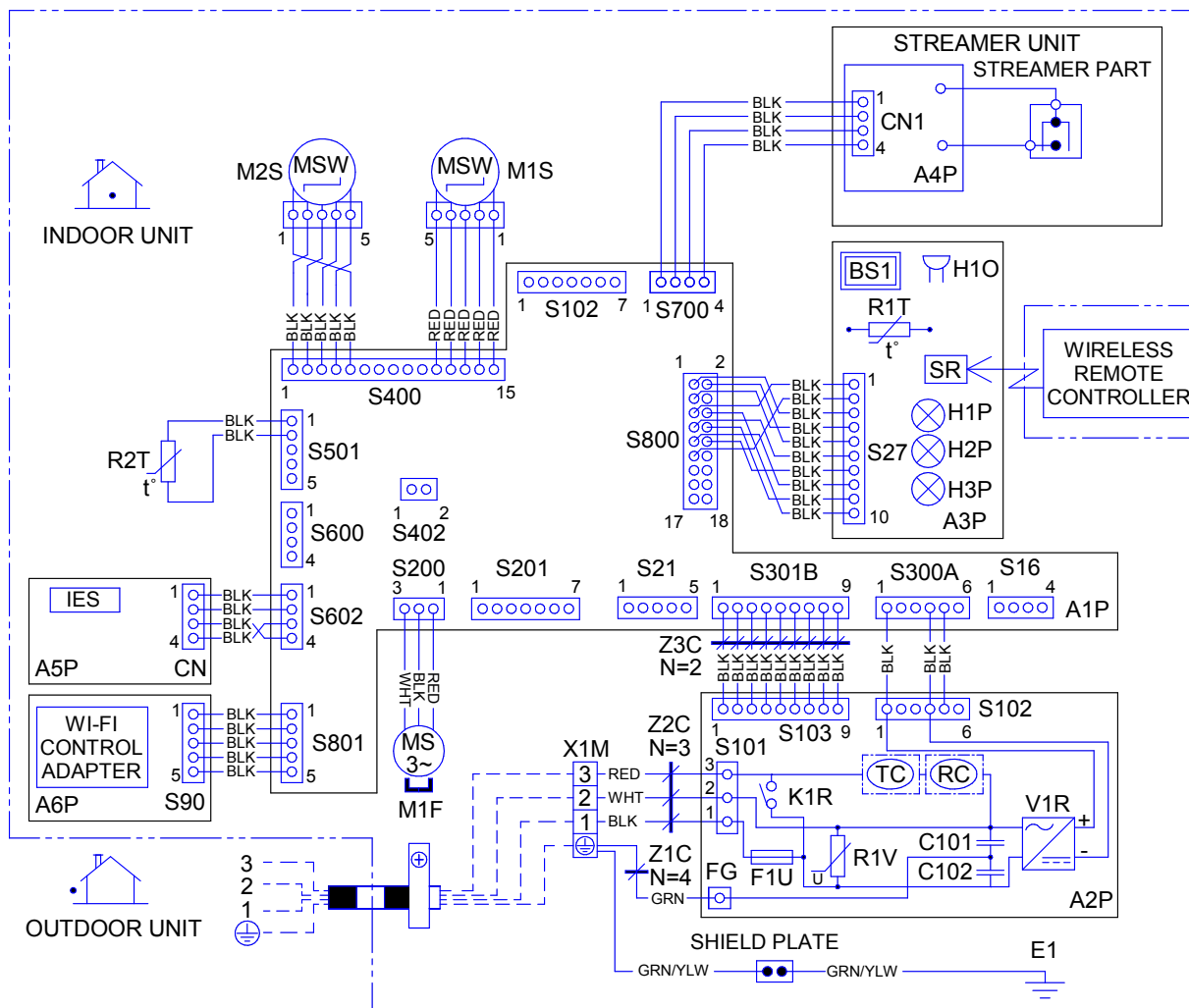

3D130931

FVXM-A



INFORMATION

The diagrams shown in this manual may be incorrect due to changes/updates to the unit. Correct diagrams are supplied with the unit and can also be found in the technical data book.

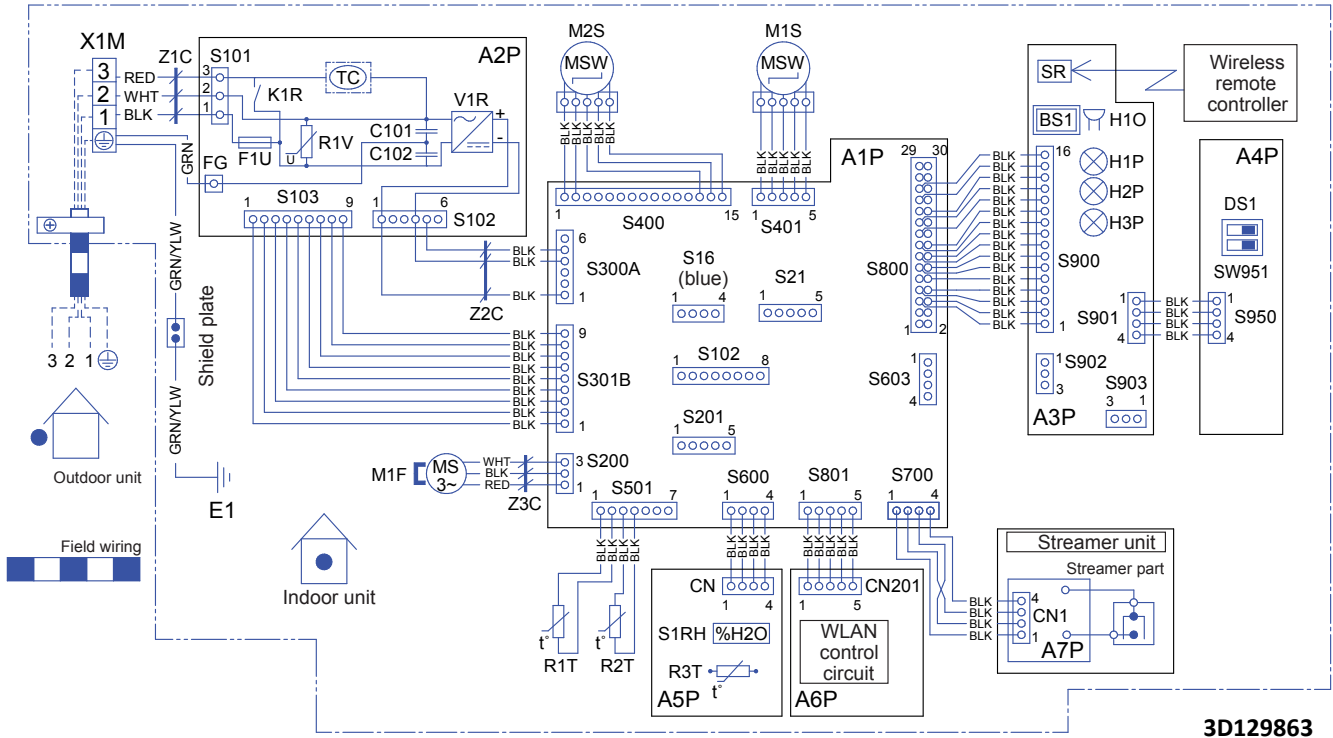

3D129863

FVXM-A9



INFORMATION

The diagrams shown in this manual may be incorrect due to changes/updates to the unit. Correct diagrams are supplied with the unit and can also be found in the technical data book.

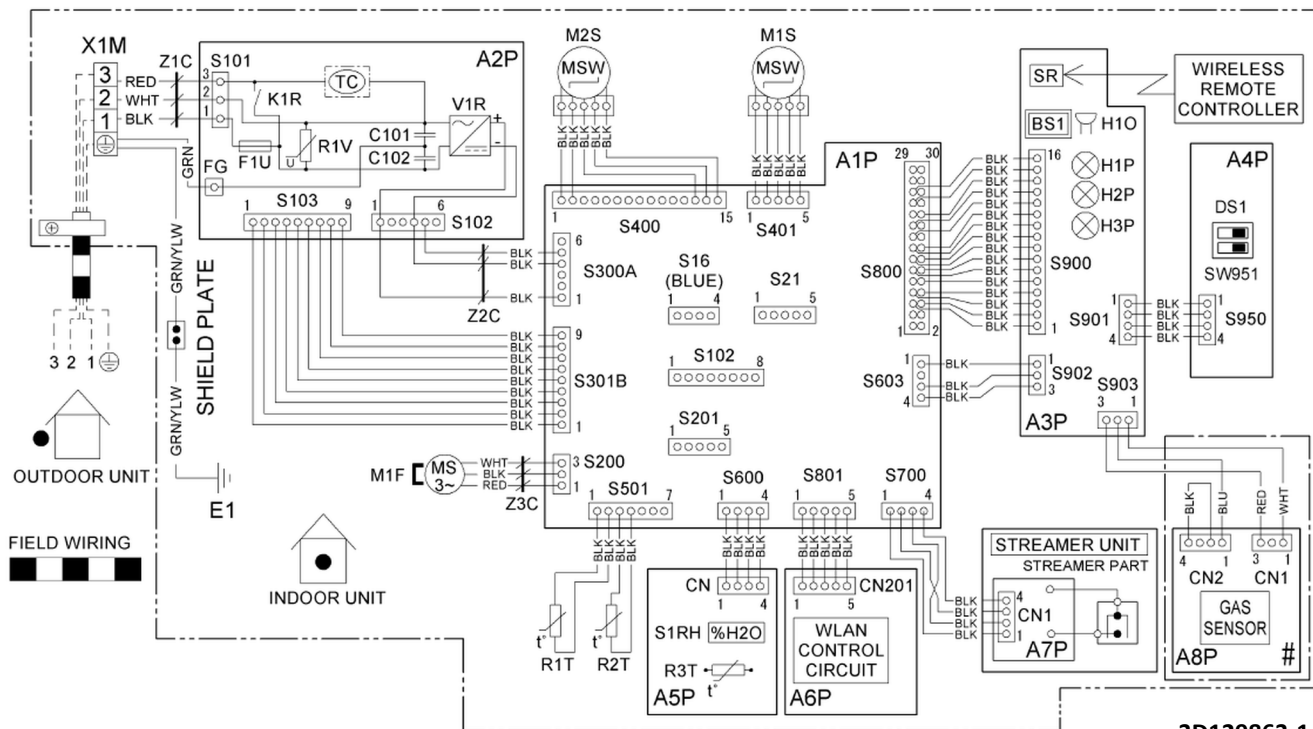















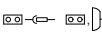



3D129863-1A

7.2.2 Wiring diagram: Outdoor unit

Unified wiring diagram legend

For applied parts and numbering, refer to the wiring diagram on the unit. Part numbering is by Arabic numbers in ascending order for each part and is represented in the overview below by "*" in the part code.

Symbol	Meaning	Symbol	Meaning
	Circuit breaker		Protective earth
			
			
	Connection		Protective earth (screw)
	Connector		Rectifier
	Earth		Relay connector
	Field wiring		Short-circuit connector
	Fuse		Terminal
	Indoor unit		Terminal strip
	Outdoor unit		Wire clamp
	Residual current device		

Symbol	Colour	Symbol	Colour
BLK	Black	ORG	Orange
BLU	Blue	PNK	Pink
BRN	Brown	PRP, PPL	Purple
GRN	Green	RED	Red
GRY	Grey	WHT	White
SKY BLU	Sky blue	YLW	Yellow

Symbol	Meaning
A*P	Printed circuit board
BS*	Pushbutton ON/OFF, operation switch
BZ, H*O	Buzzer
C*	Capacitor
AC*, CN*, E*, HA*, HE*, HL*, HN*, HR*, MR*_A, MR*_B, S*, U, V, W, X*A, K*R_*, NE	Connection, connector
D*, V*D	Diode
DB*	Diode bridge
DS*	DIP switch
E*H	Heater

Symbol	Meaning
FU*, F*U, (for characteristics, refer to PCB inside your unit)	Fuse
FG*	Connector (frame ground)
H*	Harness
H*P, LED*, V*L	Pilot lamp, light emitting diode
HAP	Light emitting diode (service monitor green)
HIGH VOLTAGE	High voltage
IES	Intelligent eye sensor
IPM*	Intelligent power module
K*R, KCR, KFR, KHuR, K*M	Magnetic relay
L	Live
L*	Coil
L*R	Reactor
M*	Stepper motor
M*C	Compressor motor
M*F	Fan motor
M*P	Drain pump motor
M*S	Swing motor
MR*, MRCW*, MRM*, MRN*	Magnetic relay
N	Neutral
n=*, N=*	Number of passes through ferrite core
PAM	Pulse-amplitude modulation
PCB*	Printed circuit board
PM*	Power module
PS	Switching power supply
PTC*	PTC thermistor
Q*	Insulated gate bipolar transistor (IGBT)
Q*C	Circuit breaker
Q*DI, KLM	Earth leak circuit breaker
Q*L	Overload protector
Q*M	Thermo switch
Q*R	Residual current device
R*	Resistor
R*T	Thermistor
RC	Receiver
S*C	Limit switch
S*L	Float switch

Symbol	Meaning
S*NG	Refrigerant leak detector
S*NPH	Pressure sensor (high)
S*NPL	Pressure sensor (low)
S*PH, HPS*	Pressure switch (high)
S*PL	Pressure switch (low)
S*T	Thermostat
S*RH	Humidity sensor
S*W, SW*	Operation switch
SA*, F1S	Surge arrester
SR*, WLU	Signal receiver
SS*	Selector switch
SHEET METAL	Terminal strip fixed plate
T*R	Transformer
TC, TRC	Transmitter
V*, R*V	Varistor
V*R	Diode bridge, Insulated-gate bipolar transistor (IGBT) power module
WRC	Wireless remote controller
X*	Terminal
X*M	Terminal strip (block)
Y*E	Electronic expansion valve coil
Y*R, Y*S	Reversing solenoid valve coil
Z*C	Ferrite core
ZF, Z*F	Noise filter

RXM20~35R + ARXM25+35R



INFORMATION

The diagrams shown in this manual may be incorrect due to changes/updates to the unit. Correct diagrams are supplied with the unit and can also be found in the technical data book.

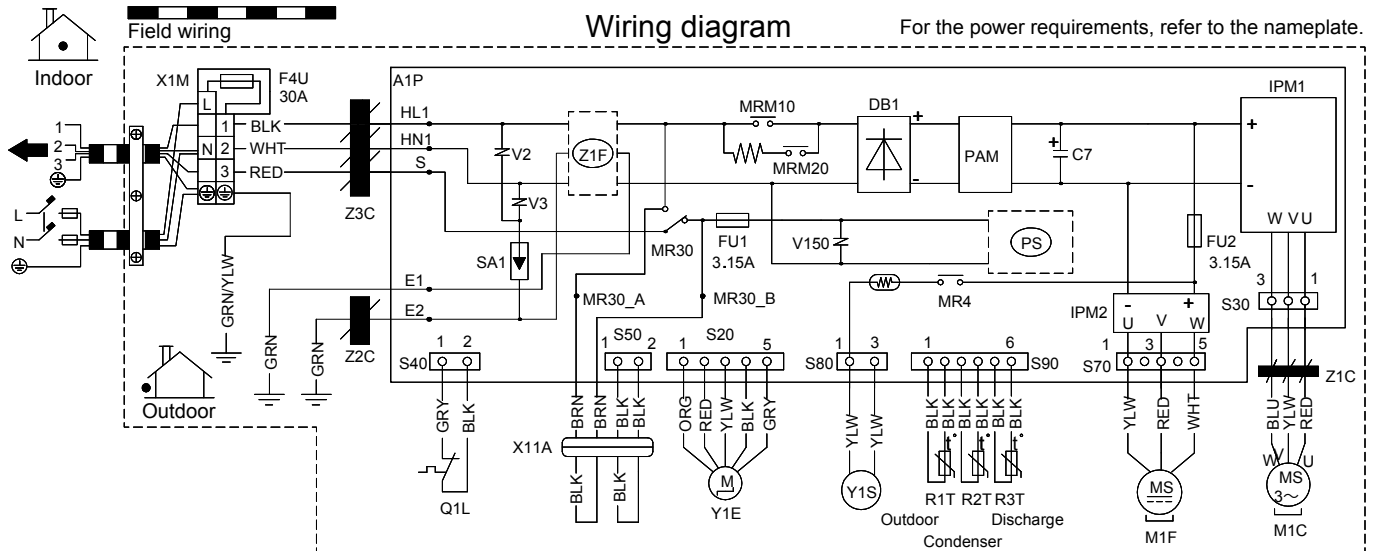

4D120154-1

RXM42R



INFORMATION

The diagrams shown in this manual may be incorrect due to changes/updates to the unit. Correct diagrams are supplied with the unit and can also be found in the technical data book.

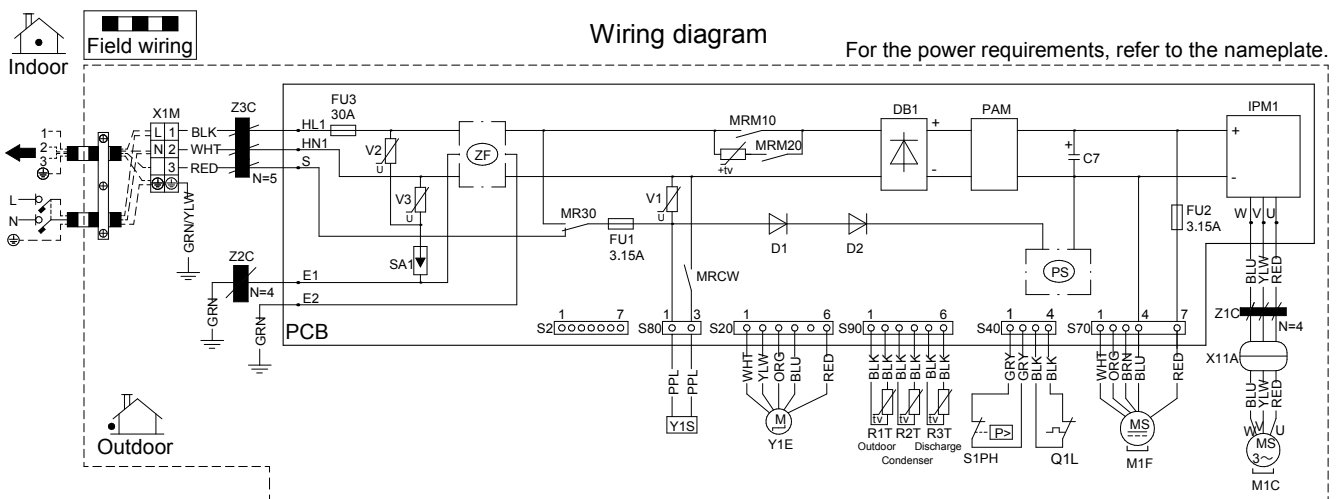

3D130905-1A

RXM50+60R + ARXM50~71R



INFORMATION

The diagrams shown in this manual may be incorrect due to changes/updates to the unit. Correct diagrams are supplied with the unit and can also be found in the technical data book.

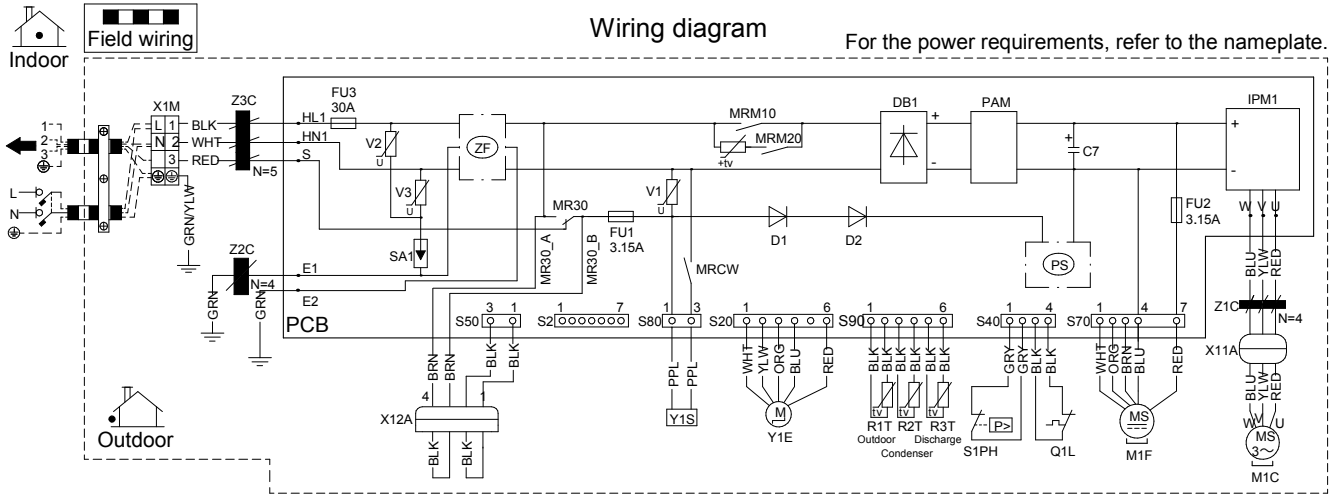

3D130906-1A

RXM71R



INFORMATION

The diagrams shown in this manual may be incorrect due to changes/updates to the unit. Correct diagrams are supplied with the unit and can also be found in the technical data book.

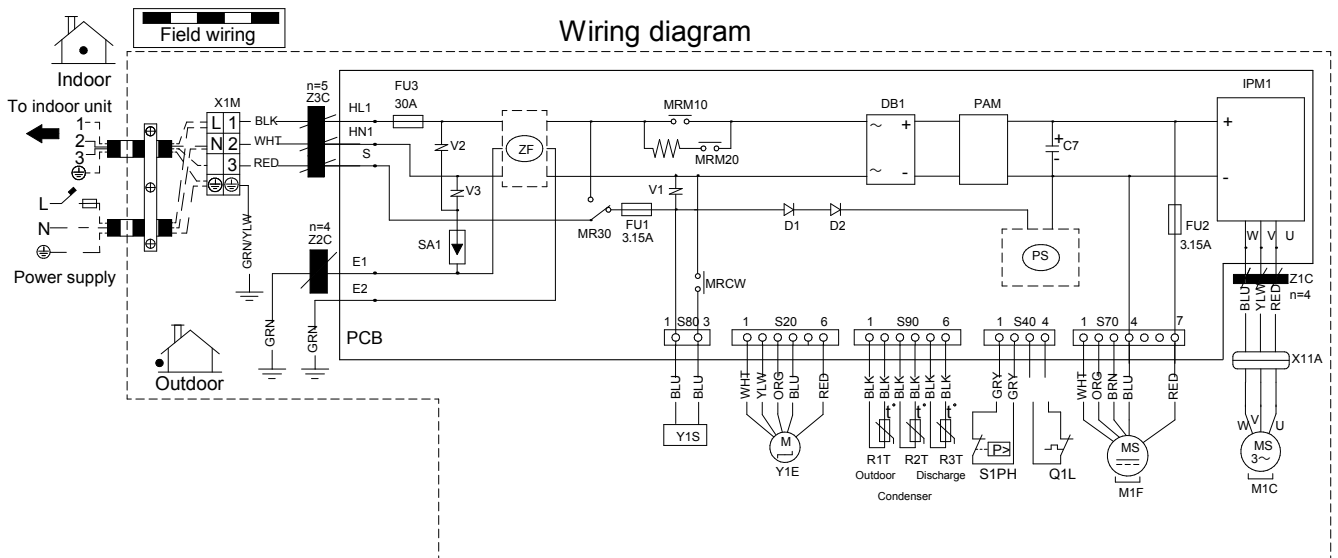

3D130907-1A

7.3 Piping diagram

7.3.1 Piping diagram: Indoor unit

FTXM20R



INFORMATION

The diagrams shown in this manual may be incorrect due to changes/updates to the unit. Correct diagrams are supplied with the unit and can also be found in the technical data book.

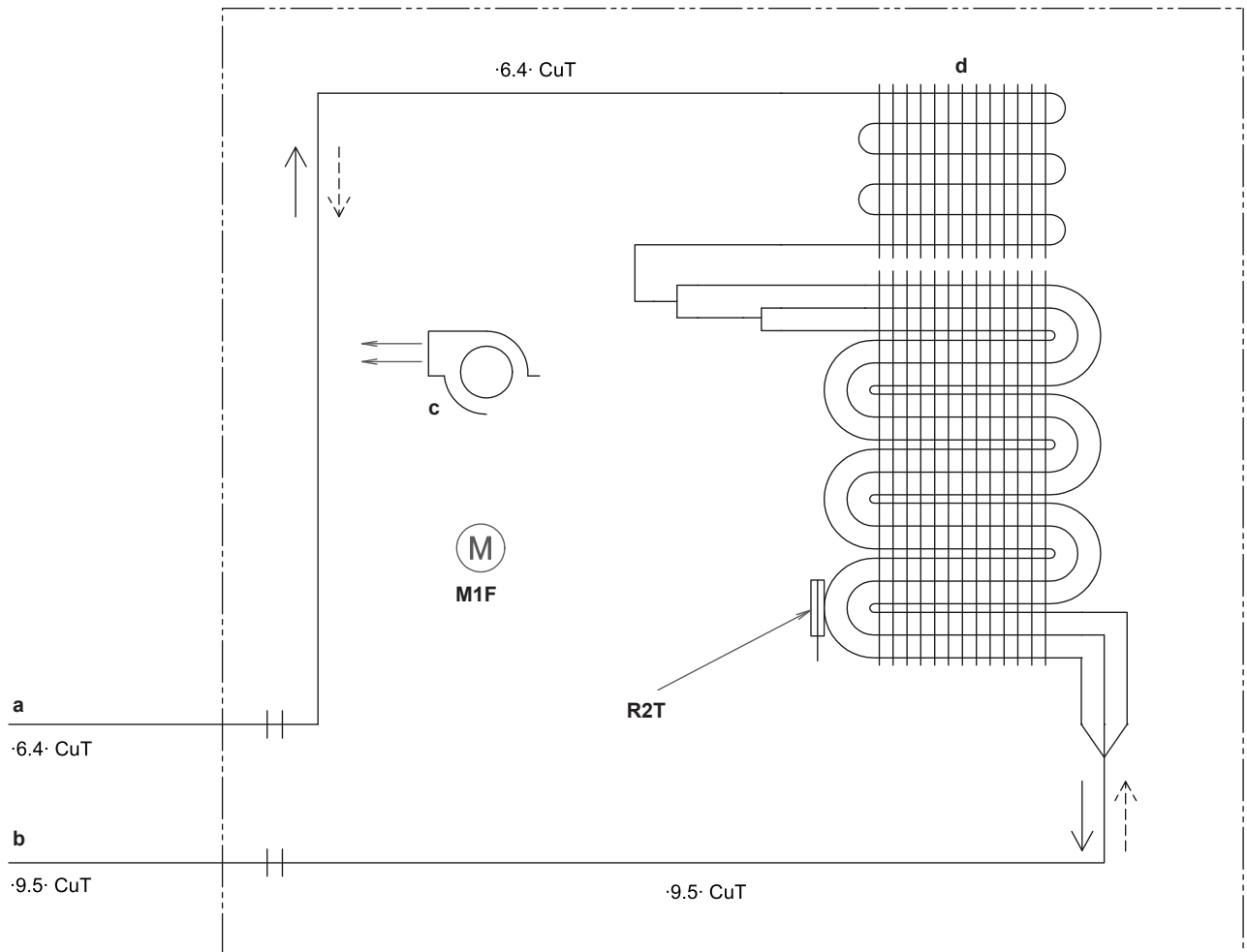

- a** Field piping (liquid: $\varnothing 6.4$ mm flare connection)
- b** Field piping (gas: $\varnothing 9.5$ mm flare connection)
- c** Crossflow fan
- d** Heat exchanger
- M1F** Fan motor
- R2T** Thermistor (heat exchanger)
- > Heating
- > Cooling

FTXM25~42R + ATXM25+35R



INFORMATION

The diagrams shown in this manual may be incorrect due to changes/updates to the unit. Correct diagrams are supplied with the unit and can also be found in the technical data book.

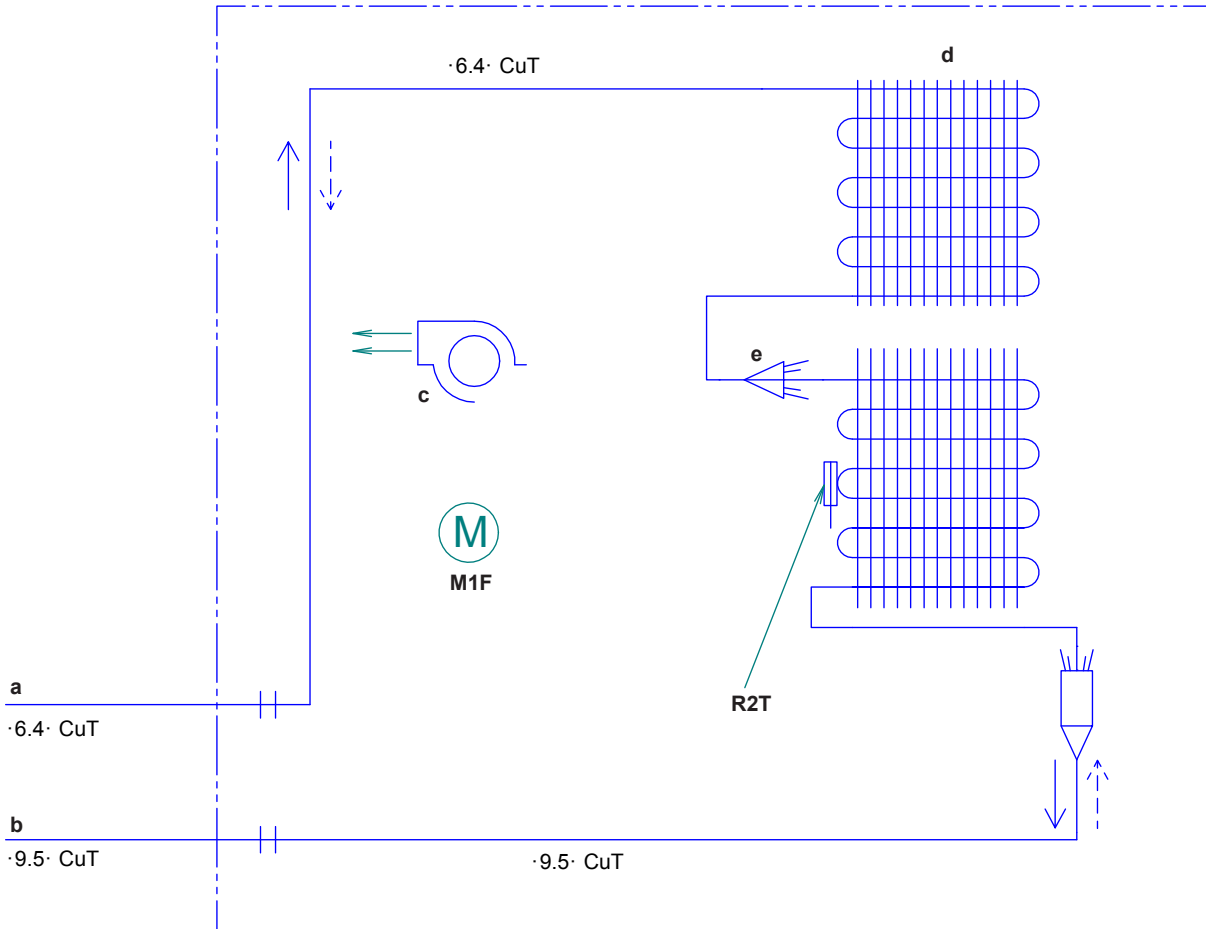

- a** Field piping (liquid: Ø6.4 mm flare connection)
- b** Field piping (gas: Ø9.5 mm flare connection)
- c** Crossflow fan
- d** Heat exchanger
- e** Distributor
- M1F** Fan motor
- R2T** Thermistor (heat exchanger)
- Heating
- Cooling

FTXM50+60R + ATXM50R



INFORMATION

The diagrams shown in this manual may be incorrect due to changes/updates to the unit. Correct diagrams are supplied with the unit and can also be found in the technical data book.

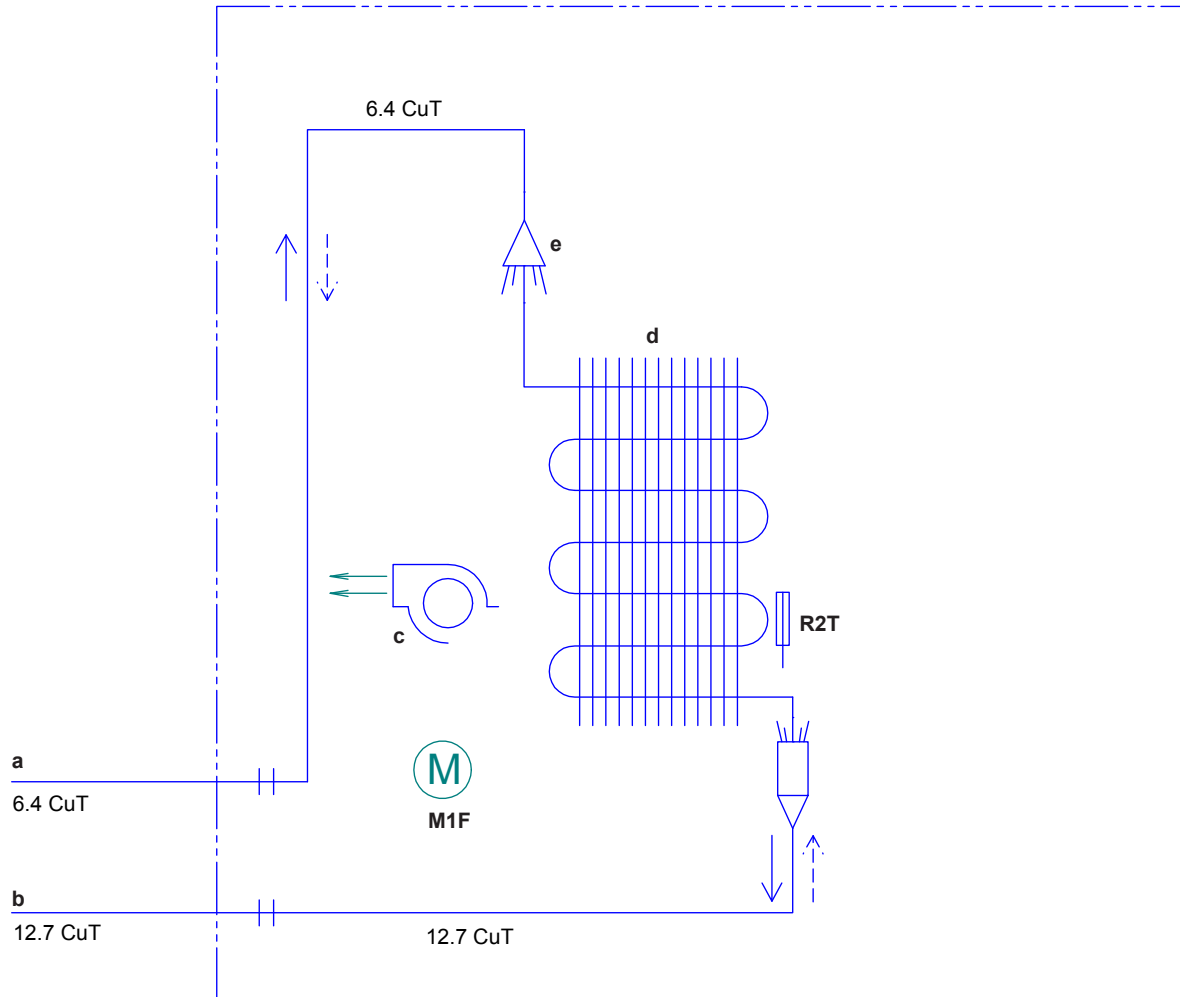

- a** Field piping (liquid: \varnothing 6.4 mm flare connection)
- b** Field piping (gas: \varnothing 12.7 mm flare connection)
- c** Crossflow fan
- d** Heat exchanger
- e** Distributor
- M1F** Fan motor
- R2T** Thermistor (heat exchanger)
- >** Heating
- >** Cooling

FTXM71R



INFORMATION

The diagrams shown in this manual may be incorrect due to changes/updates to the unit. Correct diagrams are supplied with the unit and can also be found in the technical data book.

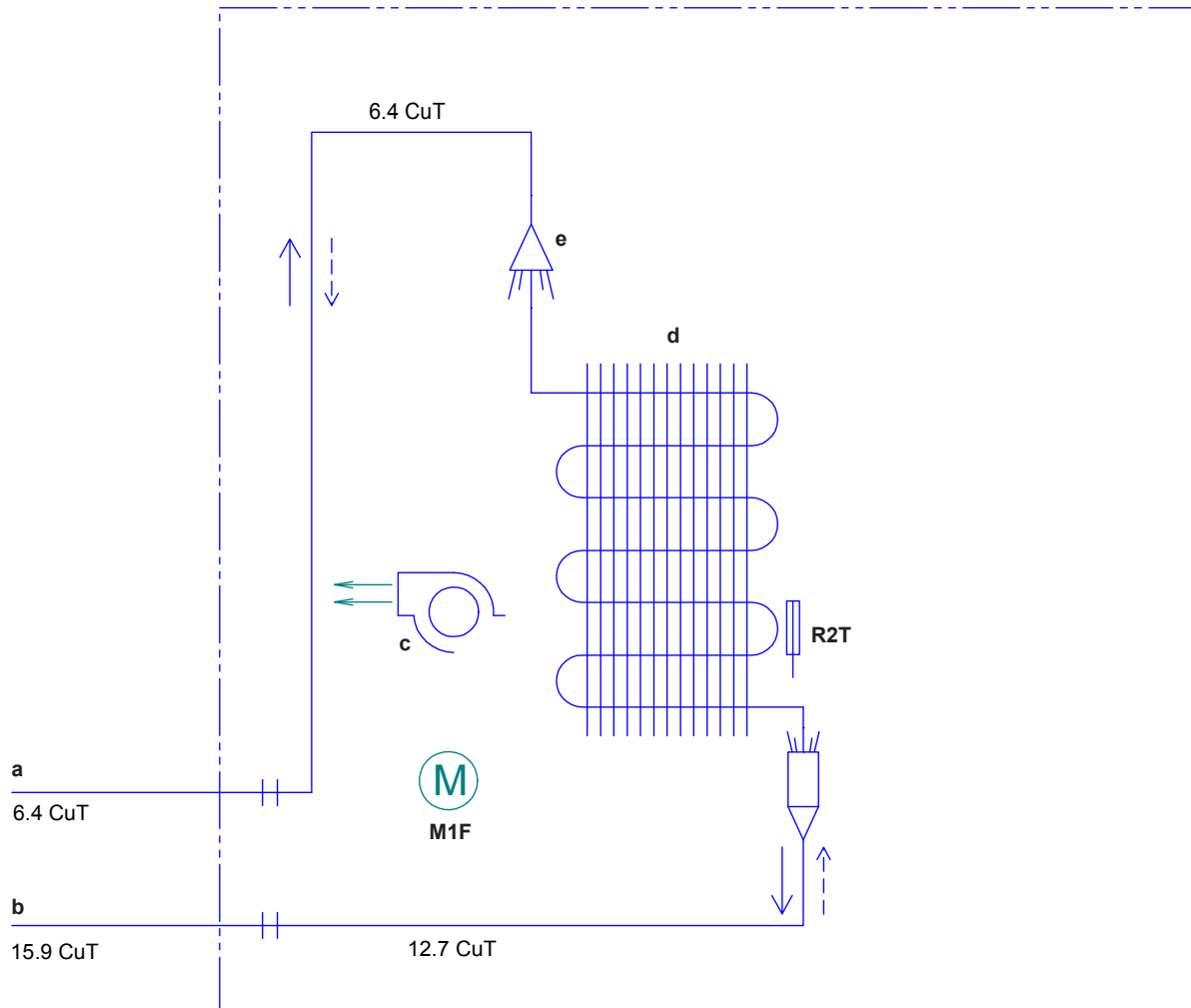

- a** Field piping (liquid: \varnothing 6.4 mm flare connection)
- b** Field piping (gas: \varnothing 15.9 mm flare connection)
- c** Crossflow fan
- d** Heat exchanger
- e** Distributor
- M1F** Fan motor
- R2T** Thermistor (heat exchanger)
- > Heating
- > Cooling

FVXM25+35A



INFORMATION

The diagrams shown in this manual may be incorrect due to changes/updates to the unit. Correct diagrams are supplied with the unit and can also be found in the technical data book.

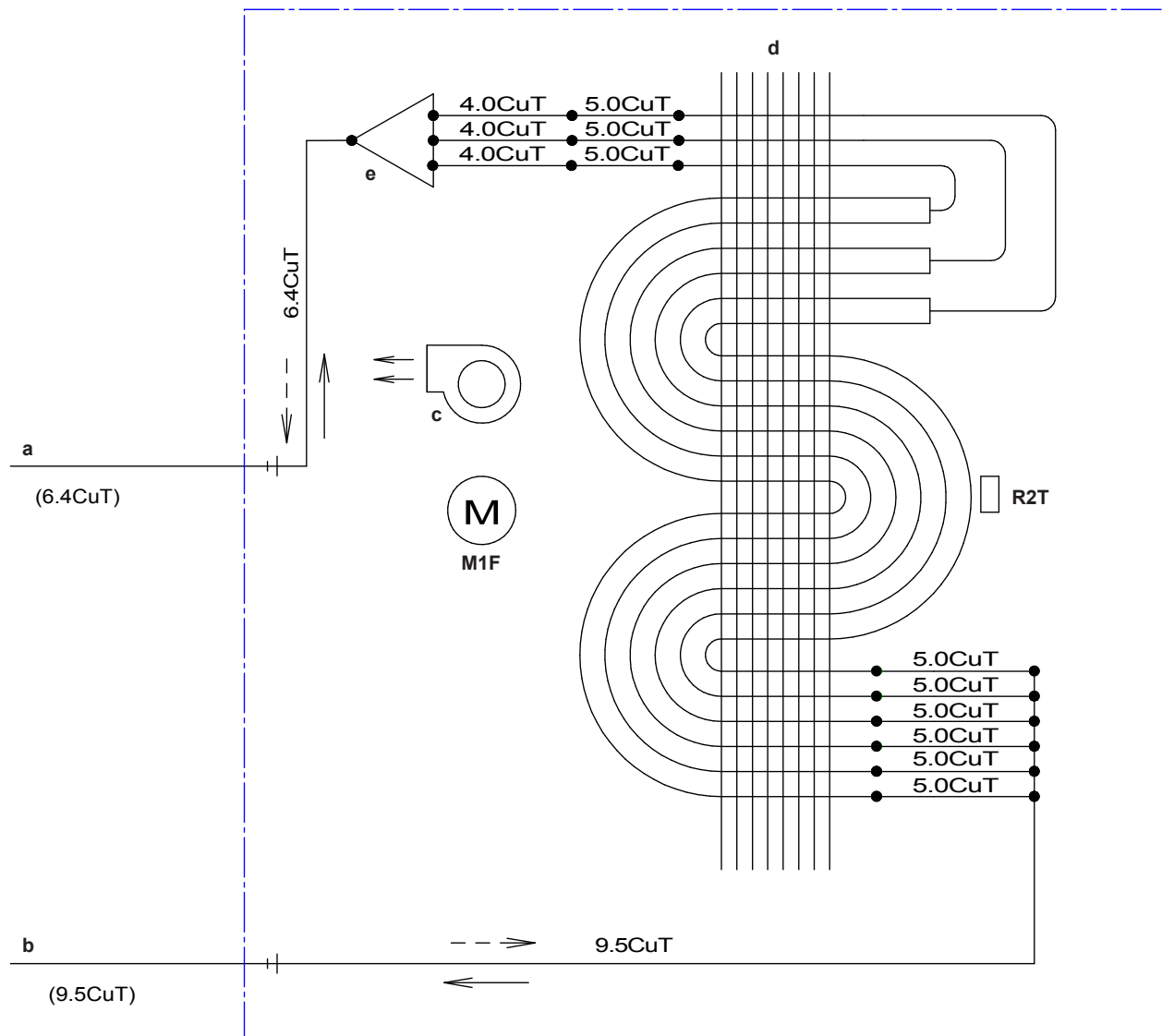

- a** Field piping (liquid: $\varnothing 6.4$ mm flare connection)
- b** Field piping (gas: $\varnothing 9.5$ mm flare connection)
- c** Turbo fan
- d** Heat exchanger
- e** Distributor
- M1F** Fan motor
- R2T** Thermistor (heat exchanger)
- >** Heating
- >** Cooling

FVXM50A



INFORMATION

The diagrams shown in this manual may be incorrect due to changes/updates to the unit. Correct diagrams are supplied with the unit and can also be found in the technical data book.

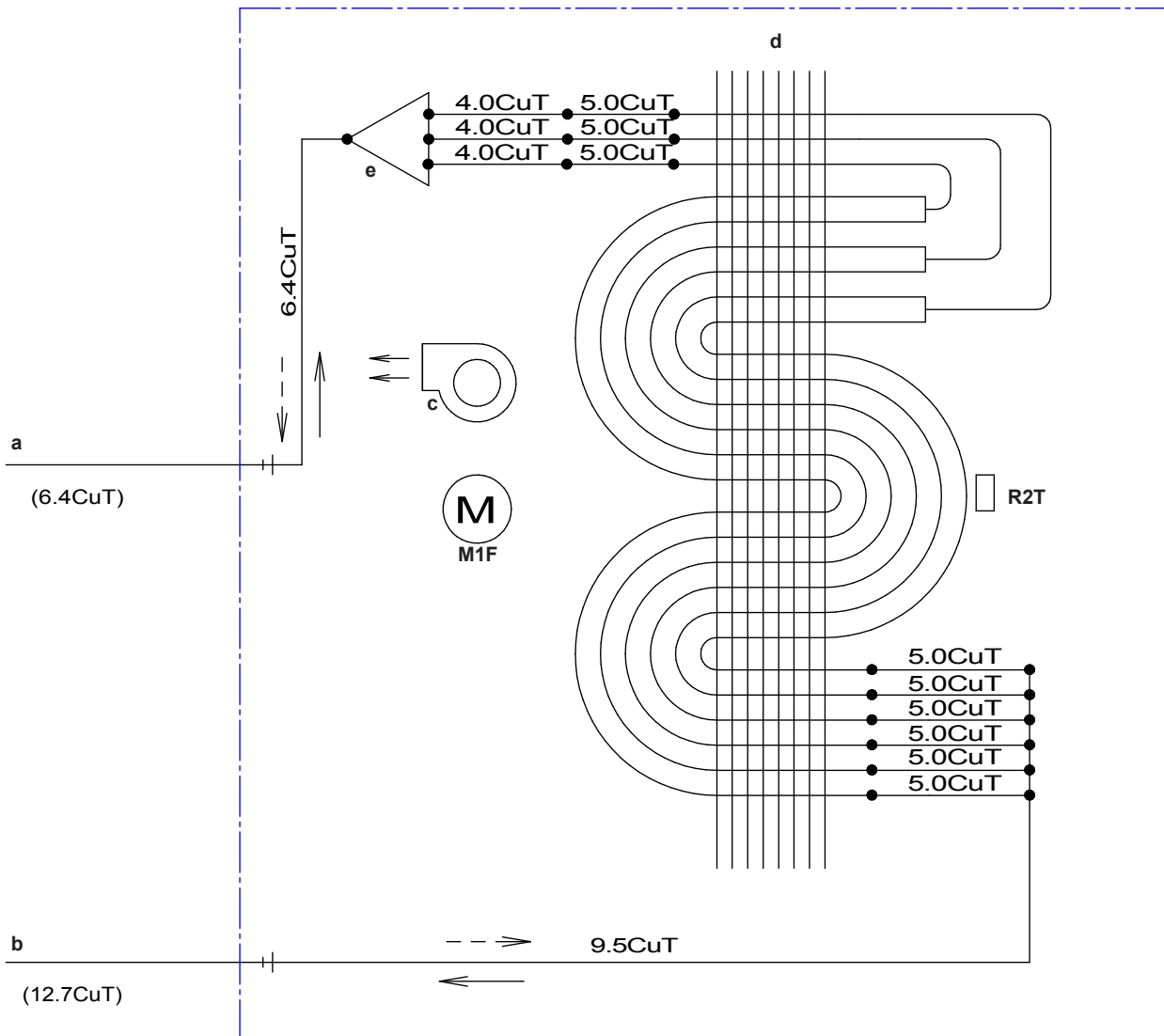

- a** Field piping (liquid: $\varnothing 6.4$ mm flare connection)
- b** Field piping (gas: $\varnothing 12.7$ mm flare connection)
- c** Turbo fan
- d** Heat exchanger
- e** Distributor
- M1F** Fan motor
- R2T** Thermistor (heat exchanger)
- \dashrightarrow Heating
- \rightarrow Cooling

7.3.2 Piping diagram: Outdoor unit

RXM20~35R + ARXM25+35R



INFORMATION

The diagrams shown in this manual may be incorrect due to changes/updates to the unit. Correct diagrams are supplied with the unit and can also be found in the technical data book.

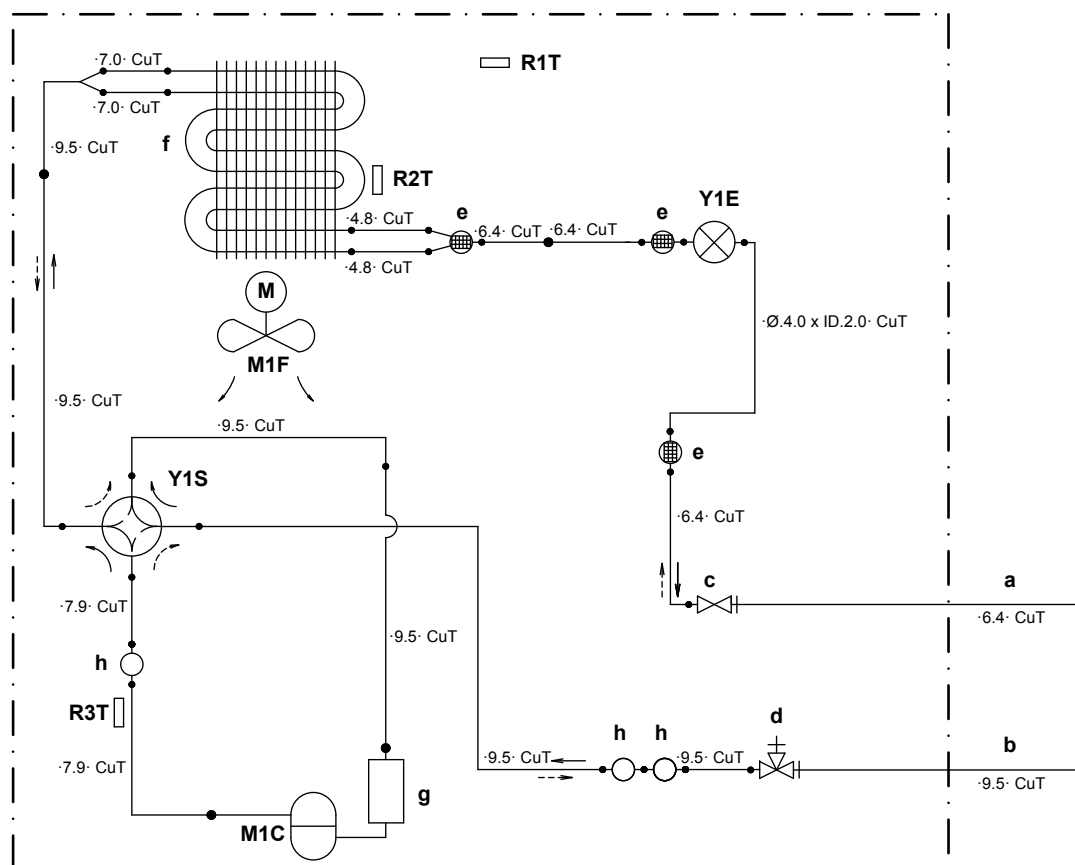

- a** Field piping (liquid: Ø6.4 mm flare connection)
- b** Field piping (gas: Ø9.5 mm flare connection)
- c** Liquid stop valve
- d** Gas stop valve
- e** Muffler with filter
- f** Heat exchanger
- g** Accumulator
- h** Muffler

- M1C** Compressor
- M1F** Fan
- R1T** Thermistor (outdoor air)
- R2T** Thermistor (heat exchanger)
- R3T** Thermistor (discharge pipe)
- Y1E** Electronic expansion valve
- Y1S** 4-way valve (ON: heating)
- Refrigerant flow: cooling
- - - Refrigerant flow: heating

RXM42R



INFORMATION

The diagrams shown in this manual may be incorrect due to changes/updates to the unit. Correct diagrams are supplied with the unit and can also be found in the technical data book.

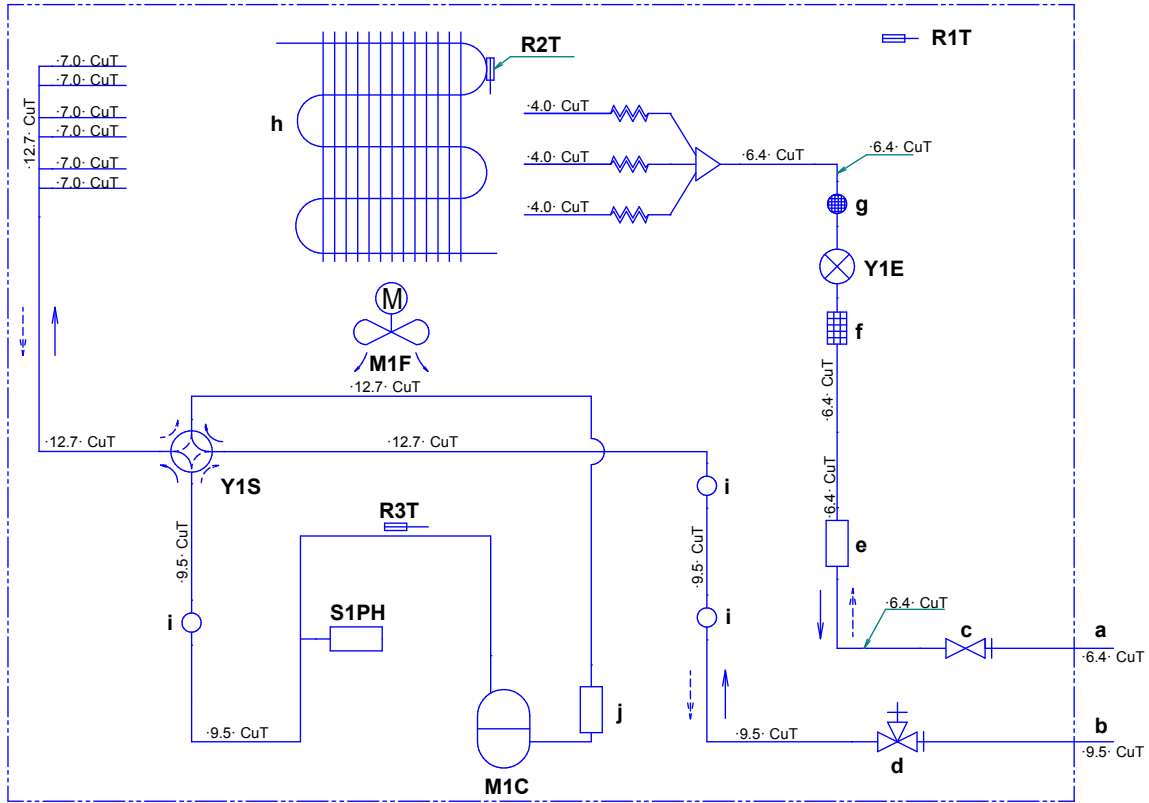

- a** Field piping (liquid: Ø6.4 mm flare connection)
- b** Field piping (gas: Ø9.5 mm flare connection)
- c** Liquid stop valve
- d** Gas stop valve
- e** Liquid receiver
- f** Filter
- g** Muffler with filter
- h** Heat exchanger
- i** Muffler
- j** Accumulator

- M1C** Compressor
- M1F** Fan
- R1T** Thermistor (outdoor air)
- R2T** Thermistor (heat exchanger)
- R3T** Thermistor (discharge pipe)
- S1PH** High pressure switch
- Y1E** Electronic expansion valve
- Y1S** 4-way valve (ON: heating)
- Refrigerant flow: cooling
- - - - - Refrigerant flow: heating

RXM50+60R + ARXM50+60R



INFORMATION

The diagrams shown in this manual may be incorrect due to changes/updates to the unit. Correct diagrams are supplied with the unit and can also be found in the technical data book.

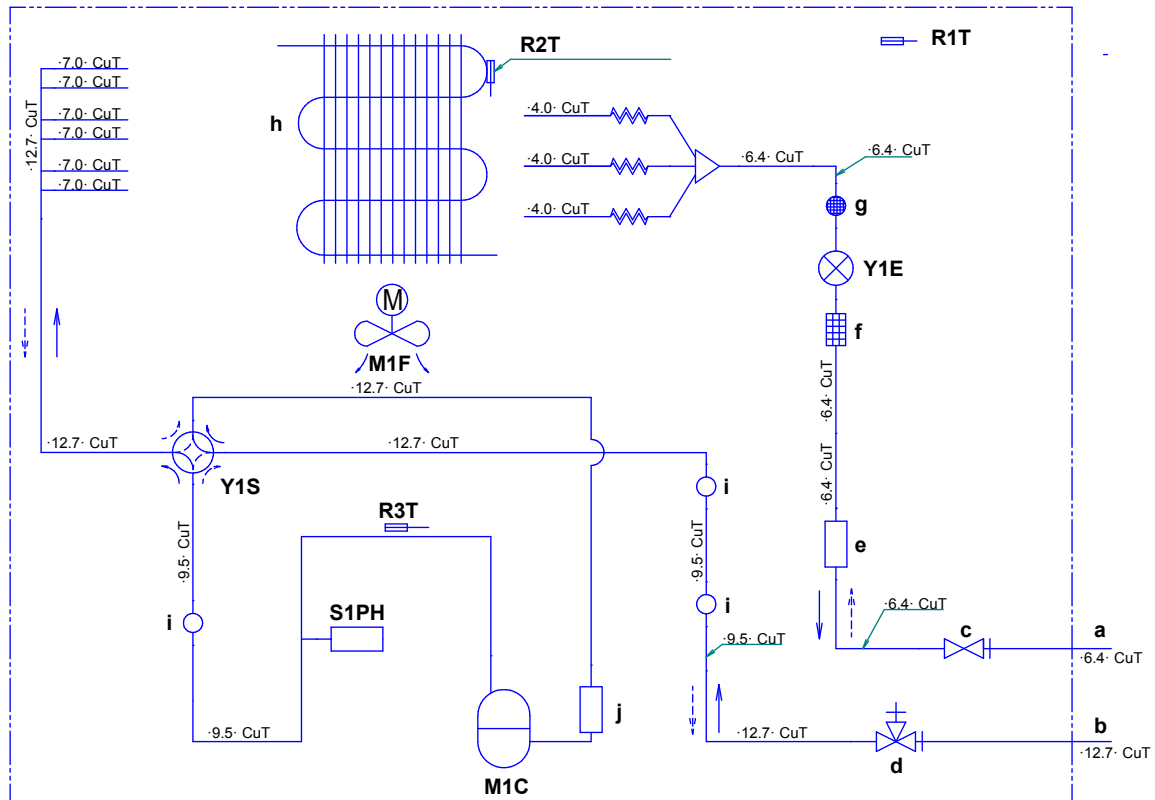

- a** Field piping (liquid: \varnothing 6.4 mm flare connection)
- b** Field piping (gas: \varnothing 12.7 mm flare connection)
- c** Liquid stop valve
- d** Gas stop valve
- e** Liquid receiver
- f** Filter
- g** Muffler with filter
- h** Heat exchanger
- i** Muffler
- j** Accumulator

- M1C** Compressor
- M1F** Fan
- R1T** Thermistor (outdoor air)
- R2T** Thermistor (heat exchanger)
- R3T** Thermistor (discharge pipe)
- S1PH** High pressure switch
- Y1E** Electronic expansion valve
- Y1S** 4-way valve (ON: heating)
- Refrigerant flow: cooling
- - - -> Refrigerant flow: heating

RXM71R + ARXM71R



INFORMATION

The diagrams shown in this manual may be incorrect due to changes/updates to the unit. Correct diagrams are supplied with the unit and can also be found in the technical data book.

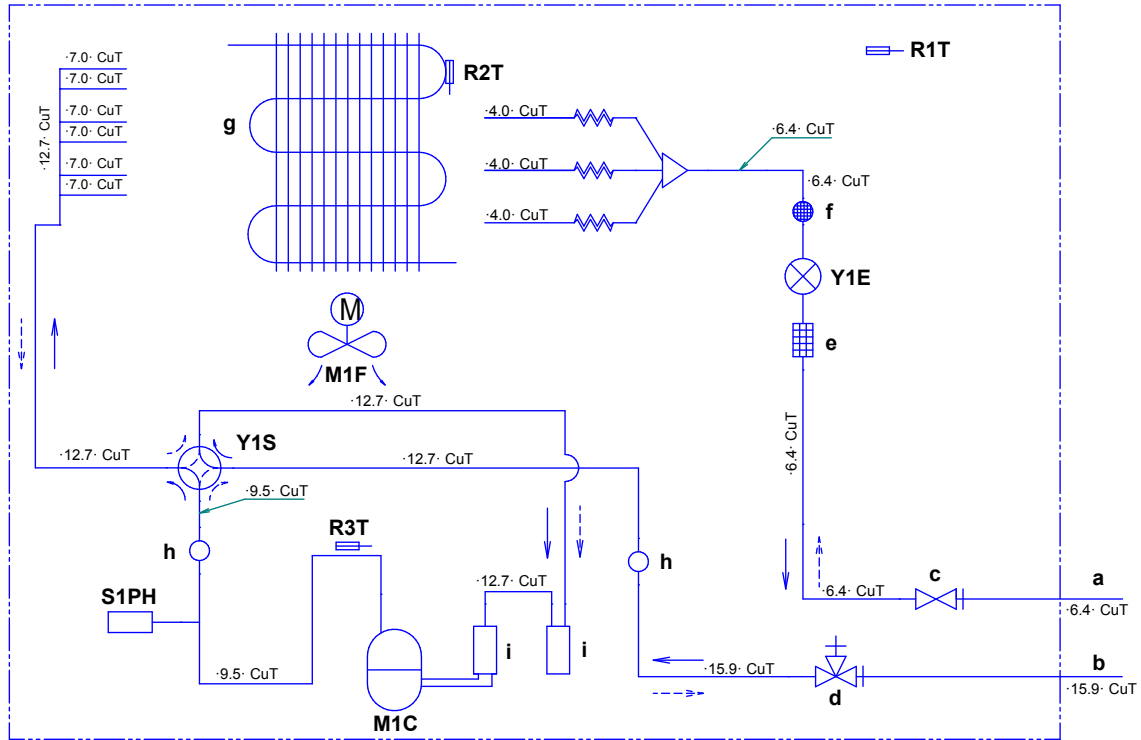

- a** Field piping (liquid: Ø6.4 mm flare connection)
- b** Field piping (gas: Ø15.9 mm flare connection)
- c** Liquid stop valve
- d** Gas stop valve
- e** Filter
- f** Muffler with filter
- g** Heat exchanger
- h** Muffler
- i** Accumulator

- M1C** Compressor
- M1F** Fan
- R1T** Thermistor (outdoor air)
- R2T** Thermistor (heat exchanger)
- R3T** Thermistor (discharge pipe)
- S1PH** High pressure switch
- Y1E** Electronic expansion valve
- Y1S** 4-way valve (ON: heating)
- Refrigerant flow: cooling
- - - → Refrigerant flow: heating

7.4 Component overview

7.4.1 Component overview: Outdoor unit

RXM20~35R + ARXM25+35R

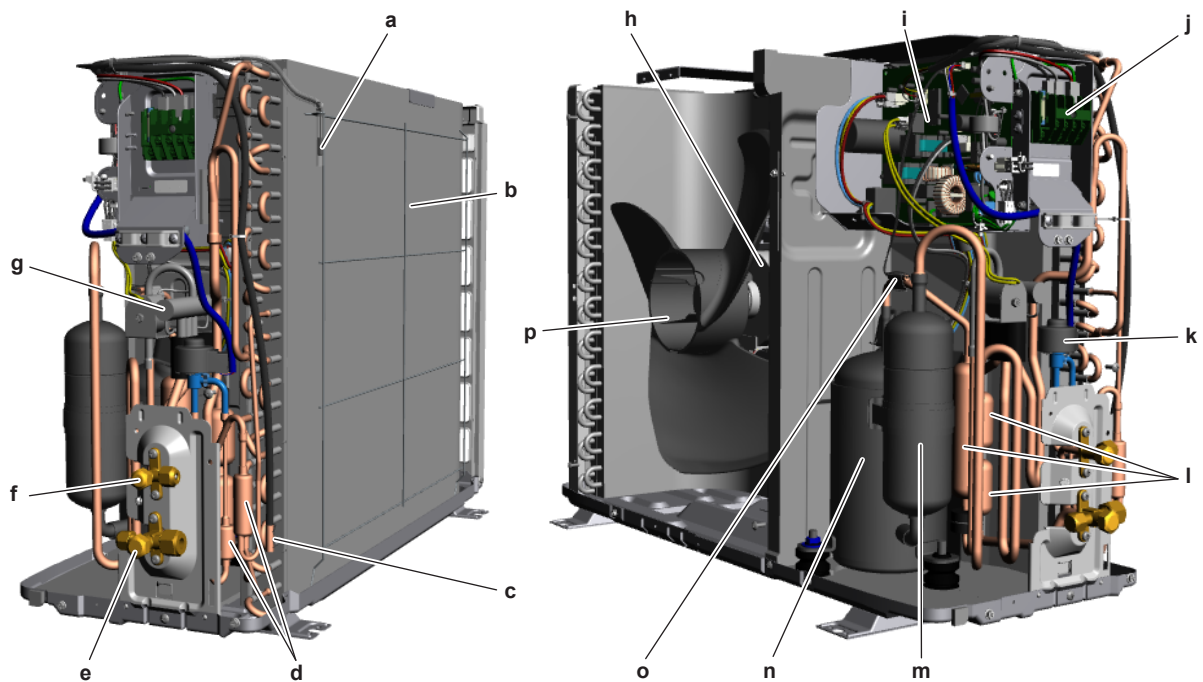

- a** Air thermistor R1T
- b** Heat exchanger
- c** Heat exchanger thermistor R2T
- d** Muffler with filter
- e** Stop valve with service port (gas)
- f** Stop valve (liquid)
- g** 4-way valve Y1S
- h** Fan motor M1F

- i** Main PCB A1P
- j** Power supply terminal X1M
- k** Expansion valve Y1E
- l** Muffler
- m** Accumulator
- n** Compressor M1C
- o** Discharge pipe thermistor R3T
- p** Fan

RXM42~71R + ARXM50~71R

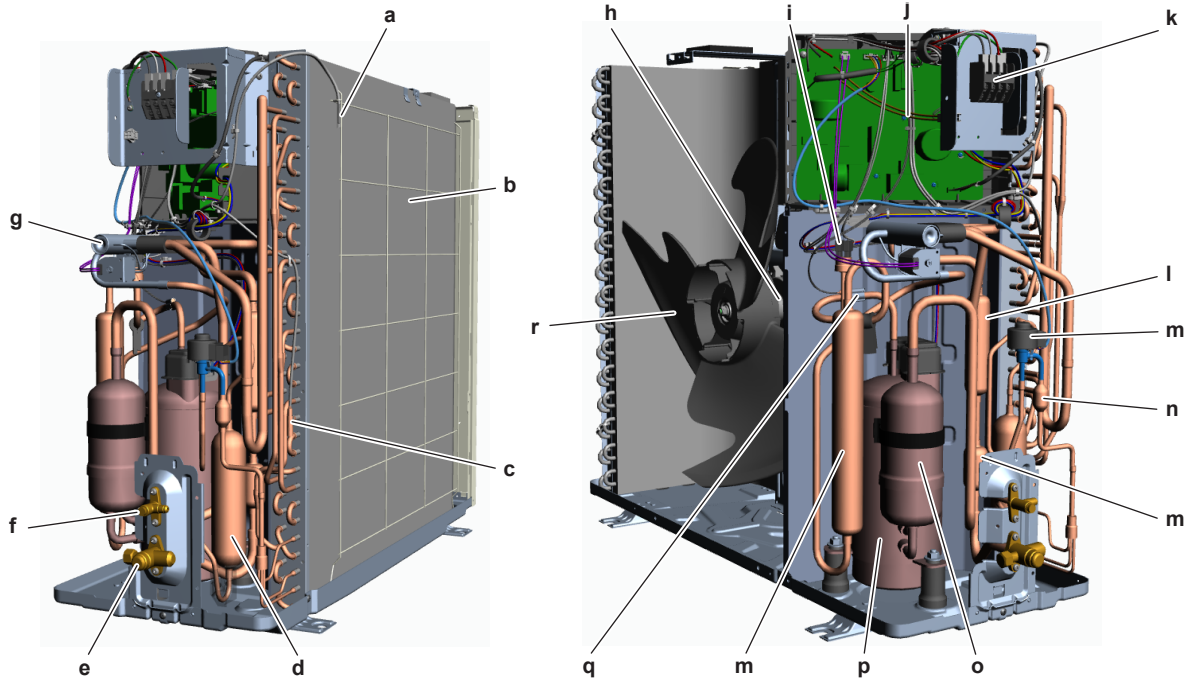

- a Air thermistor R1T
- b Heat exchanger
- c Heat exchanger thermistor R2T
- d Liquid receiver
- e Stop valve with service port (gas)
- f Stop valve (liquid)
- g 4-way valve Y1S

- h Fan motor M1F
- i High pressure switch S1PH
- j Main PCB A1P
- k Power supply terminal X1M
- l Muffler
- m Expansion valve Y1E
- n Muffler with filter
- o Accumulator
- p Compressor M1C
- q Discharge pipe thermistor R3T
- r Fan

7.4.2 Component overview: Wall mounted indoor unit

FTXM20~42R + ATXM25+35R

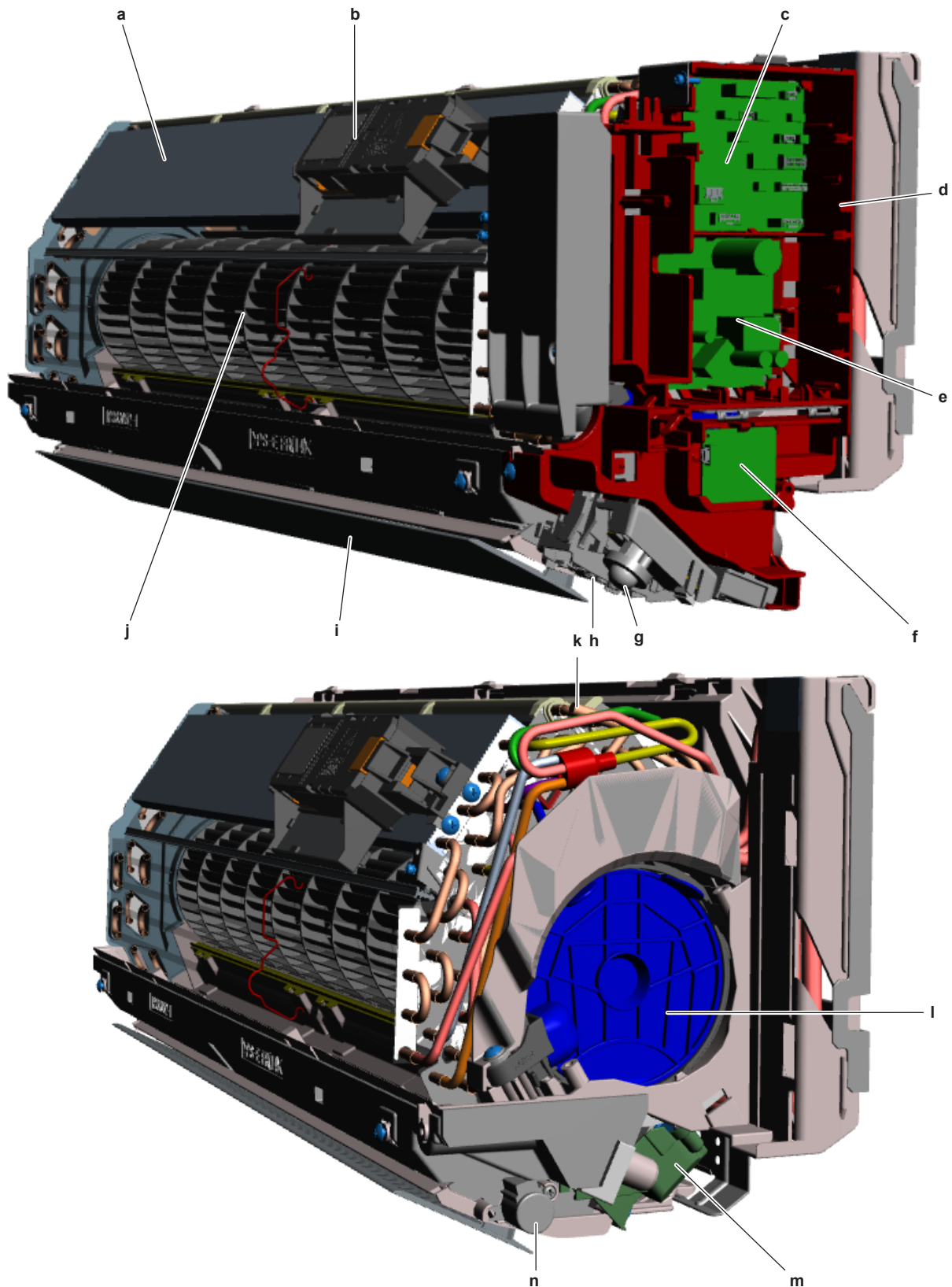

- a** Heat exchanger
- b** Streamer unit
- c** Indoor unit main PCB A1P
- d** Switch box
- e** Indoor unit power PCB A2P
- f** Wifi control PCB A6P
- g** Intelligent eye sensor (PCB A5P)

- h** Display PCB A3P
- i** Swing flap
- j** Fan
- k** Heat exchanger thermistor R2T
- l** Indoor unit fan motor M1F
- m** Swing raster motor M1S
- n** Swing flap motor M2S

FTXM50~71R + ATXM50R

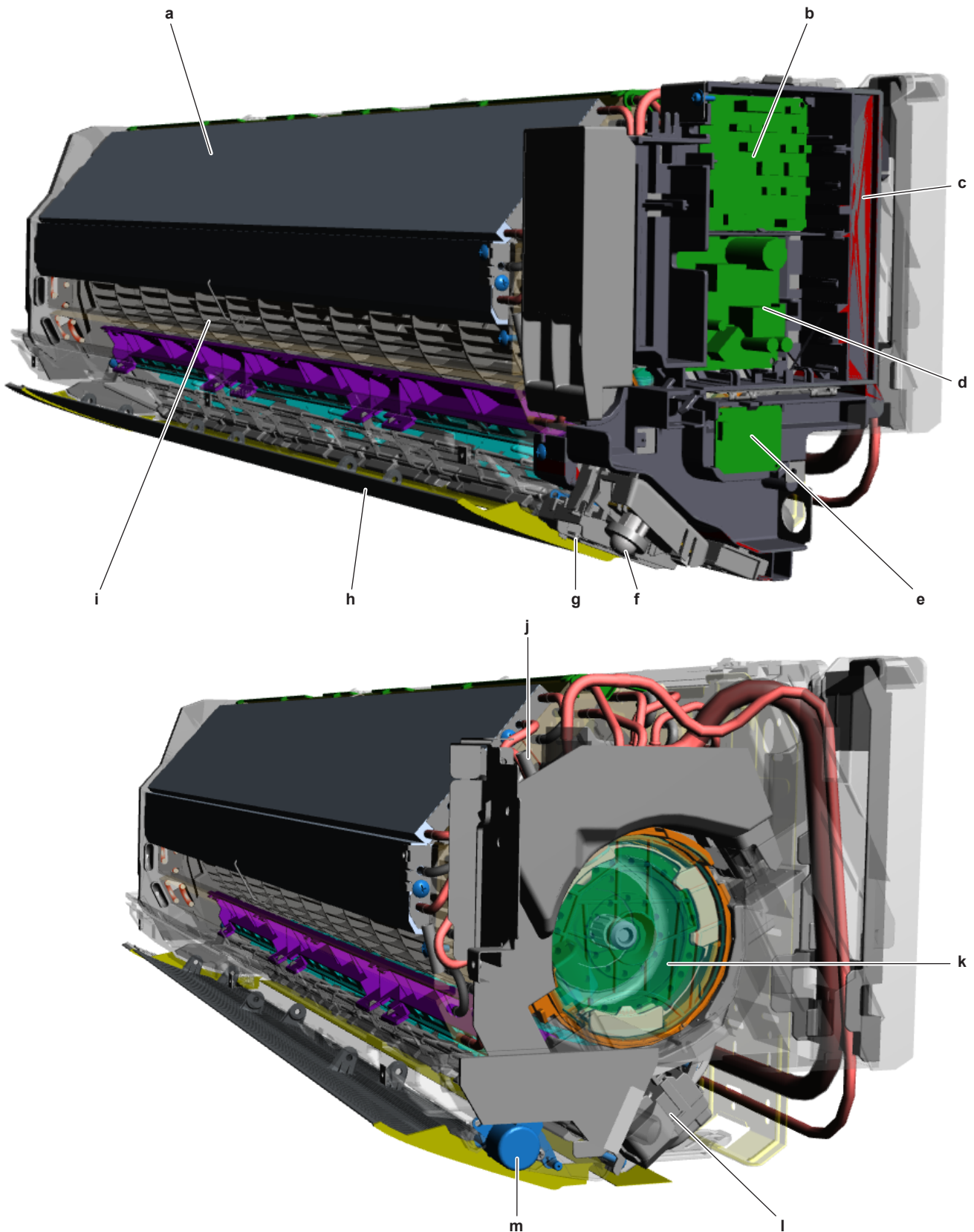

- a** Heat exchanger
- b** Indoor unit main PCB A1P
- c** Switch box
- d** Indoor unit power PCB A2P
- e** Wifi control PCB A6P
- f** Intelligent eye sensor (PCB A5P)
- g** Display PCB A3P

- h** Swing flap
- i** Fan
- j** Heat exchanger thermistor R2T
- k** Indoor unit fan motor M1F
- l** Swing raster motor M1S
- m** Swing flap motor M2S

7.4.3 Component overview: Floor standing indoor unit

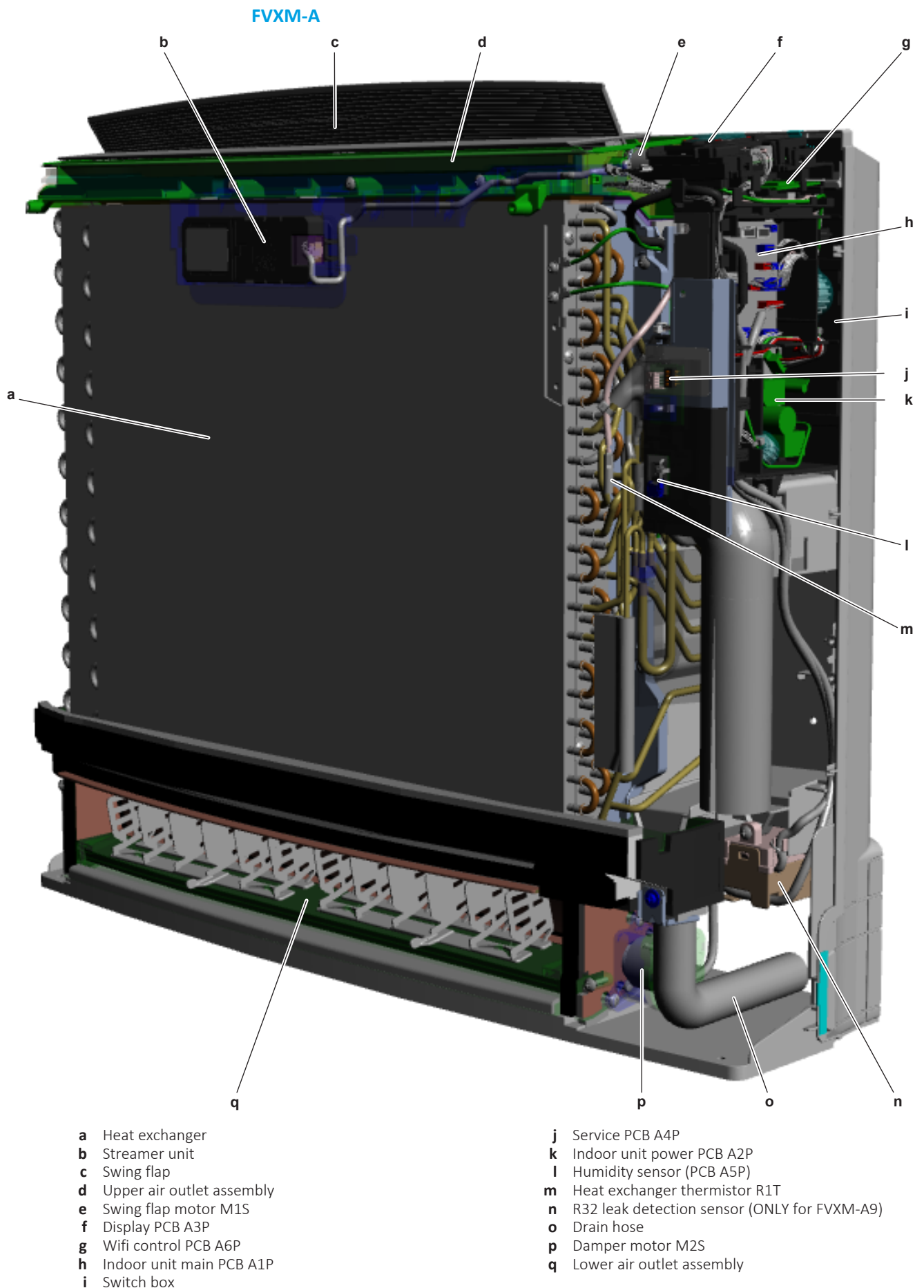

7.5 Field information report

See next page.

In case a problem occurred on the unit which could not be resolved by using the content of this service manual or in case you have a problem which could be resolved but of which the manufacturer should be notified, we advise you to contact your distributor.

To facilitate the investigation, additional information is required. Please fill out the following form before contacting your distributor.

FIELD INFORMATION REPORT	
Key person information	
Name:	Company name:
Your contact details	
Phone number:	E-mail address:
Site address:	
Your reference:	Date of visit:
Claim information	
Title:	
Problem description:	
Error code:	Trouble date:
Problem frequency:	
Investigation steps done:	
Insert picture of the trouble.	
Current situation (solved, not solved,...):	
Countermeasures taken:	
Comments and proposals:	
Part available for return (if applicable):	

Application information

Application (house, apartment, office,...):

New project or reimbursement:

Heat emitters (radiators / under floor heating / fan coils /...):

Hydraulic layout (simple schematic):

Unit / Installation information

Model name:

Serial number:

Installation / commissioning date:

Software version hydro PCB A1P

Software version hydro PCB A5P

Software version user interface:

Software version outdoor PCB:

Minimum water volume:

Maximum water volume:

Brine composition and mixture:

Brine freeze up temperature:

Space heating control (leaving water temperature, room thermostat, external room thermostat):

Space heating setpoint:

Domestic hot water control (reheat only, schedule only, reheat + schedule):

Domestic hot water setpoint:

Provide pictures of the field settings overview (viewable on the user interface).

7.6 Service tools

- 1 For an overview of the available service tools, check the Daikin Business Portal (authentication required).
- 2 Go to the tab After-sales support on the left navigation pane and select Technical support.

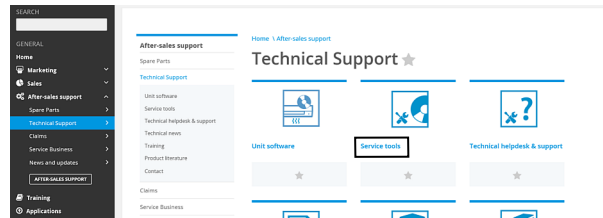









- 3 Click the button Service tools. An overview of the available service tools for the different products is shown. Also additional information on the service tools (instruction, latest software) can be found here.

7.7 Field settings

7.7.1 To control heating only mode

Prerequisite: Stop operation of the unit.

- 1 Press , , and  simultaneously.
- 2 Press .
- 3 Select SU.
- 4 Press  to confirm.
- 5 Press .
- 6 Select 19.
- 7 Press  to confirm.
- 8 Press .
- 9 Select 1 (0: factory setting, 1: heating only).
- 10 Press  to confirm.

7.7.2 To adjust target set temperature in heating operation



INFORMATION









When there is a big difference between the indoor room temperature and the set temperature in heating mode, adjust the target set temperature field setting.

Example for wall mounted units:

- Target temperature = remote controller set temperature + 2.5°C.
Remote controller set temperature = 20°C
Target temperature = 20°C + 2.5°C = 22.5°C
Thermo off temperature = 24.5°C









Example for floor standing units:

- Target temperature = remote controller set temperature + 2°C.
Remote controller set temperature = 20°C
Target temperature = 20°C + 2°C = 22°C
Thermo off temperature = 24°C





- 1 Press , , and  simultaneously.
- 2 Press .
- 3 Select SU.
- 4 Press  to confirm.
- 5 Press .
- 6 Select 7.
- 7 Press  to confirm.
- 8 Press .
- 9 Select the value to set the desired target temperature:
 - 0 = -2,0°C
 - 1 = -1,0°C
 - 2 = 0°C (factory setting)
 - 3 = +1,0°C
 - 4 = +2,0°C
- 10 Press  to confirm.

7.7.3 To control the indoor unit fan during thermostat off in cooling

Wall mounted units

- 1 Press , , and  simultaneously.
- 2 Press .
- 3 Select SU.
- 4 Press  to confirm.
- 5 Press .
- 6 Select 4.
- 7 Press  to confirm.
- 8 Press .
- 9 Select 0 (0: fan ON, 1: fan OFF (factory setting)).
- 10 Press  to confirm.

Floor standing units

- 1 On the home screen, press  for at least 2 seconds.
Result: The selection menu number **3** appears on the display. **3** is blinking.
- 2 Press  to enter the setting.
- 3 Press  or  to change the setting to ON or OFF (factory setting).

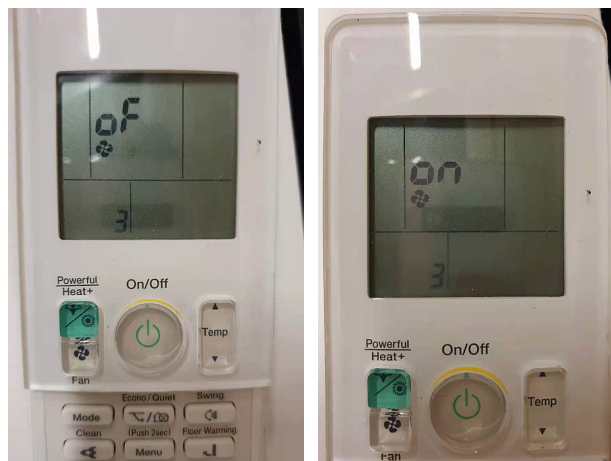

- 4 Press  to confirm the selected setting.

Note: The display automatically returns to the default screen after 60 seconds. To return to the default screen sooner, press  twice.

7.7.4 To change auto restart ON to OFF

**INFORMATION**

After power failure, the unit will automatically restart (default setting). It is possible to switch OFF auto restart. For example: after a long power failure, generators have to start-up. As there is limited energy and the air conditioners do NOT have priority, it is recommended to switch OFF auto restart.

- 1 Press , , and simultaneously.
- 2 Press .
- 3 Select SU.
- 4 Press to confirm.
- 5 Press .
- 6 Select 10.
- 7 Press to confirm.
- 8 Press .
- 9 Select 0 (0: auto restart OFF, 1: auto restart ON (factory setting)).
- 10 Press to confirm.

7.7.5 To limit the angle of the upper swing flap

For embedded floor standing units, it may be needed to reduce the maximum angle of the upper swing flap to avoid collision. To do this, perform as described below.

Prerequisite: Remove the front panel and the front grille to get access to the service PCB.

- 1 Set the DIP switch DS1-1 to the ON position.

Result: The maximum angle of the upper swing flap is now reduced.

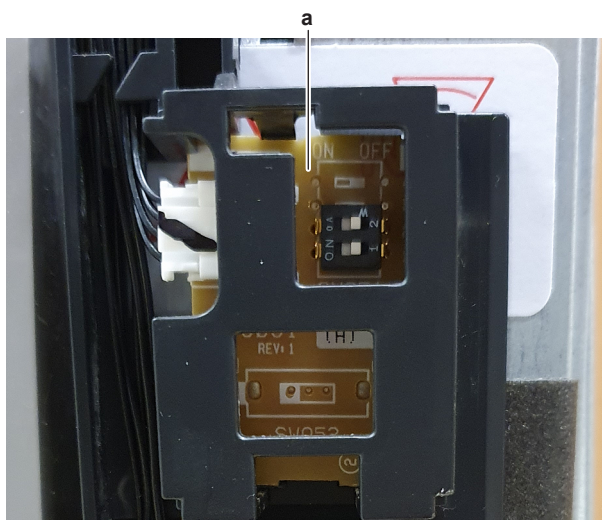

- a Service PCB
ON ON
OFF OFF

7.7.6 To reduce maximum sound levels

**INFORMATION**

ONLY applicable for RXM-R9 and ARXM-R9 units.

If the sound level CANNOT meet the local regulation (e.g. Netherlands), the maximum sound level can be reduced by cutting J5 jumper on the main PCB of the outdoor unit.

Prerequisite: Stop the unit operation via the user interface.

Prerequisite: Turn OFF the respective circuit breaker.

Prerequisite: Remove the required plate work, see "4.14 Plate work" [▶ 157].

- 1 Cut the J5 jumper on the main PCB of the outdoor unit.

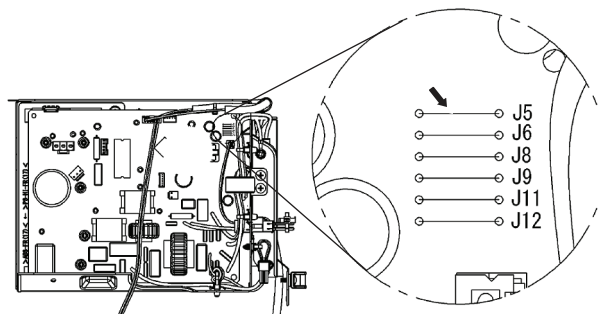

Field setting	Sound level reduction	To be used at ...
Cut J5 jumper	1 dB	Day
J5 jumper + ECONO mode activated via remote controller	2 dB ^(a)	Night

^(a) If this field setting is done, the maximum sound level will be 2 dB lower than the maximum sound level during normal night operation (unit without this field setting and with outdoor unit quiet operation activated). So when this field setting is done on the unit, it is NOT needed to activate the outdoor unit quiet operation to meet the local regulation.

**INFORMATION**

New setting may affect the performance of the unit.





DAIKIN EUROPE N.V.

Zandvoordestraat 300, B-8400 Oostende, Belgium

Copyright 2021 Daikin

ESIE20-11C 2023.02