

Revision A:

- MSZ-EF18/22/25/35/42/50VGW/B/S - **E2**,
MSZ-EF22/25/35/42/50VGW/B/S - **ET2**,
MSZ-EF18/22/25/35/42/50VGKW/B/S - **E1** and
MSZ-EF22/25/35/42/50VGKW/B/S - **ET1**
have been added.

OBH831 is void.

INDOOR UNIT SERVICE MANUAL

No. OBH831
REVISED EDITION-A

Models

MSZ-EF18VGW/B/S - E1 , E2	MSZ-EF18VGKW/B/S - E1
MSZ-EF22VGW/B/S - E1 , ET1 , E2 , ET2	MSZ-EF22VGKW/B/S - E1 , ET1
MSZ-EF25VGW/B/S - E1 , ET1 , E2 , ET2	MSZ-EF25VGKW/B/S - E1 , ET1
MSZ-EF35VGW/B/S - E1 , ET1 , E2 , ET2	MSZ-EF35VGKW/B/S - E1 , ET1
MSZ-EF42VGW/B/S - E1 , ET1 , E2 , ET2	MSZ-EF42VGKW/B/S - E1 , ET1
MSZ-EF50VGW/B/S - E1 , ET1 , E2 , ET2	MSZ-EF50VGKW/B/S - E1 , ET1

Outdoor unit service manual
MUZ-EF-VG/H Series (OBH832)
MXZ-F-VF Series(OBH790)

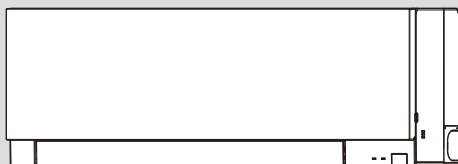

MSZ-EF-VGW/VGKW
MSZ-EF-VGB/VGKB
MSZ-EF-VGS/VGKS



CONTENTS

1. TECHNICAL CHANGES	3
2. PART NAMES AND FUNCTIONS.....	4
3. SPECIFICATION.....	5
4. NOISE CRITERIA CURVES	7
5. OUTLINES AND DIMENSIONS	9
6. WIRING DIAGRAM.....	10
7. REFRIGERANT SYSTEM DIAGRAM	15
8. SERVICE FUNCTIONS	16
9. MICROPROCESSOR CONTROL	19
10. TROUBLESHOOTING.....	27
11. DISASSEMBLY INSTRUCTIONS.....	44

PARTS CATALOG (OBB831)

Revision A:

- MSZ-EF18/22/25/35/42/50VGW/B/S - **E2**, MSZ-EF22/25/35/42/50VGW/B/S - **ET2**, MSZ-EF18/22/25/35/42/50VGKW/B/S - **E1** and MSZ-EF22/25/35/42/50VGKW/B/S - **ET1** have been added.

Use the specified refrigerant only**Never use any refrigerant other than that specified.**

Doing so may cause a burst, an explosion, or fire when the unit is being used, serviced, or disposed of.

Correct refrigerant is specified in the manuals and on the spec labels provided with our products.

We will not be held responsible for mechanical failure, system malfunction, unit breakdown or accidents caused by failure to follow the instructions.

<Preparation before the repair service>

- Prepare the proper tools.
- Prepare the proper protectors.
- Provide adequate ventilation.
- After stopping the operation of the air conditioner, turn off the power-supply breaker and remove the power plug.
- Discharge the capacitor before the work involving the electric parts.

<Precautions during the repair service>

- Do not perform the work involving the electric parts with wet hands.
- Do not pour water into the electric parts.
- Do not touch the refrigerant.
- Do not touch the hot or cold areas in the refrigeration cycle.
- When the repair or the inspection of the circuit needs to be done without turning off the power, exercise great caution not to touch the live parts.

1

TECHNICAL CHANGES

The following models are compatible with the outdoor units with low standby power control.

Connecting the following models to the **MUZ-EF-VG/H** series outdoor units enables the low standby power control.

The following models may be connected to the **MUZ-EF-VG/H** series after once connected to the **MXZ series** and operated, for example because of relocation. In that case, the **MUZ-EF-VG/H** series outdoor units will not operate without taking a step. Follow the procedure "Deleting the memorized abnormal condition" described in 10-2.1.

MSZ-EF18VGW/B/S - **E1**

MSZ-EF22VGW/B/S - **E1**, - **ET1**

MSZ-EF25VGW/B/S - **E1**, - **ET1**

MSZ-EF35VGW/B/S - **E1**, - **ET1**

MSZ-EF42VGW/B/S - **E1**, - **ET1**

MSZ-EF50VGW/B/S - **E1**, - **ET1**

MSZ-EF18VGKW/B/S - **E1**

MSZ-EF22VGKW/B/S - **E1**, - **ET1**

MSZ-EF25VGKW/B/S - **E1**, - **ET1**

MSZ-EF35VGKW/B/S - **E1**, - **ET1**

MSZ-EF42VGKW/B/S - **E1**, - **ET1**

MSZ-EF50VGKW/B/S - **E1**, - **ET1**

1. New model

MSZ-EF18VGW/B/S - **E1** → **MSZ-EF18VGW/B/S** - **E2**

MSZ-EF22VGW/B/S - **E1**, - **ET1** → **MSZ-EF22VGW/B/S** - **E2**, - **ET2**

MSZ-EF25VGW/B/S - **E1**, - **ET1** → **MSZ-EF25VGW/B/S** - **E2**, - **ET2**

MSZ-EF35VGW/B/S - **E1**, - **ET1** → **MSZ-EF35VGW/B/S** - **E2**, - **ET2**

MSZ-EF42VGW/B/S - **E1**, - **ET1** → **MSZ-EF42VGW/B/S** - **E2**, - **ET2**

MSZ-EF50VGW/B/S - **E1**, - **ET1** → **MSZ-EF50VGW/B/S** - **E2**, - **ET2**

1. Indoor electronic control P.C. board has been changed.

2

PART NAMES AND FUNCTIONS

MSZ-EF18VGW MSZ-EF22VGW MSZ-EF25VGW MSZ-EF35VGW MSZ-EF42VGW MSZ-EF50VGW
 MSZ-EF18VGB MSZ-EF22VGB MSZ-EF25VGB MSZ-EF35VGB MSZ-EF42VGB MSZ-EF50VGB
 MSZ-EF18VGS MSZ-EF22VGS MSZ-EF25VGS MSZ-EF35VGS MSZ-EF42VGS MSZ-EF50VGS
 MSZ-EF18VGKW MSZ-EF22VGKW MSZ-EF25VGKW MSZ-EF35VGKW MSZ-EF42VGKW MSZ-EF50VGKW
 MSZ-EF18VGKB MSZ-EF22VGKB MSZ-EF25VGKB MSZ-EF35VGKB MSZ-EF42VGKB MSZ-EF50VGKB
 MSZ-EF18VGKS MSZ-EF22VGKS MSZ-EF25VGKS MSZ-EF35VGKS MSZ-EF42VGKS MSZ-EF50VGKS

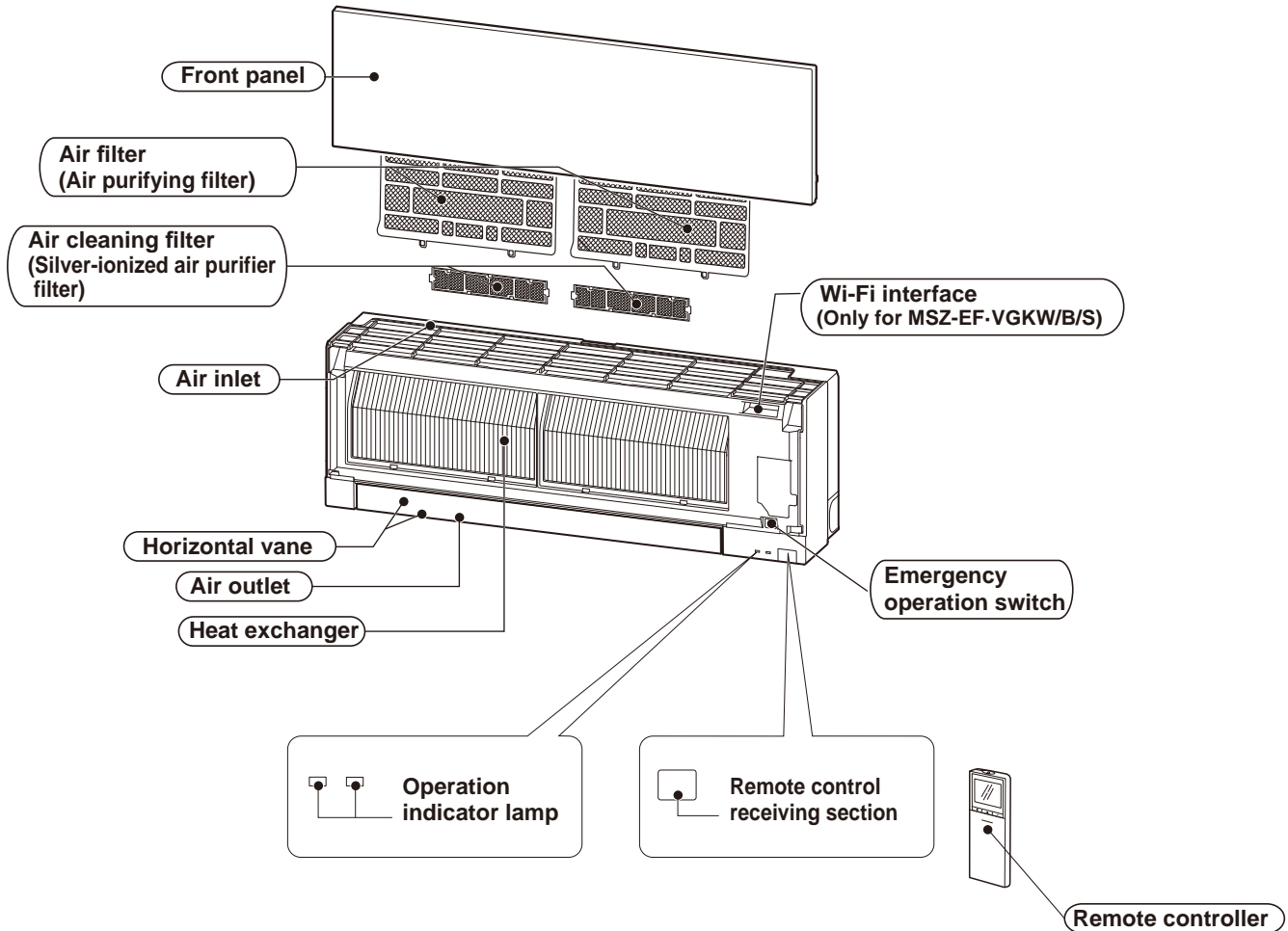

ACCESSORIES

Model	MSZ-EF18VGW MSZ-EF18VGB MSZ-EF18VGS MSZ-EF22VGW MSZ-EF22VGB MSZ-EF22VGS MSZ-EF25VGW MSZ-EF25VGB MSZ-EF25VGS MSZ-EF35VGW MSZ-EF35VGB MSZ-EF35VGS MSZ-EF42VGW MSZ-EF42VGB MSZ-EF42VGS MSZ-EF50VGW MSZ-EF50VGB MSZ-EF50VGS MSZ-EF18VGKW MSZ-EF18VGKB MSZ-EF18VGKS MSZ-EF22VGKW MSZ-EF22VGKB MSZ-EF22VGKS MSZ-EF25VGKW MSZ-EF25VGKB MSZ-EF25VGKS MSZ-EF35VGKW MSZ-EF35VGKB MSZ-EF35VGKS MSZ-EF42VGKW MSZ-EF42VGKB MSZ-EF42VGKS MSZ-EF50VGKW MSZ-EF50VGKB MSZ-EF50VGKS
① Installation plate	1
② Installation plate fixing screw 4 × 25 mm	5
③ Battery (AAA) for remote controller	2
④ Wireless remote controller	1
⑤ Felt tape (For left or left-rear piping)	1
⑥ Soft dry cloth (VGB type only)	1
⑦ Air cleaning filter	2

3

SPECIFICATION

Indoor model				MSZ-EF18VGW MSZ-EF18VGB MSZ-EF18VGS MSZ-EF18VGKW MSZ-EF18VGKB MSZ-EF18VGKS	MSZ-EF22VGW MSZ-EF22VGB MSZ-EF22VGS MSZ-EF22VGKW MSZ-EF22VGKB MSZ-EF22VGKS	MSZ-EF25VGW MSZ-EF25VGB MSZ-EF25VGS MSZ-EF25VGKW MSZ-EF25VGKB MSZ-EF25VGKS	MSZ-EF35VGW MSZ-EF35VGB MSZ-EF35VGS MSZ-EF35VGKW MSZ-EF35VGKB MSZ-EF35VGKS				
Power supply				Single phase 230 V, 50 Hz							
Electrical data	Power input *1	Cooling	W	20							
		Heating		26		30					
Electrical data	Running current *1	Cooling	A	0.20							
		Heating		0.26		0.29					
Fan motor	Model			RC0J40							
	Current *1	Cooling	A	0.20							
Heating		0.26		0.29							
Dimensions W × H × D			mm	885 × 299 × 195							
Weight			kg	11.5							
Special remarks				Air direction				5			
				Airflow	Cooling	Super High	m³/h	630			
						High		498			
						Med.		378			
						Low		276			
						Silent		240			
					Heating	Super High	m³/h	714		762	
						High		534			
						Med.		372			
						Low		276			
						Silent		240			
				Sound level	Cooling	Super High	dB(A)	42			
						High		36			
						Med.		29		30	
						Low		23		24	
						Silent		19		21	
					Heating	Super High	dB(A)	45		46	
						High		37		38	
						Med.		29		30	
						Low		24			
Silent	21										
Fan speed	Cooling	Super High	rpm	1,200							
		High		990							
		Med.		800							
		Low		630							
		Silent		570							
	Heating	Super High	rpm	1,330		1,400					
		High		1,050							
		Med.		790							
		Low		630							
		Silent		570							
Fan speed regulator				5							
Remote controller model				W: SG19A B,S: SG19B							

NOTE: Test conditions are based on ISO 5151.

Cooling: Indoor Dry-bulb temperature 27°C Wet-bulb temperature 19°C

Outdoor Dry-bulb temperature 35°C

Heating: Indoor Dry-bulb temperature 20°C

Outdoor Dry-bulb temperature 7°C Wet-bulb temperature 6°C

*1 Measured under rated operating frequency.

Specifications and rated conditions of main electric parts

Fuse	(F11)	T3.15AL250V
Horizontal vane motor	(MV)	12 V DC
Varistor	(NR11)	470 V
Terminal block	(TB)	3P



Indoor model			MSZ-EF42VGW MSZ-EF42VGB MSZ-EF42VGS MSZ-EF42VGKW MSZ-EF42VGKB MSZ-EF42VGKS	MSZ-EF50VGW MSZ-EF50VGB MSZ-EF50VGS MSZ-EF50VGKW MSZ-EF50VGKB MSZ-EF50VGKS		
Power supply			Single phase 230 V, 50 Hz			
Electrical data	Power input *1	Cooling	W	23	23	
		Heating		33	43	
	Running current *1	Cooling	A	0.23	0.23	
		Heating		0.31	0.39	
Fan motor	Model		RC0J40			
	Current *1	Cooling	A	0.23	0.23	
		Heating		0.31	0.39	
Dimensions W × H × D			mm 885 × 299 × 195			
Weight			kg 11.5			
Special remarks	Air direction		5			
	Airflow	Cooling	Super High	m³/h	672	678
			High		534	552
			Med.		462	474
			Low		396	408
			Silent		348	
		Heating	Super High	m³/h	792	876
			High		594	666
			Med.		468	540
			Low		378	432
			Silent		330	384
	Sound level	Cooling	Super High	dB(A)	43	43
			High		39	40
			Med.		35	36
			Low		31	33
			Silent		28	30
		Heating	Super High	dB(A)	48	49
			High		41	43
			Med.		35	37
			Low		30	33
			Silent		28	30
	Fan speed	Cooling	Super High	rpm	1,260	1,270
			High		1,050	1,080
			Med.		930	950
Low			830		850	
Silent			750			
Heating		Super High	rpm	1,440	1,570	
		High		1,140	1,250	
		Med.		940	1,060	
		Low		800	890	
		Silent		720	810	
Fan speed regulator			5			
Remote controller model			W: SG19A B,S: SG19B			

NOTE: Test conditions are based on ISO 5151.
Cooling: Indoor Dry-bulb temperature 27°C Wet-bulb temperature 19°C
Outdoor Dry-bulb temperature 35°C
Heating: Indoor Dry-bulb temperature 20°C
Outdoor Dry-bulb temperature 7°C Wet-bulb temperature 6°C
*1 Measured under rated operating frequency.

Specifications and rated conditions of main electric parts

Fuse	(F11)	T3.15AL250V
Horizontal vane motor	(MV)	12 V DC
Varistor	(NR11)	470 V
Terminal block	(TB)	3P

4

NOISE CRITERIA CURVES

MSZ-EF18VGW MSZ-EF22VGW MSZ-EF25VGW MSZ-EF18VGKW MSZ-EF22VGKW MSZ-EF25VGKW
MSZ-EF18VGB MSZ-EF22VGB MSZ-EF25VGB MSZ-EF18VGKB MSZ-EF22VGKB MSZ-EF25VGKB
MSZ-EF18VGS MSZ-EF22VGS MSZ-EF25VGS MSZ-EF18VGKS MSZ-EF22VGKS MSZ-EF25VGKS

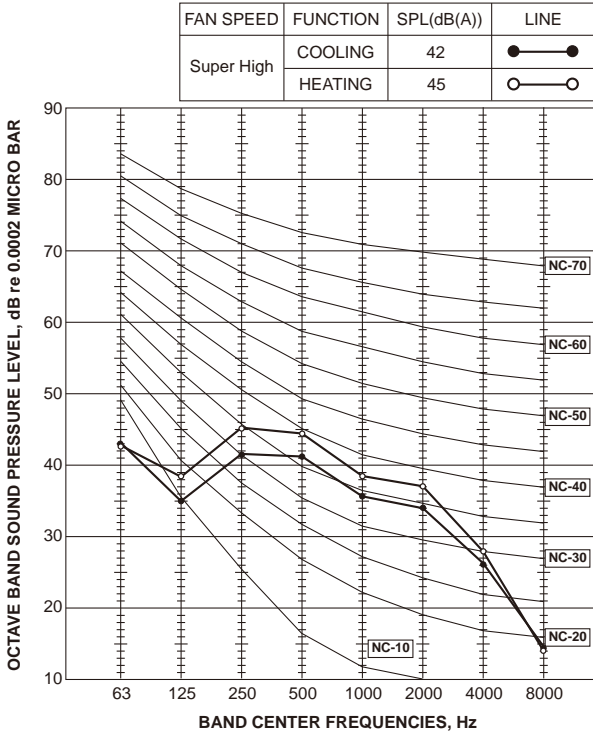

MSZ-EF35VGW MSZ-EF35VGKW
MSZ-EF35VGB MSZ-EF35VGKB
MSZ-EF35VGS MSZ-EF35VGKS

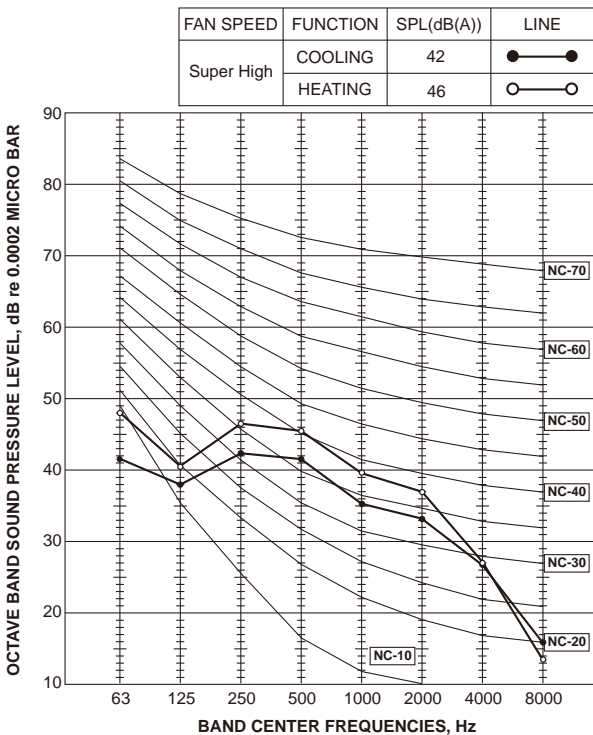

MSZ-EF42VGW MSZ-EF42VGKW
MSZ-EF42VGB MSZ-EF42VGKB
MSZ-EF42VGS MSZ-EF42VGKS

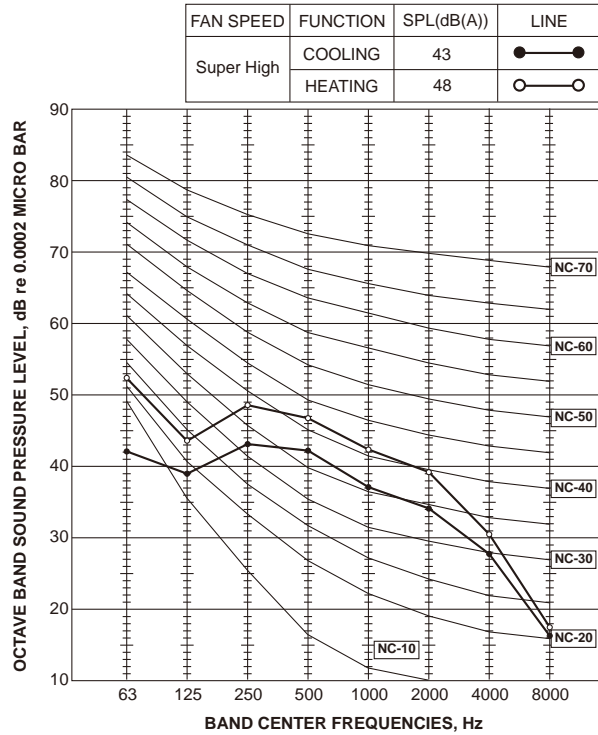

MSZ-EF50VGW MSZ-EF50VGKW
MSZ-EF50VGB MSZ-EF50VGKB
MSZ-EF50VGS MSZ-EF50VGKS

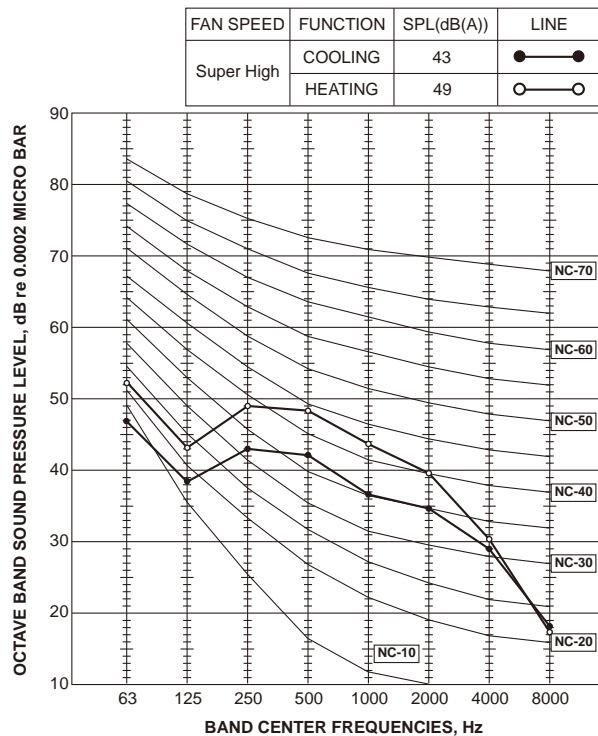

Test conditions

Cooling: Dry-bulb temperature 27 °C
Wet-bulb temperature 19 °C
Heating: Dry-bulb temperature 20 °C

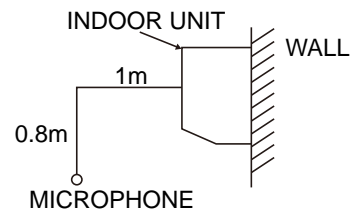

5

OUTLINES AND DIMENSIONS

MSZ-EF18VGW MSZ-EF22VGW MSZ-EF25VGW MSZ-EF35VGW MSZ-EF42VGW MSZ-EF50VGW
MSZ-EF18VGB MSZ-EF22VGB MSZ-EF25VGB MSZ-EF35VGB MSZ-EF42VGB MSZ-EF50VGB
MSZ-EF18VGS MSZ-EF22VGS MSZ-EF25VGS MSZ-EF35VGS MSZ-EF42VGS MSZ-EF50VGS
MSZ-EF18VGKW MSZ-EF22VGKW MSZ-EF25VGKW MSZ-EF35VGKW MSZ-EF42VGKW MSZ-EF50VGKW
MSZ-EF18VGKB MSZ-EF22VGKB MSZ-EF25VGKB MSZ-EF35VGKB MSZ-EF42VGKB MSZ-EF50VGKB
MSZ-EF18VGKS MSZ-EF22VGKS MSZ-EF25VGKS MSZ-EF35VGKS MSZ-EF42VGKS MSZ-EF50VGKS

Unit: mm

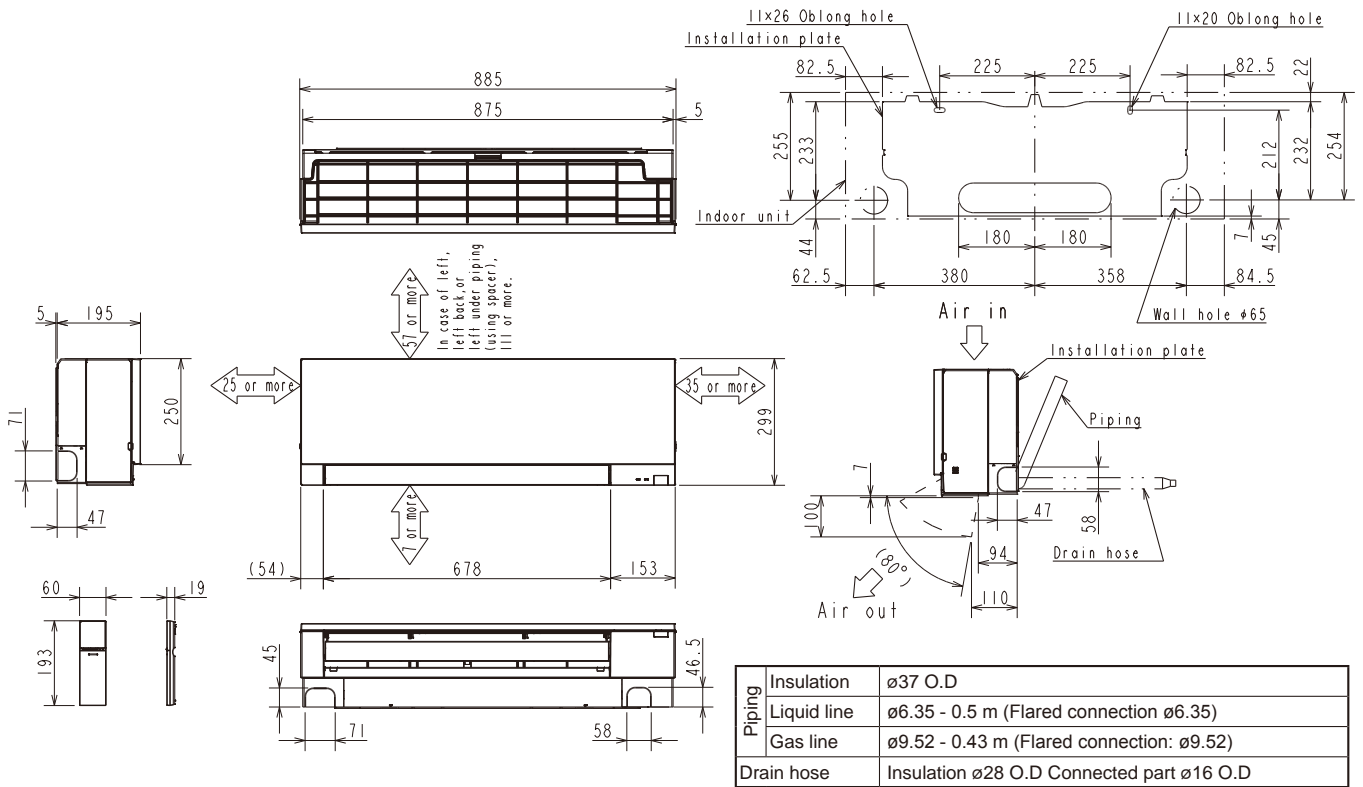

6

WIRING DIAGRAM

- | | | |
|---------------------------------|---------------------------------|---------------------------------|
| MSZ-EF18VGW- [E1] | MSZ-EF22VGW- [E1], [ET1] | MSZ-EF25VGW- [E1], [ET1] |
| MSZ-EF35VGW- [E1], [ET1] | MSZ-EF42VGW- [E1], [ET1] | MSZ-EF50VGW- [E1], [ET1] |
| MSZ-EF18VGB- [E1] | MSZ-EF22VGB- [E1], [ET1] | MSZ-EF25VGB- [E1], [ET1] |
| MSZ-EF35VGB- [E1], [ET1] | MSZ-EF42VGB- [E1], [ET1] | MSZ-EF50VGB- [E1], [ET1] |
| MSZ-EF18VGS- [E1] | MSZ-EF22VGS- [E1], [ET1] | MSZ-EF25VGS- [E1], [ET1] |
| MSZ-EF35VGS- [E1], [ET1] | MSZ-EF42VGS- [E1], [ET1] | MSZ-EF50VGS- [E1], [ET1] |

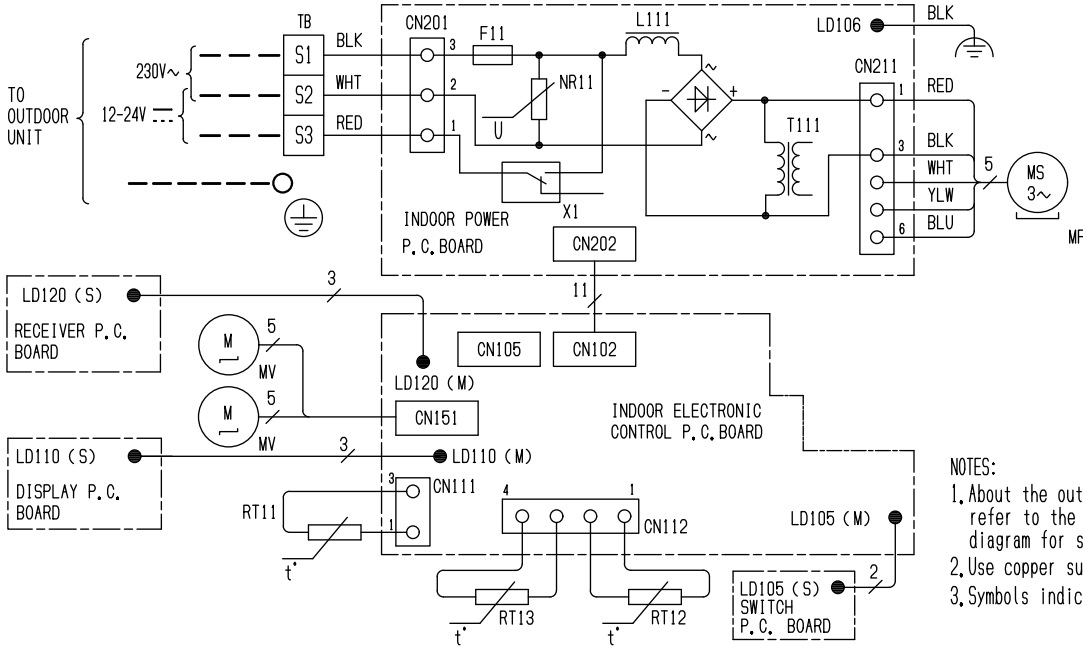

SYMBOL	NAME
F11	FUSE (T3, 15A/250V)
L111	REACTOR
MF	FAN MOTOR
MV	VANE MOTOR
NR11	VARISTOR
RT11	ROOM TEMP. THERMISTOR
RT12	COIL TEMP. THERMISTOR (MAIN)
RT13	COIL TEMP. THERMISTOR (SUB)
T111	TRANSFORMER
TB	TERMINAL BLOCK
X1	RELAY

NOTES:

- About the outdoor side electronic wiring refer to the outdoor unit electronic wiring diagram for servicing.
- Use copper supply wires
- Symbols indicate, : Terminal block
 : Connector

MSZ-EF18VGW- E2 MSZ-EF22VGW- E2 MSZ-EF25VGW- E2 MSZ-EF35VGW- E2 MSZ-EF42VGW- E2
 MSZ-EF18VGB- E2 MSZ-EF22VGB- E2 MSZ-EF25VGB- E2 MSZ-EF35VGB- E2 MSZ-EF42VGB- E2
 MSZ-EF18VGS- E2 MSZ-EF22VGS- E2 MSZ-EF25VGS- E2 MSZ-EF35VGS- E2 MSZ-EF42VGS- E2

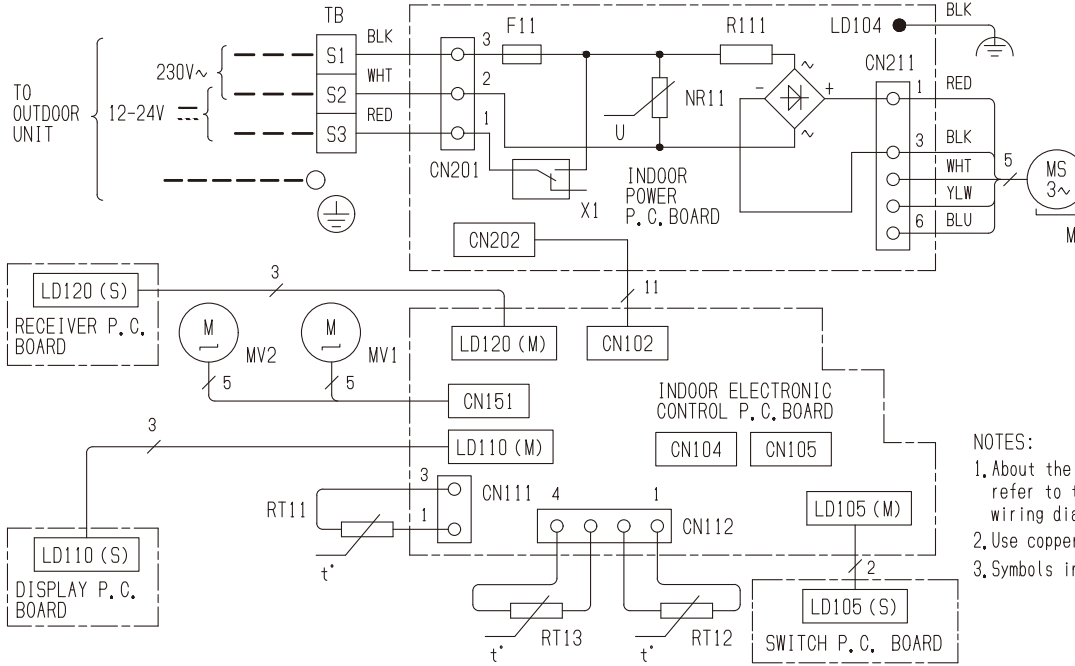

SYMBOL	NAME
F11	FUSE (T3, 15AL250V)
MF	FAN MOTOR
MV1	VANE MOTOR (HORIZONTAL UPPER)
MV2	VANE MOTOR (HORIZONTAL LOWER)
NR11	VARISTOR
R111	RESISTOR
RT11	ROOM TEMP. THERMISTOR
RT12	COIL TEMP. THERMISTOR (MAIN)
RT13	COIL TEMP. THERMISTOR (SUB)
TB	TERMINAL BLOCK
X1	RELAY

NOTES:
 1. About the outdoor side electronic wiring refer to the outdoor unit electronic wiring diagram for servicing.
 2. Use copper supply wires.
 3. Symbols indicate.

□ □ □ □ : Terminal block
 ○ ○ ○ ○ : Connector

MSZ-EF22VGW- E2 MSZ-EF25VGW- E2 MSZ-EF35VGW- E2 MSZ-EF42VGW- E2
 MSZ-EF22VGB- E2 MSZ-EF25VGB- E2 MSZ-EF35VGB- E2 MSZ-EF42VGB- E2
 MSZ-EF22VGS- E2 MSZ-EF25VGS- E2 MSZ-EF35VGS- E2 MSZ-EF42VGS- E2

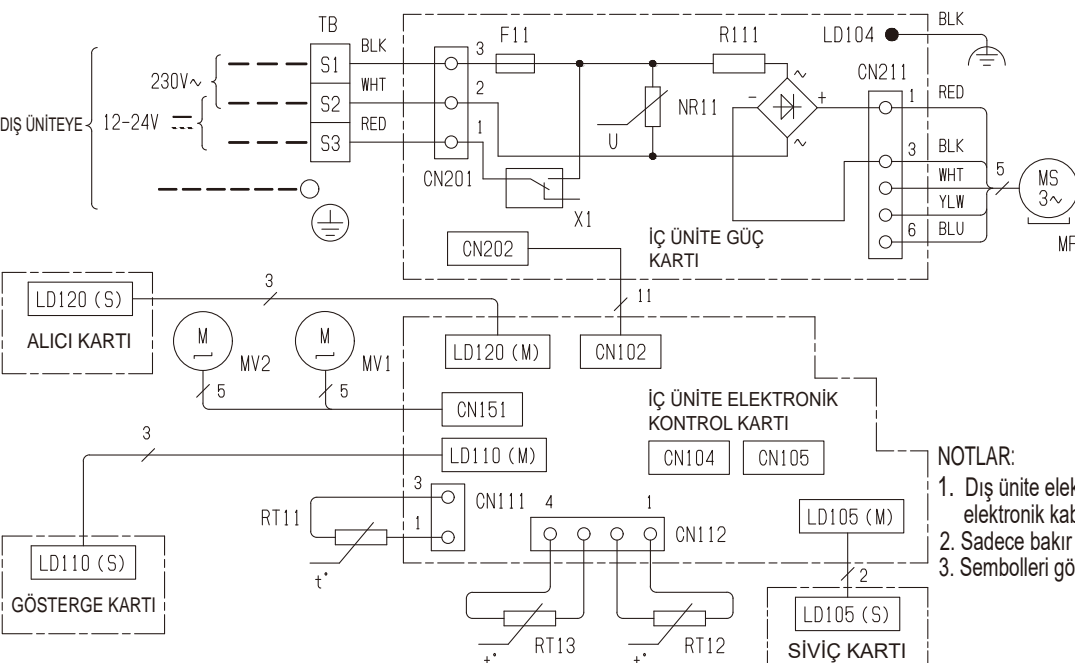

SEMBOL	PARÇA ADI
F11	SİĞORTA (T3.15AL250V)
MF	FAN MOTORU
MV1	KANAT MOTORU (YATAY ÜST)
MV2	KANAT MOTORU (YATAY ALT)
NR11	VARİSTÖR
R111	RESİSTÖR
RT11	ODA SICAKLIK TERMİSTÖRÜ
RT12	BORU SICAKLIK TERMİSTÖRÜ(ANA)
RT13	BORU SICAKLIK TERMİSTÖRÜ(YARDIMCI)
TB	TERMİNAL BLOĞU
X1	RÖLE

NOTLAR:
 1. Diş ünite elektronik kabloları için diş ünite elektronik kablo devre şemasını referans alınız.
 2. Sadece bakır besleme kablosu kullanınız
 3. Sembollerini gösterir □ □ □ □ : Terminal bloğu
 ○ ○ ○ ○ : Konektör

MSZ-EF50VGW- [E2]

MSZ-EF50VGB- [E2]

MSZ-EF50VGS- [E2]

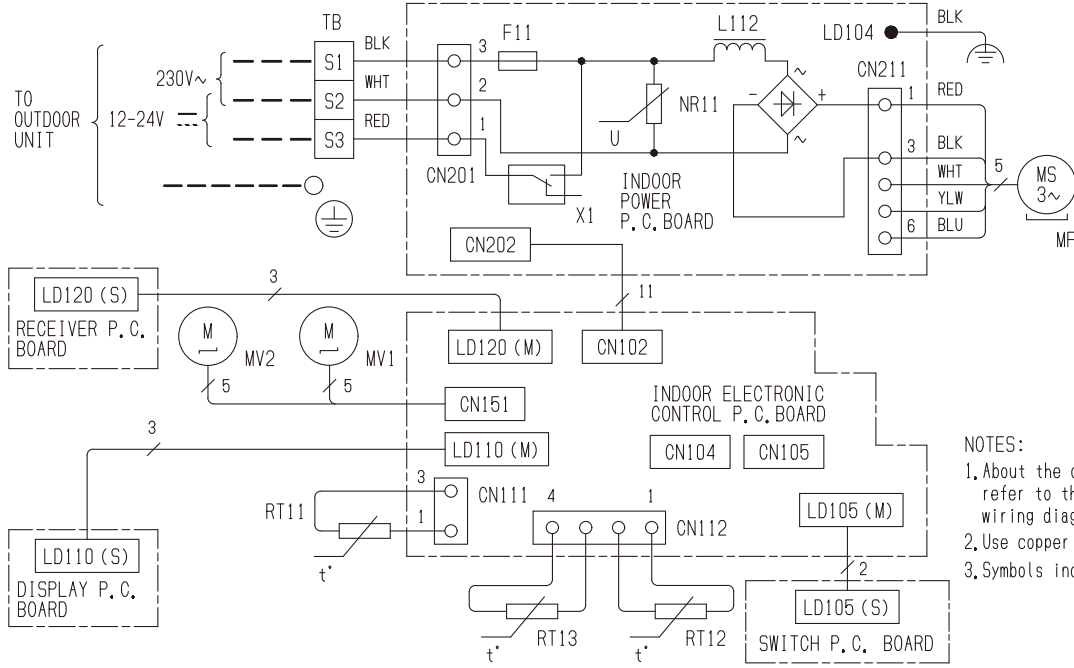

SYMBOL	NAME
F11	FUSE (T3.15A/250V)
L112	REACTOR
MF	FAN MOTOR
MV1	VANE MOTOR (HORIZONTAL UPPER)
MV2	VANE MOTOR (HORIZONTAL LOWER)
NR11	VARISTOR
RT11	ROOM TEMP. THERMISTOR
RT12	COIL TEMP. THERMISTOR (MAIN)
RT13	COIL TEMP. THERMISTOR (SUB)
TB	TERMINAL BLOCK
X1	RELAY

NOTES:

1. About the outdoor side electronic wiring refer to the outdoor unit electronic wiring diagram for servicing.
2. Use copper supply wires.
3. Symbols indicate.

□ : Terminal block
○ : Connector

MSZ-EF50VGW- [ET2]

MSZ-EF50VGB- [ET2]

MSZ-EF50VGS- [ET2]

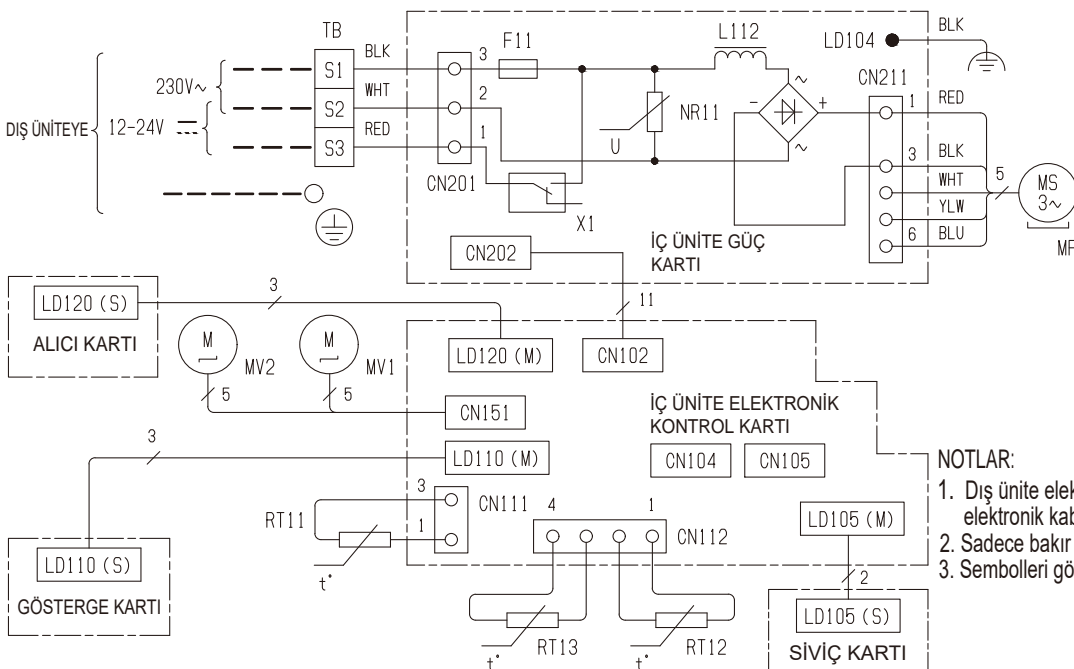

SYMBOL	NAME
F11	SİĞORTA (T3.15A/250V)
L112	REAKTÖR
MF	FAN MOTORU
MV1	KANAT MOTORU (YATAY ÜST)
MV2	KANAT MOTORU (YATAY ALT)
NR11	VARİSTÖR
RT11	ODA SICAKLIK TERMİSTÖRÜ
RT12	BORU SICAKLIK TERMİSTÖRÜ(ANA)
RT13	BORU SICAKLIK TERMİSTÖRÜ(YARDIMCI)
TB	TERMINAL BLOĞU
X1	RÖLE

NOTLAR:

1. Diş ünite elektronik kablomasi için diş ünite elektronik kablo devre şemasını referans alınız.
2. Sadece bakır besleme kablosu kullanın
3. Sembolleri gösterir □ : Terminal bloğu
○ : Konektör

MSZ-EF18VGKW- [E1] MSZ-EF22VGKW- [E1] MSZ-EF25VGKW- [E1] MSZ-EF35VGKW- [E1] MSZ-EF42VGKW- [E1]
MSZ-EF18VGBK- [E1] MSZ-EF22VGBK- [E1] MSZ-EF25VGBK- [E1] MSZ-EF35VGBK- [E1] MSZ-EF42VGBK- [E1]
MSZ-EF18VGKS- [E1] MSZ-EF22VGKS- [E1] MSZ-EF25VGKS- [E1] MSZ-EF35VGKS- [E1] MSZ-EF42VGKS- [E1]

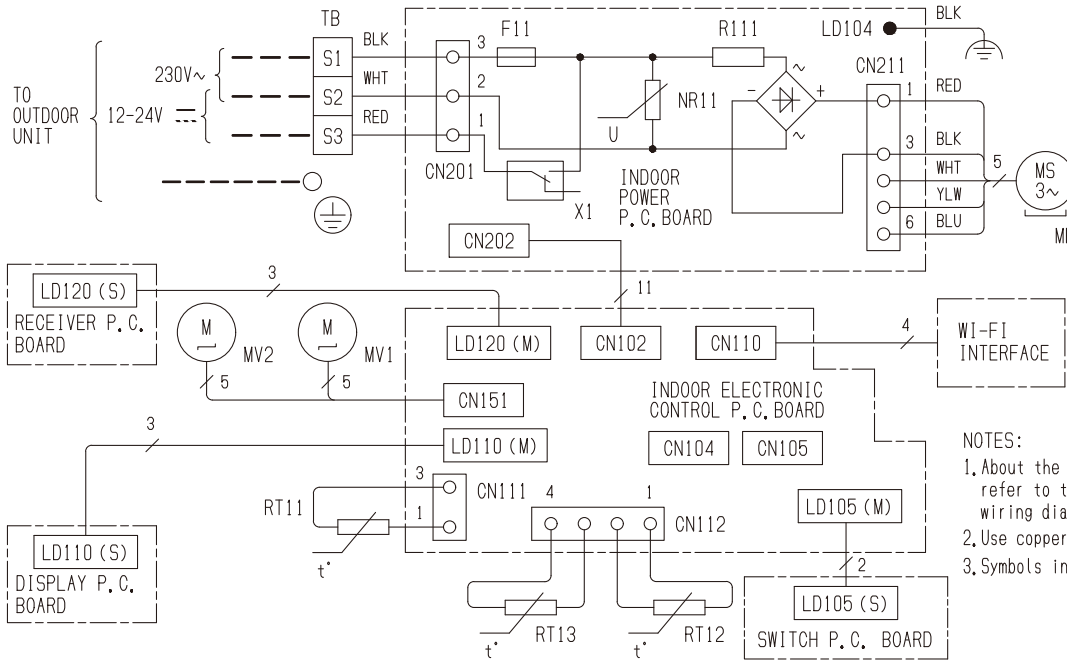

SYMBOL	NAME
F11	FUSE (T3, 15AL250V)
MF	FAN MOTOR
MV1	VANE MOTOR (HORIZONTAL UPPER)
MV2	VANE MOTOR (HORIZONTAL LOWER)
NR11	VARISTOR
R111	RESISTOR
RT11	ROOM TEMP. THERMISTOR
RT12	COIL TEMP. THERMISTOR (MAIN)
RT13	COIL TEMP. THERMISTOR (SUB)
TB	TERMINAL BLOCK
X1	RELAY

- NOTES:
- About the outdoor side electronic wiring refer to the outdoor unit electronic wiring diagram for servicing.
 - Use copper supply wires.
 - Symbols indicate.

□□□□ : Terminal block
 ○○○○ : Connector

MSZ-EF22VGKW- [E1] MSZ-EF25VGKW- [E1] MSZ-EF35VGKW- [E1] MSZ-EF42VGKW- [E1]
MSZ-EF22VGBK- [E1] MSZ-EF25VGBK- [E1] MSZ-EF35VGBK- [E1] MSZ-EF42VGBK- [E1]
MSZ-EF22VGKS- [E1] MSZ-EF25VGKS- [E1] MSZ-EF35VGKS- [E1] MSZ-EF42VGKS- [E1]

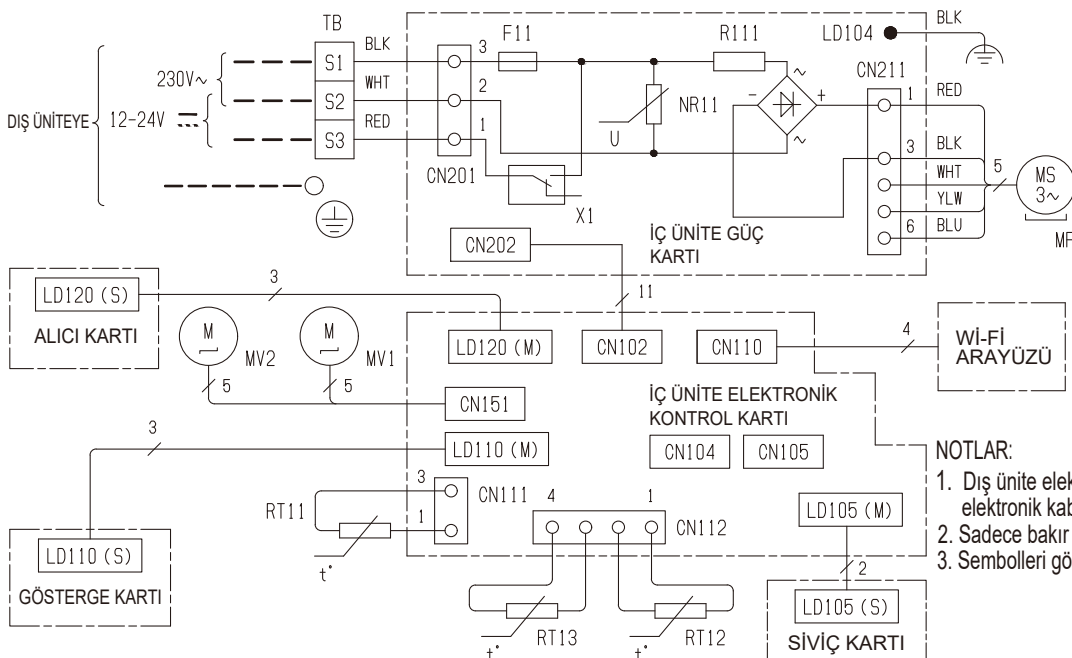

SEMBOL	PARÇA ADI
F11	SİĞORTA (T3.15AL250V)
MF	FAN MOTORU
MV1	KANAT MOTORU (YATAY ÜST)
MV2	KANAT MOTORU (YATAY ALT)
NR11	VARİSTÖR
R111	RESİTÖR
RT11	ODA SICAKLIK TERMİSTÖRÜ
RT12	BORU SICAKLIK TERMİSTÖRÜ(ANA)
RT13	BORU SICAKLIK TERMİSTÖRÜ(YARDIMCI)
TB	TERMİNAL BLOĞU
X1	RÖLE

- NOTLAR:
- Diş ünite elektronik kabloları için diş ünite elektronik kablo devre şemasını referans alınız.
 - Sadece bakır besleme kablosu kullanın
 - Semboller gösterir □□□□ : Terminal bloğu
 ○○○○ : Konektör

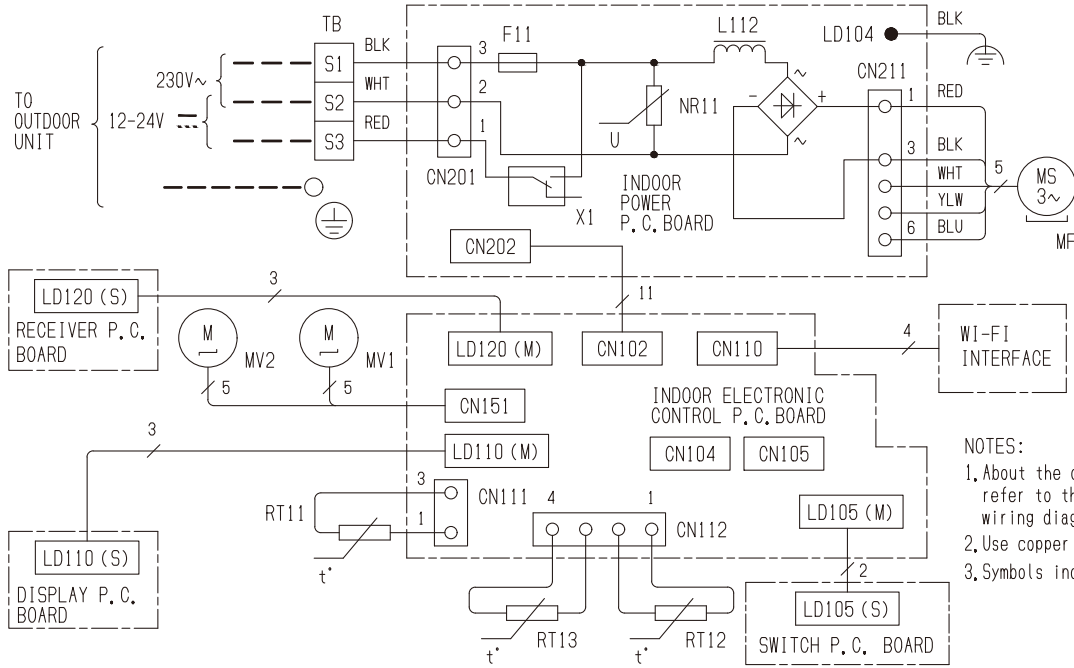
MSZ-EF50VGKW- [E1]**MSZ-EF50VGKB- [E1]****MSZ-EF50VGKS- [E1]**

SYMBOL	NAME
F11	FUSE (T3, 15AL250V)
L112	REACTOR
MF	FAN MOTOR
MV1	VANE MOTOR (HORIZONTAL UPPER)
MV2	VANE MOTOR (HORIZONTAL LOWER)
NR11	VARISTOR
RT11	ROOM TEMP. THERMISTOR
RT12	COIL TEMP. THERMISTOR (MAIN)
RT13	COIL TEMP. THERMISTOR (SUB)
TB	TERMINAL BLOCK
X1	RELAY

NOTES:

1. About the outdoor side electronic wiring refer to the outdoor unit electronic wiring diagram for servicing.
2. Use copper supply wires.
3. Symbols indicate.

□□□□ : Terminal block
○●○●○ : Connector

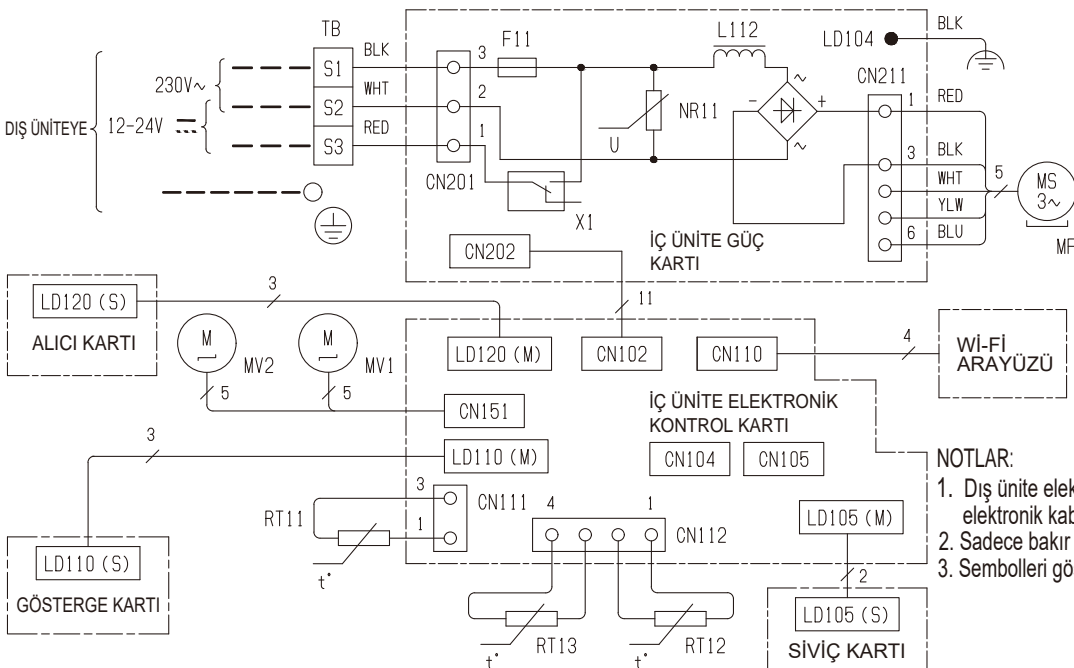
MSZ-EF50VGKW- [ET1]**MSZ-EF50VGKB- [ET1]****MSZ-EF50VGKS- [ET1]**

SYMBOL	NAME
F11	SİĞORTA (T3.15AL250V)
L112	REAKTÖR
MF	FAN MOTORU
MV1	KANAT MOTORU (YATAY ÜST)
MV2	KANAT MOTORU (YATAY ALT)
NR11	VARİSTÖR
RT11	ODA SICAKLIK TERMİSTÖRÜ
RT12	BORU SICAKLIK TERMİSTÖRÜ(ANA)
RT13	BORU SICAKLIK TERMİSTÖRÜ(YARDIMCI)
TB	TERMİNAL BLOĞU
X1	RÖLE

NOTLAR:

1. Dış ünite elektronik kabloları için dış ünite elektronik kablo devre şemasını referans alınız.
2. Sadece bakır besleme kablosu kullanın
3. Sembollerini gösterir □□□□ : Terminal bloğu
○●○●○ : Konektör

7

REFRIGERANT SYSTEM DIAGRAM

MSZ-EF18VGW MSZ-EF22VGW MSZ-EF25VGW MSZ-EF35VGW MSZ-EF42VGW MSZ-EF50VGW
 MSZ-EF18VGB MSZ-EF22VGB MSZ-EF25VGB MSZ-EF35VGB MSZ-EF42VGB MSZ-EF50VGB
 MSZ-EF18VGS MSZ-EF22VGS MSZ-EF25VGS MSZ-EF35VGS MSZ-EF42VGS MSZ-EF50VGS
 MSZ-EF18VGKW MSZ-EF22VGKW MSZ-EF25VGKW MSZ-EF35VGKW MSZ-EF42VGKW MSZ-EF50VGKW
 MSZ-EF18VGKB MSZ-EF22VGKB MSZ-EF25VGKB MSZ-EF35VGKB MSZ-EF42VGKB MSZ-EF50VGKB
 MSZ-EF18VGKS MSZ-EF22VGKS MSZ-EF25VGKS MSZ-EF35VGKS MSZ-EF42VGKS MSZ-EF50VGKS

Unit: mm

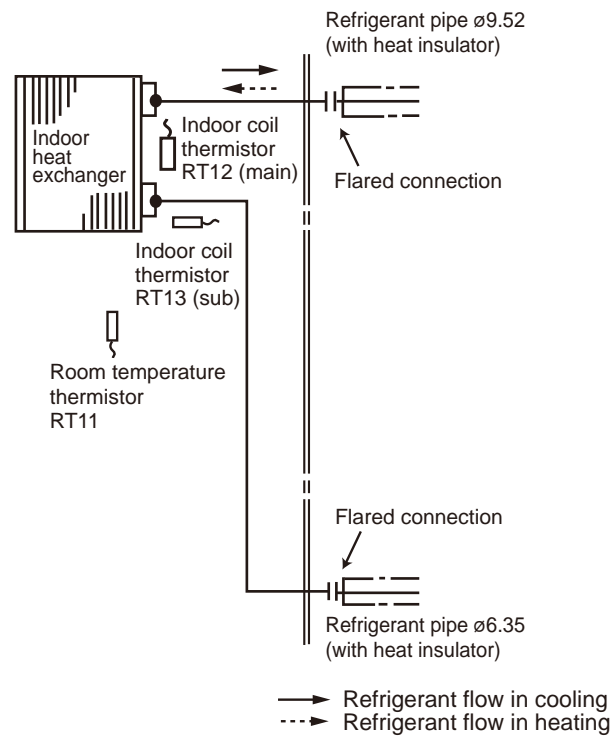

MSZ-EF18VGW MSZ-EF22VGW MSZ-EF25VGW MSZ-EF35VGW MSZ-EF42VGW MSZ-EF50VGW
 MSZ-EF18VGB MSZ-EF22VGB MSZ-EF25VGB MSZ-EF35VGB MSZ-EF42VGB MSZ-EF50VGB
 MSZ-EF18VGS MSZ-EF22VGS MSZ-EF25VGS MSZ-EF35VGS MSZ-EF42VGS MSZ-EF50VGS
 MSZ-EF18VGKW MSZ-EF22VGKW MSZ-EF25VGKW MSZ-EF35VGKW MSZ-EF42VGKW MSZ-EF50VGKW
 MSZ-EF18VGKB MSZ-EF22VGKB MSZ-EF25VGKB MSZ-EF35VGKB MSZ-EF42VGKB MSZ-EF50VGKB
 MSZ-EF18VGKS MSZ-EF22VGKS MSZ-EF25VGKS MSZ-EF35VGKS MSZ-EF42VGKS MSZ-EF50VGKS

8-1. TIMER SHORT MODE

For service, the following set time can be shortened by bridging JPG and JPS/the timer short mode point* on the electronic control P.C. board. (Refer to 10-7.)

- The set time for the ON/OFF timer can be reduced to 1 second for each minute.
- After the breaker is turned on, the time for starting the compressor, which normally takes 3 minutes, can be reduced to 1 minute. Restarting the compressor, which takes 3 minutes, cannot be reduced.

* JPG and JPS: **MSZ-EF-VG-** [E1], [ET1]

Timer short mode point: **MSZ-EF-VG-** [E2], [ET2], **MSZ-EF-VGK-** [E1], [ET1]

8-2. HOW TO SET REMOTE CONTROLLER EXCLUSIVELY FOR A PARTICULAR INDOOR UNIT

A maximum of 4 indoor units with wireless remote controllers can be used in a room.

To operate the indoor units individually with each remote controller, assign a number to each remote controller according to the number of the indoor unit.

This setting can be set only when all the following conditions are met:

- The remote controller is powered OFF.
- Weekly timer is not set.
- Weekly timer is not being edited.

- (1) Hold down [1~4] button on the remote controller for 2 seconds to enter the pairing mode.
- (2) Press [1~4] button again and assign a number to each remote controller.
Each press of [1~4] button advances the number in the following order: 1 → 2 → 3 → 4.
- (3) Press [EDIT/SEND SET] button to complete the pairing setting.

After you turn the breaker ON, the remote controller that first sends a signal to an indoor unit will be regarded as the remote controller for the indoor unit.

Once they are set, the indoor unit will only receive the signal from the assigned remote controller afterwards.

8-3. AUTO RESTART FUNCTION

When the indoor unit is controlled with the remote controller, the operation mode, the set temperature, and the fan speed are memorized by the indoor electronic control P.C. board. "AUTO RESTART FUNCTION" automatically starts operation in the same mode just before the shutoff of the main power.

Operation

- ① If the main power has been cut, the operation settings remain.
- ② After the power is restored, the unit restarts automatically according to the memory.
(However, it takes at least 3 minutes for the compressor to start running.)

How to disable "AUTO RESTART FUNCTION"

- ① Turn off the main power for the unit.
- ② Cut the jumper wire to JR77 on the indoor electronic control P.C. board. (Refer to 10-7.)

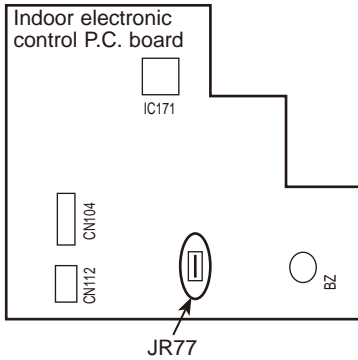

NOTE:

- The operation settings are memorized when 10 seconds have passed after the indoor unit was operated with the remote controller.
- If main power is turned OFF or a power failure occurs while AUTO START/STOP timer is active, the timer setting is cancelled.
- If the unit has been off with the remote controller before power failure, the auto restart function does not work as the power button of the remote controller is OFF.
- To prevent breaker OFF due to the rush of starting current, systematize other home appliance not to turn ON at the same time.
- When some air conditioners are connected to the same supply system, if they are operated before power failure, the starting current of all the compressors may flow simultaneously at restart. Therefore, the special counter-measures are required to prevent the main voltage-drop or the rush of the starting current by adding to the system that allows the units to start one by one.

8-4. Wi-Fi INTERFACE SETTING UP (MSZ-EF-VGKW/B/S)

This Wi-Fi interface communicates the status information and controls the commands from the MELCloud by connecting to an indoor unit.

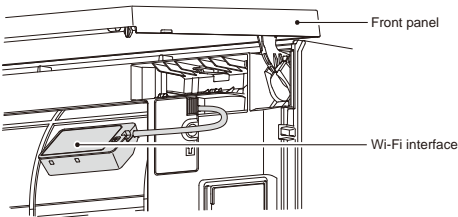
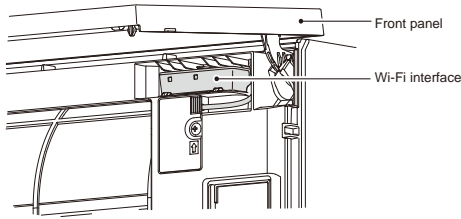

- (1) Open the front panel and remove the Wi-Fi interface.
- (2) Set up a connection between the Wi-Fi interface and the router. Refer to the SETUP MANUAL and SETUP QUICK REFERENCE GUIDE provided with the unit.

For SETUP MANUAL, please go to the website below.
<http://www.melcloud.com/Support>

- (3) Put the Wi-Fi interface back and close the front panel after the setup is completed.
- (4) For MELCloud User Manual, please go to the website below.
<http://www.melcloud.com/Support>

NOTE:

- Ensure that the Router supports the WPA2-AES encryption setting before starting the Wi-Fi interface setup.
- The End user should read and accept the terms and conditions of the Wi-Fi service before using this Wi-Fi interface.
- To complete connection of this Wi-Fi interface to the Wi-Fi service, the Router may be required.
- This Wi-Fi interface will not commence transmission of any operational data from the system until the End user registers and accepts the terms and conditions of the Wi-Fi service.
- This Wi-Fi interface should not be installed and connected to any Mitsubishi Electric system which is to provide application critical cooling or heating.
- At the time of relocation or disposal, reset the Wi-Fi interface to the factory default.

Wi-Fi interface introduction

No.	Item	Description
1	MODE switch	It selects modes.
2	RESET switch	It resets the system and ALL settings.
3	ERR LED (Orange)	It shows the network error state.
4	NET LED (Green)	It shows the network state.
5	MODE LED (Orange)	It shows the Access point mode state.
6	UNIT LED (Green)	It shows the indoor unit state.

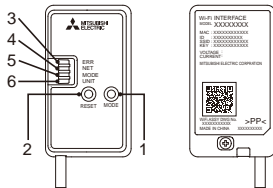

- (1) MODE switch
 - The MODE switch is used for selecting modes in configurations.
- (2) RESET switch
 - Hold down the RESET switch for 2 seconds to reboot the system.
 - Hold down the RESET switch for 14 seconds to initialize the Wi-Fi interface to the factory default.

NOTE:

When the Wi-Fi interface is reset to the factory default, ALL the configuration information will be lost. Take great care in implementing this operation.

Mitsubishi Electric's Wi-Fi interface is designed for communication to Mitsubishi Electric's MELCloud Wi-Fi service.
 Third party Wi-Fi interfaces cannot be connected to MELCloud.
 Mitsubishi Electric is not responsible for any (i) under performance of a system or any product; (ii) system or product fault; or (iii) loss or damage to any system or product; which is caused by or arises from connection to and/or use of any third party Wi-Fi interface or any third party Wi-Fi service with Mitsubishi Electric equipment.

For the latest information regarding MELCloud from Mitsubishi Electric Corporation, please visit www.MELCloud.com.

- MSZ-EF18VGW MSZ-EF22VGW MSZ-EF25VGW MSZ-EF35VGW MSZ-EF42VGW MSZ-EF50VGW
- MSZ-EF18VGB MSZ-EF22VGB MSZ-EF25VGB MSZ-EF35VGB MSZ-EF42VGB MSZ-EF50VGB
- MSZ-EF18VGS MSZ-EF22VGS MSZ-EF25VGS MSZ-EF35VGS MSZ-EF42VGS MSZ-EF50VGS
- MSZ-EF18VGKW MSZ-EF22VGKW MSZ-EF25VGKW MSZ-EF35VGKW MSZ-EF42VGKW MSZ-EF50VGKW
- MSZ-EF18VGKB MSZ-EF22VGKB MSZ-EF25VGKB MSZ-EF35VGKB MSZ-EF42VGKB MSZ-EF50VGKB
- MSZ-EF18VGKS MSZ-EF22VGKS MSZ-EF25VGKS MSZ-EF35VGKS MSZ-EF42VGKS MSZ-EF50VGKS

WIRELESS REMOTE CONTROLLER

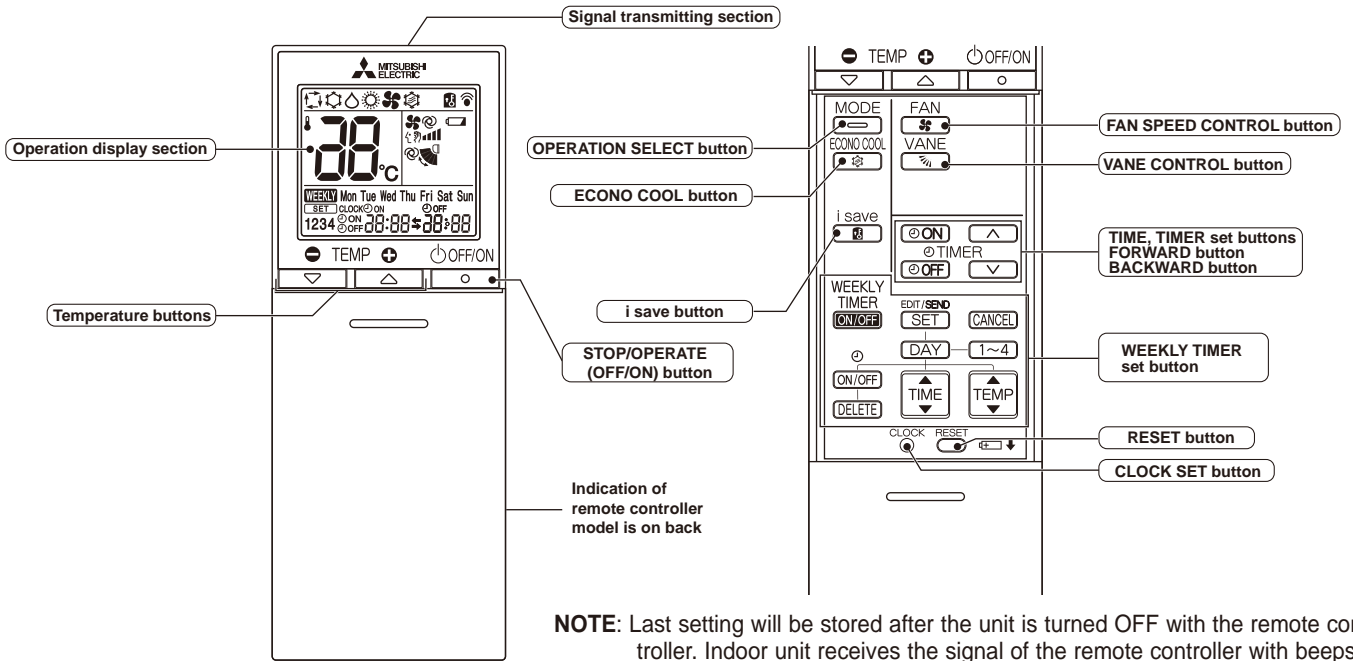

INDOOR UNIT DISPLAY SECTION

Operation Indicator lamp

The operation indicator at the right side of the indoor unit indicates the operation state.

•The following indication applies regardless of shape of the indication.

Indication	Operation state	Room temperature
● ●	The unit is operating to reach the set temperature	About 2°C or more away from set temperature
● ○	The room temperature is approaching the set temperature	About 1 to 2°C from set temperature
● ☀	Standby mode (Only during multi system operation)	—

- Lit
- ☀ Blinking
- Not lit

9-1. COOL (❄️) OPERATION

- (1) Press / STOP/OPERATE (OFF/ON) button.
OPERATION INDICATOR lamp of the indoor unit turns on with a beep tone.
- (2) Select COOL mode with OPERATION SELECT button.
- (3) Press TEMPERATURE buttons TEMP \ominus or \oplus button to select the desired temperature. The setting range is 16 - 31°C.

1. Coil frost prevention

The compressor operational frequency is controlled by the temperature of the indoor heat exchanger to prevent the coil from frosting.

When the temperature of indoor heat exchanger becomes too low, the coil frost prevention mode works.

The indoor fan operates at the set speed and the compressor stops. This mode continues until the temperature of indoor heat exchanger rises.

2. Low outside temperature operation

When the outside temperature is lower, low outside temperature operation starts, and the outdoor fan slows or stops.

3. Indoor fan speed control

When the thermostat turns OFF, the indoor fan operates very Low to reduce power consumption.

When the room temperature rises and the thermostat is ON, the indoor fan operates according to the settings on the remote controller.

9-2. DRY (☀️) OPERATION

- (1) Press STOP/OPERATE (OFF/ON) button.
OPERATION INDICATOR lamp of the indoor unit turns on with a beep tone.
- (2) Select DRY mode with OPERATION SELECT button.
- (3) The set temperature is determined from the initial room temperature.

1. Coil frost prevention

Coil frost prevention works the same way as that in COOL mode. (9-1.1.)

2. Low outside temperature operation

Low outside temperature operation works the same way as that in COOL mode. (9-1.2.)

3. Indoor fan speed control

Indoor fan speed control works the same way as that in COOL mode. (9-1.3.)

9-3. FAN (🌀) OPERATION

- (1) OPERATION INDICATOR lamp of the indoor unit turns on with a beep tone.
- (2) Select FAN mode with OPERATION SELECT button.
- (3) Select the desired fan speed. When AUTO, it becomes Low.
Only indoor fan operates.
Outdoor unit does not operate.

9-4. HEAT (🔥) OPERATION

- (1) Press STOP/OPERATE (OFF/ON) button.
OPERATION INDICATOR lamp of the indoor unit turns on with a beep tone.
- (2) Select HEAT mode with OPERATION SELECT button.
- (3) Press TEMPERATURE buttons TEMP \ominus or \oplus button to select the desired temperature. The setting range is 16 - 31°C.

1. Cold air prevention control

When the compressor is not operating or is starting, and the temperature of indoor heat exchanger and/or the room temperature is low or when defrosting is being done, the indoor fan will stop or rotate in Very Low speed.

2. High pressure protection

The compressor operational frequency is controlled by the temperature of the indoor heat exchanger to prevent the condensing pressure from increasing excessively.

When the temperature of indoor heat exchanger becomes too high, the high pressure protection works.

The indoor fan operates following the cold air prevention control. This mode continues until the temperature of indoor heat exchanger falls.

3. Defrosting

Defrosting starts when the temperature of outdoor heat exchanger becomes too low.

The compressor stops once, the indoor/outdoor fans stop, the 4-way valve reverses, and the compressor re-starts.

This mode continues until the temperature of outdoor heat exchanger rises or the fixed time passes.

9-5. AUTO CHANGE OVER --- AUTO MODE OPERATION

Once desired temperature is set, unit operation is switched automatically between COOL and HEAT operation.

Mode selection

(1) Initial mode

When unit starts the operation with AUTO operation from OFF:

- If the room temperature is higher than the set temperature, operation starts in COOL mode.
- If the room temperature is equal to or lower than the set temperature, operation starts in HEAT mode.

(2) Mode change

COOL mode changes to HEAT mode when about 15 minutes have passed with the room temperature 1°C below the set temperature.

HEAT mode changes to COOL mode when about 15 minutes have passed with the room temperature 1°C above the set temperature.

NOTE 1

If 2 or more indoor units are operating in multi system, there might be a case that the indoor unit, which is operating in □ (AUTO), cannot change over to the other operating mode (COOL ↔ HEAT) and becomes a state of standby.

Refer to **NOTE 2 “FOR MULTI SYSTEM AIR CONDITIONER”**.

NOTE 2

FOR MULTI SYSTEM AIR CONDITIONER

OUTDOOR UNIT: MXZ series

Multi system air conditioner can connect 2 or more indoor units with one outdoor unit.

- When you try to operate 2 or more indoor units with one outdoor unit simultaneously, one for the cooling and the others for heating, the operation mode of the indoor unit that operates first is selected. Other indoor units cannot operate, and operation indicator lamp blinks as shown in the figure below. In this case, please set all the indoor units to the same operation mode.

OPERATION INDICATOR

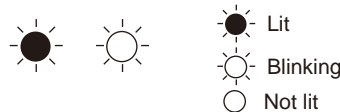

- When indoor unit starts the operation while the defrosting of outdoor unit is being done, it takes a few minutes (max. 10 minutes) to blow out the warm air.
- In the heating operation, though indoor unit that does not operate may get warm or the sound of refrigerant flowing may be heard, they are not malfunction. The reason is that the refrigerant continuously flows into it.

9-6. AUTO VANE OPERATION

1. Horizontal vane

(1) Vane motor drive

These models are equipped with a stepping motor for the horizontal vane. The rotating direction, speed, and angle of the motor are controlled by pulse signals (approximately 12 V) transmitted from indoor microprocessor.

(2) The horizontal vane angle and mode change as follows by pressing VANE CONTROL button.

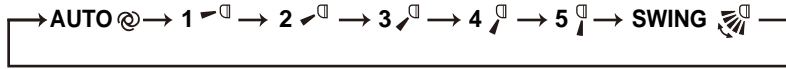

(3) Positioning

To confirm the standard position, the vane moves until it touches the vane stopper. Then the vane is set to the selected angle.

Confirming of standard position is performed in the following cases:

- When the operation starts or finishes (including timer operation).
- When the test run starts.
- When standby mode (only during multi system operation) starts or finishes.

(4) VANE AUTO (@) mode

In VANE AUTO mode, the microprocessor automatically determines the vane angle to make the optimum room temperature distribution.

In COOL and DRY operation

Vane angle is fixed to Horizontal position.



In HEAT operation

Vane angle is fixed to Angle 4.



(5) STOP (operation OFF) and ON TIMER standby

In the following cases, the horizontal vane returns to the closed position.

- When STOP/OPERATE (OFF/ON) button is pressed (POWER OFF).
- When the operation is stopped by the emergency operation.
- When ON TIMER is ON standby.

(6) Dew prevention

During COOL or DRY operation with the vane angle at Angle 4 or 5 when the compressor cumulative operation time exceeds 1 hour, the vane angle automatically changes to Angle 1 for dew prevention.

(7) SWING (with a fan icon) mode

By selecting SWING mode with VANE CONTROL button, the horizontal vanes swing vertically.

When COOL, DRY or FAN mode is selected, only the upper vane swings.

(8) Cold air prevention in HEAT operation

The horizontal vane position is set to Upward.

NOTE: When 2 or more indoor units are operated with multi outdoor unit, even if any indoor unit turns thermostat off, this control does not work in the indoor unit.

(9) ECONO COOL (with a fan icon) operation (ECONOMical operation)

When ECONO COOL button is pressed in COOL mode, set temperature is automatically set 2°C higher by microprocessor. However, the temperature on the LCD screen on the remote controller is not changed.

Also the horizontal vane swings in various cycle.

SWING operation makes you feel cooler than set temperature. So, even though the set temperature is higher, the air conditioner can keep comfort. As a result, energy can be saved.

To cancel this operation, select a different mode or press one of the following buttons in ECONO COOL operation: ECONO COOL, or VANE CONTROL button.

9-7. TIMER OPERATION

1. How to set the time

- (1) Check that the current time is set correctly.

NOTE: Timer operation will not work without setting the current time. Initially "0:00" blinks at the current time display of TIME MONITOR, so set the current time correctly with CLOCK SET button.

How to set the current time

- Press the CLOCK set button.
 - Press the TIME SET buttons ($\square\blacktriangle$ and $\square\blacktriangledown$) to set the current time.
 - Each time FORWARD button ($\square\blacktriangle$) is pressed, the set time increases by 1 minute, and each time BACKWARD button ($\square\blacktriangledown$) is pressed, the set time decreases by 1 minute.
 - Pressing those buttons longer, the set time increases/decreases by 10 minutes.
 - Press the CLOCK set button.
- (2) Press STOP/OPERATE (OFF/ON) button to start the air conditioner.
- (3) Set the time of timer.

ON timer setting

- Press ON TIMER button (ON) during operation.
- Set the time of the timer using TIME SET buttons ($\square\blacktriangle$ and $\square\blacktriangledown$).*

OFF timer setting

- Press OFF TIMER button (OFF) during operation.
 - Set the time of the timer using TIME SET buttons ($\square\blacktriangle$ and $\square\blacktriangledown$).*
- * Each time FORWARD button ($\square\blacktriangle$) is pressed, the set time increases by 10 minutes: each time BACKWARD button ($\square\blacktriangledown$) is pressed, the set time decreases by 10 minutes.

2. To release the timer

To release ON timer, press ON TIMER button (ON).

To release OFF timer, press OFF TIMER button (OFF).

TIMER is cancelled and the display of set time disappears.

PROGRAM TIMER

- OFF timer and ON timer can be used in combination. The set time that is reached first will operate first.
- " \leftarrow " and " \rightarrow " display shows the order of OFF timer and ON timer operation.

(Example 1) The current time is 8:00 PM.

The unit turns off at 11:00 PM, and on at 6:00 AM.

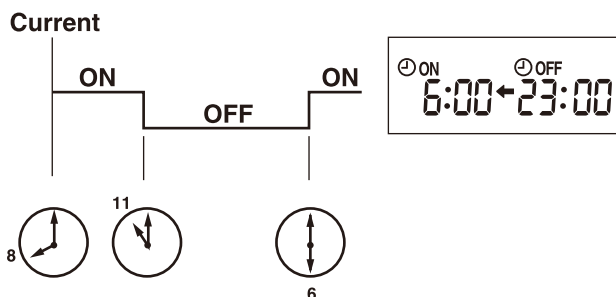

(Example 2) The current time is 11:00 AM.

The unit turns on at 5:00 PM, and off at 9:00 PM.

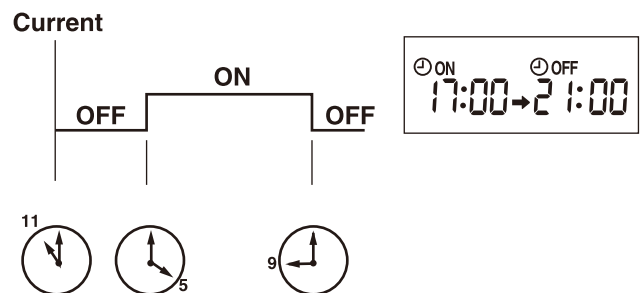

NOTE: If the main power is turned OFF or a power failure occurs while ON/OFF timer is active, the timer setting is cancelled. As these models are equipped with an auto restart function, the air conditioner starts operating with timer cancelled when power is restored.

9-8. WEEKLY TIMER OPERATION

- A maximum of 4 ON or OFF timers can be set for individual days of the week.
- A maximum of 28 ON or OFF timers can be set for a week.

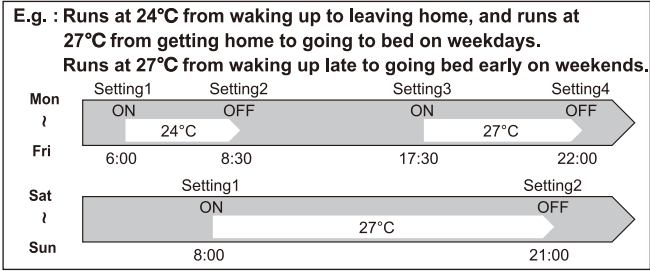

NOTE:

- The simple ON/OFF timer setting is available while the weekly timer is on. In this case, the ON/OFF timer has priority over the weekly timer; the weekly timer operation will start again after the simple ON/OFF timer is complete.
- When the weekly timer is set, temperature cannot be set to 10°C.
- The weekly timer operation and i-save operation cannot be used together.

1. How to set the weekly timer

* Make sure that the current time and day are set correctly.

(1) Press **EDIT/SEND** button to enter the weekly timer setting mode.

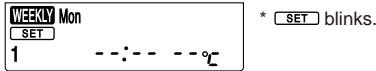

(2) Press **DAY** and **1~4** buttons to select setting day and number.

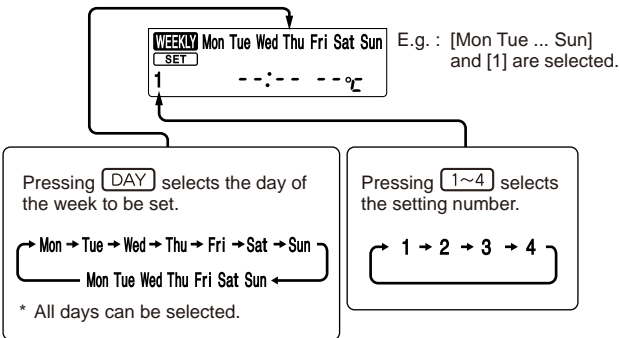

(3) Press **ON/OFF**, **TIME**, and **TEMP** buttons to set ON/OFF, time, and temperature.

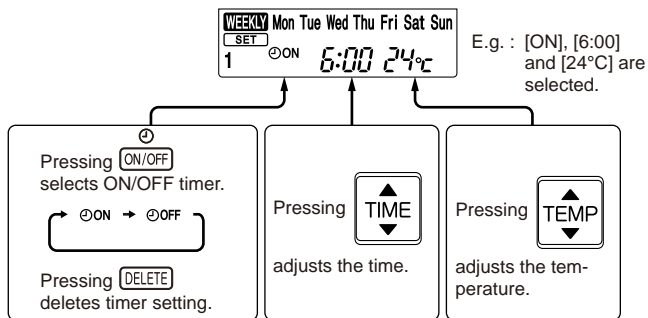

* Hold down the button to change the time quickly.





Press **DAY** and **1~4** buttons to continue setting the timer for other days and/or numbers.



(4) Press  button to complete and transmit the weekly timer setting.





*  which was blinking goes out, and the current time will be displayed.

NOTE:

- Press  button to transmit the setting information of weekly timer to the indoor unit. Point the remote controller toward the indoor unit for 3 seconds.
- When setting the timer for more than one day of the week or one number,  button does not have to be pressed per each setting. Press  button once after all the settings are complete. All the weekly timer settings will be saved.
- Press  button to enter the weekly timer setting mode, and press and hold  button for 5 seconds to erase all weekly timer settings. Point the remote controller toward the indoor unit.

(5) Press  button to turn the weekly timer ON. (.)

- When the weekly timer is ON, the day of the week whose timer setting is complete, will light.

Press  button again to turn the weekly timer OFF. (.)



NOTE:

The saved settings will not be cleared when the weekly timer is turned OFF.

2. Checking weekly timer setting

(1) Press  button to enter the weekly timer setting mode.

* blinks.

(2) Press  or  buttons to view the setting of the particular day or number.

(3) Press  button to exit the weekly timer setting.

NOTE:

When all days of the week are selected to view the settings and a different setting is included among them,  will be displayed.

9-9. i-save (iB) OPERATION

1. How to set i-save operation

- (1) Press STOP/OPERATE (OFF/ON) button.
- (2) Select COOL, HEAT or ECONO COOL mode.
- (3) Press i-save button.
- (4) Set the temperature, fan speed, and airflow direction for i-save operation.

NOTE:

- i-save operation cannot be selected during DRY or AUTO mode operation.
- The setting range of HEAT mode i-save operation is 10°C and 16 - 31°C.
- 2 groups of setting can be saved. (One for COOL/ECONO COOL, one for HEAT)
- i-save operation and the weekly timer operation cannot be used together.

2. How to cancel operation

- Press i-save button again.
- i-save operation can also be cancelled by pressing OPERATION SELECT button to change the operation mode. The same setting is select from the next time by simply pressing i-save button.

9-10. EMERGENCY/TEST OPERATION

In the case of test run operation or emergency operation, use EMERGENCY OPERATION switch on the right side of the indoor unit. Emergency operation is available when the remote controller is missing or has failed, or the batteries in the remote controller are running down. The unit will start and OPERATION INDICATOR lamp will light up.

The first 30 minutes of operation is the test run operation. This operation is for servicing. The indoor fan runs at High speed and the temperature control does not work.

After 30 minutes of test run operation, the system shifts to EMERGENCY COOL/HEAT MODE with a set temperature of 24°C. The fan speed shifts to Med. The coil frost prevention works even in the test run or the emergency operation.

In the test run or emergency operation, the horizontal vane operates in VANE AUTO (@) mode.

Emergency operation continues until EMERGENCY OPERATION switch is pressed once or twice or the unit receives any signal from the remote controller. In the latter case normal operation will start.

NOTE: Do not press EMERGENCY OPERATION switch during normal operation.

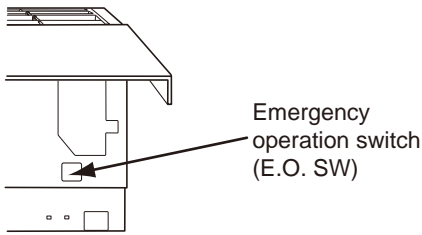

Operation mode	COOL/HEAT
Set temperature	24°C
Fan speed	Med.
Horizontal vane	Auto

The operation mode is indicated by the Operation Indicator lamp as following

Operation Indicator lamp

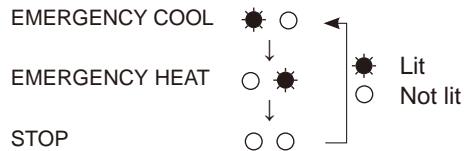

9-11. 3-MINUTE TIME DELAY OPERATION

When the system turns OFF, compressor will not restart for 3 minutes as 3-minute time delay function operates to protect compressor from overload.

MSZ-EF18VGW MSZ-EF22VGW MSZ-EF25VGW MSZ-EF35VGW MSZ-EF42VGW MSZ-EF50VGW
 MSZ-EF18VGB MSZ-EF22VGB MSZ-EF25VGB MSZ-EF35VGB MSZ-EF42VGB MSZ-EF50VGB
 MSZ-EF18VGS MSZ-EF22VGS MSZ-EF25VGS MSZ-EF35VGS MSZ-EF42VGS MSZ-EF50VGS
 MSZ-EF18VGKW MSZ-EF22VGKW MSZ-EF25VGKW MSZ-EF35VGKW MSZ-EF42VGKW MSZ-EF50VGKW
 MSZ-EF18VGKB MSZ-EF22VGKB MSZ-EF25VGKB MSZ-EF35VGKB MSZ-EF42VGKB MSZ-EF50VGKB
 MSZ-EF18VGKS MSZ-EF22VGKS MSZ-EF25VGKS MSZ-EF35VGKS MSZ-EF42VGKS MSZ-EF50VGKS

10-1. CAUTIONS ON TROUBLESHOOTING

1. Before troubleshooting, check the following

- 1) Check the power supply voltage.
- 2) Check the indoor/outdoor connecting wire for miswiring.

2. Take care of the following during servicing

- 1) Before servicing the air conditioner, be sure to turn OFF the main unit first with the remote controller, and then after confirming the horizontal vane is closed, turn OFF the breaker and/or disconnect the power plug.
- 2) Be sure to turn OFF the power supply before removing the front panel, the cabinet, the top panel, and the P.C. board.
- 3) When removing the P.C. board, hold the edge of the board with care NOT to apply stress on the components.
- 4) When connecting or disconnecting the connectors, hold the connector housing. DO NOT pull the lead wires.

<Incorrect>



Lead wiring

<Correct>

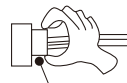

Connector housing

3. Troubleshooting procedure

- 1) Check if the OPERATION INDICATOR lamp on the indoor unit is blinking ON and OFF to indicate an abnormality. To make sure, check how many times the OPERATION INDICATOR lamp is blinking ON and OFF before starting service work.
- 2) Before servicing, check that the connector and terminal are connected properly.
- 3) When the electronic control P.C. board seems to be defective, check the copper foil pattern for disconnection and the components for bursting and discoloration.
- 4) When troubleshooting, Refer to 10-2, 10-3 and 10-4.

4. How to replace batteries

Weak batteries may cause the remote controller malfunction.

In this case, replace the batteries to operate the remote controller normally.

- ① Remove the front lid and insert batteries. Then reattach the front lid.

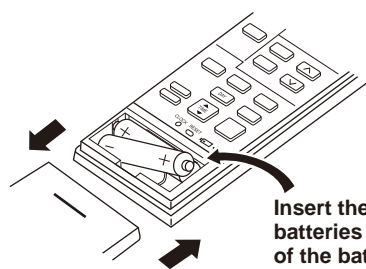

Insert the negative pole of the batteries first. Check if the polarity of the batteries is correct.

- ② Press RESET button with a thin instrument, and then use the remote controller.

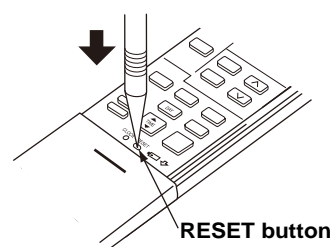

RESET button

NOTE: 1. If RESET button is not pressed, the remote controller may not operate correctly.

2. This remote controller has a circuit to automatically reset the microprocessor when batteries are replaced.

This function is equipped to prevent the microprocessor from malfunctioning due to the voltage drop caused by the battery replacement.

3. Do not use the leaking batteries.

10-2. FAILURE MODE RECALL FUNCTION

Outline of the function

This air conditioner can memorize the abnormal condition which has occurred once.

Even though LED indication listed on the troubleshooting check table (10-4.) disappears, the memorized failure details can be recalled.

1. Flow chart of failure mode recall function for the indoor/outdoor unit

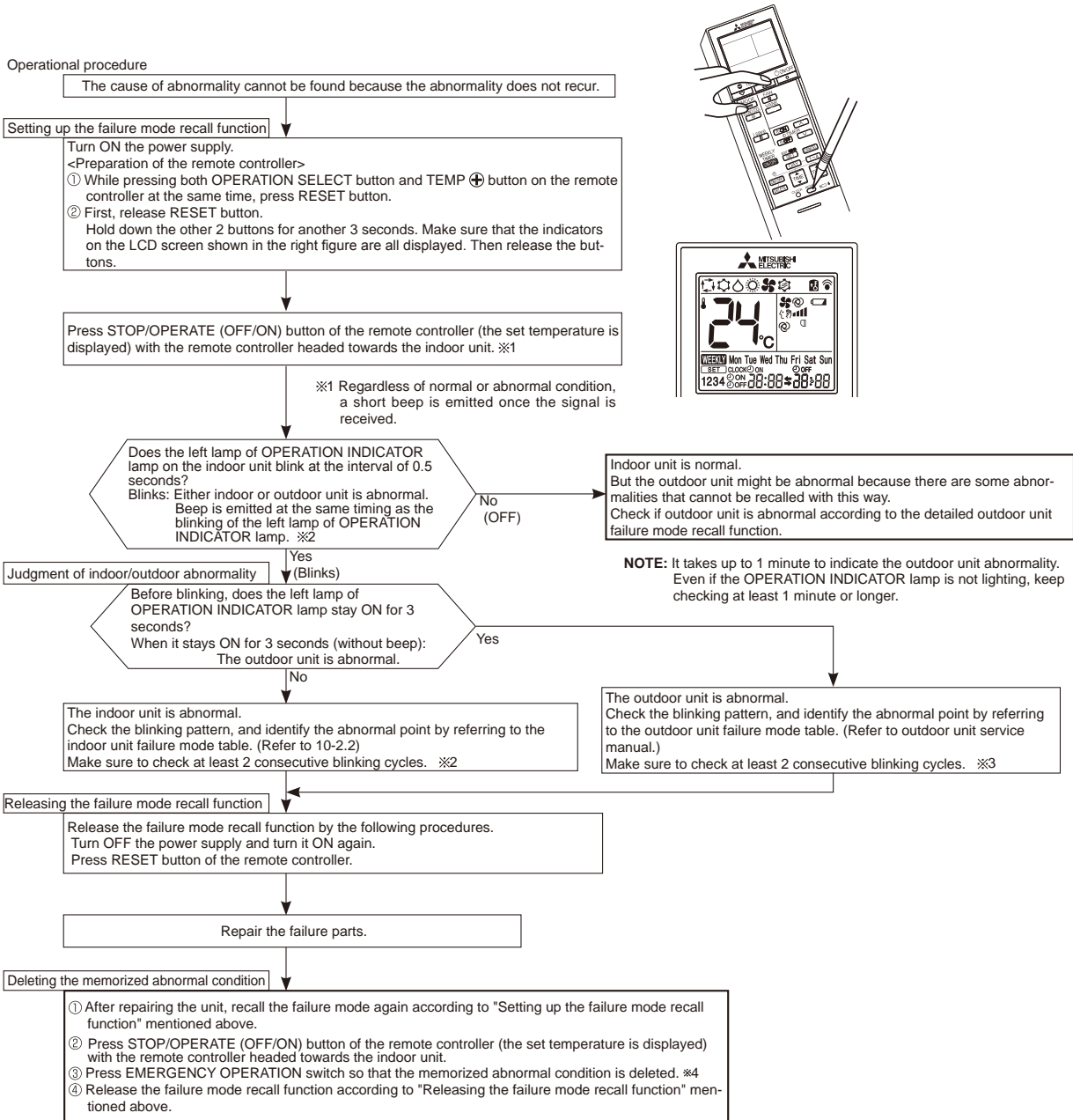

NOTE: 1. Make sure to release the failure mode recall function after it is set up, otherwise the unit cannot operate properly.
2. If the abnormal condition is not deleted from the memory, the last abnormal condition is kept memorized.

※2. Blinking pattern when the indoor unit is abnormal:

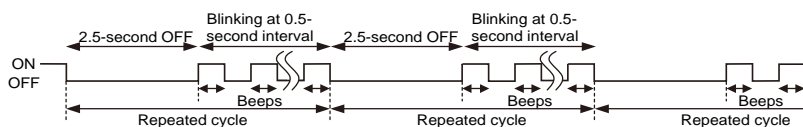

※4 The information regarding whether the connected outdoor unit is a low-standby-power model or a non-low-standby-power model will also be initialized. (Default= compatible with a low-standby-power model)

※3. Blinking pattern when the outdoor unit is abnormal:

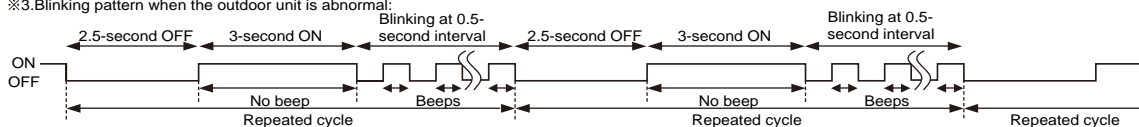



2. Table of indoor unit failure mode recall function

The left lamp of OPERATION INDICATOR lamp	Abnormal point (Failure mode)	Condition	Remedy
Not lit	Normal	—	—
1-time blink every 0.5-second	Room temperature thermistor	The room temperature thermistor short or open circuit is detected every 8 seconds during operation.	Refer to the characteristics of the room temperature thermistor (10-7.).
2-time blink 2.5-second OFF	Indoor coil thermistor	The indoor coil thermistor short or open circuit is detected every 8 seconds during operation.	Refer to the characteristics of the main indoor coil thermistor, the sub indoor coil thermistor (10-7.).
3-time blink 2.5-second OFF	Serial signal	The serial signal from outdoor unit is not received for a maximum of 6 minutes.	Refer to 10-6.Ⓒ "How to check miswiring and serial signal error".
11-time blink 2.5-second OFF	Indoor fan motor	The rotational frequency feedback signal is not emitted for the 12 seconds after the indoor fan motor is operated.	Refer to 10-6.Ⓐ "Check of indoor fan motor".
12-time blink 2.5-second OFF	Indoor control system	It cannot properly read data in the nonvolatile memory of the indoor electronic control P.C. board.	Replace the indoor electronic control P.C. board.

NOTE: Blinking patterns of this mode differ from the ones of TROUBLESHOOTING CHECK TABLE (10-4.).

10-3. INSTRUCTION OF TROUBLESHOOTING

1. Check of the unit.

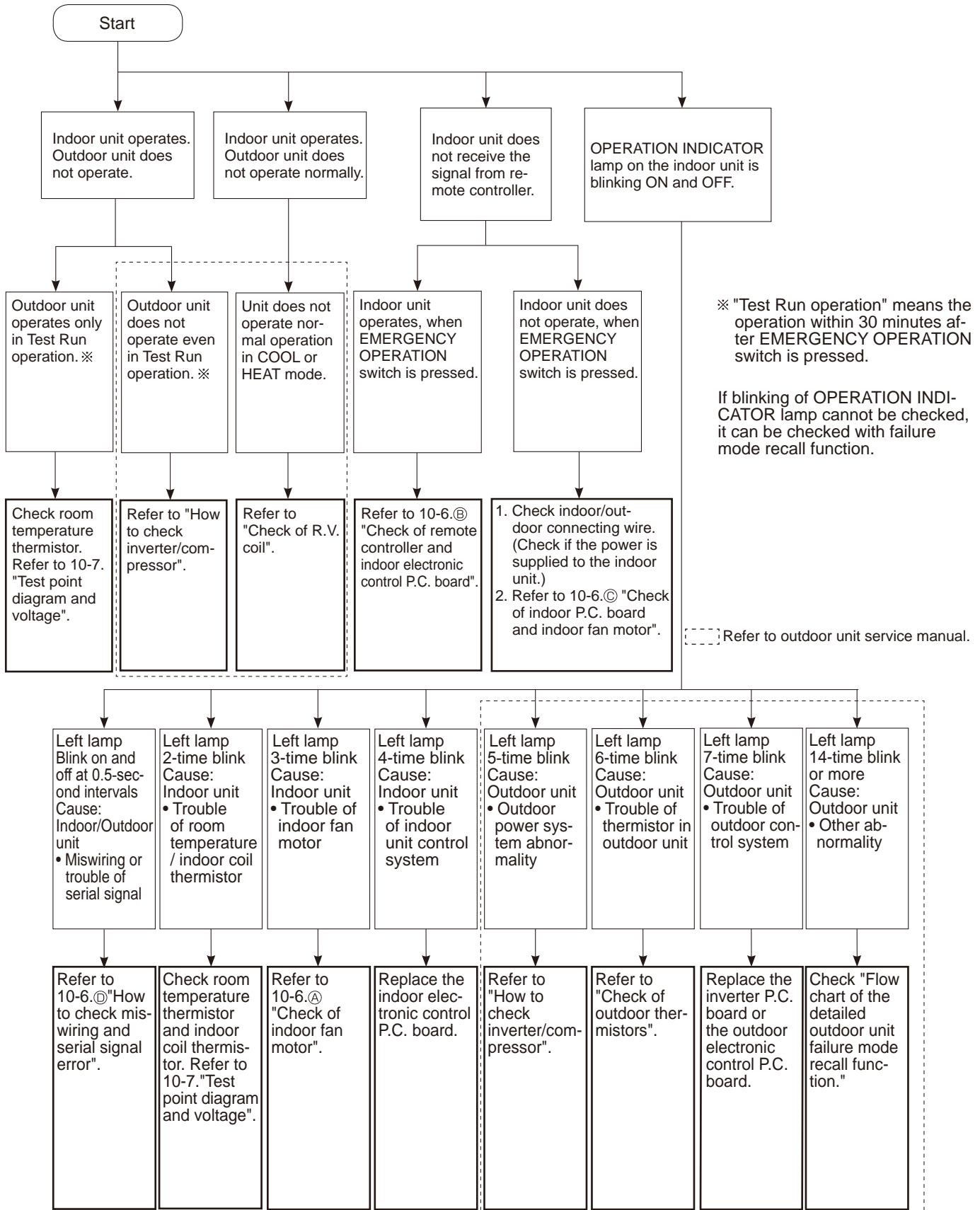

2. Check of Wi-Fi interface (MSZ-EF-VGKW/B/S)

Follow the procedure below if the air conditioner cannot be monitored or controlled with a device such as a smartphone.

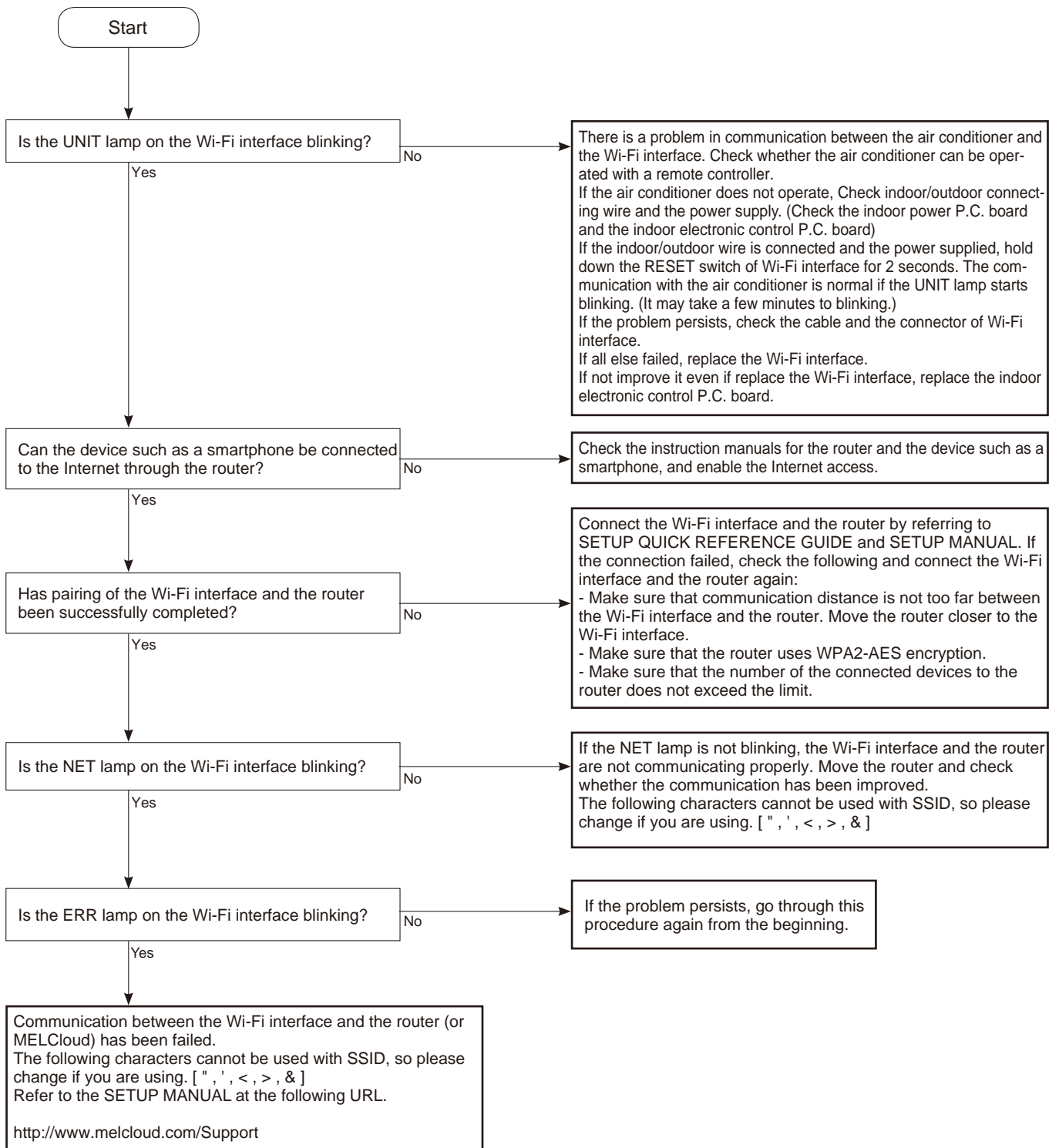















































































10-4. TROUBLESHOOTING CHECK TABLE

Before taking measures, make sure that the symptom reappears for accurate troubleshooting.
When the indoor unit has started operation and detected an abnormality of the following condition (the first detection after the power ON), the indoor fan motor turns OFF and OPERATION INDICATOR lamp blinks.

OPERATION INDICATOR



-  Lit
-  Blinking
-  Not lit

No.	Abnormal point	Operation indicator lamp	Symptom	Condition	Remedy
1	Miswiring or serial signal	Left lamp blinks. 0.5-second ON     0.5-second OFF	Indoor unit and outdoor unit do not operate.	The serial signal from the outdoor unit is not received for 6 minutes. The indoor unit is connected to a low-standby-power model after once connected to a non-low-standby-power model.	<ul style="list-style-type: none"> Refer to 10-6. ④ "How to check miswiring and serial signal error". Refer to NOTE.
2	Indoor coil thermistor Room temperature thermistor	Left lamp blinks. 2-time blink        2.5-second OFF		The indoor coil or the room temperature thermistor is short or open circuit.	<ul style="list-style-type: none"> Refer to the characteristics of indoor coil thermistor, and the room temperature thermistor (10-7.).
3	Indoor fan motor	Left lamp blinks. 3-time blink          2.5-second OFF		The rotational frequency feedback signal is not emitted during the indoor fan operation.	<ul style="list-style-type: none"> Refer to 10-6. ⑤ "Check of indoor fan motor".
4	Indoor control system	Left lamp blinks. 4-time blink          2.5-second OFF		It cannot properly read data in the nonvolatile memory of the indoor electronic control P.C. board.	<ul style="list-style-type: none"> Replace the indoor electronic control P.C. board.
5	Outdoor power system	Left lamp blinks. 5-time blink          2.5-second OFF		It consecutively occurs 3 times that the compressor stops for overcurrent protection or start-up failure protection within 1 minute after start-up.	<ul style="list-style-type: none"> Refer to "How to check of inverter/compressor". Refer to outdoor unit service manual Check the stop valve.
6	Outdoor thermistors	Left lamp blinks. 6-time blink          2.5-second OFF		The outdoor thermistors short or open circuit during the compressor operation.	<ul style="list-style-type: none"> Refer to "Check of outdoor thermistor". Refer to outdoor unit service manual.
7	Outdoor control system	Left lamp blinks. 7-time blink          2.5-second OFF		It cannot properly read data in the nonvolatile memory of the inverter P.C. board or the outdoor electronic control P.C. board.	<ul style="list-style-type: none"> Replace the inverter P.C. board or the outdoor electronic control P.C. board. Refer to outdoor unit service manual.
8	Other abnormality	Left lamp blinks. 14-time blink or more                   2.5-second OFF		An abnormality other than above mentioned is detected.	<ul style="list-style-type: none"> Check the stop valve. Check the 4-way valve. Confirm the abnormality in detail using the failure mode recall function for outdoor unit.
9	Outdoor control system	Left lamp lights up 	Outdoor unit does not operate	It cannot properly read data in the nonvolatile memory of the inverter P.C. board or the outdoor electronic control P.C. board.	<ul style="list-style-type: none"> Check the blinking pattern of the LED on the inverter P.C. board or the outdoor electronic control P.C. board.

NOTE: The indoor unit may have been connected to a non-low-standby-power model outdoor unit. To use a low-standby-power model, clear the error history by referring to "Deleting the memorized abnormal condition" described in 10-2.1. When the error history is being cleared, the connection information also will be initialized. The indoor unit will be compatible with a low-standby-power model after initialization. If the operation indicator lamp continues to blink as shown in No.1 after the procedure, refer to 10-6. ④ "How to check miswiring and serial error".

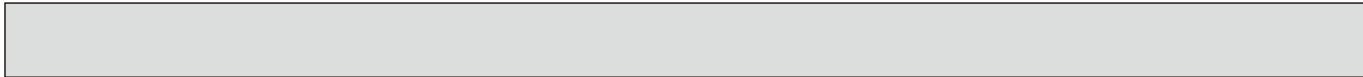

OPERATION INDICATOR



No.	Abnormal point	Operation indicator lamp	Symptom	Condition	Remedy
1	MXZ type Operation mode setting	Left lamp lights and lower lamp blinks. 	Outdoor unit operates but indoor unit does not operate.	The operation mode of the each indoor unit is differently set to COOL (includes DRY) and HEAT at the same time, the operation mode of the indoor unit that has operated at first has the priority.	<ul style="list-style-type: none"> Unify the operation mode. Refer to outdoor unit service manual.

10-5. TROUBLE CRITERION OF MAIN PARTS

- MSZ-EF18VGW MSZ-EF22VGW MSZ-EF25VGW MSZ-EF35VGW MSZ-EF42VGW MSZ-EF50VGW**
MSZ-EF18VGB MSZ-EF22VGB MSZ-EF25VGB MSZ-EF35VGB MSZ-EF42VGB MSZ-EF50VGB
MSZ-EF18VGS MSZ-EF22VGS MSZ-EF25VGS MSZ-EF35VGS MSZ-EF42VGS MSZ-EF50VGS
MSZ-EF18VGKW MSZ-EF22VGKW MSZ-EF25VGKW MSZ-EF35VGKW MSZ-EF42VGKW MSZ-EF50VGKW
MSZ-EF18VGKB MSZ-EF22VGKB MSZ-EF25VGKB MSZ-EF35VGKB MSZ-EF42VGKB MSZ-EF50VGKB
MSZ-EF18VGKS MSZ-EF22VGKS MSZ-EF25VGKS MSZ-EF35VGKS MSZ-EF42VGKS MSZ-EF50VGKS

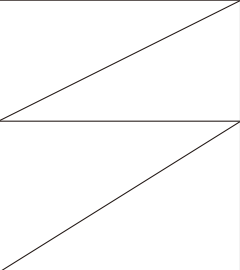
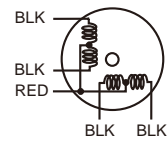
Part name	Check method and criterion	Figure				
Room temperature thermistor (RT11) Indoor coil thermistor (RT12, RT13)	Measure the resistance with a tester. Refer to 10-7. "Test point diagram and voltage", "Indoor electronic control P.C. board", for the chart of thermistor.					
Indoor fan motor (MF)	Check 10-6.Ⓐ "Check of indoor fan motor".					
Vane motor (MV)	Measure the resistance between the terminals with a tester. (Temperature: 10 - 30°C) <table border="1" data-bbox="462 1321 1117 1388"> <thead> <tr> <th>Color of the lead wire</th> <th>Normal</th> </tr> </thead> <tbody> <tr> <td>RED - BLK</td> <td>232 - 268 Ω</td> </tr> </tbody> </table>	Color of the lead wire	Normal	RED - BLK	232 - 268 Ω	
Color of the lead wire	Normal					
RED - BLK	232 - 268 Ω					

10-6. TROUBLESHOOTING FLOW

A Check of indoor fan motor

The indoor fan motor error has occurred, and the indoor fan does not operate.

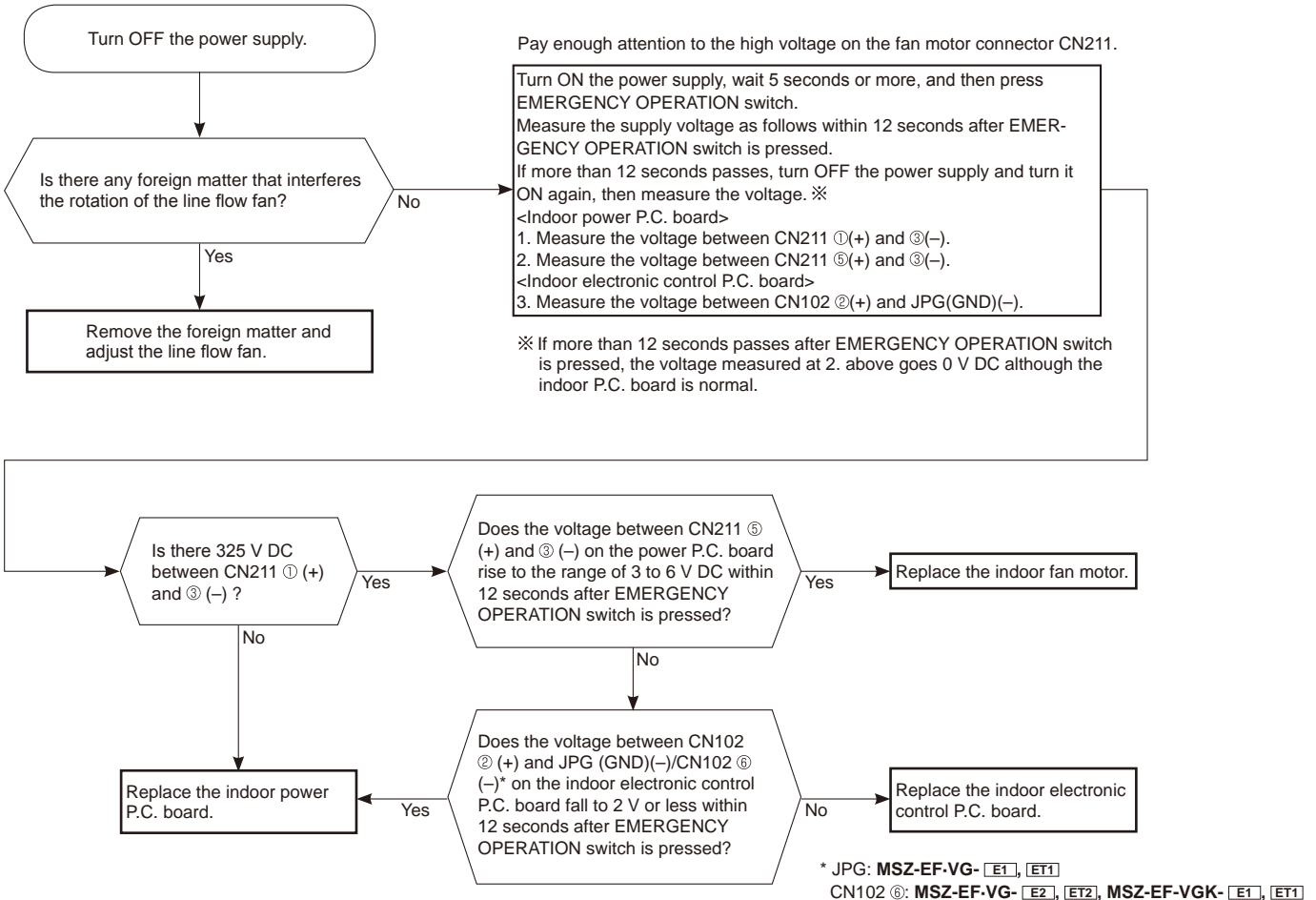

The indoor fan motor error has occurred, and the indoor fan repeats "12-second ON and 30-second OFF" 3 times, and then stops.

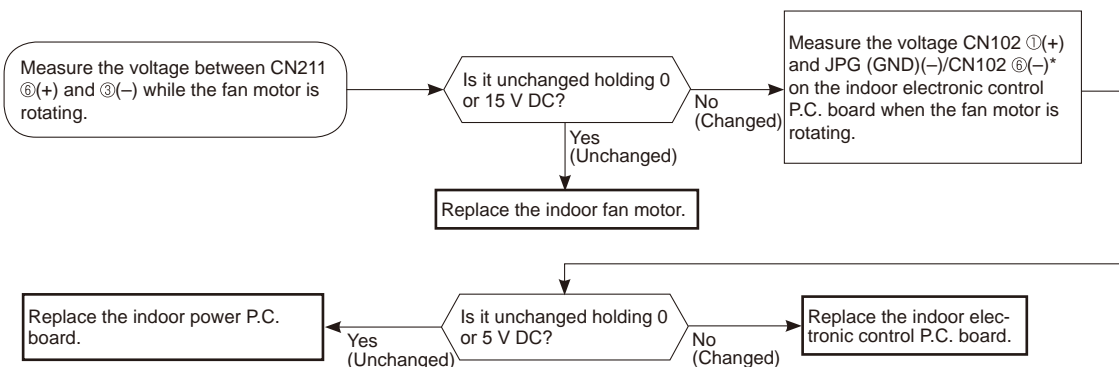

B Check of remote controller and indoor electronic control P.C. board

※Check if the remote controller is exclusive for this air conditioner.

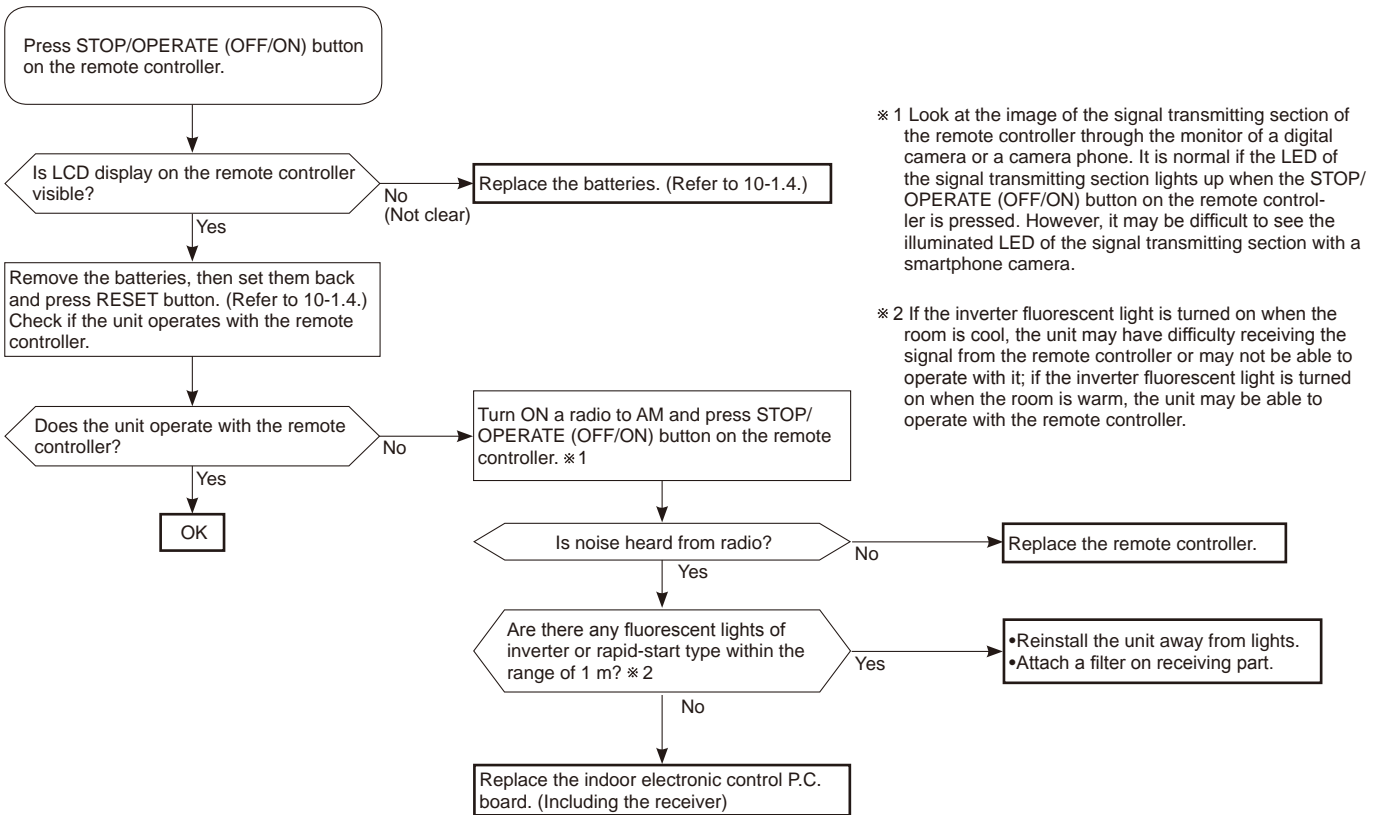

© Check of indoor P.C. board and indoor fan motor

MSZ-EF-VG- [ET], [ET1]

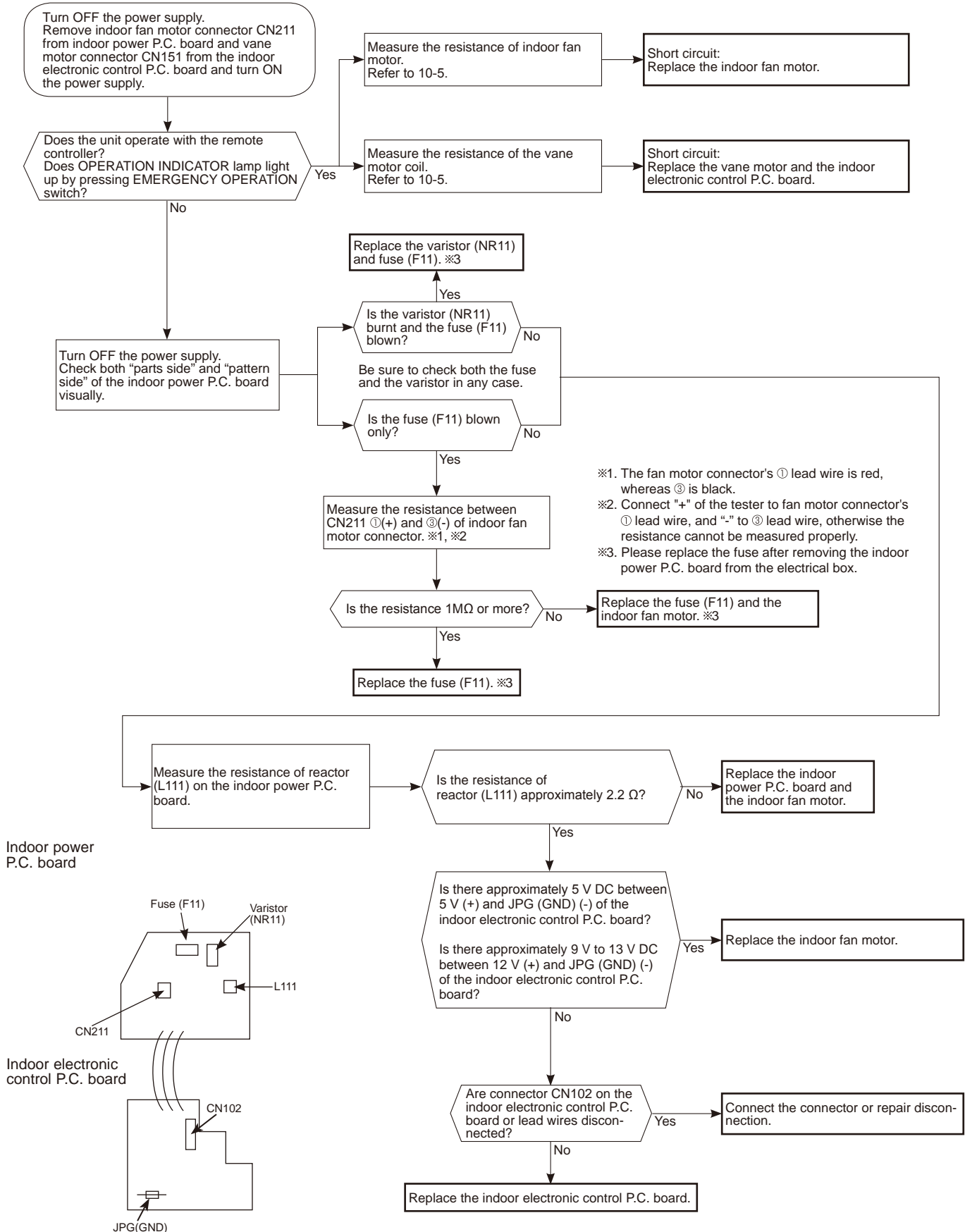

MSZ-EF18/22/25/35/42VG- [E2], [ET2]
MSZ-EF18/22/25/35/42VGK- [E1], [ET1]

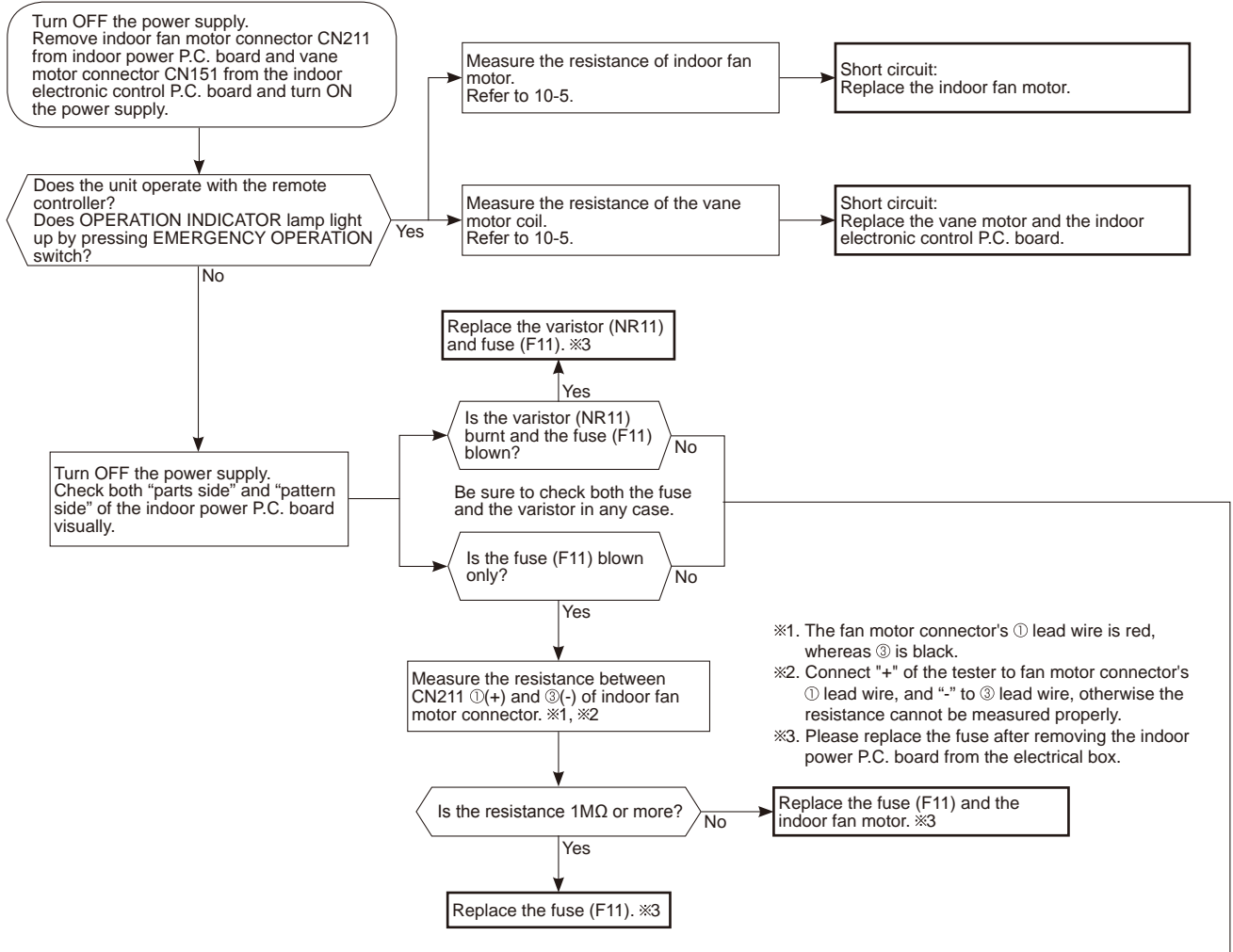

- ※1. The fan motor connector's ① lead wire is red, whereas ③ is black.
- ※2. Connect "+" of the tester to fan motor connector's ① lead wire, and "-" to ③ lead wire, otherwise the resistance cannot be measured properly.
- ※3. Please replace the fuse after removing the indoor power P.C. board from the electrical box.

Indoor power P.C. board

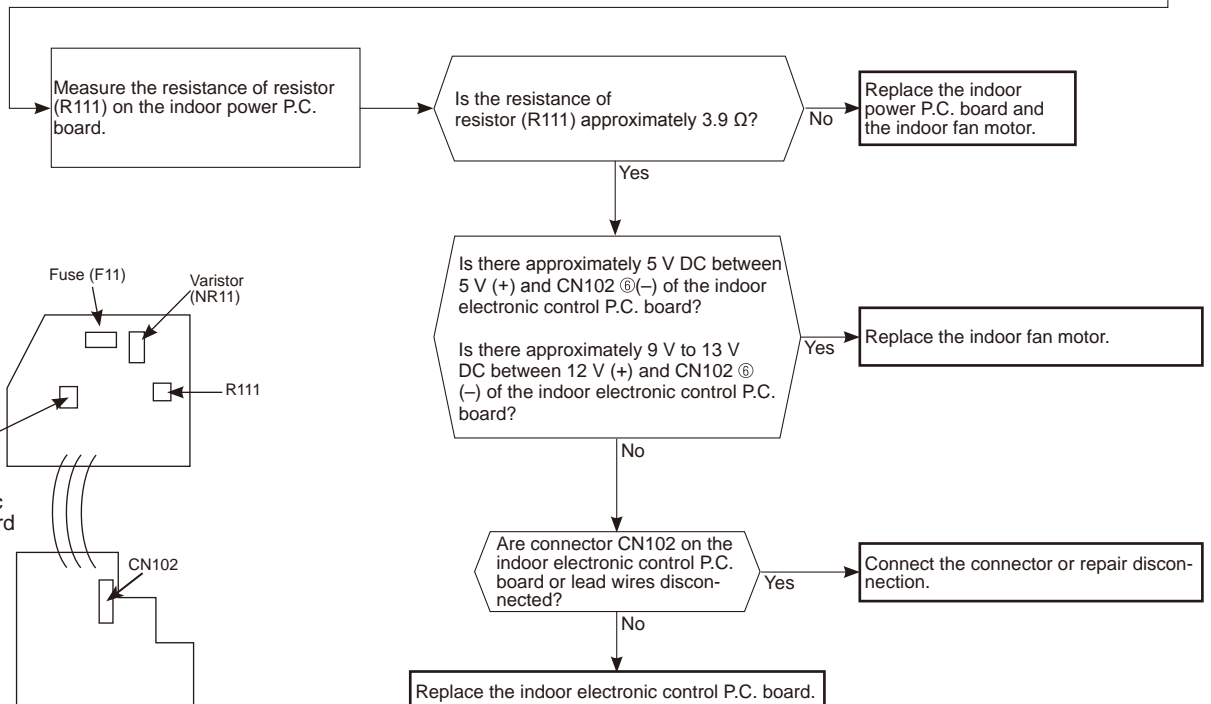
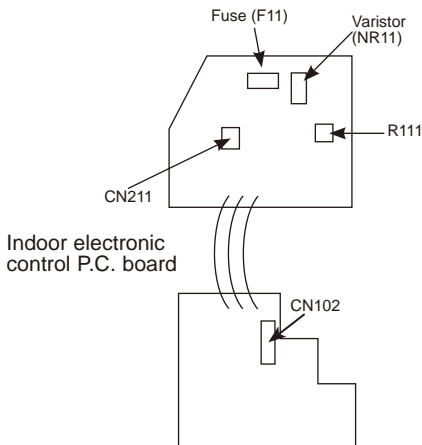

MSZ-EF50VG- [E2], [ET2]
MSZ-EF50VGK- [E1], [ET1]

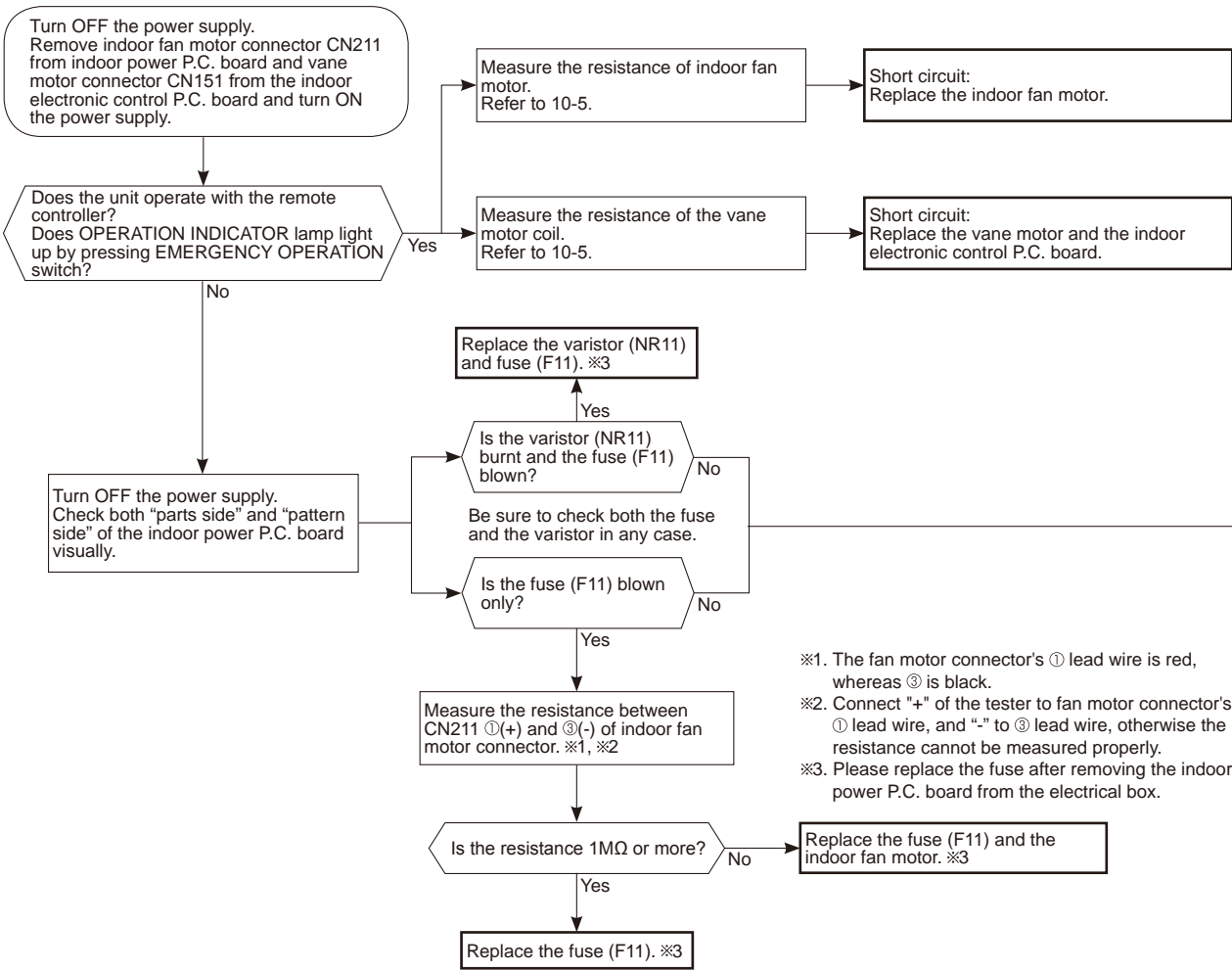

- ※1. The fan motor connector's ① lead wire is red, whereas ③ is black.
- ※2. Connect "+" of the tester to fan motor connector's ① lead wire, and "-" to ③ lead wire, otherwise the resistance cannot be measured properly.
- ※3. Please replace the fuse after removing the indoor power P.C. board from the electrical box.

Indoor power P.C. board

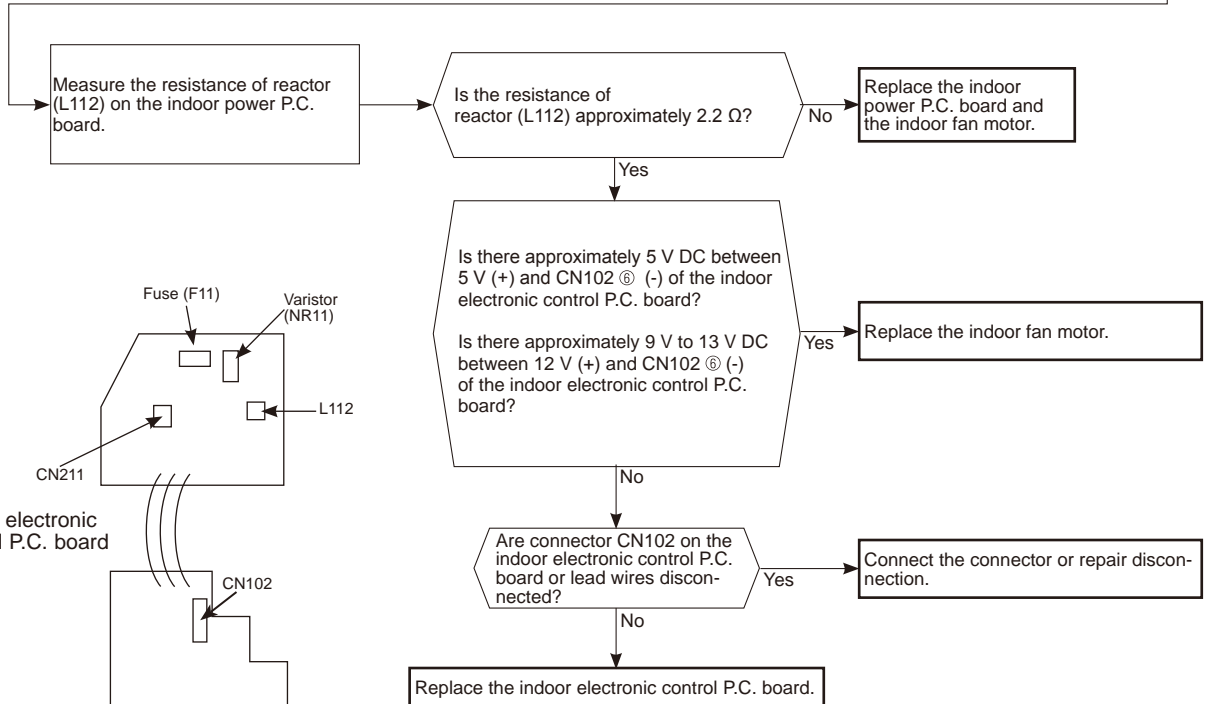
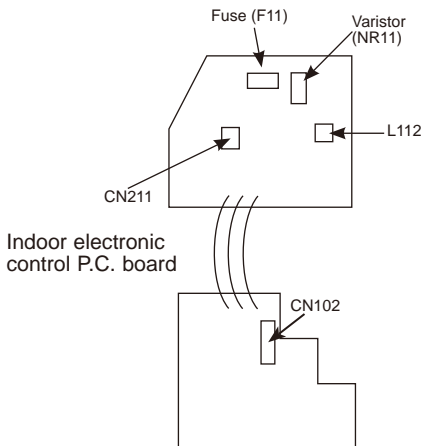

D How to check miswiring and serial signal error

MUZ-EF Type

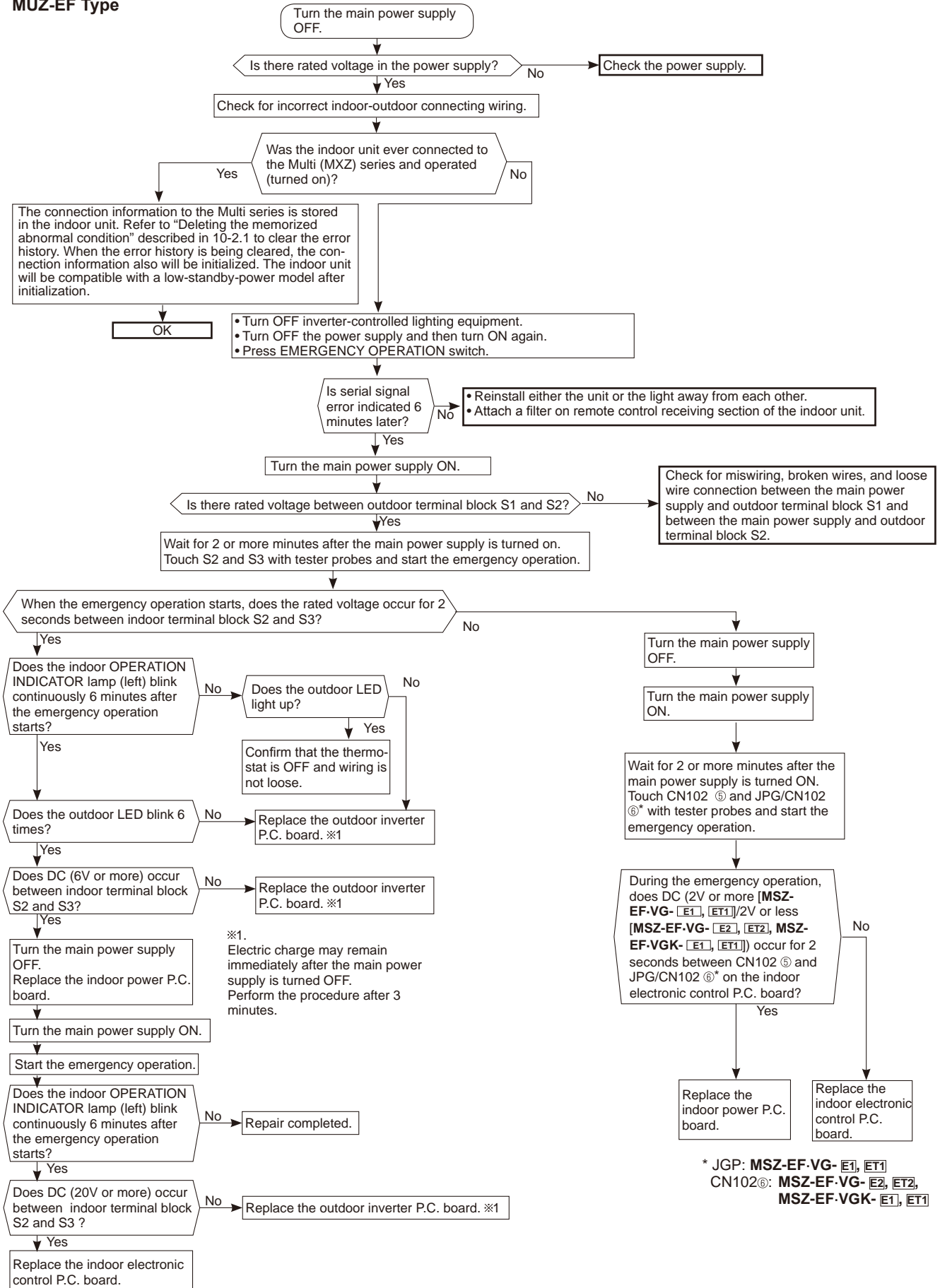

MXZ Type

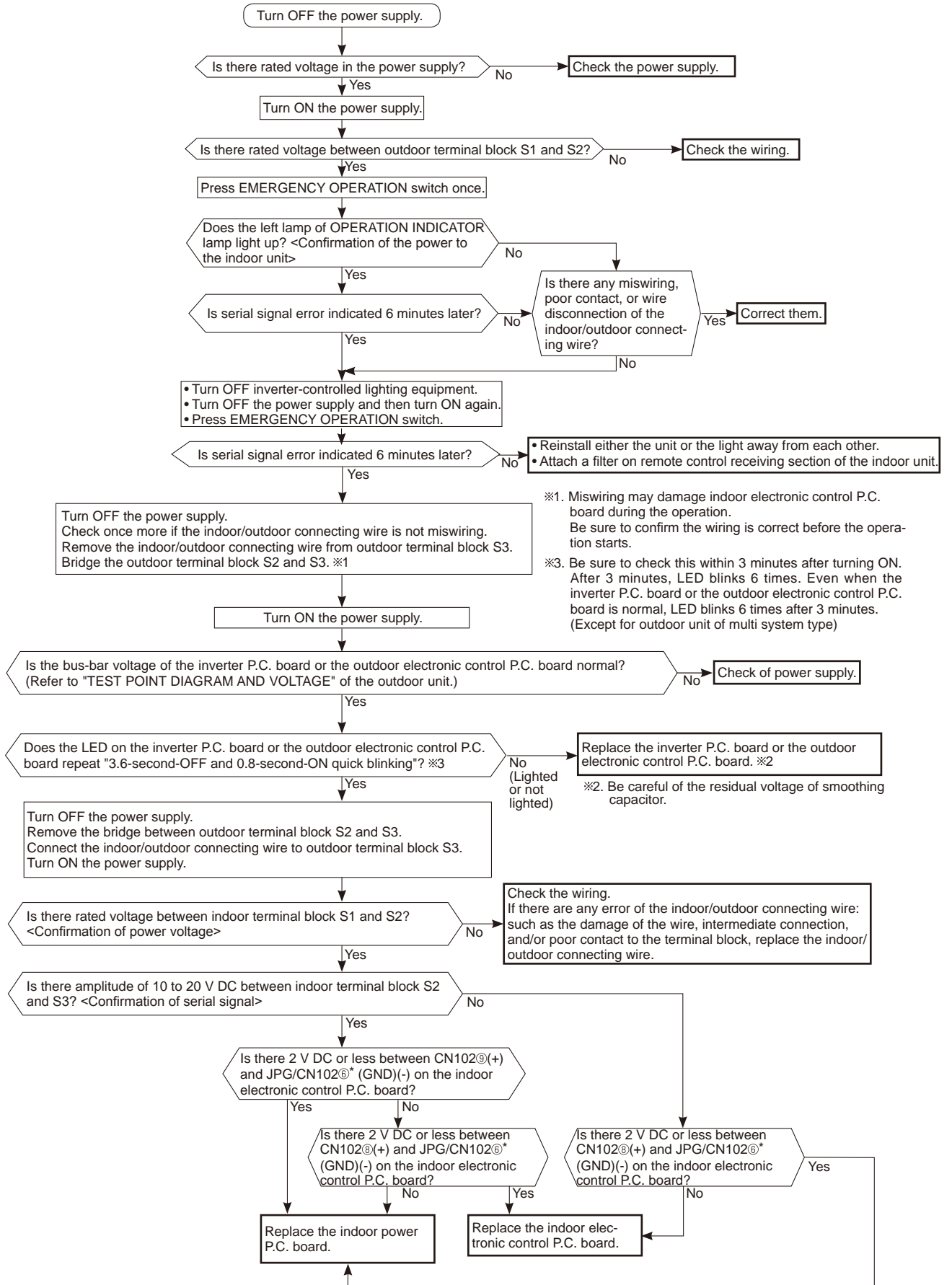

※1. Miswiring may damage indoor electronic control P.C. board during the operation. Be sure to confirm the wiring is correct before the operation starts.

※2. Be careful of the residual voltage of smoothing capacitor.

※3. Be sure to check this within 3 minutes after turning ON. After 3 minutes, LED blinks 6 times. Even when the inverter P.C. board or the outdoor electronic control P.C. board is normal, LED blinks 6 times after 3 minutes. (Except for outdoor unit of multi system type)

* JGP: MSZ-EF-VG- E1, ET1
CN102Ⓢ: MSZ-EF-VG- E2, ET2, MSZ-EF-VGK- E1, ET1

E Electromagnetic noise enters into TV sets or radios

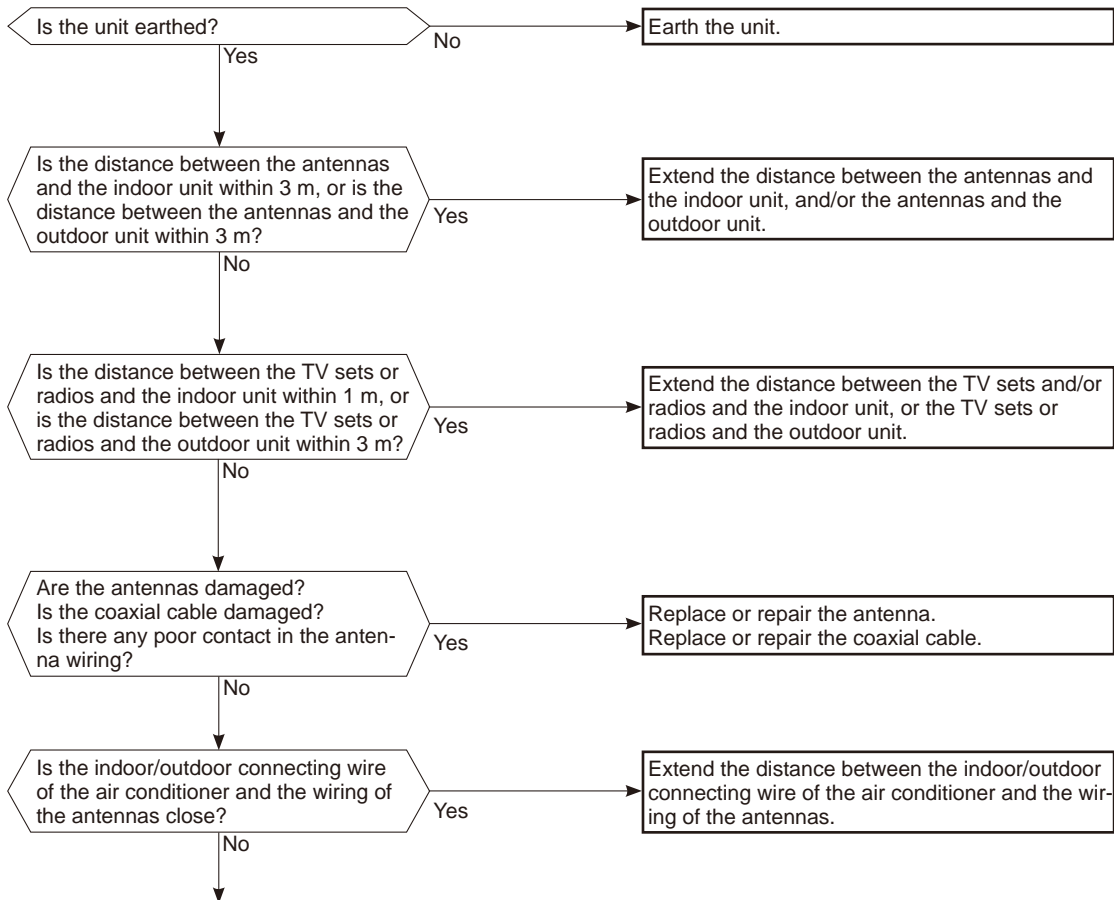

Even if all of the above conditions are fulfilled, the electromagnetic noise may enter, depending on the electric field strength or the installation condition (combination of specific conditions such as antennas or wiring).

Check the following before asking for service.

1. Devices affected by the electromagnetic noise
TV sets, radios (FM/AM broadcast, shortwave)
2. Channel, frequency, broadcast station affected by the electromagnetic noise
3. Channel, frequency, broadcast station unaffected by the electromagnetic noise
4. Layout of:
indoor/outdoor unit of the air conditioner, indoor/outdoor wiring, earth wire, antennas, wiring from antennas, receiver
5. Electric field intensity of the broadcast station affected by the electromagnetic noise
6. Presence or absence of amplifier such as booster
7. Operation condition of air conditioner when the electromagnetic noise enters in
 - 1) Turn OFF the power supply once, and then turn ON the power supply. In this situation, check for the electromagnetic noise.
 - 2) Within 3 minutes after turning ON the power supply, press STOP/OPERATE (OFF/ON) button on the remote controller for power ON, and check for the electromagnetic noise.
 - 3) After a short time (3 minutes later after turning ON), the outdoor unit starts running. During operation, check for the electromagnetic noise.
 - 4) Press STOP/OPERATE (OFF/ON) button on the remote controller for power OFF, when the outdoor unit stops but the indoor/outdoor communication still runs on. In this situation, check for the electromagnetic noise.

10-7. TEST POINT DIAGRAM AND VOLTAGE

1. Indoor electronic control P.C. board, indoor power P.C. board, receiver P.C. board and display P.C. board

MSZ-EF18VGW-E1	MSZ-EF22VGW-E1, ET1	MSZ-EF25VGW-E1, ET1	MSZ-EF35VGW-E1, ET1	MSZ-EF42VGW-E1, ET1	MSZ-EF50VGW-E1, ET1
MSZ-EF18VGB-E1	MSZ-EF22VGB-E1, ET1	MSZ-EF25VGB-E1, ET1	MSZ-EF35VGB-E1, ET1	MSZ-EF42VGB-E1, ET1	MSZ-EF50VGB-E1, ET1
MSZ-EF18VGS-E1	MSZ-EF22VGS-E1, ET1	MSZ-EF25VGS-E1, ET1	MSZ-EF35VGS-E1, ET1	MSZ-EF42VGS-E1, ET1	MSZ-EF50VGS-E1, ET1

Indoor power P.C. board

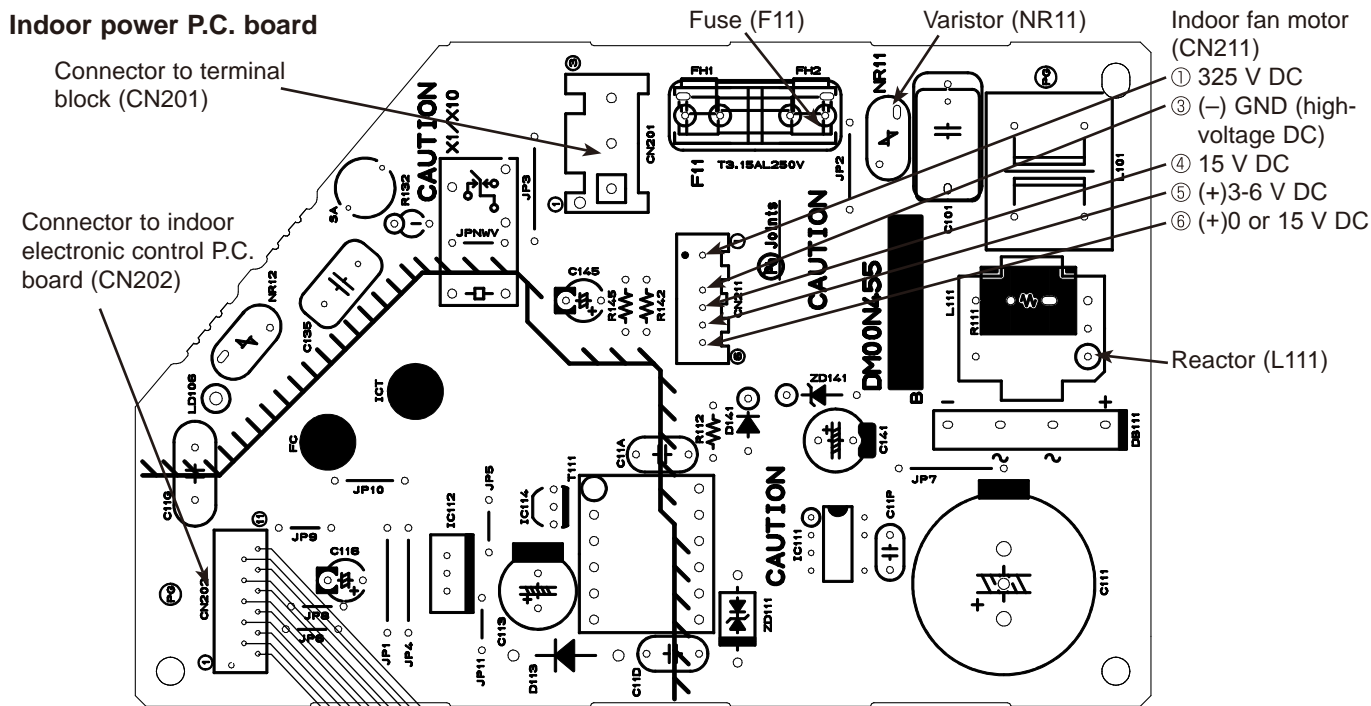

Indoor electronic control P.C. board

Receiver P.C. board

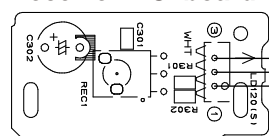

Room temperature thermistor (RT11) Indoor coil thermistor (RT12, RT13)

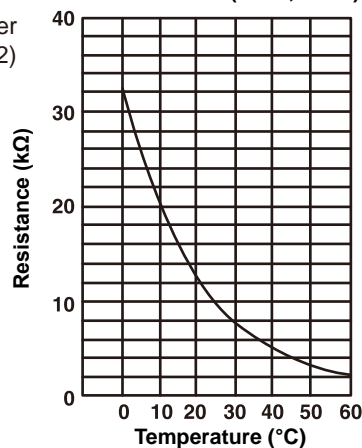

Vane motor (CN151)

Display P.C. board

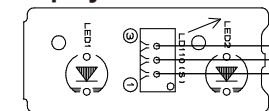

Room temperature thermistor RT11 (CN111)

Switch P.C. board

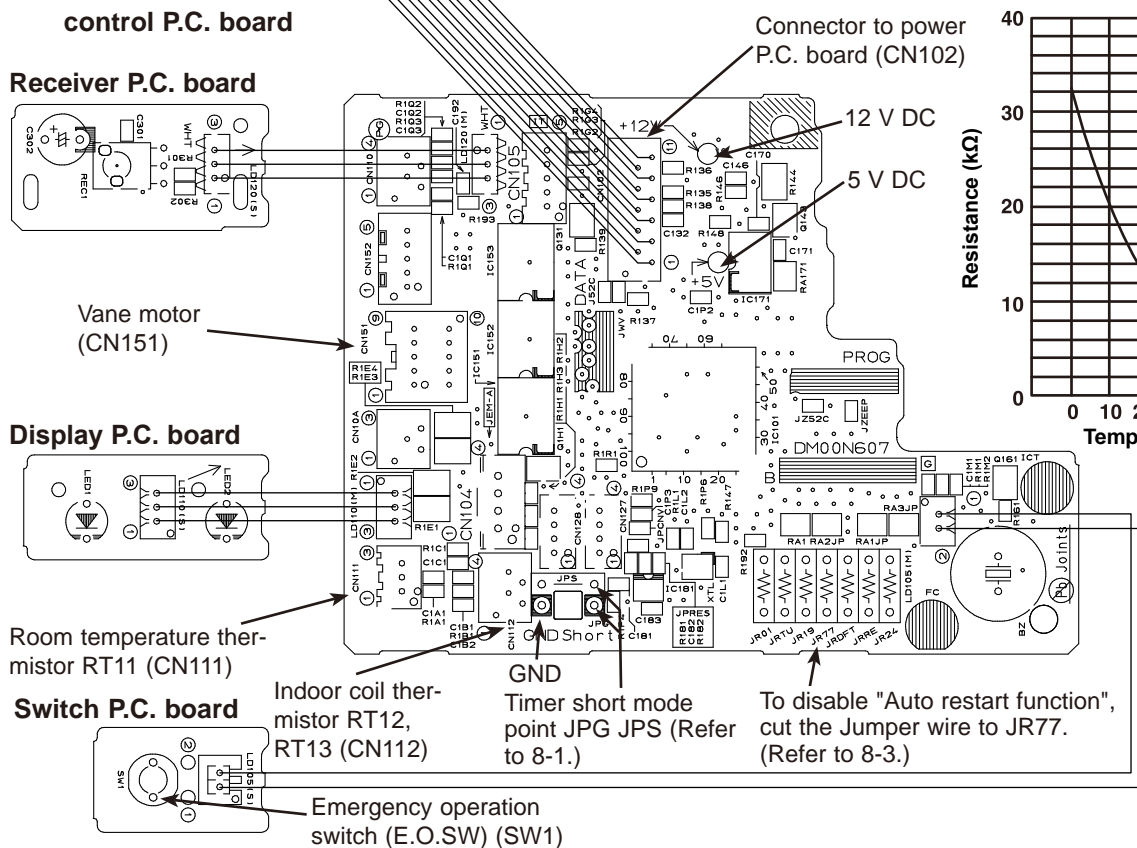
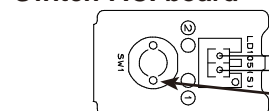

MSZ-EF18VGW- [E2]	MSZ-EF22VGW- [E2,ET2]	MSZ-EF25VGW- [E2,ET2]	MSZ-EF35VGW- [E2,ET2]	MSZ-EF42VGW- [E2,ET2]	MSZ-EF50VGW- [E2,ET2]
MSZ-EF18VGB- [E2]	MSZ-EF22VGB- [E2,ET2]	MSZ-EF25VGB- [E2,ET2]	MSZ-EF35VGB- [E2,ET2]	MSZ-EF42VGB- [E2,ET2]	MSZ-EF50VGB- [E2,ET2]
MSZ-EF18VGS- [E2]	MSZ-EF22VGS- [E2,ET2]	MSZ-EF25VGS- [E2,ET2]	MSZ-EF35VGS- [E2,ET2]	MSZ-EF42VGS- [E2,ET2]	MSZ-EF50VGS- [E2,ET2]
MSZ-EF18VGKW- [E1,ET1]	MSZ-EF22VGKW- [E1,ET1]	MSZ-EF25VGKW- [E1,ET1]	MSZ-EF35VGKW- [E1,ET1]	MSZ-EF42VGKW- [E1,ET1]	MSZ-EF50VGKW- [E1,ET1]
MSZ-EF18VGBK- [E1,ET1]	MSZ-EF22VGBK- [E1,ET1]	MSZ-EF25VGBK- [E1,ET1]	MSZ-EF35VGBK- [E1,ET1]	MSZ-EF42VGBK- [E1,ET1]	MSZ-EF50VGBK- [E1,ET1]
MSZ-EF18VGSK- [E1,ET1]	MSZ-EF22VGSK- [E1,ET1]	MSZ-EF25VGSK- [E1,ET1]	MSZ-EF35VGSK- [E1,ET1]	MSZ-EF42VGSK- [E1,ET1]	MSZ-EF50VGSK- [E1,ET1]

Indoor power P.C. board

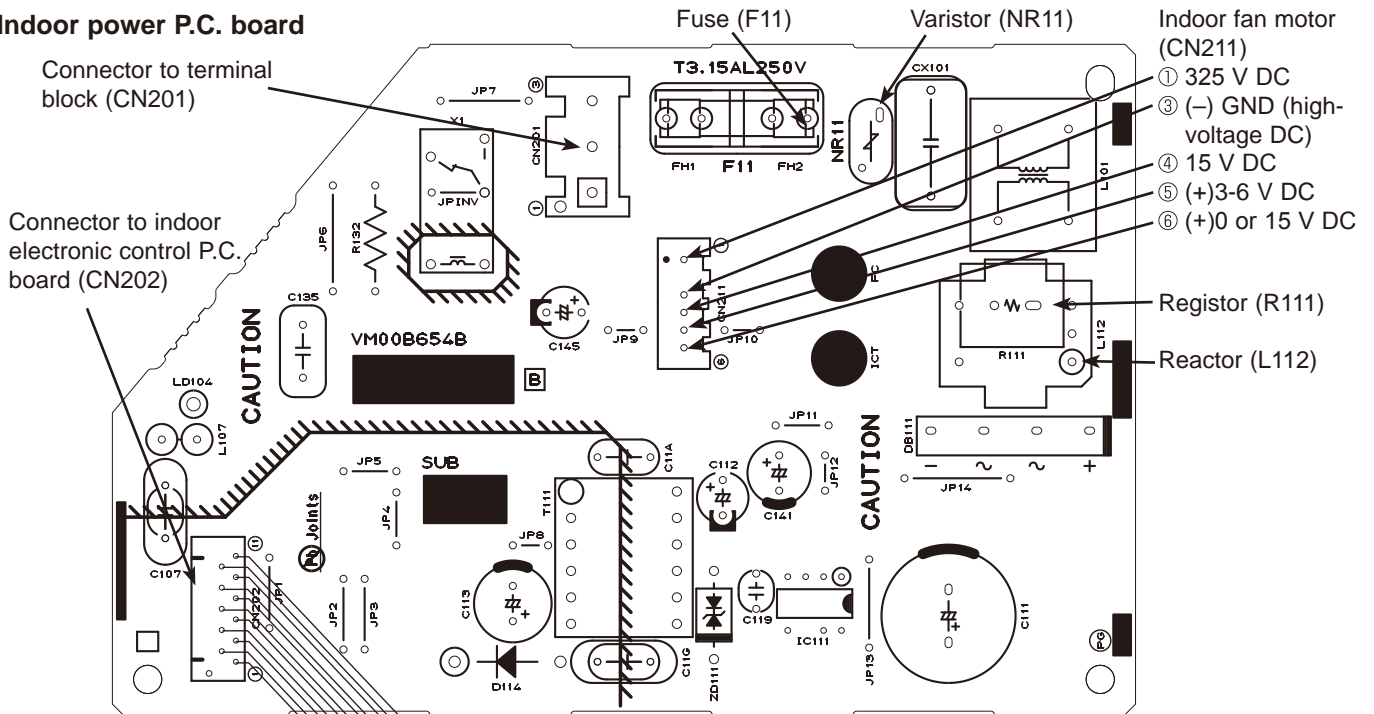

Indoor electronic control P.C. board

Receiver P.C. board

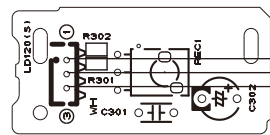

Wi-Fi interface connector (CN110)

Vane motor (CN151)

Display P.C. board

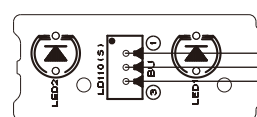

Room temperature thermistor RT11 (CN111)

Switch P.C. board

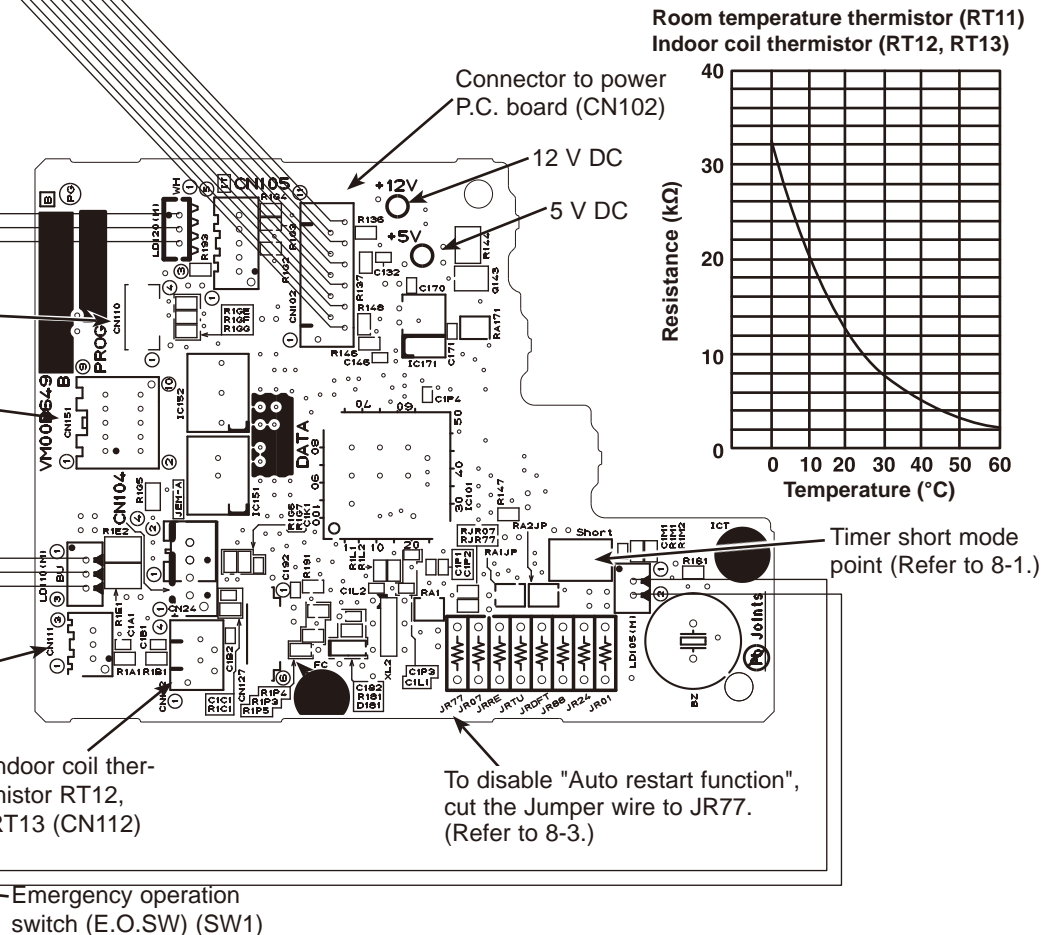
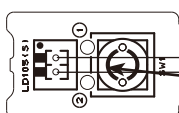

Room temperature thermistor (RT11)
 Indoor coil thermistor (RT12, RT13)

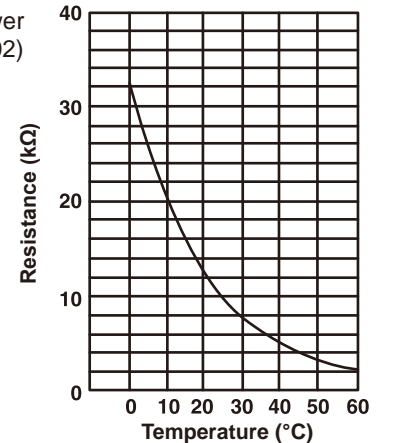

<Detaching method of the terminal with lockig mechanism>

The terminal which has the locking mechanism can be detached as shown below.

There are 2 types of the terminals with locking mechanisms.

The terminal without locking mechanism can be detached by pulling it out.

Check the shape of the terminal before detaching.

(1) Slide the sleeve and check if there is a locking lever or not.

(2) The terminal with this connector shown below has the locking mechanism.

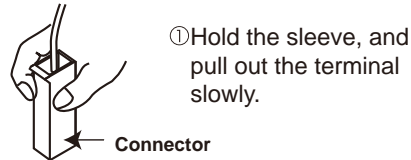
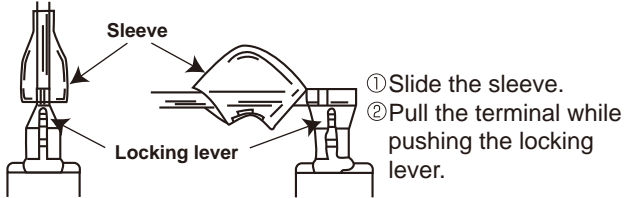

- 11-1. MSZ-EF18VGW MSZ-EF22VGW MSZ-EF25VGW MSZ-EF35VGW MSZ-EF42VGW MSZ-EF50VGW
 MSZ-EF18VGB MSZ-EF22VGB MSZ-EF25VGB MSZ-EF35VGB MSZ-EF42VGB MSZ-EF50VGB
 MSZ-EF18VGS MSZ-EF22VGS MSZ-EF25VGS MSZ-EF35VGS MSZ-EF42VGS MSZ-EF50VGS

NOTE: Turn OFF the power supply before disassembly.

—————>: Indicates the visible parts in the photos/figures.
 - - - - ->: Indicates the invisible parts in the photos/figures.

OPERATING PROCEDURE	PHOTOS/FIGURES
<p>1. Removing the panel</p> <p>(1) Remove the horizontal vanes.</p> <p>(2) Remove the screw caps of the panel. Remove the screws of the panel.</p> <p>(3) Unhook the lower part (A) of the panel.</p> <p>(4) First, hold the lower part of the right end of the panel, and hold the lower part of the left end of the panel.</p> <p>(5) Pull the panel slightly toward you, and then remove the panel by pushing it upward.</p>	<p>Photo 1</p> <p>Front panel Horizontal vanes</p> <p>Screws of the panel</p>

OPERATING PROCEDURE

2. Remove the indoor electrical box

- (1) Remove the panel (Refer to section 1.) and the corner box right.
- (2) Remove the screw of the V.A. clamp. Remove the V.A. clamp and the indoor/outdoor connecting wire.
- (3) Remove the earth wire connected to the indoor heat exchanger from the electrical box.
- (4) Remove the screw of the electrical cover and remove the electrical cover.
- (5) Disconnect following connectors:
<Indoor electronic control P.C. board>
CN151 (Vane motor)
<Indoor power P.C. board>
CN211 (Indoor fan motor)
- (6) Remove the screw fixing the electrical box, then the upper catch of the electrical box, and pull out the electrical box.

3. Removing the indoor power P.C. board, the switch board, the display board, the receiver board and the indoor electronic control P.C. board

- (1) Remove the panel (Refer to section 1.) and the corner box right.
- (2) Remove the screw of the V.A. clamp. Remove the V.A. clamp and the indoor/outdoor connecting wire.
- (3) Remove the indoor electrical box (Refer to section 2.).
- (4) Remove the earth wire connected to the electrical box from the indoor power P.C. board.
- (5) Disconnect the following connectors:
<Indoor electronic power P.C. board>
CN201 (Terminal block)
CN202 (To the indoor electronic control P.C. board)
- (6) Remove the indoor power P.C. board.
- (7) Disconnect the following connectors:
<Indoor electronic control P.C. board>
CN111 (Room temperature thermistor)
CN112 (Indoor coil thermistor)
- (8) Unhook the catches of the display P.C. board holder from the nozzle and the electrical box (right side).
- (9) Open the rear cover of the display P.C. board holder and remove the switch board, the display board and the receiver board.
Remove the indoor electronic control P.C. board.

PHOTOS/FIGURES

Photo 2

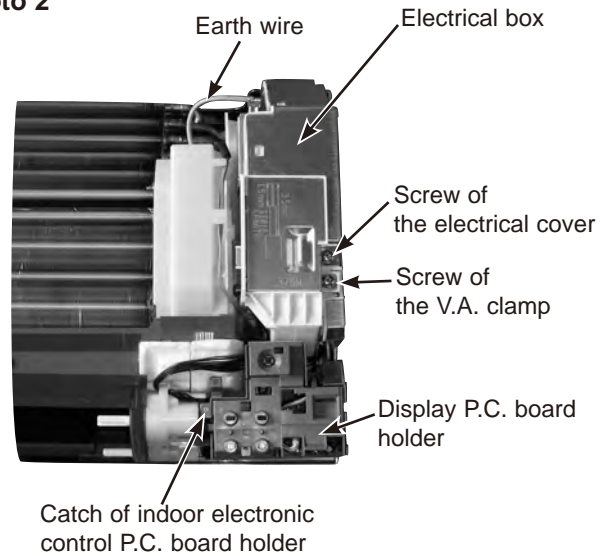
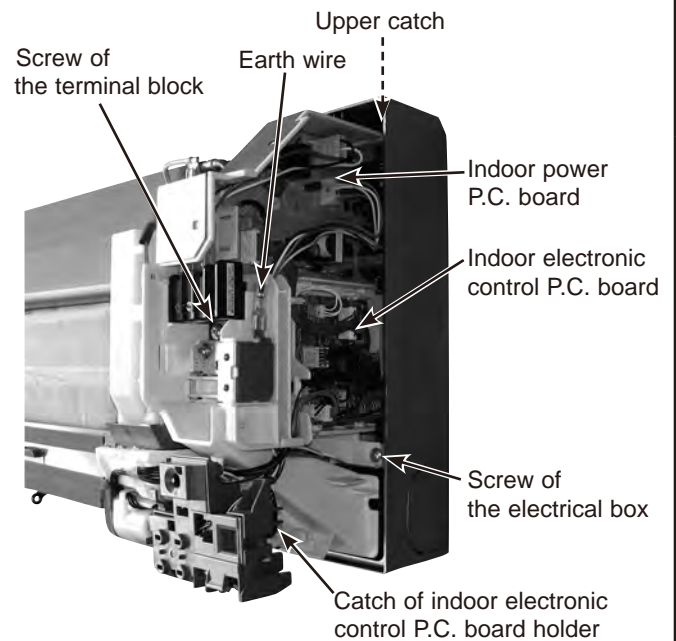

Photo 3





OPERATING PROCEDURE

4. Removing the nozzle assembly

- (1) Remove the panel (Refer to section 1.) and the corner box right.
- (2) Remove the indoor/outdoor connecting wire (Refer to section 2.).
- (3) Remove the electrical cover (Refer to section 2.).
- (4) Disconnect the following connector:
<Indoor electronic control P.C. board>
CN151 (Vane motor)
- (5) Remove the display P.C. board holder.
- (6) Pull out the drain hose from the nozzle assembly and remove the nozzle assembly.
- (7) Remove the vane motors (Refer to section 5.).

5. Removing the horizontal vane motor

- (1) Remove the nozzle assembly (Refer to section 4.).
- (2) Remove the screws of the vane motor unit cover, and pull out the vane motor unit
- (3) Remove the screws of the vane motor unit.
- (4) Disconnect the connector from the vane motor.
- (5) Remove the vane motor from the vane motor unit.

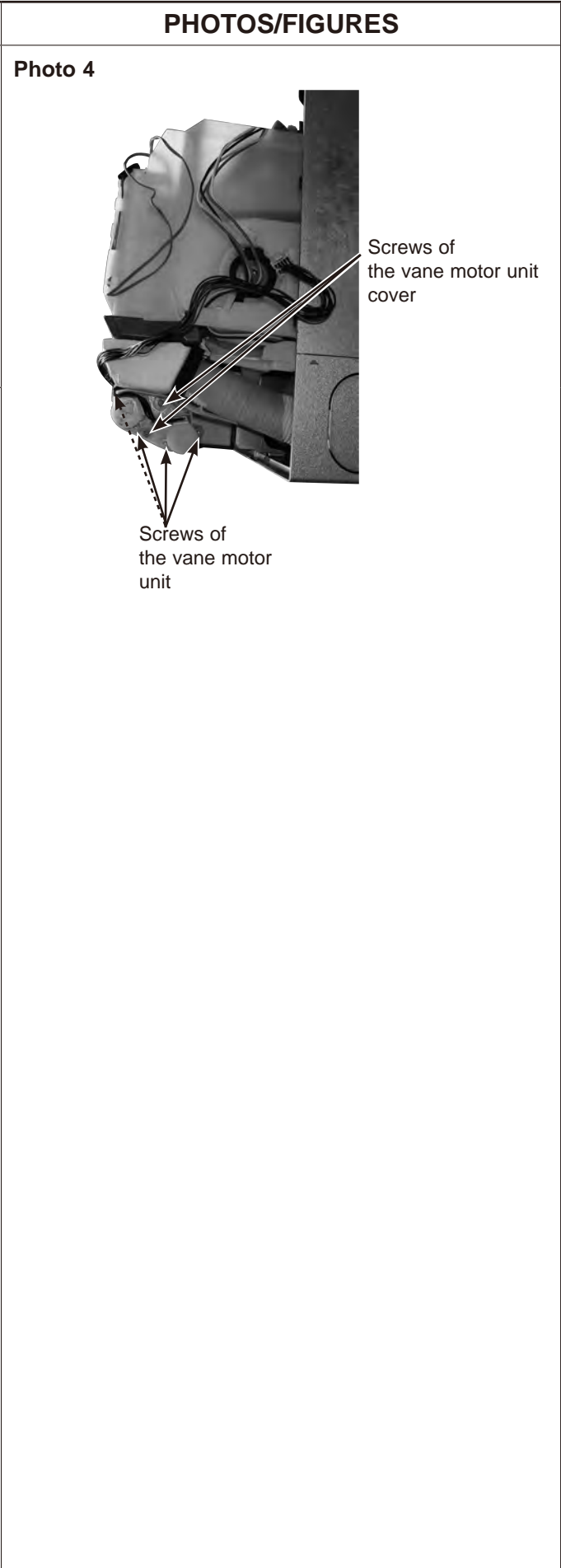

OPERATING PROCEDURE

6. Removing the indoor fan motor, the indoor coil thermistor and the line flow fan

- (1) Remove the panel (Refer to section 1.) and the corner box right.
 - (2) Remove the indoor electronic control P.C. board holder, the electrical box and the nozzle assembly.
 - (3) Remove the screws fixing the motor bed.
 - (4) Release the hooks of the water cut and remove the water cut.
 - (5) Loosen the screw fixing the line flow fan.
 - (6) Remove the motor bed together with the indoor fan motor and the motor band.
 - (7) Release the hooks of the motor band and remove the motor band. Pull out the indoor fan motor.
 - (8) Remove the indoor coil thermistor from the heat exchanger.
- ※ Install the indoor coil thermistor in its former position when assembling it (Photo 5).
- (9) Remove the screws fixing the left side and the upper right side of the heat exchanger (Photo 7, Photo 8).
 - (10) Lift the heat exchanger, and pull out the line flow fan to the lower-left.

- ※ When attaching the line flow fan, screw the line flow fan so 4 mm gap is provided between the right end of the line flow fan and the right wall of the air passage of the box (Figure 1).

Figure 1

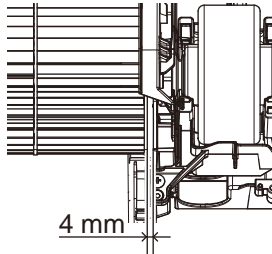
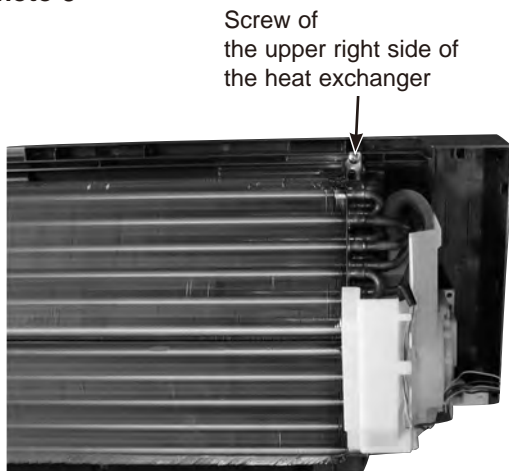

Photo 8



PHOTOS/FIGURES

Photo 5

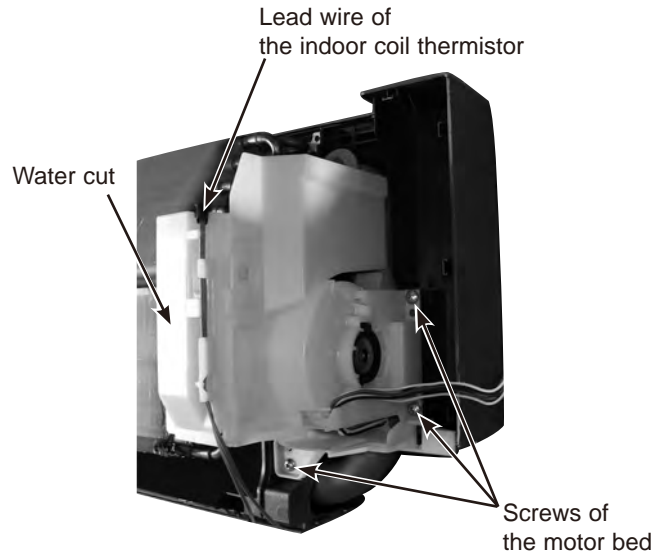

Photo 6

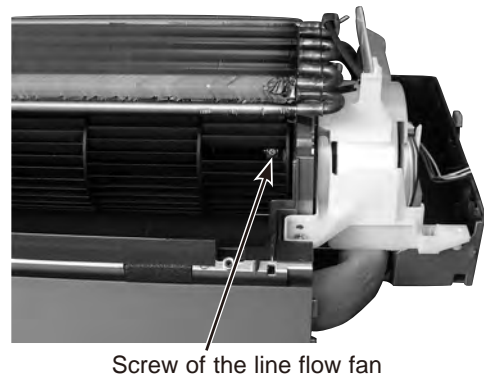
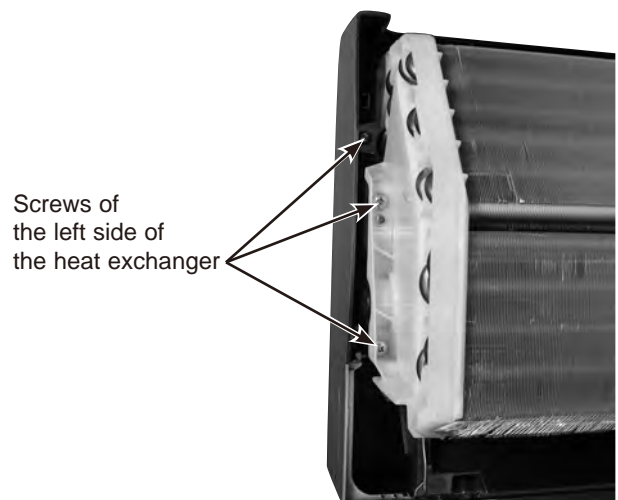

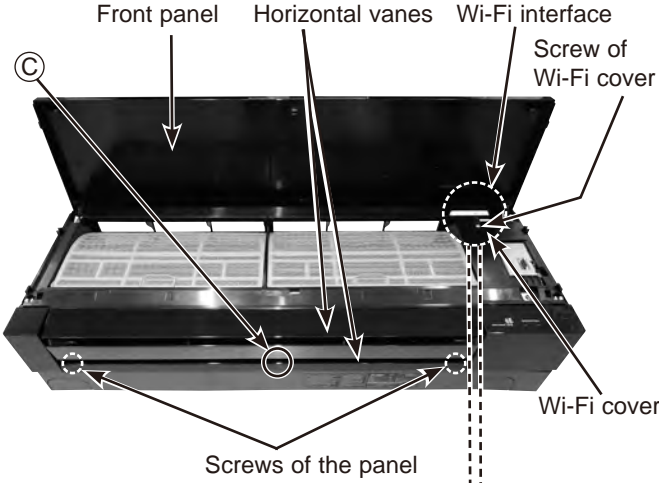

Photo 7



**11-2. MSZ-EF18VGKW MSZ-EF22VGKW MSZ-EF25VGKW MSZ-EF35VGKW MSZ-EF42VGKW MSZ-EF50VGKW
 MSZ-EF18VGKB MSZ-EF22VGKB MSZ-EF25VGKB MSZ-EF35VGKB MSZ-EF42VGKB MSZ-EF50VGKB
 MSZ-EF18VGKS MSZ-EF22VGKS MSZ-EF25VGKS MSZ-EF35VGKS MSZ-EF42VGKS MSZ-EF50VGKS**

NOTE: Turn OFF the power supply before disassembly.

—————> : Indicates the visible parts in the photos/figures.
 - - - - -> : Indicates the invisible parts in the photos/figures.

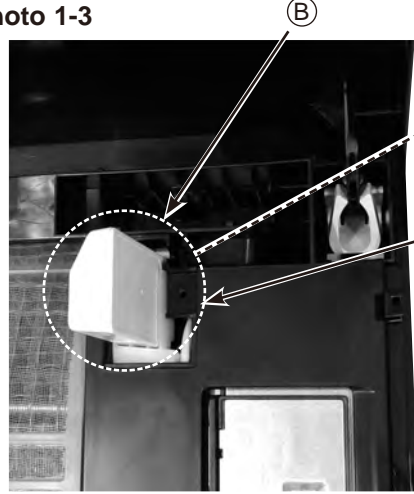
OPERATING PROCEDURE	PHOTOS/FIGURES
<p>1. Removing the panel</p> <p>(1) Remove the front panel. Remove the horizontal vanes.</p> <p>(2) Remove the screw caps of the panel. Remove the screws of the panel.</p> <p>(3) Remove the screw of the Wi-Fi cover on the upper right of the panel, and remove the Wi-Fi cover.</p> <p>(4) Remove the Wi-Fi interface on the right side of the panel. Pull out the Wi-Fi cable, and pull out the cable tie fixed on the panel. (A)</p> <p>(5) Insert Wi-Fi interface into the water cut (B) in the same direction as Photo 1-3, and fix it temporary.</p> <p>(6) Unhook the lower part (C) of the panel.</p> <p>(7) First, hold the lower part of the right end of the panel, and hold the lower part of the left end of the panel.</p> <p>(8) Pull the panel slightly toward you, and then remove the panel by pushing it upward.</p>	<p>Photo 1-1</p>  <p>Photo 1-2</p>  <p>Photo 1-3</p> 

OPERATING PROCEDURE

2. Removing the Wi-Fi interface

- (1) Remove the panel (Refer to section 1.) and the corner box right.
- (2) Remove the screw of the V.A. clamp.
Remove the V.A. clamp and the indoor/outdoor connecting wire.
- (3) Remove the screw of the electrical cover, and remove the electrical cover.
- (4) Disconnect the following connector (Photo 3):
<Indoor electronic control P.C. board>
CN110 (Wi-Fi interface)
- (5) Remove the lead wire of the Wi-Fi interface from the hook of the cable guide and water cut.

3. Removing the indoor electrical box

- (1) Remove the panel (Refer to section 1.) and the corner box right.
- (2) Remove the screw of the V.A. clamp.
Remove the V.A. clamp and the indoor/outdoor connecting wire.
- (3) Remove the earth wire connected to the indoor heat exchanger from the electrical box.
- (4) Remove the screw of the electrical cover and remove the electrical cover.
- (5) Disconnect following connectors:
<Indoor electronic control P.C. board>
CN151 (Vane motor)
CN110 (Wi-Fi interface)
<Indoor power P.C. board>
CN211 (Indoor fan motor)
- (6) Remove the lead wire of the Wi-Fi interface, and remove the Wi-Fi interface (Refer to section 2.).
- (7) Remove the screw fixing the electrical box, then the upper catch of the electrical box, and pull out the electrical box.

4. Removing the indoor power P.C. board, the switch board, the display board, the receiver board and the indoor electronic control P.C. board

- (1) Remove the panel (Refer to Section 1.) and the corner box right.
- (2) Remove the screw of the V.A. clamp. Remove the V.A. clamp and the indoor/outdoor connecting wire.
- (3) Remove the indoor electrical box (Refer to section 3.).
- (4) Remove the earth wire connected to the electrical box from the indoor power P.C. board.
- (5) Disconnect the following connectors:
<Indoor electronic power P.C. board>
CN201 (Terminal block)
CN202 (To the indoor electronic control P.C. board)
- (6) Remove the indoor power P.C. board.
- (7) Disconnect the following connectors:
<Indoor electronic control P.C. board>
CN111 (Room temperature thermistor)
CN112 (Indoor coil thermistor)
- (8) Unhook the catches of the display P.C. board holder from the nozzle and the electrical box (right side).
- (9) Open the rear cover of the display P.C. board holder and remove the switch board, the display board and the receiver board.
Remove the indoor electronic control P.C. board.

PHOTOS/FIGURES

Photo 2

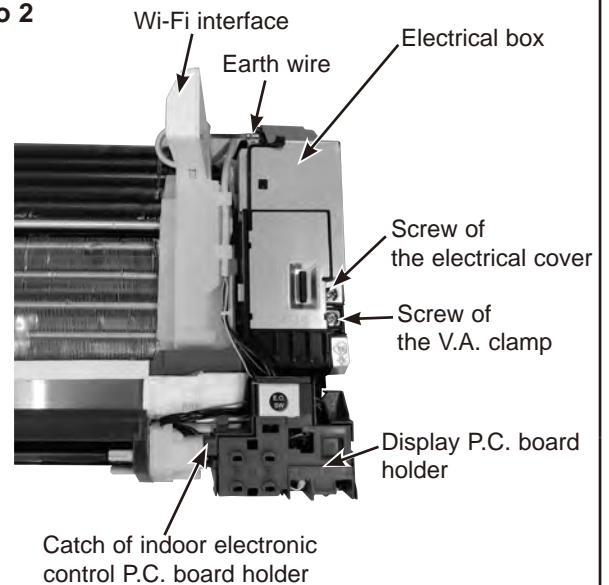
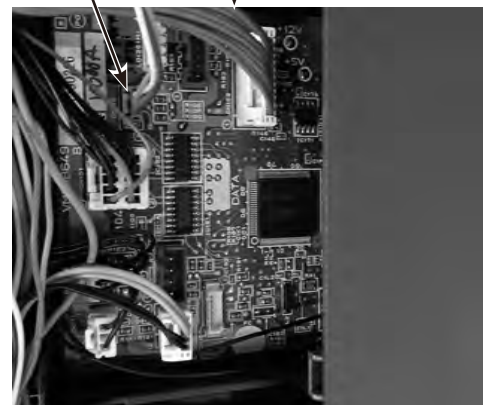
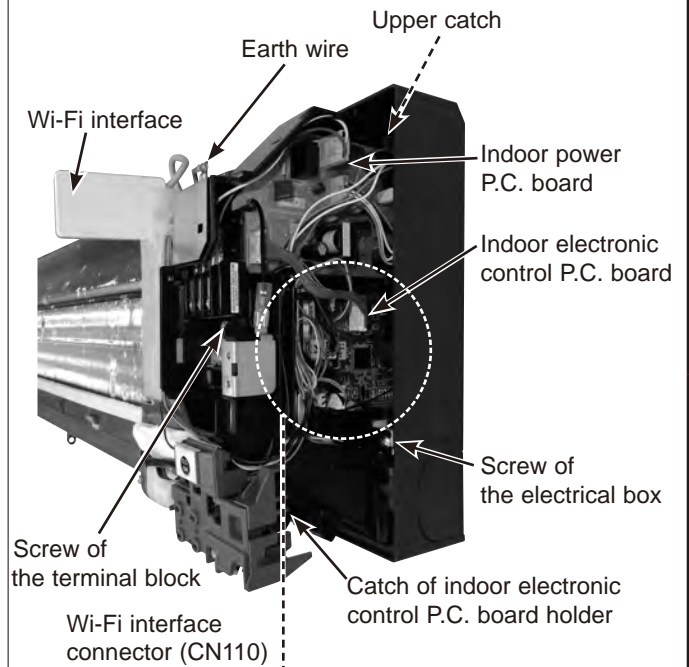

Photo 3



OPERATING PROCEDURE

5. Removing the nozzle assembly

- (1) Remove the panel (Refer to section 1.) and the corner box right.
- (2) Remove the indoor/outdoor connecting wire (Refer to section 3.).
- (3) Remove the electrical cover (Refer to section 3.).
- (4) Disconnect the following connector:
<Indoor electronic control P.C. board>
CN151 (Vane motor)
- (5) Remove the display P.C. board holder.
- (6) Pull out the drain hose from the nozzle assembly and remove the nozzle assembly.
- (7) Remove the vane motors (Refer to section 6.).

6. Removing the horizontal vane motor

- (1) Remove the nozzle assembly (Refer to section 5.).
- (2) Remove the screws of the vane motor unit cover, and pull out the vane motor unit
- (3) Remove the screws of the vane motor unit.
- (4) Disconnect the connector from the vane motor.
- (5) Remove the vane motor from the vane motor unit.

PHOTOS/FIGURES

Photo 4

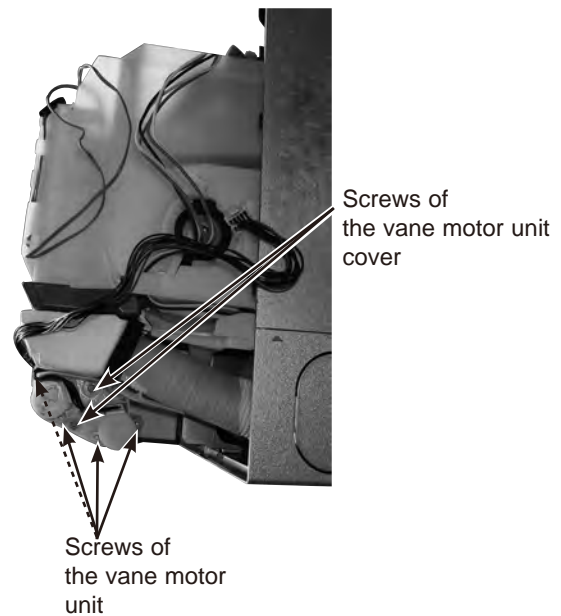

OPERATING PROCEDURE

7. Removing the indoor fan motor, the indoor coil thermistor and the line flow fan

- (1) Remove the panel (Refer to section 1.) and the corner box right.
 - (2) Remove the indoor electronic control P.C. board holder, the electrical box and the nozzle assembly.
 - (3) Remove the screws fixing the motor bed.
 - (4) Release the hooks of the water cut and remove the water cut.
 - (5) Loosen the screw fixing the line flow fan.
 - (6) Remove the motor bed together with the indoor fan motor and the motor band.
 - (7) Release the hooks of the motor band and remove the motor band. Pull out the indoor fan motor.
 - (8) Remove the indoor coil thermistor from the heat exchanger.
- ※ Install the indoor coil thermistor in its former position when assembling it (Photo 5).
- (9) Remove the screws fixing the left side and the upper right side of the heat exchanger (Photo 7, Photo 8).
 - (10) Lift the heat exchanger, and pull out the line flow fan to the lower-left.

- ※ When attaching the line flow fan, screw the line flow fan so 4 mm gap is provided between the right end of the line flow fan and the right wall of the air passage of the box (Figure 1).

Figure 1

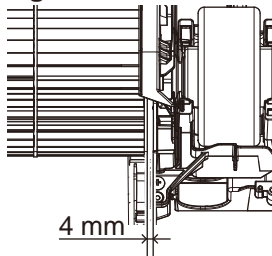
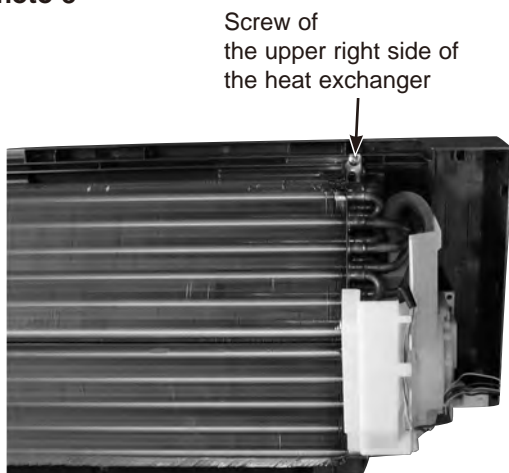

Photo 8



Screw of the upper right side of the heat exchanger

PHOTOS/FIGURES

Photo 5

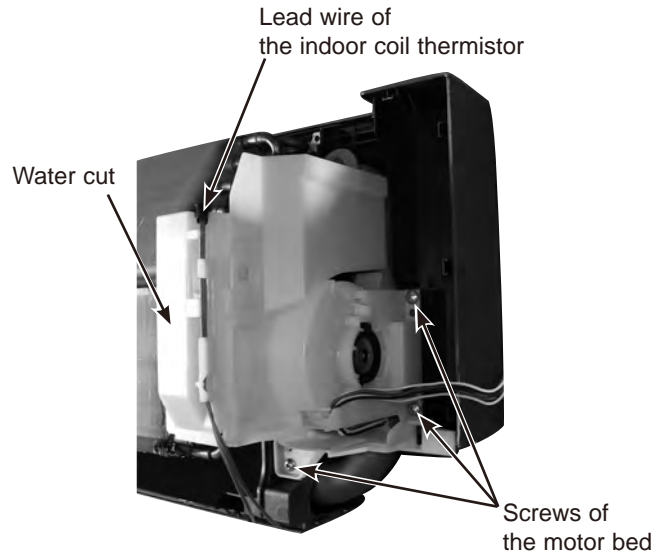

Lead wire of the indoor coil thermistor

Water cut

Screws of the motor bed

Photo 6

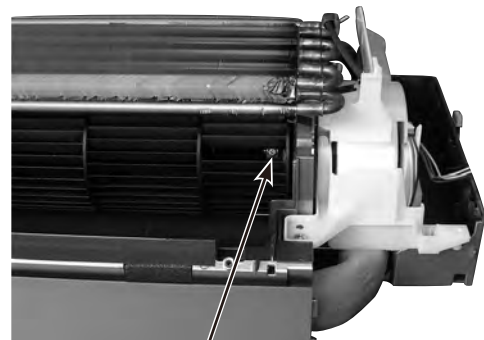

Screw of the line flow fan

Photo 7

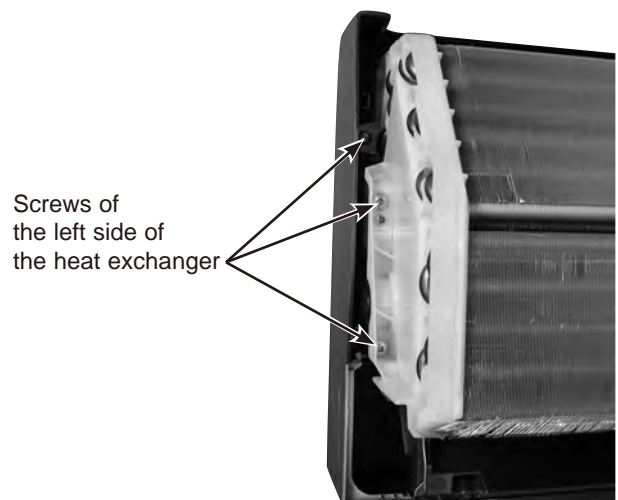

Screws of the left side of the heat exchanger

Fixing the indoor coil thermistor

※ There are 2 forms of parts for fixing the indoor coil thermistor.

Clip shape



Holder shape



When fixing the indoor coil thermistor to the clip-shape/holder-shape part, the lead wire should point down.

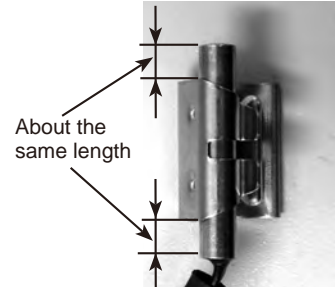

Position and procedure for mounting the clip-shape part

1. Set the indoor coil thermistor in the center of the clip-shape part.



2. Check the (marked) mounting position.



3. Mount the clip-shape part.



NOTE:

- Take care to avoid loss and accidental falling of the clip-shape part inside the unit.
- Mount the clip-shape part on the marked position.
- Do not pull the lead wire when removing the indoor coil thermistor.

MITSUBISHI ELECTRIC CORPORATION

HEAD OFFICE: TOKYO BUILDING, 2-7-3, MARUNOUCHI, CHIYODA-KU, TOKYO 100-8310, JAPAN

© Copyright 2019 MITSUBISHI ELECTRIC CORPORATION
Issued: Jan. 2020. No. OBH831 REVISED EDITION-A
Published: Jan. 2019. No. OBH831
Made in Japan

Specifications are subject to change without notice.