

User reference guide

# Daikin Altherma 3 M

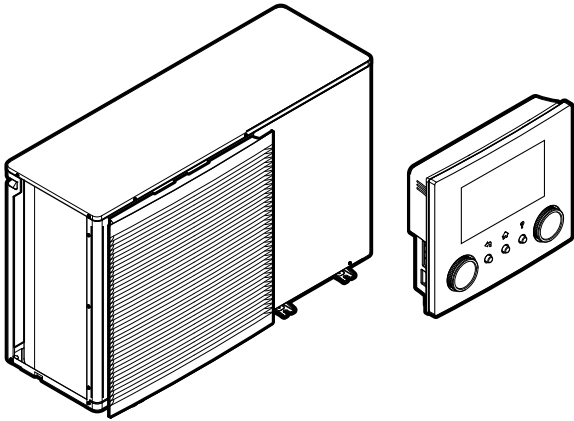

EBLA09~16DAV3  
EBLA09~16DAW1  
EBLA09~16DA3V3  
EBLA09~16DA3W1

EDLA09~16DAV3  
EDLA09~16DAW1  
EDLA09~16DA3V3  
EDLA09~16DA3W1

# Table of contents

<b>1</b>	<b>About this document</b>	<b>4</b>
1.1	Meaning of warnings and symbols	5
<b>2</b>	<b>User safety instructions</b>	<b>7</b>
2.1	General	7
2.2	Instructions for safe operation	8
<b>3</b>	<b>About the system</b>	<b>10</b>
3.1	Components in a typical system layout	10
<b>4</b>	<b>Quick guide</b>	<b>11</b>
4.1	User permission level	11
4.2	Space heating/cooling	11
4.3	Domestic hot water	15
<b>5</b>	<b>Operation</b>	<b>16</b>
5.1	User interface: Overview	16
5.2	Menu structure: Overview user settings	18
5.3	Possible screens: Overview	19
5.3.1	Home screen	19
5.3.2	Main menu screen	22
5.3.3	Setpoint screen	23
5.3.4	Detailed screen with values	24
5.4	Turning operation ON or OFF	24
5.4.1	Visual indication	24
5.4.2	To turn ON or OFF	25
5.5	Reading out information	26
5.6	Space heating/cooling control	26
5.6.1	About space heating/cooling control	26
5.6.2	Setting the space operation mode	26
5.6.3	Determining which temperature control you are using	28
5.6.4	To change the desired room temperature	28
5.6.5	To change the desired leaving water temperature	29
5.7	Domestic hot water control	30
5.7.1	About domestic hot water control	30
5.7.2	Reheat mode	31
5.7.3	Scheduled mode	32
5.7.4	Scheduled + reheat mode	32
5.7.5	To change the domestic hot water temperature	33
5.7.6	Using DHW powerful operation	33
5.8	Preset values and schedules	34
5.8.1	Using preset values	34
5.8.2	Using and programming schedules	35
5.8.3	Schedule screen: Example	38
5.8.4	Setting the energy prices	42
5.9	Weather-dependent curve	44
5.9.1	What is a weather-dependent curve?	44
5.9.2	2-points curve	45
5.9.3	Slope-offset curve	46
5.9.4	Using weather-dependent curves	47
5.10	Other functionalities	49
5.10.1	To configure time and date	49
5.10.2	Using quiet mode	50
5.10.3	Using holiday mode	50
5.10.4	Using WLAN	51
<b>6</b>	<b>Energy saving tips</b>	<b>54</b>
<b>7</b>	<b>Maintenance and service</b>	<b>55</b>
7.1	Overview: Maintenance and service	55
<b>8</b>	<b>Troubleshooting</b>	<b>56</b>
8.1	To display the help text in case of a malfunction	56
8.2	To check the malfunction history	56
8.3	Symptom: You are feeling too cold (hot) in your living room	57
8.4	Symptom: The water at the tap is too cold	57
8.5	Symptom: Heat pump failure	58

8.6	Symptom: The system is making gurgling noises after commissioning.....	58
<b>9</b>	<b>Relocation</b>	<b>60</b>
9.1	Overview: Relocation.....	60
<b>10</b>	<b>Disposal</b>	<b>61</b>
<b>11</b>	<b>Glossary</b>	<b>62</b>
<b>12</b>	<b>Installer settings: Tables to be filled in by installer</b>	<b>63</b>
12.1	Configuration wizard.....	63
12.2	Settings menu .....	64

# 1 About this document

Thank you for purchasing this product. Please:

- Read the documentation carefully before operating the user interface to ensure the best possible performance.
- Request the installer to inform you about the settings that he used to configure your system. Check if he has filled in the installer settings tables. If not, request him to do so.
- Keep the documentation for future reference.

## Target audience

End users

## Documentation set

This document is part of a documentation set. The complete set consists of:

- **General safety precautions:**
  - Safety instructions that you must read before installing
  - Format: Paper (in the box of the outdoor unit)
- **Operation manual:**
  - Quick guide for basic usage
  - Format: Paper (in the box of the outdoor unit)
- **User reference guide:**
  - Detailed step-by-step instructions and background information for basic and advanced usage
  - Format: Digital files on <http://www.daikineurope.com/support-and-manuals/product-information/>
- **Installation manual:**
  - Installation instructions
  - Format: Paper (in the box of the outdoor unit)
- **Installer reference guide:**
  - Preparation of the installation, good practices, reference data, ...
  - Format: Digital files on <http://www.daikineurope.com/support-and-manuals/product-information/>
- **Addendum book for optional equipment:**
  - Additional info about how to install optional equipment
  - Format: Paper (in the box of the outdoor unit) + Digital files on <http://www.daikineurope.com/support-and-manuals/product-information/>

Latest revisions of the supplied documentation may be available on the regional Daikin website or via your installer.

The original documentation is written in English. All other languages are translations.

## Daikin Residential Controller app



If set up by your installer, you can use the Daikin Residential Controller app to control and monitor the status of your system. For more information, see:

<http://www.onlinecontroller.daikineurope.com/>



## Breadcrumbs

Breadcrumbs (example: [4.3]) help you to locate where you are in the menu structure of the user interface.

1	To <b>enable</b> the breadcrumbs: In the home screen or main menu screen, press the help button. The breadcrumbs appear in the top left corner of the screen.	?
2	To <b>disable</b> the breadcrumbs: Press the help button again.	?

This document also mentions these breadcrumbs. **Example:**

1	Go to [4.3]: Space heating/cooling > Operation range.	
---	---	--

This means:

1	Starting from the home screen, turn the left dial and go to Space heating/cooling.	
2	Press the left dial to enter the submenu.	
3	Turn the left dial and go to Operation range.	
4	Press the left dial to enter the submenu.	

## 1.1 Meaning of warnings and symbols



### DANGER

Indicates a situation that results in death or serious injury.



### DANGER: RISK OF ELECTROCUTION

Indicates a situation that could result in electrocution.



**DANGER: RISK OF BURNING/SCALDING**

Indicates a situation that could result in burning/scalding because of extreme hot or cold temperatures.



**DANGER: RISK OF EXPLOSION**

Indicates a situation that could result in explosion.



**WARNING**

Indicates a situation that could result in death or serious injury.



**WARNING: FLAMMABLE MATERIAL**



**CAUTION**

Indicates a situation that could result in minor or moderate injury.



**NOTICE**

Indicates a situation that could result in equipment or property damage.



**INFORMATION**

Indicates useful tips or additional information.

Symbols used on the unit:

Symbol	Explanation
	Before installation, read the installation and operation manual, and the wiring instruction sheet.
	Before performing maintenance and service tasks, read the service manual.
	For more information, see the installer and user reference guide.
	The unit contains rotating parts. Be careful when servicing or inspecting the unit.

Symbols used in the documentation:

Symbol	Explanation
	Indicates a figure title or a reference to it. <b>Example:</b> "▲ 1-3 Figure title" means "Figure 3 in chapter 1".
	Indicates a table title or a reference to it. <b>Example:</b> "■ 1-3 Table title" means "Table 3 in chapter 1".

## 2 User safety instructions

Always observe the following safety instructions and regulations.

### 2.1 General



#### **WARNING**

If you are NOT sure how to operate the unit, contact your installer.



#### **WARNING**

This appliance can be used by children aged from 8 years and above and persons with reduced physical, sensory or mental capabilities or lack of experience and knowledge if they have been given supervision or instruction concerning use of the appliance in a safe way and understand the hazards involved.

Children SHALL NOT play with the appliance.

Cleaning and user maintenance SHALL NOT be made by children without supervision.



#### **WARNING**

To prevent electrical shocks or fire:

- Do NOT rinse the unit.
- Do NOT operate the unit with wet hands.
- Do NOT place any objects containing water on the unit.



#### **CAUTION**

- Do NOT place any objects or equipment on top of the unit.
- Do NOT sit, climb or stand on the unit.

- Units are marked with the following symbol:



This means that electrical and electronic products may NOT be mixed with unsorted household waste. Do NOT try to dismantle the system yourself: the dismantling of the system, treatment of the refrigerant, of oil and of other parts must be done by an authorized installer and must comply with applicable legislation.

Units must be treated at a specialized treatment facility for reuse, recycling and recovery. By ensuring this product is disposed of correctly, you will help to prevent potential negative consequences for the environment and human health. For more information, contact your installer or local authority.

- Batteries are marked with the following symbol:



This means that the batteries may NOT be mixed with unsorted household waste. If a chemical symbol is printed beneath the symbol, this chemical symbol means that the battery contains a heavy metal above a certain concentration.

Possible chemical symbols are: Pb: lead (>0.004%).

Waste batteries must be treated at a specialized treatment facility for reuse. By ensuring waste batteries are disposed of correctly, you will help to prevent potential negative consequences for the environment and human health.

## 2.2 Instructions for safe operation



### **WARNING: MILDLY FLAMMABLE MATERIAL**

The refrigerant inside this unit is mildly flammable.



### **WARNING**

The appliance shall be stored so as to prevent mechanical damage and in a well-ventilated room without continuously operating ignition sources (example: open flames, an operating gas appliance or an operating electric heater).



### **WARNING**

- Do NOT pierce or burn refrigerant cycle parts.
- Do NOT use cleaning materials or means to accelerate the defrosting process other than those recommended by the manufacturer.
- Be aware that the refrigerant inside the system is odourless.





**WARNING**

The refrigerant inside the unit is mildly flammable, but normally does NOT leak. If the refrigerant leaks in the room and comes in contact with fire from a burner, a heater, or a cooker, this may result in fire, or the formation of a harmful gas.

Turn off any combustible heating devices, ventilate the room, and contact the dealer where you purchased the unit.

Do NOT use the unit until a service person confirms that the part from which the refrigerant leaked has been repaired.

**WARNING**

**Air purging heat emitters or collectors.** Before you purge air from heat emitters or collectors, check if  or  is displayed on the home screen of the user interface.

- If not, you can purge air immediately.
- If yes, make sure that the room where you want to purge air is sufficiently ventilated. **Reason:** Refrigerant might leak into the water circuit, and subsequently into the room when you purge air from the heat emitters or collectors.

## 3 About the system

Depending on the system layout, the system can:

- Heat up a space
- Cool down a space
- Produce domestic hot water (if a DHW tank is installed)



### INFORMATION

Cooling is only applicable in case of reversible models.



### INFORMATION

If underfloor heating is installed in the main zone, then in cooling mode the main zone can only provide refreshment. Real cooling is then NOT allowed.

### 3.1 Components in a typical system layout

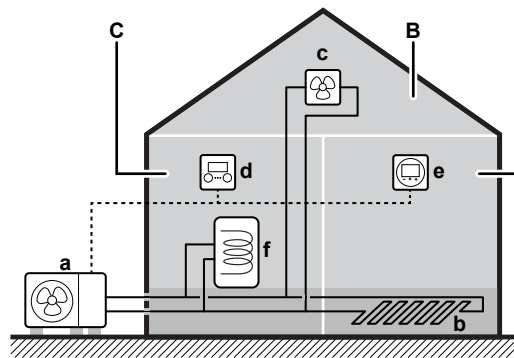

- A** Main zone. **Example:** Living room.
- B** Additional zone. **Example:** Bedroom.
- C** Technical room. **Example:** Garage.
- a** Outdoor unit heat pump
- b** Underfloor heating
- c** Heat pump convectors or fan coil units
- d** User interface
- e** Dedicated Human Comfort Interface (BRC1HHDA used as room thermostat)
- f** Domestic hot water (DHW) tank





## 4 Quick guide

### 4.1 User permission level

The amount of information you can read out and edit in the menu structure depends on your user permission level:

- **User:** Standard mode
- **Advanced user:** You can read out and edit more information

#### To change the user permission level

<b>1</b>	Go to [B]: User profile. 	
<b>2</b>	Enter the applicable pin code for the user permission level.	—
	▪ Browse through the list of digits and change the selected digit.	
	▪ Move the cursor from left to right.	
	▪ Confirm the pin code and proceed.	

#### User pin code

The **User** pin code is **0000**.

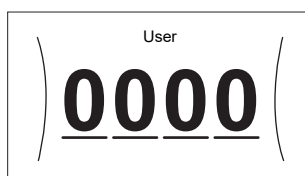

#### Advanced user pin code

The **Advanced user** pin code is **1234**. Additional menu items for the user are now visible.

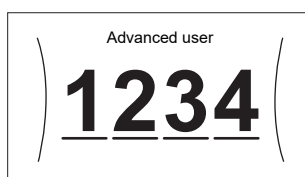

### 4.2 Space heating/cooling

#### To turn space heating/cooling operation ON or OFF



#### NOTICE

**Room frost protection.** Even if you turn OFF space heating/cooling operation ([C.2]: Operation > Space heating/cooling), room frost protection operation –if enabled– can still activate. However, for leaving water temperature control and external room thermostat control, the protection is NOT guaranteed.



**NOTICE**

**Water pipe freeze prevention.** Even if you turn OFF space heating/cooling operation ([C.2]: Operation > Space heating/cooling), water pipe freeze prevention –if enabled– will remain active.

<b>1</b>	Go to [C.2]: Operation > Space heating/cooling.	
<b>2</b>	Set operation to On or Off.	

**To change the desired room temperature**

During room temperature control, you can use the room temperature setpoint screen to read out and adjust the desired room temperature.

<b>1</b>	Go to [1]: Room.	
<b>2</b>	Adjust the desired room temperature.	
	<p><b>a</b> Actual room temperature <b>b</b> Desired room temperature</p>	

**To change the desired leaving water temperature**

You can use the leaving water temperature setpoint screen to read out and adjust the desired leaving water temperature.

<b>1</b>	Go to [2]: Main zone or [3]: Additional zone.	

**2** Adjust the desired leaving water temperature.

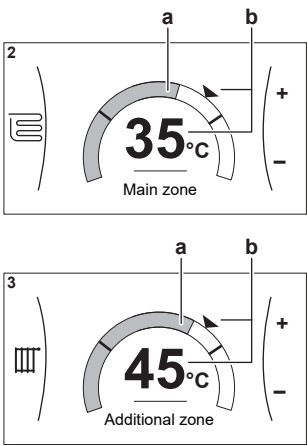

**a** Actual leaving water temperature  
**b** Desired leaving water temperature

### To change the weather-dependent curve for the space heating/cooling zones

**1** Go to the applicable zone:

Zone	Go to ...
Main zone – Heating	[2.5] Main zone > Heating WD curve
Main zone – Cooling	[2.6] Main zone > Cooling WD curve
Additional zone – Heating	[3.5] Additional zone > Heating WD curve
Additional zone – Cooling	[3.6] Additional zone > Cooling WD curve

**2** Change the weather-dependent curve.

There are 2 types of WD curves: **slope-offset curve** (default), and **2-points curve**. If needed, you can change the type in [2.E] Main zone > WD curve type. The way to adjust the curve depends on the type.

#### Slope-offset curve



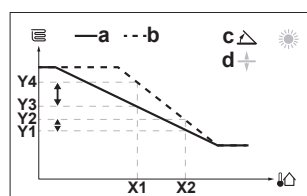

**Slope.** When slope is changed, the new preferred temperature at X1 is unequally higher than the preferred temperature at X2.

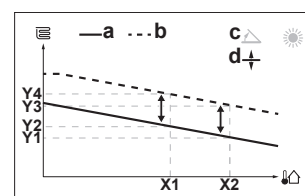

**Offset.** When offset is changed, the new preferred temperature at X1 is equally higher than the preferred temperature at X2.





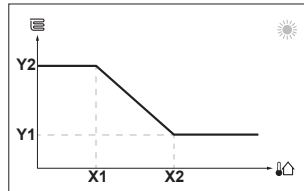

- X1, X2** Outdoor ambient temperature
- Y1~Y4** Desired leaving water temperature
- a** WD curve before changes
- b** WD curve after changes
- c** Slope
- d** Offset

Possible actions on this screen	
	Select slope or offset.
	Increase or decrease the slope/offset.
	When slope is selected: set slope and go to offset. When offset is selected: set offset.
	Confirm changes and return to the submenu.

### 2-points curve



**X1, X2** Outdoor ambient temperature  
**Y1, Y2** Desired leaving water temperature

Possible actions on this screen	
	Go through the temperatures.
	Change the temperature.
	Go to the next temperature.
	Confirm changes and proceed.

### More information

For more information, see also:

- "5.4 Turning operation ON or OFF" [[▶ 24](#)]
- "5.6 Space heating/cooling control" [[▶ 26](#)]
- "5.8 Preset values and schedules" [[▶ 34](#)]
- "5.9 Weather-dependent curve" [[▶ 44](#)]

## 4.3 Domestic hot water

### To turn tank heating operation ON or OFF



#### NOTICE

**Disinfection mode.** Even if you turn OFF tank heating operation ([C.3]: **Operation** > **Tank**), disinfection mode will remain active. However, if you turn it OFF while disinfection is running, an AH error occurs.

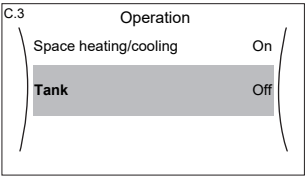
<p><b>1</b></p>	<p>Go to [C.3]: <b>Operation</b> &gt; <b>Tank</b>.</p> 	
<p><b>2</b></p>	<p>Set operation to <b>On</b> or <b>Off</b>.</p>	

### To change the tank temperature setpoint

In **Reheat only** mode, you can use the tank temperature setpoint screen to read out and adjust the domestic hot water temperature.

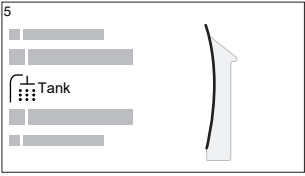
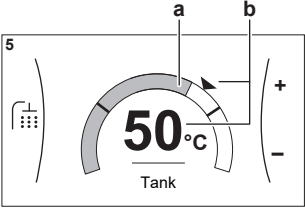
<p><b>1</b></p>	<p>Go to [5]: <b>Tank</b>.</p> 	
<p><b>2</b></p>	<p>Adjust the domestic hot water temperature.</p>  <p><b>a</b> Actual domestic hot water temperature  <b>b</b> Desired domestic hot water temperature</p>	

In other modes, you can only view the setpoint screen but not modify it. Instead, you can modify the settings for the **Comfort setpoint** [5.2], **Eco setpoint** [5.3] and **Reheat setpoint** [5.4].

#### More information

For more information, see also:

- "5.4 Turning operation ON or OFF" [▶ 24]
- "5.7 Domestic hot water control" [▶ 30]
- "5.8 Preset values and schedules" [▶ 34]

# 5 Operation



## INFORMATION

Cooling is only applicable in case of reversible models.

### 5.1 User interface: Overview

The user interface has the following components:

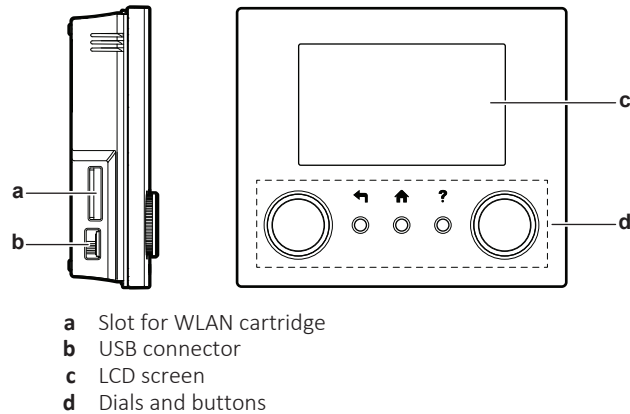

#### Slot for WLAN cartridge

With the WLAN cartridge, the installer can connect the system to the internet. As user you can then control the system via the Daikin Residential Controller app.

**Note:** This slot cannot be used for SD cards.

#### USB connector

With a USB memory stick, the installer can:

- Update the software. This requires a correct config file on the USB memory stick.
- Import the settings generated by E-Configurator (Heating Solutions Navigator) from the USB memory stick to the user interface (MMI). This requires a correct config file on the USB memory stick.
- Export the current settings (i.e. field settings, MMI EEPROM settings, schedule timers) from the user interface (MMI) to the USB memory stick.

#### LCD screen

The LCD screen has a sleeping function. After 15 min of non-interaction with the user interface, the screen darkens. Pressing any button or rotating any dial awakens the display.

#### Dials and buttons

You use the dials and buttons:

- To navigate through the screens, menus and settings of the LCD screen
- To set values



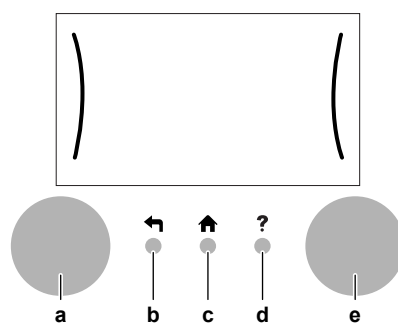

Item		Description
<b>a</b>	Left dial	<p>The LCD shows an arc on the left side of the display when you can use the left dial.</p> <ul style="list-style-type: none"> <li>Turn, then press the left dial. Navigate through the menu structure.</li> <li>Turn the left dial. Choose a menu item.</li> <li>Press the left dial. Confirm your choice or go to a submenu.</li> </ul>
<b>b</b>	Back button	Press to go back 1 step in the menu structure.
<b>c</b>	Home button	Press to go back to the home screen.
<b>d</b>	Help button	Press to show a help text related to the current page (if available).
<b>e</b>	Right dial	<p>The LCD shows an arc on the right side of the display when you can use the right dial.</p> <ul style="list-style-type: none"> <li>Turn, then press the right dial. Change a value or setting, shown at the right side of the screen.</li> <li>Turn the right dial. Navigate through the possible values and settings.</li> <li>Press the right dial. Confirm your choice and go to the next menu item.</li> </ul>

## 5.2 Menu structure: Overview user settings

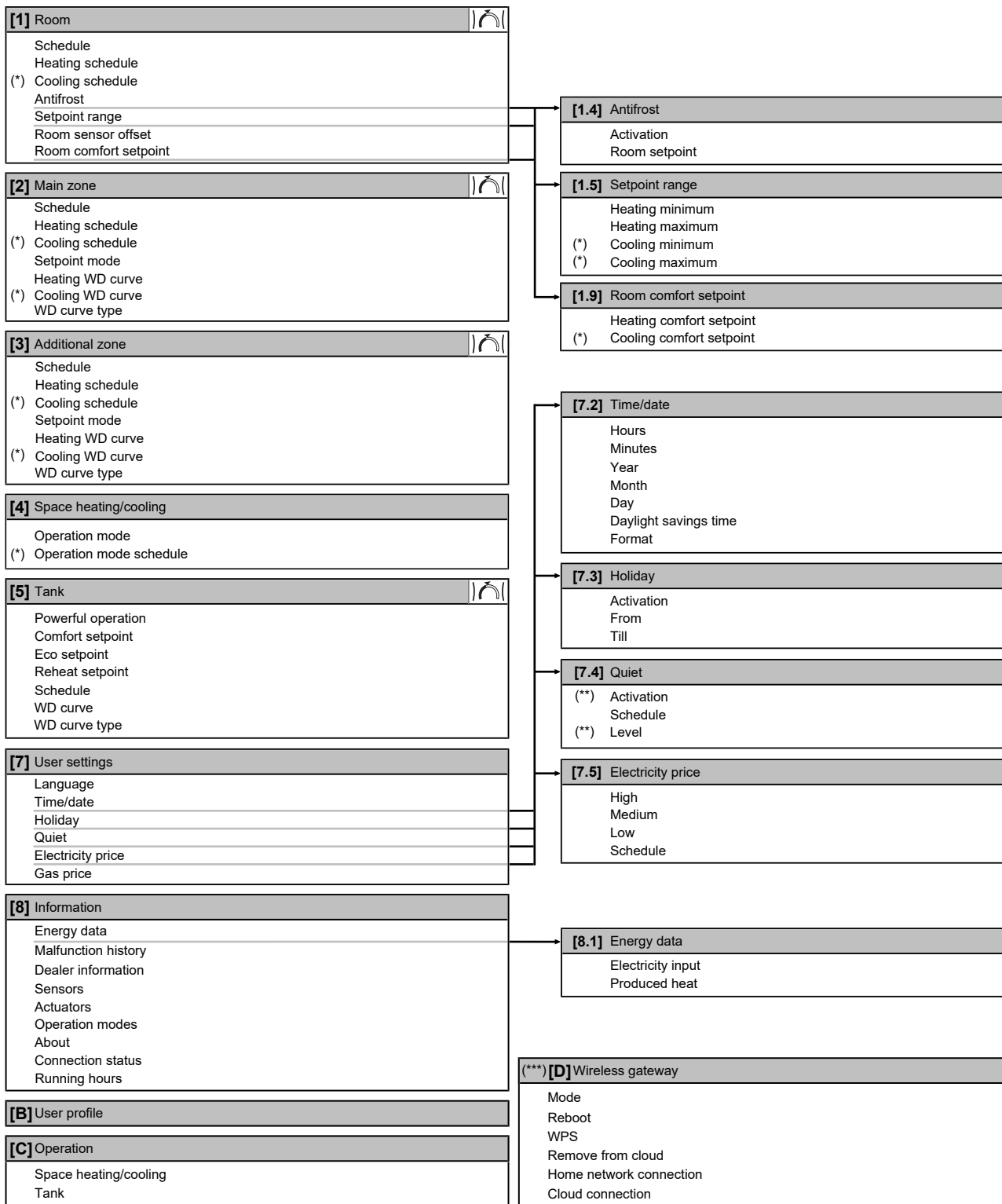

Setpoint screen

(\*) Only applicable for reversible models

(\*\*) Only accessible by installer

(\*\*\*) Only applicable when WLAN is installed



### INFORMATION

Depending on the selected installer settings and unit type, settings will be visible/invisible.

### 5.3 Possible screens: Overview

The most common screens are as follows:

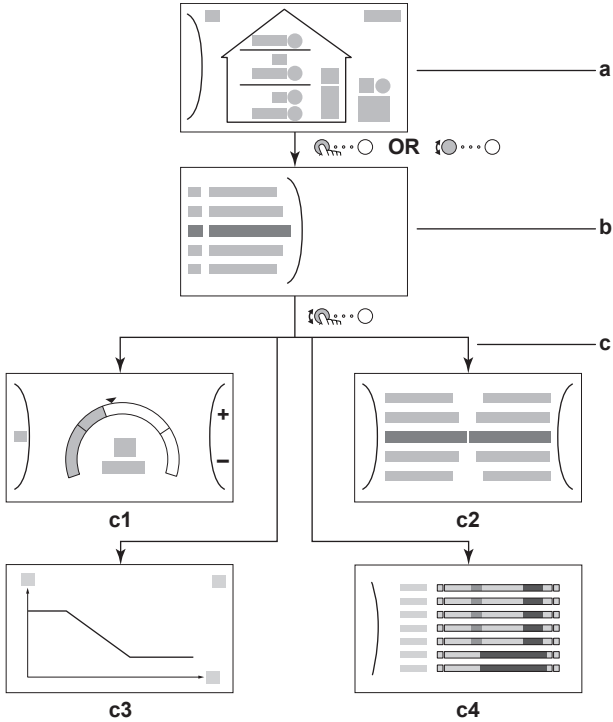







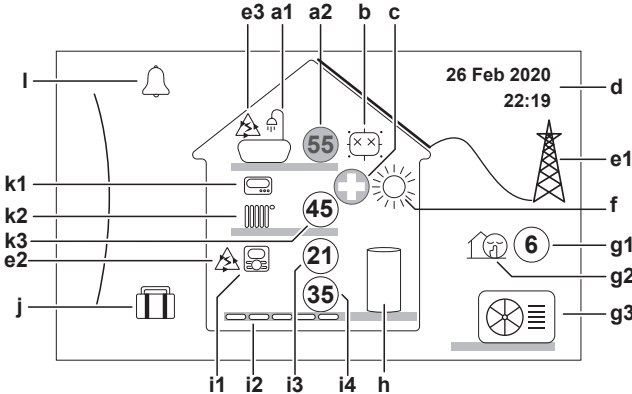







- a** Home screen
- b** Main menu screen
- c** Lower level screens:
  - c1:** Setpoint screen
  - c2:** Detailed screen with values
  - c3:** Screen with weather-dependent curve
  - c4:** Screen with schedule















#### 5.3.1 Home screen

Press the button to go back to the home screen. You see an overview of the unit configuration and the room and setpoint temperatures. Only symbols applicable for your configuration are visible on the home screen.



Possible actions on this screen	
	Go through the list of the main menu.
	Go to the main menu screen.
<b>?</b>	Enable/disable breadcrumbs.

Item		Description
<b>a</b>	<b>Domestic hot water</b>	
	<b>a1</b>	 Domestic hot water
	<b>a2</b>	 Measured tank temperature <sup>(a)</sup>
<b>b</b>	<b>Disinfection / Powerful</b>	
		Disinfection mode active
		Powerful operation mode active
<b>c</b>	<b>Emergency</b>	
		Heat pump failure and system operates in <b>Emergency</b> mode or heat pump is forced off.
<b>d</b>	<b>Current date and time</b>	
<b>e</b>	<b>Smart energy</b>	
	<b>e1</b>	 Smart energy is available via solar panels or smart grid.
	<b>e2</b>	 Smart energy is currently being used for space heating.
	<b>e3</b>	 Smart energy is currently being used for domestic hot water.
<b>f</b>	<b>Space operation mode</b>	
		Cooling
		Heating
<b>g</b>	<b>Outdoor / quiet mode</b>	
	<b>g1</b>	 Measured outdoor temperature <sup>(a)</sup>
	<b>g2</b>	 Quiet mode active
	<b>g3</b>	 Outdoor unit
<b>h</b>	<b>Domestic hot water tank</b>	
		Standalone tank installed

Item	Description		
<b>i</b>	<b>Main zone</b>		
	<b>i1</b>	Installed room thermostat type:	
		Unit operation is decided based on the ambient temperature of the dedicated Human Comfort Interface (BRC1HHDA used as room thermostat).	
		Unit operation is decided by the external room thermostat (wired or wireless).	
	—	No room thermostat installed or set. Unit operation is decided based on the leaving water temperature regardless of the actual room temperature and/or heating demand of the room.	
	<b>i2</b>	Installed heat emitter type:	
		<b>Underfloor heating</b>	
		<b>Fancoil unit</b>	
		<b>Radiator</b>	
	<b>i3</b>		Measured room temperature <sup>(a)</sup>
<b>i4</b>		Leaving water temperature setpoint <sup>(a)</sup>	
<b>j</b>	<b>Holiday mode</b>		
		Holiday mode active	
<b>k</b>	<b>Additional zone</b>		
	<b>k1</b>	Installed room thermostat type:	
		Unit operation is decided by the external room thermostat (wired or wireless).	
	—	No room thermostat installed or set. Unit operation is decided based on the leaving water temperature regardless of the actual room temperature and/or heating demand of the room.	
	<b>k2</b>	Installed heat emitter type:	
		<b>Underfloor heating</b>	
		<b>Fancoil unit</b>	
	<b>Radiator</b>		
<b>k3</b>		Leaving water temperature setpoint <sup>(a)</sup>	
<b>l</b>	<b>Malfunction</b>		
		A malfunction occurred.	
		See "8.1 To display the help text in case of a malfunction" [▶ 56] for more information.	

<sup>(a)</sup> If the corresponding operation (for example: space heating) is not active, the circle is greyed out.

5.3.2 Main menu screen

Starting from the home screen, press (🔍) or turn (🔍) the left dial to open the main menu screen. From the main menu, you can access the different setpoint screens and submenus.

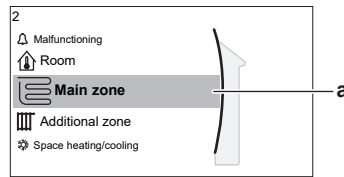

a Selected submenu

Possible actions on this screen	
🔍	Go through the list.
🔍	Enter the submenu.
?	Enable/disable breadcrumbs.

Submenu		Description
[0]	🔔 or ⚠ Malfunctioning	<b>Restriction:</b> Only displayed if a malfunction occurs. See "8.1 To display the help text in case of a malfunction" [▶ 56] for more information.
[1]	🏠 Room	<b>Restriction:</b> Only displayed if a dedicated Human Comfort Interface (BRC1HHDA used as room thermostat) is controlling the outdoor unit. Set the room temperature.
[2]	📄 Main zone	Shows the applicable symbol for your main zone emitter type. Set the leaving water temperature for the main zone.
[3]	📄 Additional zone	<b>Restriction:</b> Only displayed if there are two leaving water temperature zones. Shows the applicable symbol for your additional zone emitter type. Set the leaving water temperature for the additional zone (if present).
[4]	☀ Space heating/cooling	Shows the applicable symbol of your unit. Put the unit in heating mode or cooling mode. You cannot change the mode on heating only models.
[5]	🚿 Tank	Set the domestic hot water tank temperature.
[7]	👤 User settings	Gives access to user settings such as holiday mode and quiet mode.
[8]	📄 Information	Displays data and information about the outdoor unit.
[9]	🔧 Installer settings	<b>Restriction:</b> Only for the installer. Gives access to advanced settings.

Submenu		Description
[A]	Commissioning	<b>Restriction:</b> Only for the installer. Perform tests and maintenance.
[B]	User profile	Change the active user profile.
[C]	Operation	Turn heating/cooling functionality and domestic hot water preparation on or off.
[D]	Wireless gateway	<b>Restriction:</b> Only displayed if a wireless LAN (WLAN) is installed. Contains settings needed when configuring the Daikin Residential Controller app.

### 5.3.3 Setpoint screen

The setpoint screen is displayed for screens describing system components that need a setpoint value.

#### Examples

[1] Room temperature screen

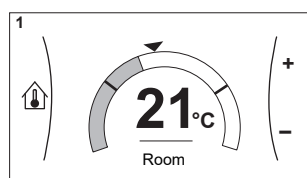

[2] Main zone screen

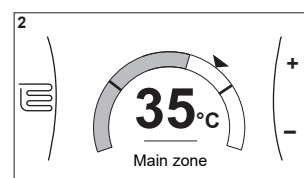

[3] Additional zone screen

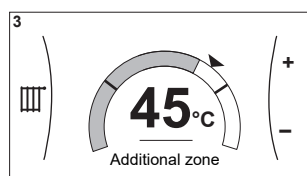

[5] Tank temperature screen

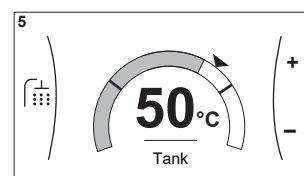

#### Explanation

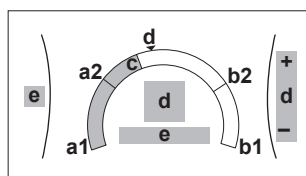

Possible actions on this screen		
	Go through the list of the submenu.	
	Go to the submenu.	
	Adjust and automatically apply the desired temperature.	
Item	Description	
Minimum temperature limit	<b>a1</b>	Fixed by the unit
	<b>a2</b>	Restricted by the installer
Maximum temperature limit	<b>b1</b>	Fixed by the unit
	<b>b2</b>	Restricted by the installer

Item	Description	
Current temperature	<b>c</b>	Measured by the unit
Desired temperature	<b>d</b>	Turn the right dial to increase/decrease.
Submenu	<b>e</b>	Turn or press the left dial to go to the submenu.

### 5.3.4 Detailed screen with values

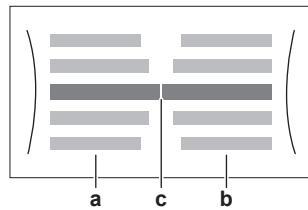

**Example:**

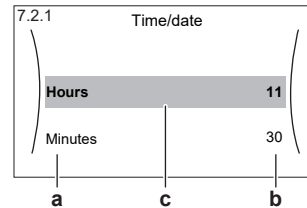

- a** Settings
- b** Values
- c** Selected setting and value

Possible actions on this screen	
	Go through the list of settings.
	Change the value.
	Go to the next setting.
	Confirm changes and proceed.

## 5.4 Turning operation ON or OFF

### 5.4.1 Visual indication

Certain functionalities of the unit can be enabled or disabled separately. If a functionality is disabled, the corresponding temperature icon in the home screen will be greyed out.

#### Space heating/cooling operation

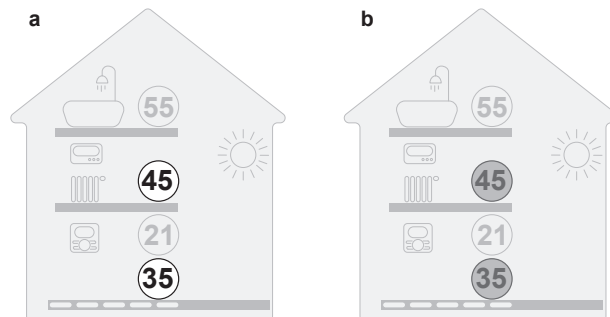

- a** Space heating/cooling operation ON
- b** Space heating/cooling operation OFF



### Tank heating operation

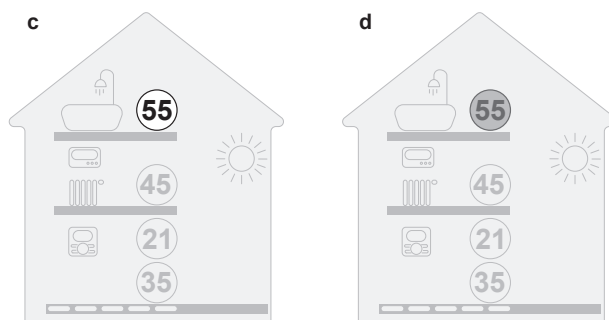

- c** Tank heating operation ON  
**d** Tank heating operation OFF

#### 5.4.2 To turn ON or OFF

### Space heating/cooling operation



#### NOTICE

**Room frost protection.** Even if you turn OFF space heating/cooling operation ([C.2]: Operation > Space heating/cooling), room frost protection operation –if enabled– can still activate. However, for leaving water temperature control and external room thermostat control, the protection is NOT guaranteed.



#### NOTICE

**Water pipe freeze prevention.** Even if you turn OFF space heating/cooling operation ([C.2]: Operation > Space heating/cooling), water pipe freeze prevention –if enabled– will remain active.

<b>1</b>	Go to [C.2]: Operation > Space heating/cooling.	🔍⋯○
<b>2</b>	Set operation to On or Off.	○⋯●

### Tank heating operation



#### NOTICE

**Disinfection mode.** Even if you turn OFF tank heating operation ([C.3]: Operation > Tank), disinfection mode will remain active. However, if you turn it OFF while disinfection is running, an AH error occurs.

<b>1</b>	Go to [C.3]: Operation > Tank.	🔍⋯○
<b>2</b>	Set operation to On or Off.	○⋯●

## 5.5 Reading out information

### To read out information

<b>1</b>	Go to [8]: Information.	
----------	-------------------------	---

### Possible read-out information

In menu...	You can read out...
[8.1] Energy data	Produced energy, consumed electricity, and consumed gas
[8.2] Malfunction history	Malfunction history
[8.3] Dealer information	Contact/helpdesk number
[8.4] Sensors	Room temperature, outside temperature, leaving water temperature,...
[8.5] Actuators	Status/mode of each actuator <b>Example:</b> Unit pump ON/OFF
[8.6] Operation modes	Current operation mode <b>Example:</b> Defrost/oil return mode
[8.7] About	Version information about the system
[8.8] Connection status	Information about the connection status of the unit, the room thermostat and WLAN.
[8.9] Running hours	Running hours of specific system components

## 5.6 Space heating/cooling control

### 5.6.1 About space heating/cooling control

Controlling space heating/cooling typically consists of the following stages:

- 1 Setting the space operation mode
- 2 Controlling the temperature

Depending on the system layout and installer configuration, you use a different temperature control:

- Room thermostat control
- Leaving water temperature control
- External room thermostat control

### 5.6.2 Setting the space operation mode



#### About space operation modes

Your unit can be a heating or a heating/cooling model:

- If your unit is a heating model, it can heat up a space.

- If your unit is a heating/cooling model, it can both heat up and cool down a space. You have to tell the system which operation mode to use.

### To determine if a heating/cooling heat pump model is installed



<b>1</b>	Go to [4]: <b>Space heating/cooling</b> .	
<b>2</b>	Check if [4.1] <b>Operation mode</b> is listed and editable. If so, a heating/cooling heat pump model is installed.	

To tell the system which space operation to use, you can:

You can...	Location
Check which space operation mode is currently used.	Home screen
Set the space operation mode permanently.	Main menu
Restrict automatic changeover according to a monthly schedule.	

### To check which space operation mode is currently used



The space operation mode is displayed on the home screen:

- When the unit is in heating mode, the  icon is shown.
- When the unit is in cooling mode, the  icon is shown.

The status indicator shows if the unit is currently in operation:





- When the unit is not in operation, the status indicator will show a blue pulsation with an interval of approximately 5 seconds.
- While the unit is in operation, the status indicator will light up blue constantly.

### To set the space operation mode

<b>1</b>	Go to [4.1]: <b>Space heating/cooling &gt; Operation mode</b>	
<b>2</b>	Select one of the following options: <ul style="list-style-type: none"> <li>▪ <b>Heating:</b> Only heating mode</li> <li>▪ <b>Cooling:</b> Only cooling mode</li> <li>▪ <b>Automatic:</b> The operation mode changes automatically between heating and cooling based on the outdoor temperature. Restricted per month according to the <b>Operation mode schedule</b> [4.2].</li> </ul>	

### To restrict automatic changeover according to a schedule

**Conditions:** You set the space operation mode to **Automatic**.

<b>1</b>	Go to [4.2]: <b>Space heating/cooling &gt; Operation mode schedule</b> .	
<b>2</b>	Select a month.	
<b>3</b>	For each month, select an option: <ul style="list-style-type: none"> <li>▪ <b>Reversible:</b> Not restricted</li> <li>▪ <b>Heating only:</b> Restricted</li> <li>▪ <b>Cooling only:</b> Restricted</li> </ul>	
<b>4</b>	Confirm the changes.	

**Example: Changeover restrictions**

When	Restriction
During cold season. <b>Example:</b> October, November, December, January, February and March.	Heating only
During warm season. <b>Example:</b> June, July and August.	Cooling only
In-between. <b>Example:</b> April, May and September.	Reversible

5.6.3 Determining which temperature control you are using

**To determine which temperature control you are using (method 1)**

Check the installer settings table filled in by the installer.

**To determine which temperature control you are using (method 2)**

You can see on the home screen which temperature control you are using.

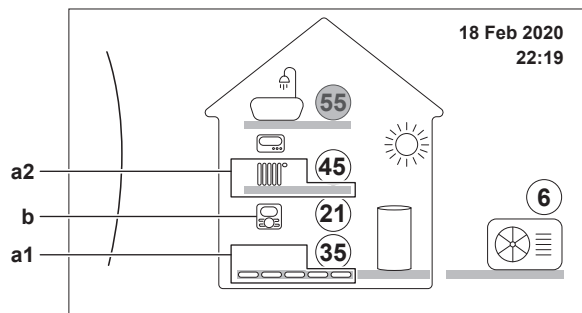

- a1** Heat emitter of the main zone (in this example Underfloor heating)
- a2** Heat emitter of the additional zone (in this example Radiator). If no icon is displayed, there is no additional zone.
- b** Room thermostat type of the main zone:

If b=...	Then the temperature control is...	
	Main zone	Additional zone (if any)
	Room thermostat control	External room thermostat control
	External room thermostat control	
No icon	Leaving water temperature control	Leaving water temperature control

5.6.4 To change the desired room temperature

During room temperature control, you can use the room temperature setpoint screen to read out and adjust the desired room temperature.

<b>1</b>	Go to [1]: Room.	

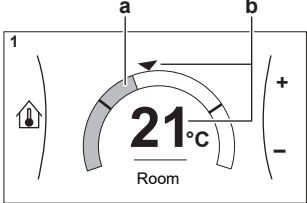
<b>2</b>	Adjust the desired room temperature.	○●●●●●
		
<p><b>a</b> Actual room temperature</p> <p><b>b</b> Desired room temperature</p>		

#### If scheduling is on after changing the desired room temperature

- The temperature will stay the same as long as there is no scheduled action.
- The desired room temperature will return to its scheduled value whenever a scheduled action occurs.

You can avoid scheduled behaviour by (temporarily) turning off scheduling.

#### To turn off room temperature scheduling

<b>1</b>	Go to [1.1]: Room > Schedule.	🏠●●●●●
<b>2</b>	Select No.	🏠●●●●●

### 5.6.5 To change the desired leaving water temperature



#### INFORMATION

The leaving water is the water that is sent to the heat emitters. The desired leaving water temperature is set by your installer in accordance with the heat emitter type. Only adjust the leaving water temperature settings in case of problems.

You can use the leaving water temperature setpoint screen to read out and adjust the desired leaving water temperature.

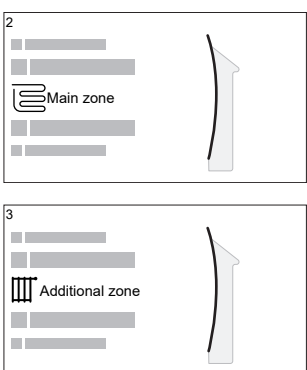
<b>1</b>	Go to [2]: Main zone or [3]: Additional zone.	🏠●●●●●
		

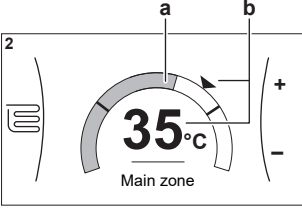
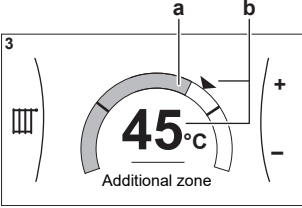
<b>2</b>	Adjust the desired leaving water temperature.	○●●●○
		
		
<p><b>a</b> Actual leaving water temperature</p> <p><b>b</b> Desired leaving water temperature</p>		

**If scheduling is on after changing the desired leaving water temperature**

- The temperature will stay the same as long as there is no scheduled action.
- The desired leaving water temperature will return to its scheduled value whenever a scheduled action occurs.

You can avoid scheduled behaviour by (temporarily) turning off scheduling.

**To turn off leaving water temperature scheduling**

<b>1</b>	Go to one of the following: <ul style="list-style-type: none"> <li>▪ [2.1]: <b>Main zone</b> &gt; <b>Schedule</b></li> <li>▪ [3.1]: <b>Additional zone</b> &gt; <b>Schedule</b></li> </ul>	🔊●●●○
<b>2</b>	Select <b>No</b> .	🔊●●●○

**To enable weather-dependent operation for the leaving water temperature**

See "5.9.4 Using weather-dependent curves" [▶ 47].

## 5.7 Domestic hot water control

### 5.7.1 About domestic hot water control

Depending on the DHW tank mode (installer setting), you use a different domestic hot water control:

- **Reheat only**
- **Schedule + reheat**
- **Schedule only**

 **CAUTION**

The booster heater permission schedule is used to restrict or allow booster heater operation based on a weekly program. Advice: In order to avoid unsuccessful disinfection function, at least allow the booster heater (by the weekly program) for minimum 4 hours starting from the scheduled start-up of disinfection. If the booster heater is restricted during disinfection, this function will NOT be successful and the applicable warning AH will be generated.

**INFORMATION**

In case of error code AH and no interruption of the disinfection function occurred due to domestic hot water tapping, following actions are recommended:

- When the **Reheat only** or **Schedule + reheat** mode is selected, it is recommended to program the start-up of the disinfection function at least 4 hours later than the last expected large hot water tapping. This start-up can be set by installer settings (disinfection function).
- When the **Schedule only** mode is selected, it is recommended to program an **Eco** action 3 hours before the scheduled start-up of the disinfection function to preheat the tank.

When weather-dependent operation is used for the tank, the tank temperature is determined automatically by the outdoor temperature. For more information, see "[5.9 Weather-dependent curve](#)" [▶ 44].

### To determine which domestic hot water mode you are using (method 1)

Check the installer settings table filled in by the installer.

### To determine which domestic hot water mode you are using (method 2)

<b>1</b>	Go to [5]: Tank.	🔍⋯○
<b>2</b>	Check which items are displayed:	🔍●⋯○

[5.1] — Powerful operation

[5.2] — Comfort setpoint

[5.3] — Eco setpoint

[5.4] — Reheat setpoint

[5.5] — Schedule

If... is displayed	Then the DHW tank mode =...
Only [5.1] <b>Powerful operation</b>	Reheat only
All items except [5.4] <b>Reheat setpoint</b> are displayed	Schedule only
All items including [5.4] <b>Reheat setpoint</b> are displayed	Schedule + reheat

## 5.7.2 Reheat mode

In reheat mode the DHW tank continuously heats up to the temperature shown on the home screen (example: 50°C) when the temperature drops below a certain value.

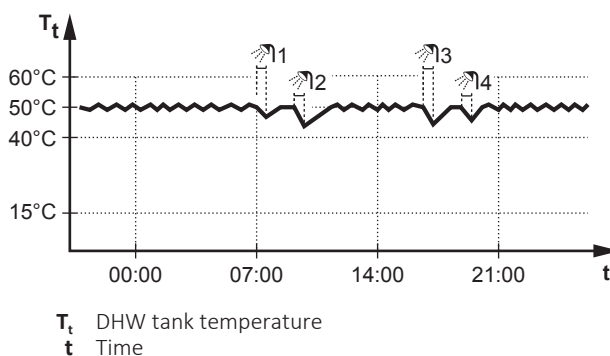

**INFORMATION**

Risk of space heating capacity shortage for domestic hot water tank without internal booster heater: In case of frequent domestic hot water operation, frequent and long space heating/cooling interruption will happen when selecting the following:

**Tank > Heat up mode > Reheat only.**

**INFORMATION**

When the DHW tank mode is reheat, the risk for capacity shortage and comfort problem is significant. In case of frequent reheat operation, space heating/cooling function is regularly interrupted.

### 5.7.3 Scheduled mode

In scheduled mode the DHW tank produces hot water corresponding to a schedule. The best time to allow the tank to produce hot water is at night, because the space heating demand is lower.

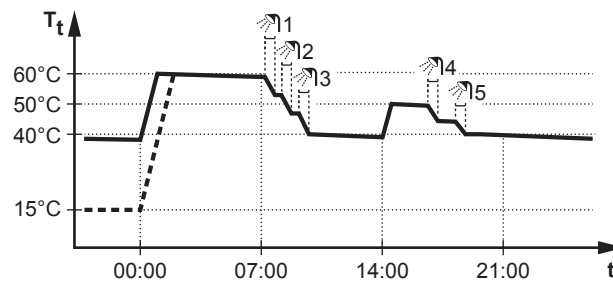
**Example:**

$T_t$  DHW tank temperature  
 $t$  Time

- Initially, the DHW tank temperature is the same as the temperature of the domestic water entering the DHW tank (example: **15°C**).
- At 00:00 the DHW tank is programmed to heat up the water to a preset value (example: **Comfort = 60°C**).
- During the morning, you consume hot water and the DHW tank temperature decreases.
- At 14:00 the DHW tank is programmed to heat up the water to a preset value (example: **Eco = 50°C**). Hot water is available again.
- During the afternoon and evening, you consume hot water again and the DHW tank temperature decreases again.
- At 00:00 the next day, the cycle repeats.

### 5.7.4 Scheduled + reheat mode

In scheduled + reheat mode, the domestic hot water control is the same as in scheduled mode. However, when the DHW tank temperature drops below a preset value (=reheat tank temperature – hysteresis value; example: 35°C), the DHW tank heats up until it reaches the reheat set point (example: 45°C). This ensures that a minimum amount of hot water is available at all times.



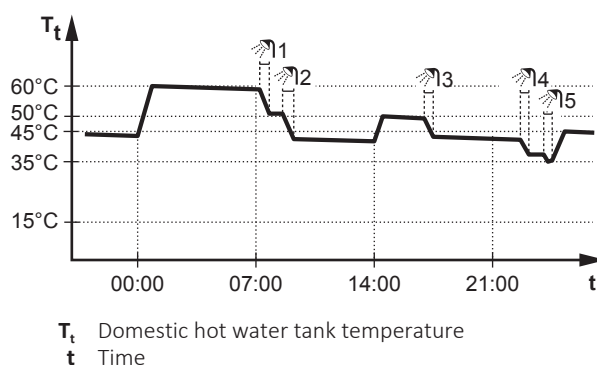

**Example:**



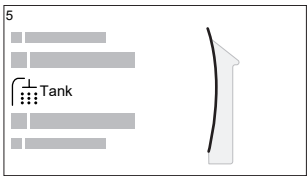

### 5.7.5 To change the domestic hot water temperature

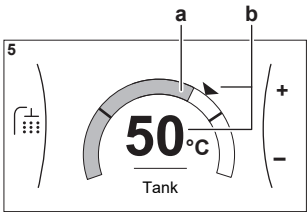
In **Reheat only** mode, you can use the tank temperature setpoint screen to read out and adjust the domestic hot water temperature.

<b>1</b>	Go to [5]: Tank. 	
<b>2</b>	Adjust the domestic hot water temperature.  <b>a</b> Actual domestic hot water temperature <b>b</b> Desired domestic hot water temperature	

In other modes, you can only view the setpoint screen but not modify it. Instead, you can modify the settings for the **Comfort setpoint** [5.2], **Eco setpoint** [5.3] and **Reheat setpoint** [5.4].

When weather-dependent operation is used for the tank, the tank temperature is determined automatically by the outdoor temperature. For more information, see "[5.9 Weather-dependent curve](#)" [▶ 44].

### 5.7.6 Using DHW powerful operation



#### About powerful operation

**Powerful operation** allows the domestic hot water to be heated by the backup heater or booster heater. Use this mode on days when there is more hot water usage than usual.

#### To check if powerful operation is active

If  is displayed on the home screen, powerful operation is active.

Activate or deactivate **Powerful operation** as follows:

<b>1</b>	Go to [5.1]: Tank > Powerful operation	
<b>2</b>	Turn powerful operation <b>Off</b> or <b>On</b> .	

**Usage example: You immediately need more hot water**

You are in the following situation:

- You already consumed most of your domestic hot water.
- You cannot wait for the next scheduled action to heat up the domestic hot water tank.

Then you can activate powerful operation. The domestic hot water tank will start heating up the water to the **Comfort** temperature.

**INFORMATION**

When powerful operation is active, the risk of space heating/cooling and capacity shortage comfort problems is significant. In case of frequent domestic hot water operation, frequent and long space heating/cooling interruptions will happen.

## 5.8 Preset values and schedules

### 5.8.1 Using preset values

#### About preset values

For some settings in the system, you can define preset values. You only need to set these values one time, then reuse the values in other screens such as the scheduling screen. If you later want to change the value, you only have to do it in one place.

#### Possible preset values

You can set the following user-defined preset values:

Preset value		Where used
Tank temperatures under [5] Tank  <b>Restriction:</b> Only applicable if a DHW tank is present.	[5.2] <b>Comfort setpoint</b>	You can use these preset values in [5.5] <b>Schedule</b> (weekly schedule screen for the DHW tank) if the DHW tank mode is one of the following: <ul style="list-style-type: none"> <li>▪ <b>Schedule only</b></li> <li>▪ <b>Schedule + reheat</b></li> </ul>
	[5.3] <b>Eco setpoint</b>	
	[5.4] <b>Reheat setpoint</b>	The software uses this preset value if the DHW tank mode is <b>Schedule + reheat</b> .
Electricity prices under [7.5] <b>User settings &gt; Electricity price</b>  <b>Restriction:</b> Only applicable if <b>Bivalent</b> is enabled by the installer.	[7.5.1] <b>High</b>	You can use these preset values in [7.5.4] <b>Schedule</b> (weekly schedule screen for the energy prices).  See " <a href="#">5.8.4 Setting the energy prices</a> " [▶ 42].
	[7.5.2] <b>Medium</b>	
	[7.5.3] <b>Low</b>	

Additional to the user-defined preset values, the system also contains some system-defined preset values that you can use when programming schedules.

**Example:** In [7.4.2] **User settings > Quiet > Schedule** (weekly schedule for when the unit has to use which quiet mode level), you can use the following system-defined preset values: **Quiet/More quiet/Most quiet**.





## 5.8.2 Using and programming schedules

### About schedules

Depending on your system layout and installer configuration, schedules for multiple controls may be available.

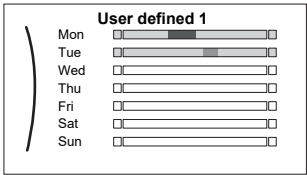
You can...	See...
Set if a specific control needs to act according to a schedule.	" <b>Activation screen</b> " in " <b>Possible schedules</b> " [▶ 35]
Select which schedule you currently want to use for a specific control. The system contains some predefined schedules. You can:	
Consult which schedule is currently selected.	" <b>Schedule/Control</b> " in " <b>Possible schedules</b> " [▶ 35]
Select another schedule if needed.	" <b>To select which schedule you currently want to use</b> " [▶ 35]
Program your own schedules if the predefined schedules are not satisfactory. The actions you can program are control specific.	<ul style="list-style-type: none"> <li>▪ "<b>Possible actions</b>" in "<b>Possible schedules</b>" [▶ 35]</li> <li>▪ "<b>5.8.3 Schedule screen: Example</b>" [▶ 38]</li> </ul>

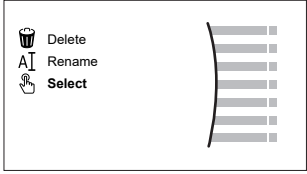
### To select which schedule you currently want to use

<b>1</b>	Go to the schedule for the specific control. See " <b>Schedule/Control</b> " in " <b>Possible schedules</b> " [▶ 35]. <b>Example:</b> For the schedule for the desired room temperature in heating mode, go to [1.2] <b>Room &gt; Heating schedule</b> .	
<b>2</b>	Select the name of the current schedule. 	
<b>3</b>	Select <b>Select</b> . 	
<b>4</b>	Select the schedule that you currently want to use.	

### Possible schedules

The table contains the following information:

- **Schedule/Control:** This column shows you where you can consult the currently selected schedule for the specific control. If needed, you can:
  - Select another schedule. See ["To select which schedule you currently want to use"](#) [▶ 35].
  - Program your own schedule. See ["5.8.3 Schedule screen: Example"](#) [▶ 38].
- **Predefined schedules:** Number of available predefined schedules in the system for the specific control. If needed, you can program your own schedule.
- **Activation screen:** For most controls, a schedule is only effective if it activated in its corresponding activation screen. This entry shows you where to activate it.
- **Possible actions:** Actions you can use when programming a schedule. For most schedules, you can program up to 6 actions per day.

Schedule/Control	Description
<p>[1.2] Room &gt; Heating schedule</p> <p>Schedule for the desired room temperature in heating mode.</p>	<p><b>Predefined schedules:</b> 3</p> <p><b>Activation screen:</b> [1.1] Schedule</p> <p><b>Possible actions:</b> Temperatures within range.</p>
<p>[1.3] Room &gt; Cooling schedule</p> <p>Schedule for the desired room temperature in cooling mode.</p>	<p><b>Predefined schedules:</b> 1</p> <p><b>Activation screen:</b> [1.1] Schedule</p> <p><b>Possible actions:</b> Temperatures within range.</p>
<p>[2.2] Main zone &gt; Heating schedule</p> <p>Schedule for the desired leaving water temperature for the main zone in heating mode.</p>	<p><b>Predefined schedules:</b> 3</p> <p><b>Activation screen:</b> [2.1] Schedule</p> <p><b>Possible actions:</b></p> <ul style="list-style-type: none"> <li>▪ In case of weather-dependent: Shift temperatures within range.</li> <li>▪ Otherwise: Temperatures within range</li> </ul>
<p>[2.3] Main zone &gt; Cooling schedule</p> <p>Schedule for the desired leaving water temperature for the main zone in cooling mode.</p>	<p><b>Predefined schedules:</b> 1</p> <p><b>Activation screen:</b> [2.1] Schedule</p> <p><b>Possible actions:</b></p> <ul style="list-style-type: none"> <li>▪ In case of weather-dependent: Shift temperatures within range.</li> <li>▪ Otherwise: Temperatures within range</li> </ul>
<p>[3.2] Additional zone &gt; Heating schedule</p> <p>Schedule for when the system is allowed to heat up the additional zone in heating mode.</p>	<p><b>Predefined schedules:</b> 1</p> <p><b>Activation screen:</b> [3.1] Schedule</p> <p><b>Possible actions:</b></p> <ul style="list-style-type: none"> <li>▪ <b>Off:</b> When the system is NOT allowed to heat up the additional zone.</li> <li>▪ <b>On:</b> When the system is allowed to heat up the additional zone.</li> </ul>

Schedule/Control	Description
<p>[3.3] Additional zone &gt; Cooling schedule</p> <p>Schedule for when the system is allowed to cool down the additional zone in cooling mode.</p>	<p><b>Predefined schedules:</b> 1</p> <p><b>Activation screen:</b> [3.1] Schedule</p> <p><b>Possible actions:</b></p> <ul style="list-style-type: none"> <li>▪ <b>Off:</b> When the system is NOT allowed to cool down the additional zone.</li> <li>▪ <b>On:</b> When the system is allowed to cool down the additional zone.</li> </ul>
<p>[4.2] Space heating/cooling &gt; Operation mode schedule</p> <p>Schedule (per month) for when to operate the unit in heating mode and when in cooling mode.</p>	<p>See "<a href="#">To set the space operation mode</a>" [▶ 27].</p>
<p>[5.5] Tank &gt; Schedule</p> <p>Schedule for the domestic hot water tank temperature for your normal domestic hot water needs.</p>	<p><b>Predefined schedules:</b> 1</p> <p><b>Activation screen:</b> Not applicable. This schedule is automatically activated if the DHW mode is one of the following:</p> <ul style="list-style-type: none"> <li>▪ Schedule only</li> <li>▪ Schedule + reheat</li> </ul> <p><b>Possible actions:</b></p> <ul style="list-style-type: none"> <li>▪ <b>Comfort:</b> When to start heating the tank to the user-defined preset value [5.2] <b>Comfort setpoint</b>.</li> <li>▪ <b>Eco:</b> When to start heating the tank to the user-defined preset value [5.3] <b>Eco setpoint</b>.</li> <li>▪ <b>Stop:</b> When to stop heating the tank, even if the desired tank temperature is not reached yet.</li> </ul> <p><b>Note:</b> In <b>Schedule + reheat</b> mode, the system also takes the user-defined preset value [5.4] <b>Reheat setpoint</b> into account.</p>
<p>[7.4.2] User settings &gt; Quiet &gt; Schedule</p> <p>Schedule for when the unit has to use which quiet mode level.</p>	<p><b>Predefined schedules:</b> 1</p> <p><b>Activation screen:</b> [7.4.1] <b>Activation</b> (only available to installers).</p> <p><b>Possible actions:</b> You can use the following system-defined preset values:</p> <ul style="list-style-type: none"> <li>▪ Quiet</li> <li>▪ More quiet</li> <li>▪ Most quiet</li> </ul> <p>See "<a href="#">About quiet mode</a>" [▶ 50].</p>

Schedule/Control	Description
<p>[7.5.4] User settings &gt; Electricity price &gt; Schedule</p> <p>Schedule for when a certain electricity tariff is valid.</p>	<p><b>Predefined schedules:</b> 1</p> <p><b>Activation screen:</b> Not applicable</p> <p><b>Possible actions:</b> You can use the following system-defined preset values:</p> <ul style="list-style-type: none"> <li>▪ High</li> <li>▪ Medium</li> <li>▪ Low</li> </ul> <p>See "5.8.4 Setting the energy prices" [▶ 42].</p>
<p><b>Restriction:</b> Only available to installers.</p> <p>[9.4.2] Installer settings &gt; Booster heater &gt; BSH allowance schedule</p>	<p><b>Predefined schedules:</b> 1</p> <p><b>Activation screen:</b> Not applicable</p> <p><b>Possible actions:</b> You can program 2 actions per day.</p> <ul style="list-style-type: none"> <li>▪ Off: Booster heater operation NOT allowed.</li> <li>▪ On: Booster heater operation allowed.</li> </ul>

### 5.8.3 Schedule screen: Example

This example shows how to set a room temperature schedule in heating mode for the main zone.



**INFORMATION**

The procedures to program other schedules are similar.

#### To program the schedule: overview

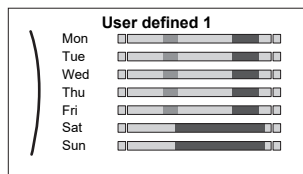

**Example:** You want to program the following schedule:



**Prerequisite:** The room temperature schedule is only available if room thermostat control is active. If leaving water temperature control is active, you can program the main zone schedule instead.

- 1 Go to the schedule.
- 2 (optional) Clear the content of the whole week schedule or the content of a selected day schedule.
- 3 Program the schedule for **Monday**.
- 4 Copy the schedule to the other weekdays.
- 5 Program the schedule for **Saturday** and copy it to **Sunday**.
- 6 Give the schedule a name.

#### To go to the schedule



<b>1</b>	Go to [1.1]: Room > Schedule.	
<b>2</b>	Set scheduling to Yes.	

<b>3</b>	Go to [1.2]: Room > Heating schedule.	
----------	---------------------------------------	--

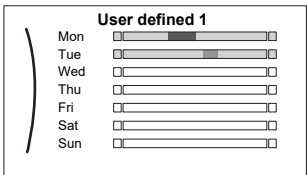
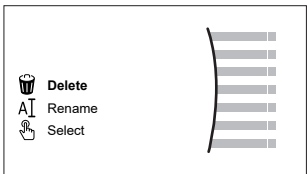

### To clear the content of the week schedule

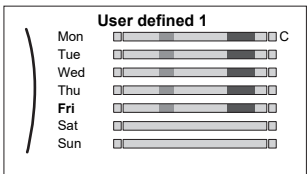

<b>1</b>	Select the name of the current schedule. 	
<b>2</b>	Select Delete. 	
<b>3</b>	Select OK to confirm.	

### To clear the content of a day schedule

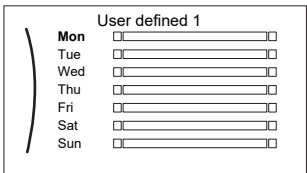



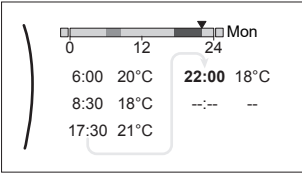

<b>1</b>	Select the day of which you want to clear the content. For example Friday 	
<b>2</b>	Select Delete. 	
<b>3</b>	Select OK to confirm.	

### To program the schedule for Monday

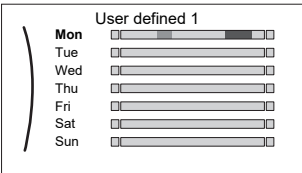

<b>1</b>	Select Monday. 	
<b>2</b>	Select Edit. 	

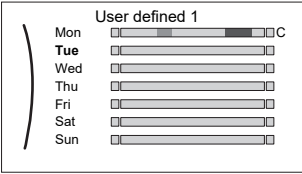
<p><b>3</b></p>	<p>Use the left dial to select an entry and edit the entry with the right dial. You can program up to 6 actions each day. On the bar, a high temperature has a darker colour than a low temperature.</p>  <p><b>Note:</b> To clear an action, set its time as the time of the previous action.</p>	
<p><b>4</b></p>	<p>Confirm the changes.</p> <p><b>Result:</b> The schedule for Monday is defined. The value of the last action is valid until the next programmed action. In this example, Monday is the first day you programmed. Thus, the last programmed action is valid up to the first action of next Monday.</p>	





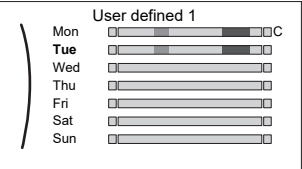

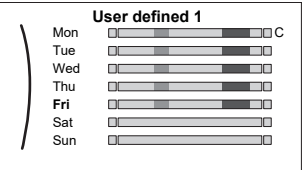

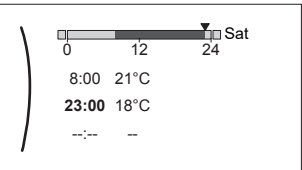

**To copy the schedule to the other weekdays**

<p><b>1</b></p>	<p>Select Monday.</p> 	
<p><b>2</b></p>	<p>Select Copy.</p>  <p><b>Result:</b> Next to the copied day, "C" is displayed.</p>	
<p><b>3</b></p>	<p>Select Tuesday.</p> 	





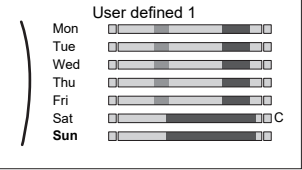



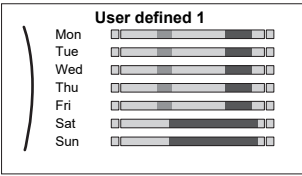

<p><b>4</b></p>	<p>Select <b>Paste</b>.</p>  <p><b>Result:</b></p> 	
<p><b>5</b></p>	<p>Repeat this action for all other weekdays.</p> 	<p>—</p>

**To program the schedule for Saturday and copy it to Sunday**

<p><b>1</b></p>	<p>Select <b>Saturday</b>.</p>	
<p><b>2</b></p>	<p>Select <b>Edit</b>.</p>	
<p><b>3</b></p>	<p>Use the left dial to select an entry and edit the entry with the right dial.</p> 	 
<p><b>4</b></p>	<p>Confirm the changes.</p>	
<p><b>5</b></p>	<p>Select <b>Saturday</b>.</p>	
<p><b>6</b></p>	<p>Select <b>Copy</b>.</p>	
<p><b>7</b></p>	<p>Select <b>Sunday</b>.</p>	
<p><b>8</b></p>	<p>Select <b>Paste</b>.</p> <p><b>Result:</b></p> 	

**To rename the schedule**

<b>1</b>	Select the name of the current schedule.  	
<b>2</b>	Select <b>Rename</b> .  	
<b>3</b>	(optional) To delete the current schedule name, browse through the character list until ← is displayed, then press to remove the previous character. Repeat for each character of the schedule name.	
<b>4</b>	To name the current schedule, browse through the character list and confirm the selected character. The schedule name can contain up to 15 characters.	
<b>5</b>	Confirm the new name.	

	<b>INFORMATION</b> Not all schedules can be renamed.
---	---

**Usage example: You work in a 3-shift system**

If you work in a 3-shift system, you can do the following:

- 1** Program 3 room temperature schedules and give them appropriate names.  
**Example:** EarlyShift, DayShift and LateShift
- 2** Select the schedule that you currently want to use.

5.8.4 Setting the energy prices



In the system, you can set the following energy prices:

- a fixed gas price
- 3 electricity price levels
- a weekly schedule timer for electricity prices.

**Example: How to set the energy prices on the user interface?**

Price	Value in breadcrumb
Fuel: 5.3 euro cents/kWh	[7.6]=5.3
Electricity: 12 euro cents/kWh	[7.5.1]=12

**To set the gas price**

<b>1</b>	Go to [7.6]: <b>User settings &gt; Gas price</b> .	
<b>2</b>	Select the correct gas price.	
<b>3</b>	Confirm the changes.	

**INFORMATION**

Price value ranging from 0.00~990 valuta/kWh (with 2 significant values).

**To set the electricity price**

1	Go to [7.5.1]/[7.5.2]/[7.5.3]: <b>User settings &gt; Electricity price &gt; High/Medium/Low.</b>	
2	Select the correct electricity price.	
3	Confirm the changes.	
4	Repeat this for all three electricity prices.	—

**INFORMATION**

Price value ranging from 0.00~990 valuta/kWh (with 2 significant values).

**INFORMATION**

If no schedule is set, the **Electricity price** for **High** is taken into account.

**To set the electricity price schedule timer**

1	Go to [7.5.4]: <b>User settings &gt; Electricity price &gt; Schedule.</b>	
2	Program the selection using the scheduling screen. You can set the <b>High</b> , <b>Medium</b> and <b>Low</b> electricity prices according to your electricity supplier.	—
3	Confirm the changes.	

**INFORMATION**

The values correspond with the electricity price values for **High**, **Medium** and **Low** previously set. If no schedule is set, the electricity price for **High** is taken into account.

**About energy prices in case of an incentive per kWh renewable energy**

An incentive can be taken into account when setting the energy prices. Although the running cost can increase, the total operation cost, taking into account the reimbursement will be optimized.

**NOTICE**

Make sure to modify the setting of the energy prices at the end of the incentive period.

**To set the gas price in case of an incentive per kWh renewable energy**

Calculate the value for the gas price with the following formula:

- Actual gas price+(Incentive/kWh×0.9)

For the procedure to set the gas price, see "[To set the gas price](#)" [▶ 42].

**To set the electricity price in case of an incentive per kWh renewable energy**

Calculate the value for the electricity price with following formula:

- Actual electricity price+Incentive/kWh

For the procedure to set the electricity price, see ["To set the electricity price"](#) [▶ 43].

### Example

This is an example and the prices and/or values used in this example are NOT accurate.

Data	Price/kWh
Gas price	4.08
Electricity price	12.49
Renewable heat incentive per kWh	5

#### Calculation of the gas price

Gas price=Actual gas price+(Incentive/kWh×0.9)

Gas price=4.08+(5×0.9)

Gas price=8.58

#### Calculation of the electricity price

Electricity price=Actual electricity price+Incentive/kWh

Electricity price=12.49+5

Electricity price=17.49

Price	Value in breadcrumb
Gas: 4.08 /kWh	[7.6]=8.6
Electricity: 12.49 /kWh	[7.5.1]=17

## 5.9 Weather-dependent curve

### 5.9.1 What is a weather-dependent curve?

#### Weather-dependent operation

The unit operates 'weather dependent' if the desired leaving water or tank temperature is determined automatically by the outdoor temperature. It therefore is connected to a temperature sensor on the North wall of the building. If the outdoor temperature drops or rises, the unit compensates instantly. Thus, the unit does not have to wait for feedback by the thermostat to increase or decrease the temperature of the leaving water or tank. Because it reacts more quickly, it prevents high rises and drops of the indoor temperature and water temperature at tap points.

#### Advantage

Weather-dependent operation reduces energy consumption.

#### Weather-dependent curve

To be able to compensate for differences in temperature, the unit relies on its weather-dependent curve. This curve defines how much the temperature of the tank or leaving water must be at different outdoor temperatures. Because the slope of the curve depends on local circumstances such as climate and the insulation of the house, the curve can be adjusted by an installer or user.

### Types of weather-dependent curve

There are 2 types of weather-dependent curves:

- 2-points curve
- Slope-offset curve

Which type of curve you use to make adjustments, depends on your personal preference. See ["5.9.4 Using weather-dependent curves"](#) [▶ 47].

### Availability

The weather-dependent curve is available for:

- Main zone - Heating
- Main zone - Cooling
- Additional zone - Heating
- Additional zone - Cooling
- Tank (only available to installers)



#### INFORMATION

To operate weather dependent, correctly configure the setpoint of the main zone, additional zone or tank. See ["5.9.4 Using weather-dependent curves"](#) [▶ 47].

## 5.9.2 2-points curve

Define the weather-dependent curve with these two setpoints:

- Setpoint (X1, Y2)
- Setpoint (X2, Y1)

### Example

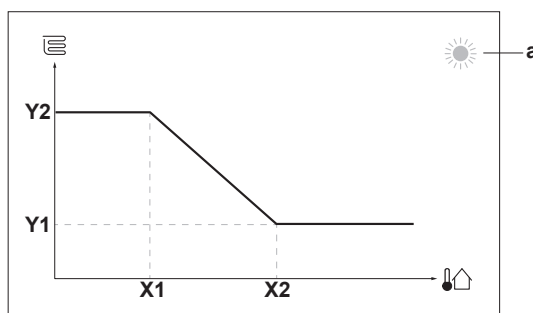



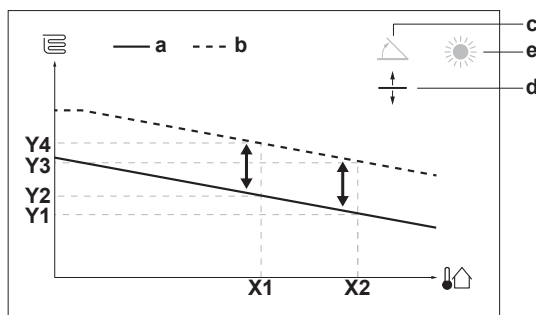

Item	Description
<b>a</b>	WD curve before changes.
<b>b</b>	WD curve after changes (as example): <ul style="list-style-type: none"> <li>▪ When slope is changed, the new preferred temperature at X1 is unequally higher than the preferred temperature at X2.</li> <li>▪ When offset is changed, the new preferred temperature at X1 is equally higher as the preferred temperature at X2.</li> </ul>
<b>c</b>	Slope
<b>d</b>	Offset
<b>e</b>	Selected weather dependent zone: <ul style="list-style-type: none"> <li>▪ ☀: Main zone or additional zone heating</li> <li>▪ ❄: Main zone or additional zone cooling</li> <li>▪ 🏠: Domestic hot water</li> </ul>
<b>X1, X2</b>	Examples of outdoor ambient temperature
<b>Y1, Y2, Y3, Y4</b>	Examples of desired tank temperature or leaving water temperature. The icon corresponds to the heat emitter for that zone: <ul style="list-style-type: none"> <li>▪ 🏠: Underfloor heating</li> <li>▪ 🌀: Fan coil unit</li> <li>▪ 🏠: Radiator</li> <li>▪ 🏠: Domestic hot water tank</li> </ul>

Possible actions on this screen	
☑️⋯⋯○	Select slope or offset.
○⋯⋯⊙	Increase or decrease the slope/offset.
○⋯⋯👉	When slope is selected: set slope and go to offset. When offset is selected: set offset.
👉⋯⋯○	Confirm changes and return to the submenu.

#### 5.9.4 Using weather-dependent curves

Configure weather-dependent curves as following:

##### To define the setpoint mode

To use the weather-dependent curve, you need to define the correct setpoint mode:

Go to setpoint mode ...	Set the setpoint mode to ...
<b>Main zone – Heating</b>	
[2.4] Main zone > Setpoint mode	WD heating, fixed cooling OR Weather dependent
<b>Main zone – Cooling</b>	
[2.4] Main zone > Setpoint mode	Weather dependent
<b>Additional zone – Heating</b>	
[3.4] Additional zone > Setpoint mode	WD heating, fixed cooling OR Weather dependent
<b>Additional zone – Cooling</b>	
[3.4] Additional zone > Setpoint mode	Weather dependent
<b>Tank</b>	
[5.B] Tank > Setpoint mode	<b>Restriction:</b> Only available to installers. Weather dependent

#### To change the type of weather-dependent curve

To change the type for all zones (main + additional) and for the tank, go to [2.E] Main zone > WD curve type.

Viewing which type is selected is also possible via:

- [3.C] Additional zone > WD curve type
- [5.E] Tank > WD curve type

**Restriction:** Only available to installers.

#### To change the weather-dependent curve

Zone	Go to ...
<b>Main zone – Heating</b>	[2.5] Main zone > Heating WD curve
<b>Main zone – Cooling</b>	[2.6] Main zone > Cooling WD curve
<b>Additional zone – Heating</b>	[3.5] Additional zone > Heating WD curve
<b>Additional zone – Cooling</b>	[3.6] Additional zone > Cooling WD curve
<b>Tank</b>	<b>Restriction:</b> Only available to installers. [5.C] Tank > WD curve



#### INFORMATION

##### Maximum and minimum setpoints

You cannot configure the curve with temperatures that are higher or lower than the set maximum and minimum setpoints for that zone or for the tank. When the maximum or minimum setpoint is reached, the curve flattens out.



### To fine-tune the weather-dependent curve: slope-offset curve

The following table describes how to fine-tune the weather-dependent curve of a zone or tank:

You feel ...		Fine-tune with slope and offset:	
At regular outdoor temperatures ...	At cold outdoor temperatures ...	Slope	Offset
OK	Cold	↑	—
OK	Hot	↓	—
Cold	OK	↓	↑
Cold	Cold	—	↑
Cold	Hot	↓	↑
Hot	OK	↑	↓
Hot	Cold	↑	↓
Hot	Hot	—	↓

### To fine-tune the weather-dependent curve: 2-points curve

The following table describes how to fine-tune the weather-dependent curve of a zone or tank:

You feel ...		Fine-tune with setpoints:			
At regular outdoor temperatures ...	At cold outdoor temperatures ...	Y2 <sup>(a)</sup>	Y1 <sup>(a)</sup>	X1 <sup>(a)</sup>	X2 <sup>(a)</sup>
OK	Cold	↑	—	↑	—
OK	Hot	↓	—	↓	—
Cold	OK	—	↑	—	↑
Cold	Cold	↑	↑	↑	↑
Cold	Hot	↓	↑	↓	↑
Hot	OK	—	↓	—	↓
Hot	Cold	↑	↓	↑	↓
Hot	Hot	↓	↓	↓	↓

<sup>(a)</sup> See "5.9.2 2-points curve" [▶ 45].

## 5.10 Other functionalities

### 5.10.1 To configure time and date

<b>1</b>	Go to [7.2] User settings > Time/date.	
----------	--	---

## 5.10.2 Using quiet mode

**About quiet mode**

You can use quiet mode to decrease the sound of the outdoor unit. However, this also decreases the heating/cooling capacity of the system. There are multiple quiet mode levels.

The installer can:

- Completely deactivate quiet mode
- Manually activate a quiet mode level
- Enable the user to program a quiet mode schedule

If enabled by the installer, the user can program a quiet mode schedule.

**INFORMATION**

If the outdoor temperature is below zero, we recommend to NOT use the most quiet level.

**To check if quiet mode is active**

If  is displayed on the home screen, quiet mode is active.

**To program a quiet mode schedule**

**Restriction:** Only possible if enabled by the installer.

<b>1</b>	Go to [7.4.2]: <b>User settings &gt; Quiet &gt; Schedule.</b>	
<b>2</b>	Program the schedule. <b>Possible actions:</b> You can use the following system-defined preset values: <ul style="list-style-type: none"> <li>▪ Quiet</li> <li>▪ More quiet</li> <li>▪ Most quiet</li> </ul> For more information about scheduling, see " <a href="#">5.8.2 Using and programming schedules</a> " [▶ 35].	—

## 5.10.3 Using holiday mode

**About holiday mode**

During your holiday, you can use the holiday mode to deviate from your normal schedules without having to change them. While holiday mode is active, space heating/cooling operation and domestic hot water operation will be turned off. Room frost protection, water pipe freeze prevention and anti-legionella operation will remain active.

**Typical workflow**









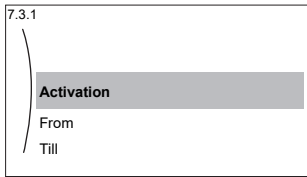

Using holiday mode typically consists of the following stages:

- 1 Setting the starting date and ending date of your holiday.
- 2 Activating the holiday mode.

**To check if holiday mode is activated and/or running**

If  is displayed on the home screen, holiday mode is active.

### To configure the holiday

<b>1</b>	Activate the holiday mode.	—
	<ul style="list-style-type: none"> <li>Go to [7.3.1]: <b>User settings &gt; Holiday &gt; Activation.</b></li> </ul> 	
	<ul style="list-style-type: none"> <li>Select <b>On</b>.</li> </ul>	
<b>2</b>	Set the first day of your holiday.	—
	<ul style="list-style-type: none"> <li>Go to [7.3.2]: <b>From.</b></li> </ul>	
	<ul style="list-style-type: none"> <li>Select a date.</li> </ul>	 
	<ul style="list-style-type: none"> <li>Confirm the changes.</li> </ul>	
<b>3</b>	Set the last day of your holiday.	—
	<ul style="list-style-type: none"> <li>Go to [7.3.3]: <b>Till.</b></li> </ul>	
	<ul style="list-style-type: none"> <li>Select a date.</li> </ul>	 
	<ul style="list-style-type: none"> <li>Confirm the changes.</li> </ul>	

#### 5.10.4 Using WLAN



#### INFORMATION

**Restriction:** WLAN settings are only visible when a WLAN cartridge is inserted in the user interface.

#### About the WLAN cartridge

The WLAN cartridge connects the system to the internet. As user you can then control the system via the Daikin Residential Controller app.

This needs the following components:

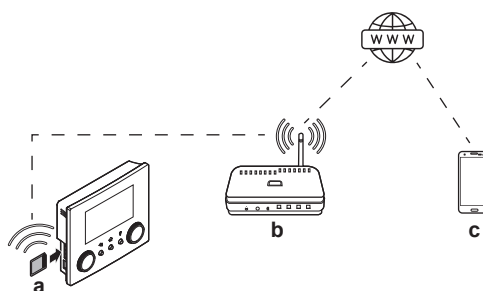

<b>a</b>	WLAN cartridge	The WLAN cartridge needs to be inserted in the user interface.
<b>b</b>	Router	Field supply.

<b>c</b>	Smartphone + app 	The Daikin Residential Controller app needs to be installed on the user's smartphone. See: <a href="http://www.onlinecontroller.daikineurope.com/">http://www.onlinecontroller.daikineurope.com/</a> 
----------	---	--

### Configuration

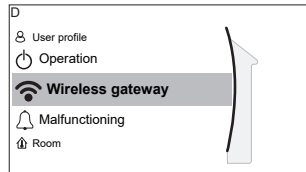

To configure the Daikin Residential Controller app, follow the in-app instructions. While doing this, the following actions and information are needed on the user interface:





#### [D] Wireless gateway

- [D.1] Mode
- [D.2] Reboot
- [D.3] WPS
- [D.4] Remove from cloud
- [D.5] Home network connection
- [D.6] Cloud connection

[D.1] **Mode:** Turn AP mode ON (= WLAN cartridge active as access point):

<b>1</b>	Go to [D.1]: <b>Wireless gateway</b> > <b>Mode</b> .	
<b>2</b>	In the <b>Enable AP mode</b> screen, select <b>Yes</b> .	

[D.2] **Reboot:** Reboot the WLAN cartridge:



<b>1</b>	Go to [D.2]: <b>Wireless gateway</b> > <b>Reboot</b> .	
<b>2</b>	In the <b>Reboot the gateway</b> screen, select <b>OK</b> .	

[D.3] **WPS:** Connect the WLAN cartridge to the router:





#### INFORMATION



You can only use this function if it is supported by the software version of the WLAN, and the software version of the Daikin Residential Controller app.

<b>1</b>	Go to [D.3]: <b>Wireless gateway</b> > <b>WPS</b> .	
<b>2</b>	In the <b>WPS</b> screen, select <b>Yes</b> .	



[D.4] **Remove from cloud:** Remove the WLAN cartridge from the cloud:

<b>1</b>	Go to [D.4]: <b>Wireless gateway</b> > <b>Remove from cloud</b> .	
<b>2</b>	In the <b>Remove from cloud</b> screen, select <b>Yes</b> .	

[D.5] **Home network connection:** Read out the status of the connection to the home network:

<b>1</b>	Go to [D.5]: <b>Wireless gateway</b> > <b>Home network connection</b> .	
<b>2</b>	Read out the connection status: <ul style="list-style-type: none"> <li>▪ <b>Disconnected from [WLAN_SSID]</b></li> <li>▪ <b>Connected to [WLAN_SSID]</b></li> </ul>	

[D.6] **Cloud connection:** Read out the status of the connection to the cloud:

<b>1</b>	Go to [D.6]: <b>Wireless gateway &gt; Cloud connection.</b>	
<b>2</b>	Read out the connection status: <ul style="list-style-type: none"><li>▪ <b>Not connected</b></li><li>▪ <b>Connected</b></li></ul>	

## 6 Energy saving tips

### Tips about room temperature

- Make sure the desired room temperature is NEVER too high (in heating mode) or too low (in cooling mode), but ALWAYS according to your actual needs. Each saved degree can save up to 6% of heating/cooling costs.
- Do NOT increase/decrease the desired room temperature to speed up space heating/cooling. The space will NOT heat up/cool down faster.
- When your system layout contains slow heat emitters (example: underfloor heating), avoid large fluctuation of the desired room temperature and do NOT let the room temperature drop too low/rise too high. It will take more time and energy to heat up/cool down the room again.
- Use a weekly schedule for your normal space heating or cooling needs. If necessary, you can easily deviate from the schedule:
  - For shorter periods: You can overrule the scheduled room temperature until the next scheduled action. **Example:** When you have a party, or when you are leaving for a couple of hours.
  - For longer periods: You can use the holiday mode.

### Tips about leaving water temperature

- In heating mode, a lower desired leaving water temperature results in lower energy consumption and better performance. In cooling, the opposite is valid.
- Set the desired leaving water temperature in accordance with the heat emitter type. **Example:** Underfloor heating is designed for lower leaving water temperature than radiators and heat pump convectors.

### Tips about DHW tank temperature

- Use a weekly schedule for your normal domestic hot water needs (only in scheduled mode).
  - Program to heat up the DHW tank to a preset value (**Comfort** = higher DHW tank temperature) during the night, because then space heating demand is lower.
  - If heating up the DHW tank once at night is not sufficient, program to additionally heat up the DHW tank to a preset value (**Eco** = lower DHW tank temperature) during the day.
- Make sure the desired DHW tank temperature is NOT too high. **Example:** After installation, lower the DHW tank temperature daily by 1°C and check if you still have enough hot water.
- Program to turn ON the domestic hot water pump only during periods of the day when instant hot water is necessary. **Example:** In the morning and evening.

# 7 Maintenance and service

## 7.1 Overview: Maintenance and service

The installer has to perform a yearly maintenance. You can find the contact/helpdesk number via the user interface.

**1** Go to [8.3]: **Information > Dealer information.**



As end user, you have to:

- Keep the area around the unit clean.
- Keep the user interface clean with a soft damp cloth. Do NOT use any detergents.
- Regularly check if the water pressure is above 1 bar.

### Refrigerant

This product contains fluorinated greenhouse gases. Do NOT vent gases into the atmosphere.

Refrigerant type: R32

Global warming potential (GWP) value: 675



#### NOTICE

Applicable legislation on **fluorinated greenhouse gases** requires that the refrigerant charge of the unit is indicated both in weight and CO<sub>2</sub> equivalent.

**Formula to calculate the quantity in CO<sub>2</sub> equivalent tonnes:** GWP value of the refrigerant × total refrigerant charge [in kg] / 1000

Please contact your installer for more information.



#### WARNING: MILDLY FLAMMABLE MATERIAL

The refrigerant inside this unit is mildly flammable.



#### WARNING

The appliance shall be stored so as to prevent mechanical damage and in a well-ventilated room without continuously operating ignition sources (example: open flames, an operating gas appliance or an operating electric heater).



#### WARNING

- Do NOT pierce or burn refrigerant cycle parts.
- Do NOT use cleaning materials or means to accelerate the defrosting process other than those recommended by the manufacturer.
- Be aware that the refrigerant inside the system is odourless.



#### WARNING

The refrigerant inside the unit is mildly flammable, but normally does NOT leak. If the refrigerant leaks in the room and comes in contact with fire from a burner, a heater, or a cooker, this may result in fire, or the formation of a harmful gas.

Turn off any combustible heating devices, ventilate the room, and contact the dealer where you purchased the unit.

Do NOT use the unit until a service person confirms that the part from which the refrigerant leaked has been repaired.

# 8 Troubleshooting



## Contact

For the symptoms listed below, you can try to solve the problem yourself. For any other problem, contact your installer. You can find the contact/helpdesk number via the user interface.

<b>1</b>	Go to [8.3]: <b>Information &gt; Dealer information.</b>	
----------	--	---

## 8.1 To display the help text in case of a malfunction

In case of a malfunction, the following will appear on the home screen depending on the severity:

- : Error
- : Malfunction

You can get a short and a long description of the malfunction as follows:

<b>1</b>	Press the left dial to open the main menu and go to <b>Malfunctioning.</b> <b>Result:</b> A short description of the error and the error code is displayed on the screen.	
<b>2</b>	Press <b>?</b> in the error screen. <b>Result:</b> A long description of the error is displayed on the screen.	<b>?</b>

## 8.2 To check the malfunction history

**Conditions:** The user permission level is set to advanced end user.

<b>1</b>	Go to [8.2]: <b>Information &gt; Malfunction history.</b>	
----------	---	---

You see a list of the most recent malfunctions.



### 8.3 Symptom: You are feeling too cold (hot) in your living room

Possible cause	Corrective action
The desired room temperature is too low (high).	<p>Increase (decrease) the desired room temperature. See <a href="#">"5.6.4 To change the desired room temperature"</a> [▶ 28].</p> <p>If the problem recurs daily, do one of the following:</p> <ul style="list-style-type: none"> <li>▪ Increase (decrease) the room temperature preset value. See <a href="#">"5.8.1 Using preset values"</a> [▶ 34].</li> <li>▪ Adjust the room temperature schedule. See <a href="#">"5.8.2 Using and programming schedules"</a> [▶ 35] and <a href="#">"5.8.3 Schedule screen: Example"</a> [▶ 38].</li> </ul>
The desired room temperature cannot be reached.	Increase the desired leaving water temperature in accordance with the heat emitter type. See <a href="#">"5.6.5 To change the desired leaving water temperature"</a> [▶ 29].
The weather-dependent curve is set incorrectly.	Adjust the weather-dependent curve. See <a href="#">"5.9 Weather-dependent curve"</a> [▶ 44].

### 8.4 Symptom: The water at the tap is too cold

Possible cause	Corrective action
You ran out of domestic hot water because of unusual high consumption.	<p>If you immediately need domestic hot water, activate the DHW tank <b>Powerful operation</b>. However, this consumes extra energy. See <a href="#">"5.7.6 Using DHW powerful operation"</a> [▶ 33].</p> <p>If the problems recurs daily, do one of the following:</p> <ul style="list-style-type: none"> <li>▪ Increase the DHW tank temperature preset value. See <a href="#">"5.8.1 Using preset values"</a> [▶ 34].</li> <li>▪ Adjust the DHW tank temperature schedule. <b>Example:</b> Program to additionally heat up the DHW tank to a preset value (<b>Eco setpoint</b> = lower tank temperature) during the day. See <a href="#">"5.8.2 Using and programming schedules"</a> [▶ 35] and <a href="#">"5.8.3 Schedule screen: Example"</a> [▶ 38].</li> </ul>
The desired DHW tank temperature is too low.	

## 8.5 Symptom: Heat pump failure

When the heat pump fails to operate, the backup heater (if available) and/or booster heater (if available) can serve as an emergency heater. It then takes over the heat load either automatically or by manual interaction.

- When **Emergency** is set to **Automatic** and a heat pump failure occurs, the backup heater automatically takes over the heat load, and the booster heater in the optional tank takes over the domestic hot water production.
- When **Emergency** is set to **Manual** and a heat pump failure occurs, the domestic hot water heating and space heating stops.

To manually recover it via the user interface, go to the **Malfunctioning** main menu screen and confirm whether the backup heater and/or booster heater can take over the heat load or not.

- Alternatively, when **Emergency** is set to:
  - **auto SH reduced/DHW on**, space heating is reduced but domestic hot water is still available.
  - **auto SH reduced/DHW off**, space heating is reduced and domestic hot water is NOT available.
  - **auto SH normal/DHW off**, space heating operates as normally but domestic hot water is NOT available.

Similarly as in **Manual** mode, the unit can take the full load with the backup heater and/or booster heater if the user activates this via the **Malfunctioning** main menu screen.

When the heat pump fails,  or  will appear on the user interface.

Possible cause	Corrective action
Heat pump is damaged.	See "8.1 To display the help text in case of a malfunction" [▶ 56].





### INFORMATION

When the backup heater or booster heater takes over the heat load, electricity consumption will be considerably higher.

## 8.6 Symptom: The system is making gurgling noises after commissioning



Possible cause	Corrective action
There is air in the system.	Purge air from the system. <sup>(a)</sup>
Incorrect hydraulic balance.	To be performed by the installer: <ol style="list-style-type: none"> <li>1 Perform hydraulic balancing to assure that the flow is correctly distributed between the emitters.</li> <li>2 If hydraulic balancing is not sufficient, change the pump limitation settings ([9-0D] and [9-0E] if applicable).</li> </ol>

Possible cause	Corrective action
Various malfunctions.	Check if  or  is displayed on the home screen of the user interface. See <a href="#">"8.1 To display the help text in case of a malfunction" [▶ 56]</a> for more information about the malfunction.

<sup>(a)</sup> We recommend to purge air with the air purge function of the unit (to be performed by the installer). If you purge air from the heat emitters or collectors, mind the following:



#### WARNING

**Air purging heat emitters or collectors.** Before you purge air from heat emitters or collectors, check if  or  is displayed on the home screen of the user interface.

- If not, you can purge air immediately.
- If yes, make sure that the room where you want to purge air is sufficiently ventilated. **Reason:** Refrigerant might leak into the water circuit, and subsequently into the room when you purge air from the heat emitters or collectors.

# 9 Relocation

## 9.1 Overview: Relocation

If you want to relocate parts of your system, contact your installer. You can find the contact/helpdesk number via the user interface.

<b>1</b>	Go to [8.3]: <b>Information &gt; Dealer information.</b>	
----------	--	---

# 10 Disposal

**NOTICE**

Do NOT try to dismantle the system yourself: dismantling of the system, treatment of the refrigerant, oil and other parts **MUST** comply with applicable legislation. Units **MUST** be treated at a specialised treatment facility for reuse, recycling and recovery.

# 11 Glossary

**DHW = Domestic hot water**

Hot water used, in any type of building, for domestic purposes.

**LWT = Leaving water temperature**

Water temperature at the water outlet of the unit.

**Dealer**

Sales distributor for the product.

**Authorised installer**

Technical skilled person who is qualified to install the product.

**User**

Person who is owner of the product and/or operates the product.

**Applicable legislation**

All international, European, national and local directives, laws, regulations and/or codes that are relevant and applicable for a certain product or domain.

**Service company**

Qualified company which can perform or coordinate the required service to the product.

**Installation manual**

Instruction manual specified for a certain product or application, explaining how to install, configure and maintain it.

**Operation manual**

Instruction manual specified for a certain product or application, explaining how to operate it.

**Accessories**

Labels, manuals, information sheets and equipment that are delivered with the product and that need to be installed according to the instructions in the accompanying documentation.

**Optional equipment**

Equipment made or approved by Daikin that can be combined with the product according to the instructions in the accompanying documentation.

**Field supply**

Equipment NOT made by Daikin that can be combined with the product according to the instructions in the accompanying documentation.

# 12 Installer settings: Tables to be filled in by installer

## 12.1 Configuration wizard

Setting		Fill in...
<b>System</b>		
	Backup heater type [9.3.1]	
	Domestic hot water [9.2.1]	
	Emergency [9.5]	
	Number of zones [4.4]	
	Glycol Filled system (overview field setting [E-0D])	
	Booster heater capacity [9.4.1] (if applicable)	
<b>Backup heater</b>		
	Voltage [9.3.2]	
	Configuration [9.3.3]	
	Capacity step 1 [9.3.4]	
	Additional capacity step 2 [9.3.5] (if applicable)	
<b>Main zone</b>		
	Emitter type [2.7]	
	Control [2.9]	
	Setpoint mode [2.4]	
	Schedule [2.1]	
	WD curve type [2.E]	
<b>Additional zone (only if [4.4]=1, dual zone)</b>		
	Emitter type [3.7]	
	Control (read only) [3.9]	
	Setpoint mode [3.4]	
	Schedule [3.1]	
	WD curve type [3.C] (read only)	
<b>Tank (if applicable)</b>		

Setting		Fill in...
	Heat up mode [5.6]	
	Comfort setpoint [5.2]	
	Eco setpoint [5.3]	
	Reheat setpoint [5.4]	
	Setpoint mode [5.B]	
	WD curve type [5.E] (read only)	

## 12.2 Settings menu

Setting		Fill in...
Main zone		
	Thermostat type [2.A]	
Additional zone (if applicable)		
	Thermostat type [3.A]	
Information		
	Dealer information [8.3]	









ERC

Copyright 2020 Daikin

**DAIKIN EUROPE N.V.**  
Zandvoordestraat 300, B-8400 Oostende, Belgium

4P620245-1A 2021.02