

AIR CONDITIONING SYSTEMS

CITY MULTI



DATA BOOK

MODEL

PUHY-P200-1350Y(S)NW-A1(-BS)



Line-up of Outdoor Units of R410A CITY MULTI
Heat Pump Y-Series



PUHY-P200YNW-A1(-BS) PUHY-P250YNW-A1(-BS)
PUHY-P300YNW-A1(-BS)

8, 10, 12HP



PUHY-P350YNW-A1(-BS) PUHY-P400YNW-A1(-BS)
PUHY-P450YNW-A1(-BS)

14, 16, 18HP



PUHY-P500YNW-A1(-BS)

20HP



PUHY-P400YSNW-A1(-BS) PUHY-P450YSNW-A1(-BS)
PUHY-P500YSNW-A1(-BS) PUHY-P550YSNW-A1(-BS)
PUHY-P600YSNW-A1(-BS)

16, 18, 20, 22, 24HP



PUHY-P650YSNW-A1(-BS)

26HP

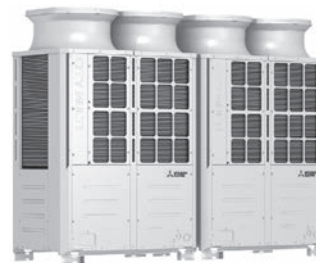

PUHY-P700YSNW-A1(-BS) PUHY-P750YSNW-A1(-BS)
PUHY-P800YSNW-A1(-BS) PUHY-P850YSNW-A1(-BS)
PUHY-P900YSNW-A1(-BS)

28, 30, 32, 34, 36HP



PUHY-P950YSNW-A1(-BS) PUHY-P1000YSNW-A1(-BS)
PUHY-P1050YSNW-A1(-BS)

38, 40, 42HP



PUHY-P1100YSNW-A1(-BS) PUHY-P1150YSNW-A1(-BS)
PUHY-P1200YSNW-A1(-BS) PUHY-P1250YSNW-A1(-BS)
PUHY-P1300YSNW-A1(-BS) PUHY-P1350YSNW-A1(-BS)

44, 46, 48, 50, 52, 54HP

PUHY-P-Y(S)NW-A1

| | |
|---------------------------------------------------------------|-----|
| 1. SPECIFICATIONS | 2 |
| 2. EXTERNAL DIMENSIONS | 29 |
| 3. CENTER OF GRAVITY | 40 |
| 4. ELECTRICAL WIRING DIAGRAMS | 41 |
| 5. SOUND LEVELS | 44 |
| 5-1. Sound levels in cooling mode | 44 |
| 5-2. Sound levels in heating mode..... | 52 |
| 6. VIBRATION LEVEL | 60 |
| 7. OPERATION TEMPERATURE RANGE | 61 |
| 8. CAPACITY TABLES | 62 |
| 8-1. Selection of Cooling/Heating Units | 62 |
| 8-2. Correction by temperature | 68 |
| 8-3. Correction by total indoor..... | 92 |
| 8-4. Correction by refrigerant piping length..... | 106 |
| 8-5. Correction at frost and defrost | 110 |
| 8-6. Correction at evaporation-temperature (ET) control | 110 |
| 9. OPTIONAL PARTS..... | 111 |
| 9-1. JOINT | 111 |
| 9-2. HEADER..... | 112 |
| 9-3. OUTDOOR TWINNING KIT..... | 113 |
| 9-4. FIN GUARD..... | 114 |
| 10.ELECTRICAL WORK | 116 |
| 10-1.General cautions | 116 |
| 10-2.Power supply for Outdoor unit..... | 117 |
| 10-3.Power cable specifications | 118 |
| 10-4.Power supply examples..... | 119 |
| 11.M-NET CONTROL | 122 |
| 11-1.Transmission cable length limitation..... | 122 |
| 11-2.Transmission cable specifications | 123 |
| 11-3.System configuration restrictions..... | 124 |
| 11-4.Address setting..... | 128 |
| 12.PIPING DESIGN | 139 |
| 12-1.R410A Piping material..... | 139 |
| 12-2.Piping Design | 141 |
| 12-3.Refrigerant charging calculation | 145 |
| 13.OUTDOOR INSTALLATION | 147 |
| 13-1.Requirement on installation site | 147 |
| 13-2.Spacing..... | 148 |
| 13-3.Piping direction | 150 |
| 13-4.Countermeasure to wind | 156 |
| 13-5.Precautions for installing a panel heater | 156 |
| 13-6.Caution on selecting outdoor units | 156 |

1. SPECIFICATIONS

Y-Series

PUHY-P-Y(S)NW-A1

| Model | | | PUHY-P200YNW-A1 (-BS) | |
|--------------------------------------------------------|------------------------------|----------------------------------|---------------------------------------------------------------------------------------------------------------------------------------------------------------------------------------------------------------------------------------------------------------|-------------|
| Power source | | | 3-phase 4-wire 380-400-415 V 50/60 Hz | |
| Cooling capacity (Nominal) | *1 | kW | 22.4 | |
| | | BTU/h | 76,400 | |
| | Power input | kW | 4.81 | |
| | Current input | A | 8.1-7.7-7.4 | |
| | EER | kW/kW | 4.65 | |
| | SEER | kW/kW | 7.50 | |
| Temp. range of cooling | Indoor | W.B. | 15.0~24.0°C (59~75°F) | |
| | Outdoor | D.B. | -5.0~52.0°C (23~126°F) | |
| Heating capacity (Max) | *2 | kW | 25.0 | |
| | | BTU/h | 85,300 | |
| | Power input | kW | 5.10 | |
| | Current input | A | 8.6-8.1-7.8 | |
| | COP | kW/kW | 4.90 | |
| | (Nominal) | *3 | kW | 22.4 |
| | | | BTU/h | 76,400 |
| | | Power input | kW | 4.35 |
| | | Current input | A | 7.3-6.9-6.7 |
| | | COP | kW/kW | 5.14 |
| SCOP | kW/kW | 4.39 | | |
| Temp. range of heating | Indoor | D.B. | 15.0~27.0°C (59~81°F) | |
| | Outdoor | W.B. | -20.0~15.5°C (-4~60°F) | |
| Indoor unit connectable | Total capacity | 50~130% of outdoor unit capacity | | |
| | Model/Quantity | P10-P250/1~20 | | |
| Sound pressure level (measured in anechoic room) *4, 5 | | dB <A> | 58.0/59.0 | |
| Sound power level (measured in anechoic room) *4 | | dB <A> | 75/77 | |
| Refrigerant piping diameter | Liquid pipe | mm (in.) | 9.52 (3/8) Brazed | |
| | Gas pipe | mm (in.) | 22.2 (7/8) Brazed | |
| FAN | Type x Quantity | | Propeller fan x 1 | |
| | Air flow rate | m ³ /min | 170 | |
| | | L/s | 2,833 | |
| | | cfm | 6,003 | |
| | Control, Driving mechanism | | Inverter-control, Direct-driven by motor | |
| | Motor output | kW | 0.92 x 1 | |
| *6 | External static press. | 0 Pa (0 mmH ₂ O) | | |
| Compressor | Type | | Inverter scroll hermetic compressor | |
| | Starting method | | Inverter | |
| | Motor output | kW | 3.5 | |
| | Case heater | kW | - | |
| | Lubricant | | MEL32 | |
| External finish | | | Pre-coated galvanized steel sheets (+powder coating for -BS type) <MUNSELL 3Y 7.8/1.1 or similar> | |
| External dimension H x W x D | | mm | 1,858 (1,798 without legs) x 920 x 740 | |
| | | in. | 73-3/16 (70-13/16 without legs) x 36-1/4 x 29-3/16 | |
| Protection devices | High pressure protection | | High pressure sensor, High pressure switch at 4.15 MPa (601 psi) | |
| | Inverter circuit (COMP./FAN) | | Over-current protection | |
| | Compressor | | - | |
| | Fan motor | | - | |
| Refrigerant | Type x original charge | | R410A x 6.5 kg (15 lbs) | |
| | Control | | LEV and HIC circuit | |
| Net weight | | kg (lbs) | 213 (470) | |
| Heat exchanger | | | Salt-resistant cross fin & copper tube | |
| HIC circuit (HIC: Heat Inter-Changer) | | | Copper pipe, tube-in-tube structure | |
| Defrosting method | | | Auto-defrost mode (Reversed refrigerant cycle, Hot gas) | |
| Drawing | External | | KB94C1WV | |
| | Wiring | | KE94L023 | |
| Standard attachment | Document | | Installation Manual | |
| | Accessory | | - | |
| Optional parts | | | Joint: CMY-Y102SS/LS-G2 Header: CMY-Y104/108/1010-G | |
| Remarks | | | Details on foundation work, duct work, insulation work, electrical wiring, power source switch, and other items shall be referred to the Installation Manual. Due to continuing improvement, above specifications may be subject to change without notice. | |

| Notes: | Unit converter |
|--------------------------------------------------------------------------------------------------------------------------------------------------------------------------------------------------------------------------------------------|-------------------------------------------------------------|
| 1. Nominal cooling conditions (subject to JIS B8615-2) Indoor: 27°C D.B./19°C W.B. (81°F D.B./66°F W.B.), Outdoor: 35°C D.B. (95°F D.B.) Pipe length: 7.5 m (24-9/16 ft.), Level difference: 0 m (0 ft.) | BTU/h =kW x 3,412 |
| 2. Nominal heating conditions (subject to JIS B8615-2) Indoor: 20°C D.B. (68°F D.B.), Outdoor: 7°C D.B./6°C W.B. (45°F D.B./43°F W.B.) Pipe length: 7.5 m (24-9/16 ft.), Level difference: 0 m (0 ft.) | cfm =m ³ /min x 35.31 |
| 3. Nominal heating conditions (subject to JIS B8615-2) Indoor: 20°C D.B. (68°F D.B.), Outdoor: 7°C D.B./6°C W.B. (45°F D.B./43°F W.B.) Pipe length: 7.5 m (24-9/16 ft.), Level difference: 0 m (0 ft.) Eurovent registered | lbs =kg/0.4536 |
| 4. Cooling mode/Heating mode | |
| 5. The sound pressure level measured by the conventional method in JIS for reference purpose. | |
| 6. External static pressure option is available (30 Pa, 60 Pa, 80 Pa/3.1 mmH ₂ O, 6.1 mmH ₂ O, 8.2 mmH ₂ O). Consult your dealer about the specification when setting External static pressure option. | *Above specification data is subject to rounding variation. |

1. SPECIFICATIONS

Y-Series

PUHY-P-Y(S)NW-A1

| Model | | PUHY-P250YNW-A1 (-BS) | | |
|--------------------------------------------------------|------------------------------|---------------------------------------------------------------------------------------------------------------------------------------------------------------------------------------------------------------------------------------------------------------|------------------------------------------------------------------|--------------|
| Power source | | 3-phase 4-wire 380-400-415 V 50/60 Hz | | |
| Cooling capacity (Nominal) | *1 | kW | 28.0 | |
| | | BTU/h | 95,500 | |
| | Power input | kW | 7.14 | |
| | Current input | A | 12.0-11.4-11.0 | |
| | EER | kW/kW | 3.92 | |
| | SEER | kW/kW | 7.00 | |
| Temp. range of cooling | Indoor | W.B. | 15.0~24.0°C (59~75°F) | |
| | Outdoor | D.B. | -5.0~52.0°C (23~126°F) | |
| Heating capacity (Max) | *2 | kW | 31.5 | |
| | | BTU/h | 107,500 | |
| | Power input | kW | 7.20 | |
| | Current input | A | 12.1-11.5-11.1 | |
| | COP | kW/kW | 4.37 | |
| | (Nominal) | *3 | kW | 28.0 |
| | | | BTU/h | 95,500 |
| | | Power input | kW | 6.02 |
| | | Current input | A | 10.1-9.6-9.3 |
| | | COP | kW/kW | 4.65 |
| SCOP | kW/kW | 4.21 | | |
| Temp. range of heating | Indoor | D.B. | 15.0~27.0°C (59~81°F) | |
| | Outdoor | W.B. | -20.0~15.5°C (-4~60°F) | |
| Indoor unit connectable | Total capacity | 50~130% of outdoor unit capacity | | |
| | Model/Quantity | P10~P250/1~25 | | |
| Sound pressure level (measured in anechoic room) *4, 5 | | dB <A> | | |
| | | 60.0/61.0 | | |
| Sound power level (measured in anechoic room) *4 | | dB <A> | | |
| | | 78/80 | | |
| Refrigerant piping diameter | Liquid pipe | mm (in.) | 9.52 (3/8) Brazed (12.7 (1/2) Brazed, total length >= 90 m) | |
| | Gas pipe | mm (in.) | 22.2 (7/8) Brazed | |
| FAN | Type x Quantity | | Propeller fan x 1 | |
| | Air flow rate | m ³ /min | 185 | |
| | | L/s | 3,083 | |
| | | cfm | 6,532 | |
| | Control, Driving mechanism | | Inverter-control, Direct-driven by motor | |
| | Motor output | kW | 0.92 x 1 | |
| *6 | External static press. | 0 Pa (0 mmH ₂ O) | | |
| Compressor | Type | | Inverter scroll hermetic compressor | |
| | Starting method | | Inverter | |
| | Motor output | kW | 5.3 | |
| | Case heater | kW | - | |
| | Lubricant | | MEL32 | |
| External finish | | Pre-coated galvanized steel sheets (+powder coating for -BS type) <MUNSELL 3Y 7.8/1.1 or similar> | | |
| External dimension H x W x D | | mm | 1,858 (1,798 without legs) x 920 x 740 | |
| | | in. | 73-3/16 (70-13/16 without legs) x 36-1/4 x 29-3/16 | |
| Protection devices | High pressure protection | | High pressure sensor, High pressure switch at 4.15 MPa (601 psi) | |
| | Inverter circuit (COMP./FAN) | | Over-current protection | |
| | Compressor | | - | |
| | Fan motor | | - | |
| Refrigerant | Type x original charge | | R410A x 6.5 kg (15 lbs) | |
| | Control | | LEV and HIC circuit | |
| Net weight | | kg (lbs) | 213 (470) | |
| Heat exchanger | | Salt-resistant cross fin & copper tube | | |
| HIC circuit (HIC: Heat Inter-Changer) | | Copper pipe, tube-in-tube structure | | |
| Defrosting method | | Auto-defrost mode (Reversed refrigerant cycle, Hot gas) | | |
| Drawing | External | KB94C1WV | | |
| | Wiring | KE94L023 | | |
| Standard attachment | Document | Installation Manual | | |
| | Accessory | - | | |
| Optional parts | | Joint: CMY-Y102SS/LS-G2 Header: CMY-Y104/108/1010-G | | |
| Remarks | | Details on foundation work, duct work, insulation work, electrical wiring, power source switch, and other items shall be referred to the Installation Manual. Due to continuing improvement, above specifications may be subject to change without notice. | | |

Notes:

- Nominal cooling conditions (subject to JIS B8615-2)
Indoor: 27°C D.B./19°C W.B. (81°F D.B./66°F W.B.), Outdoor: 35°C D.B. (95°F D.B.)
Pipe length: 7.5 m (24-9/16 ft.), Level difference: 0 m (0 ft.)
- Nominal heating conditions (subject to JIS B8615-2)
Indoor: 20°C D.B. (68°F D.B.), Outdoor: 7°C D.B./6°C W.B. (45°F D.B./43°F W.B.)
Pipe length: 7.5 m (24-9/16 ft.), Level difference: 0 m (0 ft.)
- Nominal heating conditions (subject to JIS B8615-2)
Indoor: 20°C D.B. (68°F D.B.), Outdoor: 7°C D.B./6°C W.B. (45°F D.B./43°F W.B.)
Pipe length: 7.5 m (24-9/16 ft.), Level difference: 0 m (0 ft.)
Eurovent registered
- Cooling mode/Heating mode
- The sound pressure level measured by the conventional method in JIS for reference purpose.
- External static pressure option is available (30 Pa, 60 Pa, 80 Pa/3.1 mmH₂O, 6.1 mmH₂O, 8.2 mmH₂O).
Consult your dealer about the specification when setting External static pressure option.

Unit converter

| | |
|-------|------------------------------|
| BTU/h | =kW x 3,412 |
| cfm | =m ³ /min x 35.31 |
| lbs | =kg/0.4536 |

*Above specification data is subject to rounding variation.

1. SPECIFICATIONS

Y-Series

PUHY-P-Y(S)NW-A1

| | | | | | | |
|--------------------------------------------------------|------------------------------|----------------------------------|---------------------------------------------------------------------------------------------------------------------------------------------------------------------------------------------------------------------------------------------------------------|----------------|--|--|
| Model | | | PUHY-P300YNW-A1 (-BS) | | | |
| Power source | | | 3-phase 4-wire 380-400-415 V 50/60 Hz | | | |
| Cooling capacity (Nominal) | *1 | kW | 33.5 | | | |
| | | BTU/h | 114,300 | | | |
| | Power input | kW | 8.79 | | | |
| | | A | 14.8-14.0-13.5 | | | |
| | EER | kW/kW | 3.81 | | | |
| | SEER | kW/kW | 6.70 | | | |
| Temp. range of cooling | Indoor | W.B. | 15.0~24.0°C (59~75°F) | | | |
| | Outdoor | D.B. | -5.0~52.0°C (23~126°F) | | | |
| Heating capacity (Max) | *2 | kW | 37.5 | | | |
| | | BTU/h | 128,000 | | | |
| | Power input | kW | 8.46 | | | |
| | | A | 14.2-13.5-13.0 | | | |
| | COP | kW/kW | 4.43 | | | |
| | (Nominal) | *3 | kW | 33.5 | | |
| | | | BTU/h | 114,300 | | |
| | | Power input | kW | 7.11 | | |
| | | | A | 12.0-11.4-10.9 | | |
| | | COP | kW/kW | 4.71 | | |
| SCOP | | kW/kW | 4.16 | | | |
| Temp. range of heating | Indoor | D.B. | 15.0~27.0°C (59~81°F) | | | |
| | Outdoor | W.B. | -20.0~15.5°C (-4~60°F) | | | |
| Indoor unit connectable | Total capacity | 50~130% of outdoor unit capacity | | | | |
| | Model/Quantity | P10~P250/1~30 | | | | |
| Sound pressure level (measured in anechoic room) *4, 5 | | dB <A> | 61.0/64.5 | | | |
| Sound power level (measured in anechoic room) *4 | | dB <A> | 80/84 | | | |
| Refrigerant piping diameter | Liquid pipe | mm (in.) | 9.52 (3/8) Brazed (12.7 (1/2) Brazed, total length >= 40 m) | | | |
| | Gas pipe | mm (in.) | 22.2 (7/8) Brazed | | | |
| FAN | Type x Quantity | | Propeller fan x 1 | | | |
| | Air flow rate | m ³ /min | 240 | | | |
| | | L/s | 4,000 | | | |
| | | cfm | 8,474 | | | |
| | Control, Driving mechanism | | Inverter-control, Direct-driven by motor | | | |
| | *6 | Motor output | kW | 0.92 x 1 | | |
| External static press. | | 0 Pa (0 mmH ₂ O) | | | | |
| Compressor | Type | | Inverter scroll hermetic compressor | | | |
| | Starting method | | Inverter | | | |
| | Motor output | kW | 6.7 | | | |
| | Case heater | kW | - | | | |
| | Lubricant | MEL32 | | | | |
| External finish | | | Pre-coated galvanized steel sheets (+powder coating for -BS type) <MUNSELL 3Y 7.8/1.1 or similar> | | | |
| External dimension H x W x D | | mm | 1,858 (1,798 without legs) x 920 x 740 | | | |
| | | in. | 73-3/16 (70-13/16 without legs) x 36-1/4 x 29-3/16 | | | |
| Protection devices | High pressure protection | | High pressure sensor, High pressure switch at 4.15 MPa (601 psi) | | | |
| | Inverter circuit (COMP./FAN) | | Over-current protection | | | |
| | Compressor | | - | | | |
| | Fan motor | | - | | | |
| Refrigerant | Type x original charge | | R410A x 6.5 kg (15 lbs) | | | |
| | Control | | LEV and HIC circuit | | | |
| Net weight | | kg (lbs) | 226 (499) | | | |
| Heat exchanger | | | Salt-resistant cross fin & copper tube | | | |
| HIC circuit (HIC: Heat Inter-Changer) | | | Copper pipe, tube-in-tube structure | | | |
| Defrosting method | | | Auto-defrost mode (Reversed refrigerant cycle, Hot gas) | | | |
| Drawing | External | | KB94C1WV | | | |
| | Wiring | | KE94L023 | | | |
| Standard attachment | Document | | Installation Manual | | | |
| | Accessory | | - | | | |
| Optional parts | | | Joint: CMY-Y102SS/LS-G2 Header: CMY-Y104/108/1010-G | | | |
| Remarks | | | Details on foundation work, duct work, insulation work, electrical wiring, power source switch, and other items shall be referred to the Installation Manual. Due to continuing improvement, above specifications may be subject to change without notice. | | | |

| | | |
|-------------------------------------------------------------------------------------------------------------------------------------------------------------------------------------------------------------------------------------------|--|-------------------------------------------------------------|
| Notes: | | Unit converter |
| 1.Nominal cooling conditions (subject to JIS B8615-2) Indoor: 27°C D.B./19°C W.B. (81°F D.B./66°F W.B.), Outdoor: 35°C D.B. (95°F D.B.) Pipe length: 7.5 m (24-9/16 ft.), Level difference: 0 m (0 ft.) | | BTU/h =kW x 3,412 |
| 2.Nominal heating conditions (subject to JIS B8615-2) Indoor: 20°C D.B. (68°F D.B.), Outdoor: 7°C D.B./6°C W.B. (45°F D.B./43°F W.B.) Pipe length: 7.5 m (24-9/16 ft.), Level difference: 0 m (0 ft.) | | cfm =m ³ /min x 35.31 |
| 3.Nominal heating conditions (subject to JIS B8615-2) Indoor: 20°C D.B. (68°F D.B.), Outdoor: 7°C D.B./6°C W.B. (45°F D.B./43°F W.B.) Pipe length: 7.5 m (24-9/16 ft.), Level difference: 0 m (0 ft.) Eurovent registered | | lbs =kg/0.4536 |
| 4.Cooling mode/Heating mode | | |
| 5.The sound pressure level measured by the conventional method in JIS for reference purpose. | | |
| 6.External static pressure option is available (30 Pa, 60 Pa, 80 Pa/3.1 mmH ₂ O, 6.1 mmH ₂ O, 8.2 mmH ₂ O). Consult your dealer about the specification when setting External static pressure option. | | *Above specification data is subject to rounding variation. |

1. SPECIFICATIONS

| Model | | PUHY-P350YNW-A1 (-BS) | | | |
|--------------------------------------------------------|------------------------------|---------------------------------------------------------------------------------------------------------------------------------------------------------------------------------------------------------------------------------------------------------------|------------------------------------------------------------------|----------------|----------------|
| Power source | | 3-phase 4-wire 380-400-415 V 50/60 Hz | | | |
| Cooling capacity (Nominal) | *1 | kW | 40.0 | | |
| | | BTU/h | 136,500 | | |
| | | Power input | kW | 10.95 | |
| | | Current input | A | 18.4-17.5-16.9 | |
| | | EER | kW/kW | 3.65 | |
| | | SEER | kW/kW | 6.70 | |
| Temp. range of cooling | Indoor | W.B. | 15.0~24.0°C (59~75°F) | | |
| | Outdoor | D.B. | -5.0~52.0°C (23~126°F) | | |
| Heating capacity (Max) | *2 | kW | 45.0 | | |
| | | BTU/h | 153,500 | | |
| | | Power input | kW | 10.39 | |
| | | Current input | A | 17.5-16.6-16.0 | |
| | | COP | kW/kW | 4.33 | |
| | (Nominal) | *3 | kW | 40.0 | |
| | | | BTU/h | 136,500 | |
| | | | Power input | kW | 8.65 |
| | | | Current input | A | 14.6-13.8-13.3 |
| | | | COP | kW/kW | 4.62 |
| | | | SCOP | kW/kW | 4.24 |
| Temp. range of heating | Indoor | D.B. | 15.0~27.0°C (59~81°F) | | |
| | Outdoor | W.B. | -20.0~15.5°C (-4~60°F) | | |
| Indoor unit connectable | Total capacity | 50~130% of outdoor unit capacity | | | |
| | Model/Quantity | P10~P250/1~35 | | | |
| Sound pressure level (measured in anechoic room) *4, 5 | | dB <A> | 62.0/64.0 | | |
| Sound power level (measured in anechoic room) *4 | | dB <A> | 80/83 | | |
| Refrigerant piping diameter | Liquid pipe | mm (in.) | 12.7 (1/2) Brazed | | |
| | Gas pipe | mm (in.) | 28.58 (1-1/8) Brazed | | |
| FAN | Type x Quantity | | Propeller fan x 2 | | |
| | Air flow rate | m ³ /min | 270 | | |
| | | L/s | 4,500 | | |
| | | cfm | 9,534 | | |
| | Control, Driving mechanism | | Inverter-control, Direct-driven by motor | | |
| | *6 | Motor output | kW | 0.46 x 2 | |
| External static press. | | 0 Pa (0 mmH ₂ O) | | | |
| Compressor | Type | | Inverter scroll hermetic compressor | | |
| | Starting method | | Inverter | | |
| | Motor output | kW | 8.6 | | |
| | Case heater | kW | - | | |
| | Lubricant | | MEL32 | | |
| External finish | | Pre-coated galvanized steel sheets (+powder coating for -BS type) <MUNSELL 3Y 7.8/1.1 or similar> | | | |
| External dimension H x W x D | | mm | 1,858 (1,798 without legs) x 1,240 x 740 | | |
| | | in. | 73-3/16 (70-13/16 without legs) x 48-7/8 x 29-3/16 | | |
| Protection devices | High pressure protection | | High pressure sensor, High pressure switch at 4.15 MPa (601 psi) | | |
| | Inverter circuit (COMP./FAN) | | Over-current protection | | |
| | Compressor | | - | | |
| | Fan motor | | - | | |
| Refrigerant | Type x original charge | | R410A x 9.8 kg (22 lbs) | | |
| | Control | | LEV and HIC circuit | | |
| Net weight | | kg (lbs) | 277 (611) | | |
| Heat exchanger | | Salt-resistant cross fin & copper tube | | | |
| HIC circuit (HIC: Heat Inter-Changer) | | Copper pipe, tube-in-tube structure | | | |
| Defrosting method | | Auto-defrost mode (Reversed refrigerant cycle, Hot gas) | | | |
| Drawing | External | | KB94C1WW | | |
| | Wiring | | KE94L024 | | |
| Standard attachment | Document | | Installation Manual | | |
| | Accessory | | - | | |
| Optional parts | | Joint: CMY-Y102SS/LS-G2, CMY-Y202S-G2 Header: CMY-Y104/108/1010-G | | | |
| Remarks | | Details on foundation work, duct work, insulation work, electrical wiring, power source switch, and other items shall be referred to the Installation Manual. Due to continuing improvement, above specifications may be subject to change without notice. | | | |

Notes:

- Nominal cooling conditions (subject to JIS B8615-2)
Indoor: 27°C D.B./19°C W.B. (81°F D.B./66°F W.B.), Outdoor: 35°C D.B. (95°F D.B.)
Pipe length: 7.5 m (24-9/16 ft.), Level difference: 0 m (0 ft.)
- Nominal heating conditions (subject to JIS B8615-2)
Indoor: 20°C D.B. (68°F D.B.), Outdoor: 7°C D.B./6°C W.B. (45°F D.B./43°F W.B.)
Pipe length: 7.5 m (24-9/16 ft.), Level difference: 0 m (0 ft.)
- Nominal heating conditions (subject to JIS B8615-2)
Indoor: 20°C D.B. (68°F D.B.), Outdoor: 7°C D.B./6°C W.B. (45°F D.B./43°F W.B.)
Pipe length: 7.5 m (24-9/16 ft.), Level difference: 0 m (0 ft.)
Eurovent registered
- Cooling mode/Heating mode
- The sound pressure level measured by the conventional method in JIS for reference purpose.
- External static pressure option is available (30 Pa, 60 Pa, 80 Pa/3.1 mmH₂O, 6.1 mmH₂O, 8.2 mmH₂O).
Consult your dealer about the specification when setting External static pressure option.

Unit converter

| | |
|-------|------------------------------|
| BTU/h | =kW x 3,412 |
| cfm | =m ³ /min x 35.31 |
| lbs | =kg/0.4536 |

*Above specification data is subject to rounding variation.

1. SPECIFICATIONS

Y-Series

PUHY-P-Y(S)NW-A1

| | | | | | | |
|--------------------------------------------------------|------------------------------|----------------------------------|---------------------------------------------------------------------------------------------------------------------------------------------------------------------------------------------------------------------------------------------------------------|----------------|----------------|--|
| Model | | | PUHY-P400YNW-A1 (-BS) | | | |
| Power source | | | 3-phase 4-wire 380-400-415 V 50/60 Hz | | | |
| Cooling capacity (Nominal) | *1 | kW | 45.0 | | | |
| | | BTU/h | 153,500 | | | |
| | Power input | kW | 14.19 | | | |
| | | Current input | A | 23.9-22.7-21.9 | | |
| | | EER | kW/kW | 3.17 | | |
| | | SEER | kW/kW | 6.39 | | |
| Temp. range of cooling | Indoor | W.B. | 15.0~24.0°C (59~75°F) | | | |
| | Outdoor | D.B. | -5.0~52.0°C (23~126°F) | | | |
| Heating capacity (Max) | *2 | kW | 50.0 | | | |
| | | BTU/h | 170,600 | | | |
| | Power input | kW | 12.37 | | | |
| | | Current input | A | 20.8-19.8-19.1 | | |
| | | COP | kW/kW | 4.04 | | |
| | | (Nominal) | *3 | kW | 45.0 | |
| | BTU/h | | | 153,500 | | |
| | Power input | | kW | 10.46 | | |
| | | | Current input | A | 17.6-16.7-16.1 | |
| | | COP | kW/kW | 4.30 | | |
| SCOP | | kW/kW | 4.13 | | | |
| Temp. range of heating | Indoor | D.B. | 15.0~27.0°C (59~81°F) | | | |
| | Outdoor | W.B. | -20.0~15.5°C (-4~60°F) | | | |
| Indoor unit connectable | Total capacity | 50~130% of outdoor unit capacity | | | | |
| | Model/Quantity | P10~P250/1~40 | | | | |
| Sound pressure level (measured in anechoic room) *4, 5 | | dB <A> | 65.0/67.0 | | | |
| Sound power level (measured in anechoic room) *4 | | dB <A> | 82/86 | | | |
| Refrigerant piping diameter | Liquid pipe | mm (in.) | 12.7 (1/2) Brazed | | | |
| | Gas pipe | mm (in.) | 28.58 (1-1/8) Brazed | | | |
| FAN | Type x Quantity | | Propeller fan x 2 | | | |
| | Air flow rate | m ³ /min | 300 | | | |
| | | L/s | 5,000 | | | |
| | | cfm | 10,593 | | | |
| | Control, Driving mechanism | | Inverter-control, Direct-driven by motor | | | |
| | *6 | Motor output | kW | 0.46 x 2 | | |
| External static press. | | 0 Pa (0 mmH ₂ O) | | | | |
| Compressor | Type | | Inverter scroll hermetic compressor | | | |
| | Starting method | | Inverter | | | |
| | Motor output | kW | 11.4 | | | |
| | Case heater | kW | - | | | |
| | Lubricant | | MEL32 | | | |
| External finish | | | Pre-coated galvanized steel sheets (+powder coating for -BS type) <MUNSELL 3Y 7.8/1.1 or similar> | | | |
| External dimension H x W x D | | mm | 1,858 (1,798 without legs) x 1,240 x 740 | | | |
| | | in. | 73-3/16 (70-13/16 without legs) x 48-7/8 x 29-3/16 | | | |
| Protection devices | High pressure protection | | High pressure sensor, High pressure switch at 4.15 MPa (601 psi) | | | |
| | Inverter circuit (COMP./FAN) | | Over-current protection | | | |
| | Compressor | | - | | | |
| | Fan motor | | - | | | |
| Refrigerant | Type x original charge | | R410A x 9.8 kg (22 lbs) | | | |
| | Control | | LEV and HIC circuit | | | |
| Net weight | | kg (lbs) | 277 (611) | | | |
| Heat exchanger | | | Salt-resistant cross fin & copper tube | | | |
| HIC circuit (HIC: Heat Inter-Changer) | | | Copper pipe, tube-in-tube structure | | | |
| Defrosting method | | | Auto-defrost mode (Reversed refrigerant cycle, Hot gas) | | | |
| Drawing | External | | KB94C1WWW | | | |
| | Wiring | | KE94L024 | | | |
| Standard attachment | Document | | Installation Manual | | | |
| | Accessory | | - | | | |
| Optional parts | | | Joint: CMY-Y102SS/LS-G2, CMY-Y202S-G2 Header: CMY-Y104/108/1010-G | | | |
| Remarks | | | Details on foundation work, duct work, insulation work, electrical wiring, power source switch, and other items shall be referred to the Installation Manual. Due to continuing improvement, above specifications may be subject to change without notice. | | | |

| | | |
|-------------------------------------------------------------------------------------------------------------------------------------------------------------------------------------------------------------------------------------------|--|-------------------------------------------------------------|
| Notes: | | Unit converter |
| 1.Nominal cooling conditions (subject to JIS B8615-2) Indoor: 27°C D.B./19°C W.B. (81°F D.B./66°F W.B.), Outdoor: 35°C D.B. (95°F D.B.) Pipe length: 7.5 m (24-9/16 ft.), Level difference: 0 m (0 ft.) | | BTU/h =kW x 3,412 |
| 2.Nominal heating conditions (subject to JIS B8615-2) Indoor: 20°C D.B. (68°F D.B.), Outdoor: 7°C D.B./6°C W.B. (45°F D.B./43°F W.B.) Pipe length: 7.5 m (24-9/16 ft.), Level difference: 0 m (0 ft.) | | cfm =m ³ /min x 35.31 |
| 3.Nominal heating conditions (subject to JIS B8615-2) Indoor: 20°C D.B. (68°F D.B.), Outdoor: 7°C D.B./6°C W.B. (45°F D.B./43°F W.B.) Pipe length: 7.5 m (24-9/16 ft.), Level difference: 0 m (0 ft.) Eurovent registered | | lbs =kg/0.4536 |
| 4.Cooling mode/Heating mode | | |
| 5.The sound pressure level measured by the conventional method in JIS for reference purpose. | | |
| 6.External static pressure option is available (30 Pa, 60 Pa, 80 Pa/3.1 mmH ₂ O, 6.1 mmH ₂ O, 8.2 mmH ₂ O). Consult your dealer about the specification when setting External static pressure option. | | *Above specification data is subject to rounding variation. |

1. SPECIFICATIONS

Y-Series

PUHY-P-Y(S)NW-A1

| Model | | PUHY-P450YNW-A1 (-BS) | | | |
|--------------------------------------------------------|------------------------------|---------------------------------------------------------------------------------------------------------------------------------------------------------------------------------------------------------------------------------------------------------------|------------------------------------------------------------------|----------------|----------------|
| Power source | | 3-phase 4-wire 380-400-415 V 50/60 Hz | | | |
| Cooling capacity (Nominal) | *1 | kW | 50.0 | | |
| | | BTU/h | 170,600 | | |
| | | Power input | kW | 14.57 | |
| | | Current input | A | 24.5-23.3-22.5 | |
| | | EER | kW/kW | 3.43 | |
| | | SEER | kW/kW | 6.48 | |
| Temp. range of cooling | Indoor | W.B. | 15.0~24.0°C (59~75°F) | | |
| | Outdoor | D.B. | -5.0~52.0°C (23~126°F) | | |
| Heating capacity (Max) | *2 | kW | 56.0 | | |
| | | BTU/h | 191,100 | | |
| | | Power input | kW | 14.00 | |
| | | Current input | A | 23.6-22.4-21.6 | |
| | | COP | kW/kW | 4.00 | |
| | (Nominal) | *3 | kW | 50.0 | |
| | | | BTU/h | 170,600 | |
| | | | Power input | kW | 11.68 |
| | | | Current input | A | 19.7-18.7-18.0 |
| | | | COP | kW/kW | 4.28 |
| | | SCOP | kW/kW | 4.00 | |
| Temp. range of heating | Indoor | D.B. | 15.0~27.0°C (59~81°F) | | |
| | Outdoor | W.B. | -20.0~15.5°C (-4~60°F) | | |
| Indoor unit connectable | Total capacity | 50~130% of outdoor unit capacity | | | |
| | Model/Quantity | P10~P250/1~45 | | | |
| Sound pressure level (measured in anechoic room) *4, 5 | | dB <A> | 65.5/69.5 | | |
| Sound power level (measured in anechoic room) *4 | | dB <A> | 84/89 | | |
| Refrigerant piping diameter | Liquid pipe | mm (in.) | 15.88 (5/8) Brazed | | |
| | Gas pipe | mm (in.) | 28.58 (1-1/8) Brazed | | |
| FAN | Type x Quantity | | Propeller fan x 2 | | |
| | Air flow rate | m ³ /min | 305 | | |
| | | L/s | 5,083 | | |
| | | cfm | 10,770 | | |
| | Control, Driving mechanism | | Inverter-control, Direct-driven by motor | | |
| | Motor output | kW | 0.46 x 2 | | |
| | *6 | External static press. | 0 Pa (0 mmH ₂ O) | | |
| Compressor | Type | | Inverter scroll hermetic compressor | | |
| | Starting method | | Inverter | | |
| | Motor output | kW | 11.7 | | |
| | Case heater | kW | - | | |
| | Lubricant | | MEL32 | | |
| External finish | | Pre-coated galvanized steel sheets (+powder coating for -BS type) <MUNSELL 3Y 7.8/1.1 or similar> | | | |
| External dimension H x W x D | | mm | 1,858 (1,798 without legs) x 1,240 x 740 | | |
| | | in. | 73-3/16 (70-13/16 without legs) x 48-7/8 x 29-3/16 | | |
| Protection devices | High pressure protection | | High pressure sensor, High pressure switch at 4.15 MPa (601 psi) | | |
| | Inverter circuit (COMP./FAN) | | Over-current protection | | |
| | Compressor | | - | | |
| | Fan motor | | - | | |
| Refrigerant | Type x original charge | | R410A x 10.8 kg (24 lbs) | | |
| | Control | | LEV and HIC circuit | | |
| Net weight | | kg (lbs) | 293 (646) | | |
| Heat exchanger | | Salt-resistant cross fin & copper tube | | | |
| HIC circuit (HIC: Heat Inter-Changer) | | Copper pipe, tube-in-tube structure | | | |
| Defrosting method | | Auto-defrost mode (Reversed refrigerant cycle, Hot gas) | | | |
| Drawing | External | KB94C1WW | | | |
| | Wiring | KE94L024 | | | |
| Standard attachment | Document | Installation Manual | | | |
| | Accessory | - | | | |
| Optional parts | | Joint: CMY-Y102SS/LS-G2, CMY-Y202S-G2 Header: CMY-Y104/108/1010-G | | | |
| Remarks | | Details on foundation work, duct work, insulation work, electrical wiring, power source switch, and other items shall be referred to the Installation Manual. Due to continuing improvement, above specifications may be subject to change without notice. | | | |

Notes:

- Nominal cooling conditions (subject to JIS B8615-2)
Indoor: 27°C D.B./19°C W.B. (81°F D.B./66°F W.B.), Outdoor: 35°C D.B. (95°F D.B.)
Pipe length: 7.5 m (24-9/16 ft.), Level difference: 0 m (0 ft.)
- Nominal heating conditions (subject to JIS B8615-2)
Indoor: 20°C D.B. (68°F D.B.), Outdoor: 7°C D.B./6°C W.B. (45°F D.B./43°F W.B.)
Pipe length: 7.5 m (24-9/16 ft.), Level difference: 0 m (0 ft.)
- Nominal heating conditions (subject to JIS B8615-2)
Indoor: 20°C D.B. (68°F D.B.), Outdoor: 7°C D.B./6°C W.B. (45°F D.B./43°F W.B.)
Pipe length: 7.5 m (24-9/16 ft.), Level difference: 0 m (0 ft.)
Eurovent registered
- Cooling mode/Heating mode
- The sound pressure level measured by the conventional method in JIS for reference purpose.
- External static pressure option is available (30 Pa, 60 Pa, 80 Pa/3.1 mmH₂O, 6.1 mmH₂O, 8.2 mmH₂O).
Consult your dealer about the specification when setting External static pressure option.

Unit converter

| | |
|-------|------------------------------|
| BTU/h | =kW x 3,412 |
| cfm | =m ³ /min x 35.31 |
| lbs | =kg/0.4536 |

*Above specification data is subject to rounding variation.

1. SPECIFICATIONS

Y-Series

PUHY-P-Y(S)NW-A1

| Model | | | PUHY-P500YNW-A1 (-BS) | |
|--------------------------------------------------------|------------------------------|-----------------------------|---------------------------------------------------------------------------------------------------------------------------------------------------------------------------------------------------------------------------------------------------------------|----------------|
| Power source | | | 3-phase 4-wire 380-400-415 V 50/60 Hz | |
| Cooling capacity (Nominal) | *1 | kW | 56.0 | |
| | | BTU/h | 191,100 | |
| | Power input | kW | 17.55 | |
| | Current input | A | 29.6-28.1-27.1 | |
| | EER | kW/kW | 3.19 | |
| | SEER | kW/kW | 6.32 | |
| Temp. range of cooling | Indoor | W.B. | 15.0~24.0°C (59~75°F) | |
| | Outdoor | D.B. | -5.0~52.0°C (23~126°F) | |
| Heating capacity (Max) | *2 | kW | 63.0 | |
| | | BTU/h | 215,000 | |
| | Power input | kW | 15.98 | |
| | Current input | A | 26.9-25.6-24.7 | |
| | COP | kW/kW | 3.94 | |
| | (Nominal) | *3 | kW | 56.0 |
| | | | BTU/h | 191,100 |
| | | Power input | kW | 13.42 |
| | | Current input | A | 22.6-21.5-20.7 |
| | | COP | kW/kW | 4.17 |
| SCOP | kW/kW | 3.91 | | |
| Temp. range of heating | Indoor | D.B. | 15.0~27.0°C (59~81°F) | |
| | Outdoor | W.B. | -20.0~15.5°C (-4~60°F) | |
| Indoor unit connectable | Total capacity | | 50~130% of outdoor unit capacity | |
| | Model/Quantity | | P10~P250/1~50 | |
| Sound pressure level (measured in anechoic room) *4, 5 | | dB <A> | 63.5/66.5 | |
| Sound power level (measured in anechoic room) *4 | | dB <A> | 82/85 | |
| Refrigerant piping diameter | Liquid pipe | mm (in.) | 15.88 (5/8) Brazed | |
| | Gas pipe | mm (in.) | 28.58 (1-1/8) Brazed | |
| FAN | Type x Quantity | | Propeller fan x 2 | |
| | Air flow rate | m ³ /min | 365 | |
| | | L/s | 6,083 | |
| | | cfm | 12,888 | |
| | Control, Driving mechanism | | Inverter-control, Direct-driven by motor | |
| | Motor output | kW | 0.92 x 2 | |
| *6 | External static press. | 0 Pa (0 mmH ₂ O) | | |
| Compressor | Type | | Inverter scroll hermetic compressor | |
| | Starting method | | Inverter | |
| | Motor output | kW | 13.3 | |
| | Case heater | kW | - | |
| | Lubricant | | MEL32 | |
| External finish | | | Pre-coated galvanized steel sheets (+powder coating for -BS type) <MUNSELL 3Y 7.8/1.1 or similar> | |
| External dimension H x W x D | | mm | 1,858 (1,798 without legs) x 1,750 x 740 | |
| | | in. | 73-3/16 (70-13/16 without legs) x 68-15/16 x 29-3/16 | |
| Protection devices | High pressure protection | | High pressure sensor, High pressure switch at 4.15 MPa (601 psi) | |
| | Inverter circuit (COMP./FAN) | | Over-current protection | |
| | Compressor | | - | |
| | Fan motor | | - | |
| Refrigerant | Type x original charge | | R410A x 10.8 kg (24 lbs) | |
| | Control | | LEV and HIC circuit | |
| Net weight | | kg (lbs) | 334 (737) | |
| Heat exchanger | | | Salt-resistant cross fin & copper tube | |
| HIC circuit (HIC: Heat Inter-Changer) | | | Copper pipe, tube-in-tube structure | |
| Defrosting method | | | Auto-defrost mode (Reversed refrigerant cycle, Hot gas) | |
| Drawing | External | | KB94C1WX | |
| | Wiring | | KE94L022 | |
| Standard attachment | Document | | Installation Manual | |
| | Accessory | | - | |
| Optional parts | | | Joint: CMY-Y102SS/LS-G2, CMY-Y202S-G2 Header: CMY-Y104/108/1010-G | |
| Remarks | | | Details on foundation work, duct work, insulation work, electrical wiring, power source switch, and other items shall be referred to the Installation Manual. Due to continuing improvement, above specifications may be subject to change without notice. | |

| Notes: | Unit converter |
|-------------------------------------------------------------------------------------------------------------------------------------------------------------------------------------------------------------------------------------------|-------------------------------------------------------------|
| 1.Nominal cooling conditions (subject to JIS B8615-2) Indoor: 27°C D.B./19°C W.B. (81°F D.B./66°F W.B.), Outdoor: 35°C D.B. (95°F D.B.) Pipe length: 7.5 m (24-9/16 ft.), Level difference: 0 m (0 ft.) | BTU/h =kW x 3,412 |
| 2.Nominal heating conditions (subject to JIS B8615-2) Indoor: 20°C D.B. (68°F D.B.), Outdoor: 7°C D.B./6°C W.B. (45°F D.B./43°F W.B.) Pipe length: 7.5 m (24-9/16 ft.), Level difference: 0 m (0 ft.) | cfm =m ³ /min x 35.31 |
| 3.Nominal heating conditions (subject to JIS B8615-2) Indoor: 20°C D.B. (68°F D.B.), Outdoor: 7°C D.B./6°C W.B. (45°F D.B./43°F W.B.) Pipe length: 7.5 m (24-9/16 ft.), Level difference: 0 m (0 ft.) Eurovent registered | lbs =kg/0.4536 |
| 4.Cooling mode/Heating mode | |
| 5.The sound pressure level measured by the conventional method in JIS for reference purpose. | |
| 6.External static pressure option is available (30 Pa, 60 Pa, 80 Pa/3.1 mmH ₂ O, 6.1 mmH ₂ O, 8.2 mmH ₂ O). Consult your dealer about the specification when setting External static pressure option. | *Above specification data is subject to rounding variation. |

1. SPECIFICATIONS

| | | | | | |
|--------------------------------------------------------|------------------------|-------------|---------------------------------------|-----------------------|--|
| Model | | | PUHY-P400YSNW-A1 (-BS) | | |
| Power source | | | 3-phase 4-wire 380-400-415 V 50/60 Hz | | |
| Cooling capacity (Nominal) | *1 | kW | 45.0 | | |
| | | BTU/h | 153,500 | | |
| | Power input | kW | 9.97 | | |
| | | A | 16.8-15.9-15.4 | | |
| | EER | kW/kW | 4.51 | | |
| | SEER | kW/kW | 7.42 | | |
| Temp. range of cooling | Indoor | W.B. | 15.0-24.0°C (59-75°F) | | |
| | Outdoor | D.B. | -5.0-52.0°C (23-126°F) | | |
| Heating capacity (Max) | *2 | kW | 50.0 | | |
| | | BTU/h | 170,600 | | |
| | Power input | kW | 10.52 | | |
| | | A | 17.7-16.8-16.2 | | |
| | COP | kW/kW | 4.75 | | |
| | (Nominal) | *3 | kW | 45.0 | |
| | | | BTU/h | 153,500 | |
| | | Power input | kW | 9.03 | |
| | | | A | 15.2-14.4-13.9 | |
| | | COP | kW/kW | 4.98 | |
| | | SCOP | kW/kW | 4.27 | |
| | Temp. range of heating | Indoor | D.B. | 15.0-27.0°C (59-81°F) | |
| Outdoor | | W.B. | -20.0-15.5°C (-4-60°F) | | |
| Indoor unit connectable | Total capacity | | 50-130% of outdoor unit capacity | | |
| | Model/Quantity | | P10-P250/1-40 | | |
| Sound pressure level (measured in anechoic room) *4, 5 | | dB <A> | 61.0/62.0 | | |
| Sound power level (measured in anechoic room) *4 | | dB <A> | 78/80 | | |
| Refrigerant piping diameter | Liquid pipe | mm (in.) | 12.7 (1/2) Brazed | | |
| | Gas pipe | mm (in.) | 28.58 (1-1/8) Brazed | | |

| | | | | | | |
|---------------------------------------|------------------------------|-------------------------------------|---------------------------------------------------------------------------------------------------------------------------------------------------------------------------------------------------------------------------------------------------------------|-------------------------------------|------------------------------------------------------------------------------------------------------|----------|
| Set Model | | | PUHY-P200YNW-A1 (-BS) | | PUHY-P200YNW-A1 (-BS) | |
| FAN | Type x Quantity | | Propeller fan x 1 | | Propeller fan x 1 | |
| | Air flow rate | m ³ /min | 170 | | 170 | |
| | | L/s | 2,833 | | 2,833 | |
| | | cfm | 6,003 | | 6,003 | |
| | Control, Driving mechanism | | Inverter-control, Direct-driven by motor | | Inverter-control, Direct-driven by motor | |
| | *6 | Motor output | kW | 0.92 x 1 | | 0.92 x 1 |
| External static press. | | 0 Pa (0 mmH ₂ O) | | 0 Pa (0 mmH ₂ O) | | |
| Type | | Inverter scroll hermetic compressor | | Inverter scroll hermetic compressor | | |
| Compressor | Starting method | | Inverter | | Inverter | |
| | Motor output | kW | 3.5 | | 3.5 | |
| | Case heater | kW | - | | - | |
| | Lubricant | | MEL32 | | MEL32 | |
| External finish | | | Pre-coated galvanized steel sheets (+powder coating for -BS type) <MUNSELL 3Y 7.8/1.1 or similar> | | Pre-coated galvanized steel sheets (+powder coating for -BS type) <MUNSELL 3Y 7.8/1.1 or similar> | |
| External dimension H x W x D | | | mm 1,858 (1,798 without legs) x 920 x 740 73-3/16 (70-13/16 without legs) x 36-1/4 x 29-3/16 | | mm 1,858 (1,798 without legs) x 920 x 740 73-3/16 (70-13/16 without legs) x 36-1/4 x 29-3/16 | |
| Protection devices | High pressure protection | | High pressure sensor, High pressure switch at 4.15 MPa (601 psi) | | High pressure sensor, High pressure switch at 4.15 MPa (601 psi) | |
| | Inverter circuit (COMP./FAN) | | Over-current protection | | Over-current protection | |
| | Compressor | | - | | - | |
| | Fan motor | | - | | - | |
| Refrigerant | Type x original charge | | R410A x 6.5 kg (15 lbs) | | R410A x 6.5 kg (15 lbs) | |
| | Control | | LEV and HIC circuit | | | |
| Net weight | | kg (lbs) | 213 (470) | | 213 (470) | |
| Heat exchanger | | | Salt-resistant cross fin & copper tube | | Salt-resistant cross fin & copper tube | |
| HIC circuit (HIC: Heat Inter-Changer) | | | Copper pipe, tube-in-tube structure | | Copper pipe, tube-in-tube structure | |
| Pipe between unit and distributor | Liquid pipe | mm (in.) | 9.52 (3/8) Brazed | | 9.52 (3/8) Brazed | |
| | Gas pipe | mm (in.) | 22.2 (7/8) Brazed | | 22.2 (7/8) Brazed | |
| Defrosting method | | | Auto-defrost mode (Reversed refrigerant cycle, Hot gas) | | | |
| Drawing | External | | KB94C1WY | | | |
| | Wiring | | KE94L023 | | KE94L023 | |
| Standard attachment | Document | | Installation Manual | | | |
| | Accessory | | - | | | |
| Optional parts | | | Outdoor Twinning kit: CMY-Y100VBK3 Joint: CMY-Y102SS/LS-G2, CMY-Y202S/302S-G2 Header: CMY-104/108/1010-G | | | |
| Remarks | | | Details on foundation work, duct work, insulation work, electrical wiring, power source switch, and other items shall be referred to the Installation Manual. Due to continuing improvement, above specifications may be subject to change without notice. | | | |

| | | | | |
|-------------------------------------------------------------------------------------------------------------------------------------------------------------------------------------------------------------------------------------------|--|--|-------------------------------------------------------------|--|
| Notes: | | | Unit converter | |
| 1.Nominal cooling conditions (subject to JIS B8615-2) Indoor: 27°C D.B./19°C W.B. (81°F D.B./66°F W.B.), Outdoor: 35°C D.B. (95°F D.B.) Pipe length: 7.5 m (24-9/16 ft.), Level difference: 0 m (0 ft.) | | | BTU/h =kW x 3,412 | |
| 2.Nominal heating conditions (subject to JIS B8615-2) Indoor: 20°C D.B. (68°F D.B.), Outdoor: 7°C D.B./6°C W.B. (45°F D.B./43°F W.B.) Pipe length: 7.5 m (24-9/16 ft.), Level difference: 0 m (0 ft.) | | | cfm =m ³ /min x 35.31 | |
| 3.Nominal heating conditions (subject to JIS B8615-2) Indoor: 20°C D.B. (68°F D.B.), Outdoor: 7°C D.B./6°C W.B. (45°F D.B./43°F W.B.) Pipe length: 7.5 m (24-9/16 ft.), Level difference: 0 m (0 ft.) | | | lbs =kg/0.4536 | |
| 4.Cooling mode/Heating mode | | | | |
| 5.The sound pressure level measured by the conventional method in JIS for reference purpose. | | | | |
| 6.External static pressure option is available (30 Pa, 60 Pa, 80 Pa/3.1 mmH ₂ O, 6.1 mmH ₂ O, 8.2 mmH ₂ O). Consult your dealer about the specification when setting External static pressure option. | | | *Above specification data is subject to rounding variation. | |

1. SPECIFICATIONS

Y-Series

PUHY-P-Y(S)NW-A1

| Model | | | PUHY-P450YSNW-A1 (-BS) | | |
|--------------------------------------------------------|---------------------------------------|----------------------------------|------------------------|----------------|--|
| Power source | 3-phase 4-wire 380-400-415 V 50/60 Hz | | | | |
| Cooling capacity (Nominal) | *1 | kW | 50.0 | | |
| | | BTU/h | 170,600 | | |
| | Power input | kW | 12.16 | | |
| | Current input | A | 20.5-19.5-18.7 | | |
| | EER | kW/kW | 4.11 | | |
| | SEER | kW/kW | 7.19 | | |
| Temp. range of cooling | Indoor | W.B. | 15.0~24.0°C (59~75°F) | | |
| | Outdoor | D.B. | -5.0~52.0°C (23~126°F) | | |
| Heating capacity (Max) | *2 | kW | 56.0 | | |
| | | BTU/h | 191,100 | | |
| | Power input | kW | 12.55 | | |
| | Current input | A | 21.1-20.1-19.3 | | |
| | COP | kW/kW | 4.46 | | |
| | (Nominal) | *3 | kW | 50.0 | |
| | | | BTU/h | 170,600 | |
| | | Power input | kW | 10.59 | |
| | | Current input | A | 17.8-16.9-16.3 | |
| | | COP | kW/kW | 4.72 | |
| SCOP | | kW/kW | 4.16 | | |
| Temp. range of heating | Indoor | D.B. | 15.0~27.0°C (59~81°F) | | |
| | Outdoor | W.B. | -20.0~15.5°C (-4~60°F) | | |
| Indoor unit connectable | Total capacity | 50~130% of outdoor unit capacity | | | |
| | Model/Quantity | P10~P250/1~45 | | | |
| Sound pressure level (measured in anechoic room) *4, 5 | dB <A> | 62.0/63.0 | | | |
| Sound power level (measured in anechoic room) *4 | dB <A> | 80/82 | | | |
| Refrigerant piping diameter | Liquid pipe | mm (in.) | 15.88 (5/8) Brazed | | |
| | Gas pipe | mm (in.) | 28.58 (1-1/8) Brazed | | |

| Set Model | | | PUHY-P200YNW-A1 (-BS) | | PUHY-P250YNW-A1 (-BS) | |
|---------------------------------------|---------------------------------------------------------------------------------------------------------------------------------------------------------------------------------------------------------------------------------------------------------------|------------------------------------------------------------------|------------------------------------------------------------------------------------------------------|------------------------------------------------------------------|-----------------------|--|
| FAN | Type x Quantity | Propeller fan x 1 | | Propeller fan x 1 | | |
| | Air flow rate | m ³ /min | 170 | | 185 | |
| | | L/s | 2,833 | | 3,083 | |
| | | cfm | 6,003 | | 6,532 | |
| | Control, Driving mechanism | Inverter-control, Direct-driven by motor | | Inverter-control, Direct-driven by motor | | |
| | Motor output | kW | 0.92 x 1 | | 0.92 x 1 | |
| *6 External static press. | 0 Pa (0 mmH ₂ O) | | 0 Pa (0 mmH ₂ O) | | | |
| Compressor | Type | Inverter scroll hermetic compressor | | Inverter scroll hermetic compressor | | |
| | Starting method | Inverter | | Inverter | | |
| | Motor output | kW | 3.5 | | 5.3 | |
| | Case heater | kW | - | | - | |
| | Lubricant | MEL32 | | MEL32 | | |
| External finish | Pre-coated galvanized steel sheets (+powder coating for -BS type) <MUNSELL 3Y 7.8/1.1 or similar> | | Pre-coated galvanized steel sheets (+powder coating for -BS type) <MUNSELL 3Y 7.8/1.1 or similar> | | | |
| External dimension H x W x D | mm | 1,858 (1,798 without legs) x 920 x 740 | | 1,858 (1,798 without legs) x 920 x 740 | | |
| | in. | 73-3/16 (70-13/16 without legs) x 36-1/4 x 29-3/16 | | 73-3/16 (70-13/16 without legs) x 36-1/4 x 29-3/16 | | |
| Protection devices | High pressure protection | High pressure sensor, High pressure switch at 4.15 MPa (601 psi) | | High pressure sensor, High pressure switch at 4.15 MPa (601 psi) | | |
| | Inverter circuit (COMP./FAN) | Over-current protection | | Over-current protection | | |
| | Compressor | - | | - | | |
| | Fan motor | - | | - | | |
| Refrigerant | Type x original charge | R410A x 6.5 kg (15 lbs) | | R410A x 6.5 kg (15 lbs) | | |
| | Control | LEV and HIC circuit | | | | |
| Net weight | kg (lbs) | 213 (470) | | 213 (470) | | |
| Heat exchanger | Salt-resistant cross fin & copper tube | | Salt-resistant cross fin & copper tube | | | |
| HIC circuit (HIC: Heat Inter-Changer) | Copper pipe, tube-in-tube structure | | Copper pipe, tube-in-tube structure | | | |
| Pipe between unit and distributor | Liquid pipe | mm (in.) | 9.52 (3/8) Brazed | | 9.52 (3/8) Brazed | |
| | Gas pipe | mm (in.) | 22.2 (7/8) Brazed | | 22.2 (7/8) Brazed | |
| Defrosting method | Auto-defrost mode (Reversed refrigerant cycle, Hot gas) | | | | | |
| Drawing | External | KB94C1WY | | | | |
| | Wiring | KE94L023 | | KE94L023 | | |
| Standard attachment | Document | Installation Manual | | | | |
| | Accessory | - | | | | |
| Optional parts | Outdoor Twinning kit: CMY-Y100VBK3 Joint: CMY-Y102SS/LS-G2, CMY-Y202S/302S-G2 Header: CMY-Y104/108/1010-G | | | | | |
| Remarks | Details on foundation work, duct work, insulation work, electrical wiring, power source switch, and other items shall be referred to the Installation Manual. Due to continuing improvement, above specifications may be subject to change without notice. | | | | | |

| Notes: | Unit converter |
|--------------------------------------------------------------------------------------------------------------------------------------------------------------------------------------------------------------------------------------------|-------------------------------------------------------------|
| 1. Nominal cooling conditions (subject to JIS B8615-2) Indoor: 27°C D.B./19°C W.B. (81°F D.B./66°F W.B.), Outdoor: 35°C D.B. (95°F D.B.) Pipe length: 7.5 m (24-9/16 ft.), Level difference: 0 m (0 ft.) | BTU/h =kW x 3,412 |
| 2. Nominal heating conditions (subject to JIS B8615-2) Indoor: 20°C D.B. (68°F D.B.), Outdoor: 7°C D.B./6°C W.B. (45°F D.B./43°F W.B.) Pipe length: 7.5 m (24-9/16 ft.), Level difference: 0 m (0 ft.) | cfm =m ³ /min x 35.31 |
| 3. Nominal heating conditions (subject to JIS B8615-2) Indoor: 20°C D.B. (68°F D.B.), Outdoor: 7°C D.B./6°C W.B. (45°F D.B./43°F W.B.) Pipe length: 7.5 m (24-9/16 ft.), Level difference: 0 m (0 ft.) Eurovent registered | lbs =kg/0.4536 |
| 4. Cooling mode/Heating mode | |
| 5. The sound pressure level measured by the conventional method in JIS for reference purpose. | |
| 6. External static pressure option is available (30 Pa, 60 Pa, 80 Pa/3.1 mmH ₂ O, 6.1 mmH ₂ O, 8.2 mmH ₂ O). Consult your dealer about the specification when setting External static pressure option. | *Above specification data is subject to rounding variation. |

1. SPECIFICATIONS

Y-Series

PUHY-P-Y(S)NW-A1

| Model | | | PUHY-P500YSNW-A1 (-BS) | | |
|--------------------------------------------------------|----------------|----------------------------------|---------------------------------------|----------------|--|
| Power source | | | 3-phase 4-wire 380-400-415 V 50/60 Hz | | |
| Cooling capacity (Nominal) | | *1 kW | 56.0 | | |
| | | BTU/h | 191,100 | | |
| | | Power input kW | 14.73 | | |
| | | Current input A | 24.8-23.6-22.7 | | |
| | | EER | 3.80 | | |
| Temp. range of cooling | Indoor | W.B. | 15.0~24.0°C (59~75°F) | | |
| | | D.B. | -5.0~52.0°C (23~126°F) | | |
| | | Outdoor | | | |
| Heating capacity (Max) | | *2 kW | 63.0 | | |
| | | BTU/h | 215,000 | | |
| | | Power input kW | 14.89 | | |
| | | Current input A | 25.1-23.8-23.0 | | |
| | | COP | 4.23 | | |
| | (Nominal) | | *3 kW | 56.0 | |
| | | | BTU/h | 191,100 | |
| | | | Power input kW | 12.41 | |
| | | | Current input A | 20.9-19.9-19.1 | |
| | | | COP | 4.51 | |
| Temp. range of heating | Indoor | D.B. | 15.0~27.0°C (59~81°F) | | |
| | | W.B. | -20.0~15.5°C (-4~60°F) | | |
| Indoor unit connectable | Total capacity | 50~130% of outdoor unit capacity | | | |
| | Model/Quantity | P10-P250/1~50 | | | |
| Sound pressure level (measured in anechoic room) *4, 5 | | dB <A> | 63.0/64.0 | | |
| Sound power level (measured in anechoic room) *4 | | dB <A> | 81/83 | | |
| Refrigerant piping diameter | Liquid pipe | mm (in.) | 15.88 (5/8) Brazed | | |
| | Gas pipe | mm (in.) | 28.58 (1-1/8) Brazed | | |

| Set Model | | | PUHY-P250YNW-A1 (-BS) | | PUHY-P250YNW-A1 (-BS) | |
|---------------------------------------|------------------------------|-----------------------------|---------------------------------------------------------------------------------------------------------------------------------------------------------------------------------------------------------------------------------------------------------------|-----------------------------|------------------------------------------------------------------------------------------------------|----------|
| Model | | | Propeller fan x 1 | | Propeller fan x 1 | |
| FAN | Type x Quantity | | 185 | | 185 | |
| | Air flow rate | m ³ /min | 3,083 | | 3,083 | |
| | | L/s | 6,532 | | 6,532 | |
| | | cfm | | | | |
| | Control, Driving mechanism | | Inverter-control, Direct-driven by motor | | Inverter-control, Direct-driven by motor | |
| | Motor output | kW | | 0.92 x 1 | | 0.92 x 1 |
| External static press. | | 0 Pa (0 mmH ₂ O) | | 0 Pa (0 mmH ₂ O) | | |
| | | | | | | |
| Compressor | Type | | Inverter scroll hermetic compressor | | Inverter scroll hermetic compressor | |
| | Starting method | | Inverter | | Inverter | |
| | Motor output | kW | 5.3 | | 5.3 | |
| | Case heater | kW | - | | - | |
| | Lubricant | | MEL32 | | MEL32 | |
| External finish | | | Pre-coated galvanized steel sheets (+powder coating for -BS type) <MUNSELL 3Y 7.8/1.1 or similar> | | Pre-coated galvanized steel sheets (+powder coating for -BS type) <MUNSELL 3Y 7.8/1.1 or similar> | |
| External dimension H x W x D | | | mm 1,858 (1,798 without legs) x 920 x 740 | | mm 1,858 (1,798 without legs) x 920 x 740 | |
| | | | in. 73-3/16 (70-13/16 without legs) x 36-1/4 x 29-3/16 | | in. 73-3/16 (70-13/16 without legs) x 36-1/4 x 29-3/16 | |
| Protection devices | High pressure protection | | High pressure sensor, High pressure switch at 4.15 MPa (601 psi) | | High pressure sensor, High pressure switch at 4.15 MPa (601 psi) | |
| | Inverter circuit (COMP./FAN) | | Over-current protection | | Over-current protection | |
| | Compressor | | - | | - | |
| | Fan motor | | - | | - | |
| Refrigerant | Type x original charge | | R410A x 6.5 kg (15 lbs) | | R410A x 6.5 kg (15 lbs) | |
| | Control | | LEV and HIC circuit | | | |
| Net weight | | | kg (lbs) 213 (470) | | kg (lbs) 213 (470) | |
| Heat exchanger | | | Salt-resistant cross fin & copper tube | | Salt-resistant cross fin & copper tube | |
| HIC circuit (HIC: Heat Inter-Changer) | | | Copper pipe, tube-in-tube structure | | Copper pipe, tube-in-tube structure | |
| Pipe between unit and distributor | Liquid pipe | mm (in.) | 9.52 (3/8) Brazed | | 9.52 (3/8) Brazed | |
| | Gas pipe | mm (in.) | 22.2 (7/8) Brazed | | 22.2 (7/8) Brazed | |
| Defrosting method | | | Auto-defrost mode (Reversed refrigerant cycle, Hot gas) | | | |
| Drawing | External | | KB94C1WY | | | |
| | Wiring | | KE94L023 | | KE94L023 | |
| Standard attachment | Document | | Installation Manual | | | |
| | Accessory | | - | | | |
| Optional parts | | | Outdoor Twinning kit: CMY-Y100VBK3 Joint: CMY-Y102SS/LS-G2, CMY-Y202S/302S-G2 Header: CMY-Y104/108/1010-G | | | |
| Remarks | | | Details on foundation work, duct work, insulation work, electrical wiring, power source switch, and other items shall be referred to the Installation Manual. Due to continuing improvement, above specifications may be subject to change without notice. | | | |

| Notes: | | Unit converter |
|-------------------------------------------------------------------------------------------------------------------------------------------------------------------------------------------------------------------------------------------|--|-------------------------------------------------------------|
| 1.Nominal cooling conditions (subject to JIS B8615-2) Indoor: 27°C D.B./19°C W.B. (81°F D.B./66°F W.B.), Outdoor: 35°C D.B. (95°F D.B.) Pipe length: 7.5 m (24-9/16 ft.), Level difference: 0 m (0 ft.) | | BTU/h =kW x 3,412 |
| 2.Nominal heating conditions (subject to JIS B8615-2) Indoor: 20°C D.B. (68°F D.B.), Outdoor: 7°C D.B./6°C W.B. (45°F D.B./43°F W.B.) Pipe length: 7.5 m (24-9/16 ft.), Level difference: 0 m (0 ft.) | | cfm =m ³ /min x 35.31 |
| 3.Nominal heating conditions (subject to JIS B8615-2) Indoor: 20°C D.B. (68°F D.B.), Outdoor: 7°C D.B./6°C W.B. (45°F D.B./43°F W.B.) Pipe length: 7.5 m (24-9/16 ft.), Level difference: 0 m (0 ft.) Eurovent registered | | lbs =kg/0.4536 |
| 4.Cooling mode/Heating mode | | |
| 5.The sound pressure level measured by the conventional method in JIS for reference purpose. | | |
| 6.External static pressure option is available (30 Pa, 60 Pa, 80 Pa/3.1 mmH ₂ O, 6.1 mmH ₂ O, 8.2 mmH ₂ O). Consult your dealer about the specification when setting External static pressure option. | | *Above specification data is subject to rounding variation. |

1. SPECIFICATIONS

Y-Series

PUHY-P-Y(S)NW-A1

| Model | | | PUHY-P550YSNW-A1 (-BS) | | |
|--------------------------------------------------------|---------------------------------------|----------------------------------|------------------------|----------------|--|
| Power source | 3-phase 4-wire 380-400-415 V 50/60 Hz | | | | |
| Cooling capacity (Nominal) | *1 | kW | 63.0 | | |
| | | BTU/h | 215,000 | | |
| | Power input | kW | 16.84 | | |
| | Current input | A | 28.4-27.0-26.0 | | |
| | EER | kW/kW | 3.74 | | |
| | SEER | kW/kW | 6.76 | | |
| Temp. range of cooling | Indoor | W.B. | 15.0~24.0°C (59~75°F) | | |
| | Outdoor | D.B. | -5.0~52.0°C (23~126°F) | | |
| Heating capacity (Max) | *2 | kW | 69.0 | | |
| | | BTU/h | 235,400 | | |
| | Power input | kW | 16.15 | | |
| | Current input | A | 27.2-25.9-24.9 | | |
| | COP | kW/kW | 4.27 | | |
| | (Nominal) | *3 | kW | 63.0 | |
| | | | BTU/h | 215,000 | |
| | | Power input | kW | 13.87 | |
| | | Current input | A | 23.4-22.2-21.4 | |
| | | COP | kW/kW | 4.54 | |
| Temp. range of heating | Indoor | D.B. | 15.0~27.0°C (59~81°F) | | |
| | Outdoor | W.B. | -20.0~15.5°C (-4~60°F) | | |
| Indoor unit connectable | Total capacity | 50~130% of outdoor unit capacity | | | |
| | Model/Quantity | P10~P250/2-50 | | | |
| Sound pressure level (measured in anechoic room) *4, 5 | dB <A> | 63.5/66.0 | | | |
| Sound power level (measured in anechoic room) *4 | dB <A> | 82/85 | | | |
| Refrigerant piping diameter | Liquid pipe | mm (in.) | 15.88 (5/8) Brazed | | |
| | Gas pipe | mm (in.) | 28.58 (1-1/8) Brazed | | |

| Set Model | | | PUHY-P250YNW-A1 (-BS) | | PUHY-P300YNW-A1 (-BS) | |
|---------------------------------------|---------------------------------------------------------------------------------------------------------------------------------------------------------------------------------------------------------------------------------------------------------------|------------------------------------------------------------------|------------------------------------------------------------------------------------------------------|------------------------------------------------------------------|-----------------------|--|
| FAN | Type x Quantity | Propeller fan x 1 | | Propeller fan x 1 | | |
| | Air flow rate | m ³ /min | 185 | | 240 | |
| | | L/s | 3,083 | | 4,000 | |
| | | cfm | 6,532 | | 8,474 | |
| | Control, Driving mechanism | Inverter-control, Direct-driven by motor | | Inverter-control, Direct-driven by motor | | |
| | Motor output | kW | 0.92 x 1 | | 0.92 x 1 | |
| *6 External static press. | 0 Pa (0 mmH ₂ O) | | 0 Pa (0 mmH ₂ O) | | | |
| Compressor | Type | Inverter scroll hermetic compressor | | Inverter scroll hermetic compressor | | |
| | Starting method | Inverter | | Inverter | | |
| | Motor output | kW | 5.3 | | 6.7 | |
| | Case heater | kW | - | | - | |
| | Lubricant | MEL32 | | MEL32 | | |
| External finish | Pre-coated galvanized steel sheets (+powder coating for -BS type) <MUNSELL 3Y 7.8/1.1 or similar> | | Pre-coated galvanized steel sheets (+powder coating for -BS type) <MUNSELL 3Y 7.8/1.1 or similar> | | | |
| External dimension H x W x D | mm | 1,858 (1,798 without legs) x 920 x 740 | | 1,858 (1,798 without legs) x 920 x 740 | | |
| | in. | 73-3/16 (70-13/16 without legs) x 36-1/4 x 29-3/16 | | 73-3/16 (70-13/16 without legs) x 36-1/4 x 29-3/16 | | |
| Protection devices | High pressure protection | High pressure sensor, High pressure switch at 4.15 MPa (601 psi) | | High pressure sensor, High pressure switch at 4.15 MPa (601 psi) | | |
| | Inverter circuit (COMP./FAN) | Over-current protection | | Over-current protection | | |
| | Compressor | - | | - | | |
| | Fan motor | - | | - | | |
| Refrigerant | Type x original charge | R410A x 6.5 kg (15 lbs) | | R410A x 6.5 kg (15 lbs) | | |
| | Control | LEV and HIC circuit | | | | |
| Net weight | kg (lbs) | 213 (470) | | 226 (499) | | |
| Heat exchanger | Salt-resistant cross fin & copper tube | | Salt-resistant cross fin & copper tube | | | |
| HIC circuit (HIC: Heat Inter-Changer) | Copper pipe, tube-in-tube structure | | Copper pipe, tube-in-tube structure | | | |
| Pipe between unit and distributor | Liquid pipe | mm (in.) | 9.52 (3/8) Brazed | | 12.7 (1/2) Brazed | |
| | Gas pipe | mm (in.) | 22.2 (7/8) Brazed | | 22.2 (7/8) Brazed | |
| Defrosting method | Auto-defrost mode (Reversed refrigerant cycle, Hot gas) | | | | | |
| Drawing | External | KB94C1WY | | | | |
| | Wiring | KE94L023 | | KE94L023 | | |
| Standard attachment | Document | Installation Manual | | | | |
| | Accessory | - | | | | |
| Optional parts | Outdoor Twinning kit: CMY-Y100VBK3 Joint: CMY-Y102SS/LS-G2, CMY-Y202S/302S-G2 Header: CMY-Y104/108/1010-G | | | | | |
| Remarks | Details on foundation work, duct work, insulation work, electrical wiring, power source switch, and other items shall be referred to the Installation Manual. Due to continuing improvement, above specifications may be subject to change without notice. | | | | | |

| Notes: | Unit converter |
|--------------------------------------------------------------------------------------------------------------------------------------------------------------------------------------------------------------------------------------------|-------------------------------------------------------------|
| 1. Nominal cooling conditions (subject to JIS B8615-2) Indoor: 27°C D.B./19°C W.B. (81°F D.B./66°F W.B.), Outdoor: 35°C D.B. (95°F D.B.) Pipe length: 7.5 m (24-9/16 ft.), Level difference: 0 m (0 ft.) | BTU/h =kW x 3,412 |
| 2. Nominal heating conditions (subject to JIS B8615-2) Indoor: 20°C D.B. (68°F D.B.), Outdoor: 7°C D.B./6°C W.B. (45°F D.B./43°F W.B.) Pipe length: 7.5 m (24-9/16 ft.), Level difference: 0 m (0 ft.) | cfm =m ³ /min x 35.31 |
| 3. Nominal heating conditions (subject to JIS B8615-2) Indoor: 20°C D.B. (68°F D.B.), Outdoor: 7°C D.B./6°C W.B. (45°F D.B./43°F W.B.) Pipe length: 7.5 m (24-9/16 ft.), Level difference: 0 m (0 ft.) Eurovent registered | lbs =kg/0.4536 |
| 4. Cooling mode/Heating mode | |
| 5. The sound pressure level measured by the conventional method in JIS for reference purpose. | |
| 6. External static pressure option is available (30 Pa, 60 Pa, 80 Pa/3.1 mmH ₂ O, 6.1 mmH ₂ O, 8.2 mmH ₂ O). Consult your dealer about the specification when setting External static pressure option. | *Above specification data is subject to rounding variation. |

1. SPECIFICATIONS

Y-Series

PUHY-P-Y(S)NW-A1

| Model | | | PUHY-P600YSNW-A1 (-BS) | | |
|--------------------------------------------------------|----------------|----------------------------------|---------------------------------------|----------------|--|
| Power source | | | 3-phase 4-wire 380-400-415 V 50/60 Hz | | |
| Cooling capacity (Nominal) | | *1 kW | 69.0 | | |
| | | BTU/h | 235,400 | | |
| | | Power input kW | 18.69 | | |
| | | Current input A | 31.5-29.9-28.8 | | |
| | | EER | 3.69 | | |
| | | SEER | 6.57 | | |
| Temp. range of cooling | Indoor | W.B. | 15.0~24.0°C (59~75°F) | | |
| | Outdoor | D.B. | -5.0~52.0°C (23~126°F) | | |
| Heating capacity (Max) | | *2 kW | 76.5 | | |
| | | BTU/h | 261,000 | | |
| | | Power input kW | 17.83 | | |
| | | Current input A | 30.0-28.5-27.5 | | |
| | | COP | 4.29 | | |
| | (Nominal) | | *3 kW | 69.0 | |
| | | | BTU/h | 235,400 | |
| | | | Power input kW | 15.13 | |
| | | | Current input A | 25.5-24.2-23.3 | |
| | | | COP | 4.56 | |
| | | SCOP | 4.03 | | |
| Temp. range of heating | Indoor | D.B. | 15.0~27.0°C (59~81°F) | | |
| | Outdoor | W.B. | -20.0~15.5°C (-4~60°F) | | |
| Indoor unit connectable | Total capacity | 50~130% of outdoor unit capacity | | | |
| | Model/Quantity | P10-P250/2-50 | | | |
| Sound pressure level (measured in anechoic room) *4, 5 | | dB <A> | 64.0/67.5 | | |
| Sound power level (measured in anechoic room) *4 | | dB <A> | 83/87 | | |
| Refrigerant piping diameter | Liquid pipe | mm (in.) | 15.88 (5/8) Brazed | | |
| | Gas pipe | mm (in.) | 28.58 (1-1/8) Brazed | | |

| Set Model | | | PUHY-P300YNW-A1 (-BS) | | PUHY-P300YNW-A1 (-BS) | |
|---------------------------------------|------------------------------|-----------------------------|---------------------------------------------------------------------------------------------------------------------------------------------------------------------------------------------------------------------------------------------------------------|-----------------------------|------------------------------------------------------------------------------------------------------|----------|
| FAN | Type x Quantity | | Propeller fan x 1 | | Propeller fan x 1 | |
| | Air flow rate | m ³ /min | 240 | | 240 | |
| | | L/s | 4,000 | | 4,000 | |
| | | cfm | 8,474 | | 8,474 | |
| | Control, Driving mechanism | | Inverter-control, Direct-driven by motor | | Inverter-control, Direct-driven by motor | |
| | Motor output | kW | | 0.92 x 1 | | 0.92 x 1 |
| External static press. | | 0 Pa (0 mmH ₂ O) | | 0 Pa (0 mmH ₂ O) | | |
| | | | | | | |
| Compressor | Type | | Inverter scroll hermetic compressor | | Inverter scroll hermetic compressor | |
| | Starting method | | Inverter | | Inverter | |
| | Motor output | kW | 6.7 | | 6.7 | |
| | Case heater | kW | - | | - | |
| Lubricant | | MEL32 | | MEL32 | | |
| External finish | | | Pre-coated galvanized steel sheets (+powder coating for -BS type) <MUNSELL 3Y 7.8/1.1 or similar> | | Pre-coated galvanized steel sheets (+powder coating for -BS type) <MUNSELL 3Y 7.8/1.1 or similar> | |
| External dimension H x W x D | | | mm | | 1,858 (1,798 without legs) x 920 x 740 | |
| | | | in. | | 73-3/16 (70-13/16 without legs) x 36-1/4 x 29-3/16 | |
| Protection devices | High pressure protection | | High pressure sensor, High pressure switch at 4.15 MPa (601 psi) | | High pressure sensor, High pressure switch at 4.15 MPa (601 psi) | |
| | Inverter circuit (COMP./FAN) | | Over-current protection | | Over-current protection | |
| | Compressor | | - | | - | |
| | Fan motor | | - | | - | |
| Refrigerant | Type x original charge | | R410A x 6.5 kg (15 lbs) | | R410A x 6.5 kg (15 lbs) | |
| | Control | | LEV and HIC circuit | | | |
| Net weight | | | kg (lbs) | | 226 (499) | |
| Heat exchanger | | | Salt-resistant cross fin & copper tube | | Salt-resistant cross fin & copper tube | |
| HIC circuit (HIC: Heat Inter-Changer) | | | Copper pipe, tube-in-tube structure | | Copper pipe, tube-in-tube structure | |
| Pipe between unit and distributor | Liquid pipe | mm (in.) | 12.7 (1/2) Brazed | | 12.7 (1/2) Brazed | |
| | Gas pipe | mm (in.) | 22.2 (7/8) Brazed | | 22.2 (7/8) Brazed | |
| Defrosting method | | | Auto-defrost mode (Reversed refrigerant cycle, Hot gas) | | | |
| Drawing | External | | KB94C1WY | | | |
| | Wiring | | KE94L023 | | KE94L023 | |
| Standard attachment | Document | | Installation Manual | | | |
| | Accessory | | - | | | |
| Optional parts | | | Outdoor Twinning kit: CMY-Y100VBK3 Joint: CMY-Y102SS/LS-G2, CMY-Y202S/302S-G2 Header: CMY-Y104/108/1010-G | | | |
| Remarks | | | Details on foundation work, duct work, insulation work, electrical wiring, power source switch, and other items shall be referred to the Installation Manual. Due to continuing improvement, above specifications may be subject to change without notice. | | | |

| Notes: | | Unit converter |
|-------------------------------------------------------------------------------------------------------------------------------------------------------------------------------------------------------------------------------------------|--|-------------------------------------------------------------|
| 1.Nominal cooling conditions (subject to JIS B8615-2) Indoor: 27°C D.B./19°C W.B. (81°F D.B./66°F W.B.), Outdoor: 35°C D.B. (95°F D.B.) Pipe length: 7.5 m (24-9/16 ft.), Level difference: 0 m (0 ft.) | | BTU/h =kW x 3,412 |
| 2.Nominal heating conditions (subject to JIS B8615-2) Indoor: 20°C D.B. (68°F D.B.), Outdoor: 7°C D.B./6°C W.B. (45°F D.B./43°F W.B.) Pipe length: 7.5 m (24-9/16 ft.), Level difference: 0 m (0 ft.) | | cfm =m ³ /min x 35.31 |
| 3.Nominal heating conditions (subject to JIS B8615-2) Indoor: 20°C D.B. (68°F D.B.), Outdoor: 7°C D.B./6°C W.B. (45°F D.B./43°F W.B.) Pipe length: 7.5 m (24-9/16 ft.), Level difference: 0 m (0 ft.) Eurovent registered | | lbs =kg/0.4536 |
| 4.Cooling mode/Heating mode | | |
| 5.The sound pressure level measured by the conventional method in JIS for reference purpose. | | |
| 6.External static pressure option is available (30 Pa, 60 Pa, 80 Pa/3.1 mmH ₂ O, 6.1 mmH ₂ O, 8.2 mmH ₂ O). Consult your dealer about the specification when setting External static pressure option. | | *Above specification data is subject to rounding variation. |

1. SPECIFICATIONS

Y-Series

PUHY-P-Y(S)NW-A1

| Model | | | PUHY-P650YSNW-A1 (-BS) | | |
|--------------------------------------------------------|---------------------------------------|----------------------------------|------------------------|----------------|--|
| Power source | 3-phase 4-wire 380-400-415 V 50/60 Hz | | | | |
| Cooling capacity (Nominal) | *1 | kW | 73.0 | | |
| | | BTU/h | 249,100 | | |
| | Power input | kW | 21.79 | | |
| | Current input | A | 36.7-34.9-33.6 | | |
| | EER | kW/kW | 3.35 | | |
| | SEER | kW/kW | 6.50 | | |
| Temp. range of cooling | Indoor | W.B. | 15.0~24.0°C (59~75°F) | | |
| | Outdoor | D.B. | -5.0~52.0°C (23~126°F) | | |
| Heating capacity (Max) | *2 | kW | 81.5 | | |
| | | BTU/h | 278,100 | | |
| | Power input | kW | 20.17 | | |
| | Current input | A | 34.0-32.3-31.1 | | |
| | COP | kW/kW | 4.04 | | |
| | (Nominal) | *3 | kW | 73.0 | |
| | | | BTU/h | 249,100 | |
| | | Power input | kW | 16.97 | |
| | | Current input | A | 28.6-27.2-26.2 | |
| | | COP | kW/kW | 4.30 | |
| Temp. range of heating | Indoor | D.B. | 15.0~27.0°C (59~81°F) | | |
| | Outdoor | W.B. | -20.0~15.5°C (-4~60°F) | | |
| Indoor unit connectable | Total capacity | 50~130% of outdoor unit capacity | | | |
| | Model/Quantity | P10~P250/2-50 | | | |
| Sound pressure level (measured in anechoic room) *4, 5 | dB <A> | 66.5/68.0 | | | |
| Sound power level (measured in anechoic room) *4 | dB <A> | 83/87 | | | |
| Refrigerant piping diameter | Liquid pipe | mm (in.) | 15.88 (5/8) Brazed | | |
| | Gas pipe | mm (in.) | 28.58 (1-1/8) Brazed | | |

| Set Model | | | PUHY-P250YNW-A1 (-BS) | | PUHY-P400YNW-A1 (-BS) | |
|---------------------------------------|---------------------------------------------------------------------------------------------------------------------------------------------------------------------------------------------------------------------------------------------------------------|------------------------------------------------------------------|------------------------------------------------------------------------------------------------------|------------------------------------------------------------------|-----------------------|--|
| FAN | Type x Quantity | Propeller fan x 1 | | Propeller fan x 2 | | |
| | Air flow rate | m ³ /min | 185 | | 300 | |
| | | L/s | 3,083 | | 5,000 | |
| | | cfm | 6,532 | | 10,593 | |
| | Control, Driving mechanism | Inverter-control, Direct-driven by motor | | Inverter-control, Direct-driven by motor | | |
| | Motor output | kW | 0.92 x 1 | | 0.46 x 2 | |
| *6 External static press. | 0 Pa (0 mmH ₂ O) | | 0 Pa (0 mmH ₂ O) | | | |
| Compressor | Type | Inverter scroll hermetic compressor | | Inverter scroll hermetic compressor | | |
| | Starting method | Inverter | | Inverter | | |
| | Motor output | kW | 5.3 | | 11.4 | |
| | Case heater | kW | - | | - | |
| | Lubricant | MEL32 | | MEL32 | | |
| External finish | Pre-coated galvanized steel sheets (+powder coating for -BS type) <MUNSELL 3Y 7.8/1.1 or similar> | | Pre-coated galvanized steel sheets (+powder coating for -BS type) <MUNSELL 3Y 7.8/1.1 or similar> | | | |
| External dimension H x W x D | mm | 1,858 (1,798 without legs) x 920 x 740 | | 1,858 (1,798 without legs) x 1,240 x 740 | | |
| | in. | 73-3/16 (70-13/16 without legs) x 36-1/4 x 29-3/16 | | 73-3/16 (70-13/16 without legs) x 48-7/8 x 29-3/16 | | |
| Protection devices | High pressure protection | High pressure sensor, High pressure switch at 4.15 MPa (601 psi) | | High pressure sensor, High pressure switch at 4.15 MPa (601 psi) | | |
| | Inverter circuit (COMP./FAN) | Over-current protection | | Over-current protection | | |
| | Compressor | - | | - | | |
| | Fan motor | - | | - | | |
| Refrigerant | Type x original charge | R410A x 6.5 kg (15 lbs) | | R410A x 9.8 kg (22 lbs) | | |
| | Control | LEV and HIC circuit | | | | |
| Net weight | kg (lbs) | 213 (470) | | 277 (611) | | |
| Heat exchanger | Salt-resistant cross fin & copper tube | | Salt-resistant cross fin & copper tube | | | |
| HIC circuit (HIC: Heat Inter-Changer) | Copper pipe, tube-in-tube structure | | Copper pipe, tube-in-tube structure | | | |
| Pipe between unit and distributor | Liquid pipe | mm (in.) | 9.52 (3/8) Brazed | | 12.7 (1/2) Brazed | |
| | Gas pipe | mm (in.) | 22.2 (7/8) Brazed | | 28.58 (1-1/8) Brazed | |
| Defrosting method | Auto-defrost mode (Reversed refrigerant cycle, Hot gas) | | | | | |
| Drawing | External | KB94C1WZ | | | | |
| | Wiring | KE94L023 | | KE94L024 | | |
| Standard attachment | Document | Installation Manual | | | | |
| | Accessory | - | | | | |
| Optional parts | Outdoor Twinning kit: CMY-Y100VBK3 Joint: CMY-Y102SS/LS-G2, CMY-Y202S/302S-G2 Header: CMY-Y104/108/1010-G | | | | | |
| Remarks | Details on foundation work, duct work, insulation work, electrical wiring, power source switch, and other items shall be referred to the Installation Manual. Due to continuing improvement, above specifications may be subject to change without notice. | | | | | |

| Notes: | Unit converter |
|--------------------------------------------------------------------------------------------------------------------------------------------------------------------------------------------------------------------------------------------|-------------------------------------------------------------|
| 1. Nominal cooling conditions (subject to JIS B8615-2) Indoor: 27°C D.B./19°C W.B. (81°F D.B./66°F W.B.), Outdoor: 35°C D.B. (95°F D.B.) Pipe length: 7.5 m (24-9/16 ft.), Level difference: 0 m (0 ft.) | BTU/h =kW x 3,412 |
| 2. Nominal heating conditions (subject to JIS B8615-2) Indoor: 20°C D.B. (68°F D.B.), Outdoor: 7°C D.B./6°C W.B. (45°F D.B./43°F W.B.) Pipe length: 7.5 m (24-9/16 ft.), Level difference: 0 m (0 ft.) | cfm =m ³ /min x 35.31 |
| 3. Nominal heating conditions (subject to JIS B8615-2) Indoor: 20°C D.B. (68°F D.B.), Outdoor: 7°C D.B./6°C W.B. (45°F D.B./43°F W.B.) Pipe length: 7.5 m (24-9/16 ft.), Level difference: 0 m (0 ft.) Eurovent registered | lbs =kg/0.4536 |
| 4. Cooling mode/Heating mode | |
| 5. The sound pressure level measured by the conventional method in JIS for reference purpose. | |
| 6. External static pressure option is available (30 Pa, 60 Pa, 80 Pa/3.1 mmH ₂ O, 6.1 mmH ₂ O, 8.2 mmH ₂ O). Consult your dealer about the specification when setting External static pressure option. | *Above specification data is subject to rounding variation. |

1. SPECIFICATIONS

| Model | | | PUHY-P700YSNW-A1 (-BS) | | | |
|--------------------------------------------------------|------|----------------------------------|---------------------------------------|-----------------|----------------|--|
| Power source | | | 3-phase 4-wire 380-400-415 V 50/60 Hz | | | |
| Cooling capacity (Nominal) | | *1 kW | 80.0 | | | |
| | | BTU/h | 273,000 | | | |
| | | Power input kW | 22.59 | | | |
| | | Current input A | 38.1-36.2-34.9 | | | |
| | | EER | 3.54 | | | |
| Temp. range of cooling | | SEER | 6.63 | | | |
| | | Indoor W.B. | 15.0-24.0°C (59-75°F) | | | |
| Outdoor | | D.B. | -5.0-52.0°C (23-126°F) | | | |
| | | Heating capacity (Max) | | | *2 kW | |
| (Nominal) | | BTU/h | 88.0 | | | |
| | | Power input kW | 300,300 | | | |
| | | Current input A | 20.95 | | | |
| | | COP | 35.3-33.5-32.3 | | | |
| | | *3 kW | | kW/kW | 4.20 | |
| | | | | BTU/h | 80.0 | |
| | | | | Power input kW | 273,000 | |
| | | | | Current input A | 17.85 | |
| | | | | COP | 30.1-28.6-27.5 | |
| | | Temp. range of heating | | SCOP | 4.48 | |
| D.B. | 4.10 | | | | | |
| Indoor unit connectable | | Indoor | 15.0-27.0°C (59-81°F) | | | |
| | | Outdoor | -20.0-15.5°C (-4-60°F) | | | |
| Total capacity | | 50-130% of outdoor unit capacity | | | | |
| | | Model/Quantity | P10-P250/2-50 | | | |
| Sound pressure level (measured in anechoic room) *4, 5 | | dB <A> | 65.0/67.0 | | | |
| Sound power level (measured in anechoic room) *4 | | dB <A> | 83/86 | | | |
| Refrigerant piping diameter | | Liquid pipe | mm (in.) | | | |
| | | Gas pipe | 19.05 (3/4) Brazed | | | |
| | | | 34.93 (1-3/8) Brazed | | | |

| Set Model | | | PUHY-P350YNW-A1 (-BS) | | PUHY-P350YNW-A1 (-BS) | |
|---------------------------------------|------------------------------|-----------------------------|---------------------------------------------------------------------------------------------------------------------------------------------------------------------------------------------------------------------------------------------------------------|-----------------------------|------------------------------------------------------------------------------------------------------|----------|
| FAN | Type x Quantity | | Propeller fan x 2 | | Propeller fan x 2 | |
| | Air flow rate | m ³ /min | 270 | | 270 | |
| | | L/s | 4,500 | | 4,500 | |
| | | cfm | 9,534 | | 9,534 | |
| | Control, Driving mechanism | | Inverter-control, Direct-driven by motor | | Inverter-control, Direct-driven by motor | |
| | Motor output | kW | | 0.46 x 2 | | 0.46 x 2 |
| External static press. | | 0 Pa (0 mmH ₂ O) | | 0 Pa (0 mmH ₂ O) | | |
| | | | | | | |
| Compressor | Type | | Inverter scroll hermetic compressor | | Inverter scroll hermetic compressor | |
| | Starting method | | Inverter | | Inverter | |
| | Motor output | kW | 8.6 | | 8.6 | |
| | Case heater | kW | - | | - | |
| | Lubricant | | MEL32 | | MEL32 | |
| External finish | | | Pre-coated galvanized steel sheets (+powder coating for -BS type) <MUNSELL 3Y 7.8/1.1 or similar> | | Pre-coated galvanized steel sheets (+powder coating for -BS type) <MUNSELL 3Y 7.8/1.1 or similar> | |
| External dimension H x W x D | | | mm | | mm | |
| | | | 1,858 (1,798 without legs) x 1,240 x 740 | | 1,858 (1,798 without legs) x 1,240 x 740 | |
| | | | in. | | in. | |
| | | | 73-3/16 (70-13/16 without legs) x 48-7/8 x 29-3/16 | | 73-3/16 (70-13/16 without legs) x 48-7/8 x 29-3/16 | |
| Protection devices | High pressure protection | | High pressure sensor, High pressure switch at 4.15 MPa (601 psi) | | High pressure sensor, High pressure switch at 4.15 MPa (601 psi) | |
| | Inverter circuit (COMP./FAN) | | Over-current protection | | Over-current protection | |
| | Compressor | | - | | - | |
| | Fan motor | | - | | - | |
| Refrigerant | Type x original charge | | R410A x 9.8 kg (22 lbs) | | R410A x 9.8 kg (22 lbs) | |
| | Control | | LEV and HIC circuit | | | |
| Net weight | | kg (lbs) | 277 (611) | | 277 (611) | |
| Heat exchanger | | | Salt-resistant cross fin & copper tube | | Salt-resistant cross fin & copper tube | |
| HIC circuit (HIC: Heat Inter-Changer) | | | Copper pipe, tube-in-tube structure | | Copper pipe, tube-in-tube structure | |
| Pipe between unit and distributor | Liquid pipe | mm (in.) | 12.7 (1/2) Brazed | | 12.7 (1/2) Brazed + Flare | |
| | Gas pipe | mm (in.) | 28.58 (1-1/8) Brazed | | 28.58 (1-1/8) Brazed | |
| Defrosting method | | | Auto-defrost mode (Reversed refrigerant cycle, Hot gas) | | | |
| Drawing | External | | KB94C1X0 | | | |
| | Wiring | | KE94L024 | | KE94L024 | |
| Standard attachment | Document | | Installation Manual | | | |
| | Accessory | | - | | | |
| Optional parts | | | Outdoor Twinning kit: CMY-Y200VBK2 Joint: CMY-Y102SS/LS-G2, CMY-Y202S/302S-G2 Header: CMY-Y104/108/1010-G | | | |
| Remarks | | | Details on foundation work, duct work, insulation work, electrical wiring, power source switch, and other items shall be referred to the Installation Manual. Due to continuing improvement, above specifications may be subject to change without notice. | | | |

| Notes: | | Unit converter |
|-------------------------------------------------------------------------------------------------------------------------------------------------------------------------------------------------------------------------------------------|--|-------------------------------------------------------------|
| 1.Nominal cooling conditions (subject to JIS B8615-2) Indoor: 27°C D.B./19°C W.B. (81°F D.B./66°F W.B.), Outdoor: 35°C D.B. (95°F D.B.) Pipe length: 7.5 m (24-9/16 ft.), Level difference: 0 m (0 ft.) | | BTU/h =kW x 3,412 |
| 2.Nominal heating conditions (subject to JIS B8615-2) Indoor: 20°C D.B. (68°F D.B.), Outdoor: 7°C D.B./6°C W.B. (45°F D.B./43°F W.B.) Pipe length: 7.5 m (24-9/16 ft.), Level difference: 0 m (0 ft.) | | cfm =m ³ /min x 35.31 |
| 3.Nominal heating conditions (subject to JIS B8615-2) Indoor: 20°C D.B. (68°F D.B.), Outdoor: 7°C D.B./6°C W.B. (45°F D.B./43°F W.B.) Pipe length: 7.5 m (24-9/16 ft.), Level difference: 0 m (0 ft.) Eurovent registered | | lbs =kg/0.4536 |
| 4.Cooling mode/Heating mode | | |
| 5.The sound pressure level measured by the conventional method in JIS for reference purpose. | | |
| 6.External static pressure option is available (30 Pa, 60 Pa, 80 Pa/3.1 mmH ₂ O, 6.1 mmH ₂ O, 8.2 mmH ₂ O). Consult your dealer about the specification when setting External static pressure option. | | *Above specification data is subject to rounding variation. |

1. SPECIFICATIONS

Y-Series

PUHY-P-Y(S)NW-A1

| Model | | | PUHY-P750YSNW-A1 (-BS) | | |
|--------------------------------------------------------|----------------|----------------------------------|---------------------------------------|----------------|--|
| Power source | | | 3-phase 4-wire 380-400-415 V 50/60 Hz | | |
| Cooling capacity (Nominal) | *1 | kW | 85.0 | | |
| | | BTU/h | 290,000 | | |
| | Power input | kW | 25.83 | | |
| | Current input | A | 43.6-41.4-39.9 | | |
| | EER | kW/kW | 3.29 | | |
| | SEER | kW/kW | 6.46 | | |
| Temp. range of cooling | Indoor | W.B. | 15.0~24.0°C (59~75°F) | | |
| | Outdoor | D.B. | -5.0~52.0°C (23~126°F) | | |
| Heating capacity (Max) | *2 | kW | 95.0 | | |
| | | BTU/h | 324,100 | | |
| | Power input | kW | 23.45 | | |
| | Current input | A | 39.5-37.6-36.2 | | |
| | COP | kW/kW | 4.05 | | |
| | (Nominal) | *3 | kW | 85.0 | |
| | | | BTU/h | 290,000 | |
| | | Power input | kW | 19.72 | |
| | | Current input | A | 33.2-31.6-30.4 | |
| | | COP | kW/kW | 4.31 | |
| SCOP | | kW/kW | 4.05 | | |
| Temp. range of heating | Indoor | D.B. | 15.0~27.0°C (59~81°F) | | |
| | Outdoor | W.B. | -20.0~15.5°C (-4~60°F) | | |
| Indoor unit connectable | Total capacity | 50~130% of outdoor unit capacity | | | |
| | Model/Quantity | P10~P250/2-50 | | | |
| Sound pressure level (measured in anechoic room) *4, 5 | dB <A> | 67.0/68.5 | | | |
| Sound power level (measured in anechoic room) *4 | dB <A> | 84/88 | | | |
| Refrigerant piping diameter | Liquid pipe | mm (in.) | 19.05 (3/4) Brazed | | |
| | Gas pipe | mm (in.) | 34.93 (1-3/8) Brazed | | |

| Set Model | | | PUHY-P350YNW-A1 (-BS) | | PUHY-P400YNW-A1 (-BS) | |
|---------------------------------------|------------------------------|---------------------|---------------------------------------------------------------------------------------------------------------------------------------------------------------------------------------------------------------------------------------------------------------|-----------|------------------------------------------------------------------------------------------------------|-------|
| FAN | Type x Quantity | | Propeller fan x 2 | | Propeller fan x 2 | |
| | Air flow rate | m ³ /min | 270 | | 300 | |
| | | L/s | 4,500 | | 5,000 | |
| | | cfm | 9,534 | | 10,593 | |
| | Control, Driving mechanism | | Inverter-control, Direct-driven by motor | | Inverter-control, Direct-driven by motor | |
| | Motor output | kW | 0.46 x 2 | | 0.46 x 2 | |
| *6 | External static press. | | 0 Pa (0 mmH ₂ O) | | 0 Pa (0 mmH ₂ O) | |
| Compressor | Type | | Inverter scroll hermetic compressor | | Inverter scroll hermetic compressor | |
| | Starting method | | Inverter | | Inverter | |
| | Motor output | kW | 8.6 | | 11.4 | |
| | Case heater | kW | - | | - | |
| | Lubricant | | | MEL32 | | MEL32 |
| External finish | | | Pre-coated galvanized steel sheets (+powder coating for -BS type) <MUNSELL 3Y 7.8/1.1 or similar> | | Pre-coated galvanized steel sheets (+powder coating for -BS type) <MUNSELL 3Y 7.8/1.1 or similar> | |
| External dimension H x W x D | | | mm 1,858 (1,798 without legs) x 1,240 x 740 | | mm 1,858 (1,798 without legs) x 1,240 x 740 | |
| | | | in. 73-3/16 (70-13/16 without legs) x 48-7/8 x 29-3/16 | | in. 73-3/16 (70-13/16 without legs) x 48-7/8 x 29-3/16 | |
| Protection devices | High pressure protection | | High pressure sensor, High pressure switch at 4.15 MPa (601 psi) | | High pressure sensor, High pressure switch at 4.15 MPa (601 psi) | |
| | Inverter circuit (COMP./FAN) | | Over-current protection | | Over-current protection | |
| | Compressor | | - | | - | |
| | Fan motor | | - | | - | |
| Refrigerant | Type x original charge | | R410A x 9.8 kg (22 lbs) | | R410A x 9.8 kg (22 lbs) | |
| | Control | | LEV and HIC circuit | | | |
| Net weight | kg (lbs) | 277 (611) | | 277 (611) | | |
| Heat exchanger | | | Salt-resistant cross fin & copper tube | | Salt-resistant cross fin & copper tube | |
| HIC circuit (HIC: Heat Inter-Changer) | | | Copper pipe, tube-in-tube structure | | Copper pipe, tube-in-tube structure | |
| Pipe between unit and distributor | Liquid pipe | mm (in.) | 12.7 (1/2) Brazed | | 15.88 (5/8) Brazed | |
| | Gas pipe | mm (in.) | 28.58 (1-1/8) Brazed | | 28.58 (1-1/8) Brazed | |
| Defrosting method | | | Auto-defrost mode (Reversed refrigerant cycle, Hot gas) | | | |
| Drawing | External | | KB94C1X0 | | | |
| | Wiring | | KE94L024 | | KE94L024 | |
| Standard attachment | Document | | Installation Manual | | | |
| | Accessory | | - | | | |
| Optional parts | | | Outdoor Twinning kit: CMY-Y200VBK2 Joint: CMY-Y102SS/LS-G2, CMY-Y202S/302S-G2 Header: CMY-Y104/108/1010-G | | | |
| Remarks | | | Details on foundation work, duct work, insulation work, electrical wiring, power source switch, and other items shall be referred to the Installation Manual. Due to continuing improvement, above specifications may be subject to change without notice. | | | |

| Notes: | Unit converter |
|--------------------------------------------------------------------------------------------------------------------------------------------------------------------------------------------------------------------------------------------|-------------------------------------------------------------|
| 1. Nominal cooling conditions (subject to JIS B8615-2) Indoor: 27°C D.B./19°C W.B. (81°F D.B./66°F W.B.), Outdoor: 35°C D.B. (95°F D.B.) Pipe length: 7.5 m (24-9/16 ft.), Level difference: 0 m (0 ft.) | BTU/h =kW x 3,412 |
| 2. Nominal heating conditions (subject to JIS B8615-2) Indoor: 20°C D.B. (68°F D.B.), Outdoor: 7°C D.B./6°C W.B. (45°F D.B./43°F W.B.) Pipe length: 7.5 m (24-9/16 ft.), Level difference: 0 m (0 ft.) | cfm =m ³ /min x 35.31 |
| 3. Nominal heating conditions (subject to JIS B8615-2) Indoor: 20°C D.B. (68°F D.B.), Outdoor: 7°C D.B./6°C W.B. (45°F D.B./43°F W.B.) Pipe length: 7.5 m (24-9/16 ft.), Level difference: 0 m (0 ft.) Eurovent registered | lbs =kg/0.4536 |
| 4. Cooling mode/Heating mode | |
| 5. The sound pressure level measured by the conventional method in JIS for reference purpose. | |
| 6. External static pressure option is available (30 Pa, 60 Pa, 80 Pa/3.1 mmH ₂ O, 6.1 mmH ₂ O, 8.2 mmH ₂ O). Consult your dealer about the specification when setting External static pressure option. | *Above specification data is subject to rounding variation. |

1. SPECIFICATIONS

| Model | | | PUHY-P800YSNW-A1 (-BS) | | |
|--------------------------------------------------------|----------------|----------------------------------|---------------------------------------|----------------|--|
| Power source | | | 3-phase 4-wire 380-400-415 V 50/60 Hz | | |
| Cooling capacity (Nominal) | | *1 kW | 90.0 | | |
| | | BTU/h | 307,100 | | |
| | | Power input kW | 26.31 | | |
| | | Current input A | 44.4-42.1-40.6 | | |
| | | EER | kW/kW 3.42 | | |
| Temp. range of cooling | Indoor | W.B. | 15.0~24.0°C (59~75°F) | | |
| | | D.B. | -5.0~52.0°C (23~126°F) | | |
| | | Outdoor | | | |
| Heating capacity (Max) | | *2 kW | 100.0 | | |
| | | BTU/h | 341,200 | | |
| | | Power input kW | 24.87 | | |
| | | Current input A | 41.9-39.8-38.4 | | |
| | | COP | kW/kW 4.02 | | |
| | (Nominal) | | *3 kW | 90.0 | |
| | | | BTU/h | 307,100 | |
| | | | Power input kW | 20.97 | |
| | | | Current input A | 35.4-33.6-32.4 | |
| | | | COP | kW/kW 4.29 | |
| Temp. range of heating | Indoor | D.B. | 15.0~27.0°C (59~81°F) | | |
| | | W.B. | -20.0~15.5°C (-4~60°F) | | |
| Indoor unit connectable | Total capacity | 50~130% of outdoor unit capacity | | | |
| | Model/Quantity | P10-P250/2~50 | | | |
| Sound pressure level (measured in anechoic room) *4, 5 | | dB <A> | 67.5/71.0 | | |
| Sound power level (measured in anechoic room) *4 | | dB <A> | 85/90 | | |
| Refrigerant piping diameter | Liquid pipe | mm (in.) | 19.05 (3/4) Brazed | | |
| | Gas pipe | mm (in.) | 34.93 (1-3/8) Brazed | | |

| Set Model | | | PUHY-P350YNW-A1 (-BS) | | PUHY-P450YNW-A1 (-BS) | |
|---------------------------------------|------------------------------|-------------------------------------|---------------------------------------------------------------------------------------------------------------------------------------------------------------------------------------------------------------------------------------------------------------|-------------------------------------|------------------------------------------------------------------------------------------------------|----------|
| FAN | Type x Quantity | | Propeller fan x 2 | | Propeller fan x 2 | |
| | Air flow rate | m ³ /min | 270 | | 305 | |
| | | L/s | 4,500 | | 5,083 | |
| | | cfm | 9,534 | | 10,770 | |
| | Control, Driving mechanism | | Inverter-control, Direct-driven by motor | | Inverter-control, Direct-driven by motor | |
| | Motor output | kW | | 0.46 x 2 | | 0.46 x 2 |
| External static press. | | 0 Pa (0 mmH ₂ O) | | 0 Pa (0 mmH ₂ O) | | |
| Type | | Inverter scroll hermetic compressor | | Inverter scroll hermetic compressor | | |
| Compressor | Starting method | | Inverter | | Inverter | |
| | Motor output | kW | 8.6 | | 11.7 | |
| | Case heater | kW | - | | - | |
| | Lubricant | MEL32 | | MEL32 | | |
| External finish | | | Pre-coated galvanized steel sheets (+powder coating for -BS type) <MUNSELL 3Y 7.8/1.1 or similar> | | Pre-coated galvanized steel sheets (+powder coating for -BS type) <MUNSELL 3Y 7.8/1.1 or similar> | |
| External dimension H x W x D | | | mm 1,858 (1,798 without legs) x 1,240 x 740 | | mm 1,858 (1,798 without legs) x 1,240 x 740 | |
| | | | in. 73-3/16 (70-13/16 without legs) x 48-7/8 x 29-3/16 | | in. 73-3/16 (70-13/16 without legs) x 48-7/8 x 29-3/16 | |
| Protection devices | High pressure protection | | High pressure sensor, High pressure switch at 4.15 MPa (601 psi) | | High pressure sensor, High pressure switch at 4.15 MPa (601 psi) | |
| | Inverter circuit (COMP./FAN) | | Over-current protection | | Over-current protection | |
| | Compressor | | - | | - | |
| | Fan motor | | - | | - | |
| Refrigerant | Type x original charge | | R410A x 9.8 kg (22 lbs) | | R410A x 10.8 kg (24 lbs) | |
| | Control | | LEV and HIC circuit | | | |
| Net weight | | | kg (lbs) 277 (611) | | kg (lbs) 293 (646) | |
| Heat exchanger | | | Salt-resistant cross fin & copper tube | | Salt-resistant cross fin & copper tube | |
| HIC circuit (HIC: Heat Inter-Changer) | | | Copper pipe, tube-in-tube structure | | Copper pipe, tube-in-tube structure | |
| Pipe between unit and distributor | Liquid pipe | mm (in.) | 12.7 (1/2) Brazed | | 15.88 (5/8) Brazed | |
| | Gas pipe | mm (in.) | 28.58 (1-1/8) Brazed | | 28.58 (1-1/8) Brazed | |
| Defrosting method | | | Auto-defrost mode (Reversed refrigerant cycle, Hot gas) | | | |
| Drawing | External | | KB94C1X0 | | | |
| | Wiring | | KE94L024 | | KE94L024 | |
| Standard attachment | Document | | Installation Manual | | | |
| | Accessory | | - | | | |
| Optional parts | | | Outdoor Twinning kit: CMY-Y200VBK2 Joint: CMY-Y102SS/LS-G2, CMY-Y202S/302S-G2 Header: CMY-Y104/108/1010-G | | | |
| Remarks | | | Details on foundation work, duct work, insulation work, electrical wiring, power source switch, and other items shall be referred to the Installation Manual. Due to continuing improvement, above specifications may be subject to change without notice. | | | |

| Notes: | | Unit converter |
|-------------------------------------------------------------------------------------------------------------------------------------------------------------------------------------------------------------------------------------------|--|-------------------------------------------------------------|
| 1.Nominal cooling conditions (subject to JIS B8615-2) Indoor: 27°C D.B./19°C W.B. (81°F D.B./66°F W.B.), Outdoor: 35°C D.B. (95°F D.B.) Pipe length: 7.5 m (24-9/16 ft.), Level difference: 0 m (0 ft.) | | BTU/h =kW x 3,412 |
| 2.Nominal heating conditions (subject to JIS B8615-2) Indoor: 20°C D.B. (68°F D.B.), Outdoor: 7°C D.B./6°C W.B. (45°F D.B./43°F W.B.) Pipe length: 7.5 m (24-9/16 ft.), Level difference: 0 m (0 ft.) | | cfm =m ³ /min x 35.31 |
| 3.Nominal heating conditions (subject to JIS B8615-2) Indoor: 20°C D.B. (68°F D.B.), Outdoor: 7°C D.B./6°C W.B. (45°F D.B./43°F W.B.) Pipe length: 7.5 m (24-9/16 ft.), Level difference: 0 m (0 ft.) Eurovent registered | | lbs =kg/0.4536 |
| 4.Cooling mode/Heating mode | | |
| 5.The sound pressure level measured by the conventional method in JIS for reference purpose. | | |
| 6.External static pressure option is available (30 Pa, 60 Pa, 80 Pa/3.1 mmH ₂ O, 6.1 mmH ₂ O, 8.2 mmH ₂ O). Consult your dealer about the specification when setting External static pressure option. | | |
| | | *Above specification data is subject to rounding variation. |

1. SPECIFICATIONS

Y-Series

PUHY-P-Y(S)NW-A1

| Model | | | PUHY-P850YSNW-A1 (-BS) | | |
|--------------------------------------------------------|---------------------------------------|----------------------------------|------------------------|----------------|--|
| Power source | 3-phase 4-wire 380-400-415 V 50/60 Hz | | | | |
| Cooling capacity (Nominal) | *1 | kW | 96.0 | | |
| | | BTU/h | 327,600 | | |
| | Power input | kW | 30.00 | | |
| | Current input | A | 50.6-48.1-46.3 | | |
| | EER | kW/kW | 3.20 | | |
| | SEER | kW/kW | 6.38 | | |
| Temp. range of cooling | Indoor | W.B. | 15.0~24.0°C (59~75°F) | | |
| | Outdoor | D.B. | -5.0~52.0°C (23~126°F) | | |
| Heating capacity (Max) | *2 | kW | 108.0 | | |
| | | BTU/h | 368,500 | | |
| | Power input | kW | 27.76 | | |
| | Current input | A | 46.8-44.5-42.9 | | |
| | COP | kW/kW | 3.89 | | |
| | (Nominal) | *3 | kW | 96.0 | |
| | | | BTU/h | 327,600 | |
| | | Power input | kW | 23.07 | |
| | | Current input | A | 38.9-36.9-35.6 | |
| | | | COP | 4.16 | |
| | | SCOP | 3.86 | | |
| Indoor | | D.B. | 15.0~27.0°C (59~81°F) | | |
| Outdoor | | W.B. | -20.0~15.5°C (-4~60°F) | | |
| Indoor unit connectable | Total capacity | 50~130% of outdoor unit capacity | | | |
| | Model/Quantity | P10~P250/2-50 | | | |
| Sound pressure level (measured in anechoic room) *4, 5 | dB <A> | 68.5/71.5 | | | |
| Sound power level (measured in anechoic room) *4 | dB <A> | 86/91 | | | |
| Refrigerant piping diameter | Liquid pipe | mm (in.) | 19.05 (3/4) Brazed | | |
| | Gas pipe | mm (in.) | 41.28 (1-5/8) Brazed | | |

| Set Model | | | PUHY-P400YNW-A1 (-BS) | | PUHY-P450YNW-A1 (-BS) | |
|---------------------------------------|---------------------------------------------------------------------------------------------------------------------------------------------------------------------------------------------------------------------------------------------------------------|------------------------------------------------------------------|------------------------------------------------------------------------------------------------------|------------------------------------------------------------------|-----------------------|--|
| FAN | Type x Quantity | Propeller fan x 2 | | Propeller fan x 2 | | |
| | Air flow rate | m ³ /min | 300 | | 305 | |
| | | L/s | 5,000 | | 5,083 | |
| | | cfm | 10,593 | | 10,770 | |
| | Control, Driving mechanism | Inverter-control, Direct-driven by motor | | Inverter-control, Direct-driven by motor | | |
| | Motor output | kW | 0.46 x 2 | | 0.46 x 2 | |
| *6 External static press. | 0 Pa (0 mmH ₂ O) | | 0 Pa (0 mmH ₂ O) | | | |
| Compressor | Type | Inverter scroll hermetic compressor | | Inverter scroll hermetic compressor | | |
| | Starting method | Inverter | | Inverter | | |
| | Motor output | kW | 11.4 | | 11.7 | |
| | Case heater | kW | - | | - | |
| | Lubricant | MEL32 | | MEL32 | | |
| External finish | Pre-coated galvanized steel sheets (+powder coating for -BS type) <MUNSELL 3Y 7.8/1.1 or similar> | | Pre-coated galvanized steel sheets (+powder coating for -BS type) <MUNSELL 3Y 7.8/1.1 or similar> | | | |
| External dimension H x W x D | mm | 1,858 (1,798 without legs) x 1,240 x 740 | | 1,858 (1,798 without legs) x 1,240 x 740 | | |
| | in. | 73-3/16 (70-13/16 without legs) x 48-7/8 x 29-3/16 | | 73-3/16 (70-13/16 without legs) x 48-7/8 x 29-3/16 | | |
| Protection devices | High pressure protection | High pressure sensor, High pressure switch at 4.15 MPa (601 psi) | | High pressure sensor, High pressure switch at 4.15 MPa (601 psi) | | |
| | Inverter circuit (COMP./FAN) | Over-current protection | | Over-current protection | | |
| | Compressor | - | | - | | |
| | Fan motor | - | | - | | |
| Refrigerant | Type x original charge | R410A x 9.8 kg (22 lbs) | | R410A x 10.8 kg (24 lbs) | | |
| | Control | LEV and HIC circuit | | | | |
| Net weight | kg (lbs) | 277 (611) | | 293 (646) | | |
| Heat exchanger | Salt-resistant cross fin & copper tube | | Salt-resistant cross fin & copper tube | | | |
| HIC circuit (HIC: Heat Inter-Changer) | Copper pipe, tube-in-tube structure | | Copper pipe, tube-in-tube structure | | | |
| Pipe between unit and distributor | Liquid pipe | mm (in.) | 15.88 (5/8) Brazed | | 15.88 (5/8) Brazed | |
| | Gas pipe | mm (in.) | 28.58 (1-1/8) Brazed | | 28.58 (1-1/8) Brazed | |
| Defrosting method | Auto-defrost mode (Reversed refrigerant cycle, Hot gas) | | | | | |
| Drawing | External | KB94C1X0 | | | | |
| | Wiring | KE94L024 | | KE94L024 | | |
| Standard attachment | Document | Installation Manual | | | | |
| | Accessory | - | | | | |
| Optional parts | Outdoor Twinning kit: CMY-Y200VBK2 Joint: CMY-Y102SS/LS-G2, CMY-Y202S/302S-G2 Header: CMY-104/108/1010-G | | | | | |
| Remarks | Details on foundation work, duct work, insulation work, electrical wiring, power source switch, and other items shall be referred to the Installation Manual. Due to continuing improvement, above specifications may be subject to change without notice. | | | | | |

| Notes: | Unit converter |
|--------------------------------------------------------------------------------------------------------------------------------------------------------------------------------------------------------------------------------------------|-------------------------------------------------------------|
| 1. Nominal cooling conditions (subject to JIS B8615-2) Indoor: 27°C D.B./19°C W.B. (81°F D.B./66°F W.B.), Outdoor: 35°C D.B. (95°F D.B.) Pipe length: 7.5 m (24-9/16 ft.), Level difference: 0 m (0 ft.) | BTU/h =kW x 3,412 |
| 2. Nominal heating conditions (subject to JIS B8615-2) Indoor: 20°C D.B. (68°F D.B.), Outdoor: 7°C D.B./6°C W.B. (45°F D.B./43°F W.B.) Pipe length: 7.5 m (24-9/16 ft.), Level difference: 0 m (0 ft.) | cfm =m ³ /min x 35.31 |
| 3. Nominal heating conditions (subject to JIS B8615-2) Indoor: 20°C D.B. (68°F D.B.), Outdoor: 7°C D.B./6°C W.B. (45°F D.B./43°F W.B.) Pipe length: 7.5 m (24-9/16 ft.), Level difference: 0 m (0 ft.) Eurovent registered | lbs =kg/0.4536 |
| 4. Cooling mode/Heating mode | |
| 5. The sound pressure level measured by the conventional method in JIS for reference purpose. | |
| 6. External static pressure option is available (30 Pa, 60 Pa, 80 Pa/3.1 mmH ₂ O, 6.1 mmH ₂ O, 8.2 mmH ₂ O). Consult your dealer about the specification when setting External static pressure option. | *Above specification data is subject to rounding variation. |

1. SPECIFICATIONS

| Model | | | PUHY-P900YSNW-A1 (-BS) | | |
|--------------------------------------------------------|----------------|----------------------------------|---------------------------------------|----------------|--|
| Power source | | | 3-phase 4-wire 380-400-415 V 50/60 Hz | | |
| Cooling capacity (Nominal) | *1 | kW | 101.0 | | |
| | | BTU/h | 344,600 | | |
| | | Power input kW | 30.42 | | |
| | | Current input A | 51.3-48.7-47.0 | | |
| | | EER | 3.32 | | |
| | | SEER | 6.41 | | |
| Temp. range of cooling | Indoor | W.B. | 15.0~24.0°C (59~75°F) | | |
| | Outdoor | D.B. | -5.0~52.0°C (23~126°F) | | |
| Heating capacity (Max) | *2 | kW | 113.0 | | |
| | | BTU/h | 385,600 | | |
| | | Power input kW | 29.12 | | |
| | | Current input A | 49.1-46.7-45.0 | | |
| | | COP | 3.88 | | |
| | (Nominal) | *3 | kW | 101.0 | |
| | | | BTU/h | 344,600 | |
| | | | Power input kW | 24.33 | |
| | | | Current input A | 41.0-39.0-37.6 | |
| | | | COP | 4.15 | |
| | | SCOP | 3.71 | | |
| Temp. range of heating | Indoor | D.B. | 15.0~27.0°C (59~81°F) | | |
| | Outdoor | W.B. | -20.0~15.5°C (-4~60°F) | | |
| Indoor unit connectable | Total capacity | 50~130% of outdoor unit capacity | | | |
| | Model/Quantity | P10-P250/2~50 | | | |
| Sound pressure level (measured in anechoic room) *4, 5 | | dB <A> | 68.5/72.5 | | |
| Sound power level (measured in anechoic room) *4 | | dB <A> | 87/92 | | |
| Refrigerant piping diameter | Liquid pipe | mm (in.) | 19.05 (3/4) Brazed | | |
| | Gas pipe | mm (in.) | 41.28 (1-5/8) Brazed | | |

| Set Model | | | PUHY-P450YNW-A1 (-BS) | | PUHY-P450YNW-A1 (-BS) | |
|---------------------------------------|------------------------------|-------------------------------------|---------------------------------------------------------------------------------------------------------------------------------------------------------------------------------------------------------------------------------------------------------------|-------------------------------------|------------------------------------------------------------------------------------------------------|----------|
| FAN | Type x Quantity | | Propeller fan x 2 | | Propeller fan x 2 | |
| | Air flow rate | m ³ /min | 305 | | 305 | |
| | | L/s | 5,083 | | 5,083 | |
| | | cfm | 10,770 | | 10,770 | |
| | Control, Driving mechanism | | Inverter-control, Direct-driven by motor | | Inverter-control, Direct-driven by motor | |
| | *6 | Motor output | kW | 0.46 x 2 | | 0.46 x 2 |
| External static press. | | 0 Pa (0 mmH ₂ O) | | 0 Pa (0 mmH ₂ O) | | |
| Compressor | | Inverter scroll hermetic compressor | | Inverter scroll hermetic compressor | | |
| Compressor | Starting method | | Inverter | | Inverter | |
| | Motor output | kW | 11.7 | | 11.7 | |
| | Case heater | kW | - | | - | |
| | Lubricant | | MEL32 | | MEL32 | |
| External finish | | | Pre-coated galvanized steel sheets (+powder coating for -BS type) <MUNSELL 3Y 7.8/1.1 or similar> | | Pre-coated galvanized steel sheets (+powder coating for -BS type) <MUNSELL 3Y 7.8/1.1 or similar> | |
| External dimension H x W x D | | | mm | | 1,858 (1,798 without legs) x 1,240 x 740 | |
| | | | in. | | 73-3/16 (70-13/16 without legs) x 48-7/8 x 29-3/16 | |
| Protection devices | High pressure protection | | High pressure sensor, High pressure switch at 4.15 MPa (601 psi) | | High pressure sensor, High pressure switch at 4.15 MPa (601 psi) | |
| | Inverter circuit (COMP./FAN) | | Over-current protection | | Over-current protection | |
| | Compressor | | - | | - | |
| | Fan motor | | - | | - | |
| Refrigerant | Type x original charge | | R410A x 10.8 kg (24 lbs) | | R410A x 10.8 kg (24 lbs) | |
| | Control | | LEV and HIC circuit | | | |
| Net weight | | | kg (lbs) | | 293 (646) | |
| Heat exchanger | | | Salt-resistant cross fin & copper tube | | Salt-resistant cross fin & copper tube | |
| HIC circuit (HIC: Heat Inter-Changer) | | | Copper pipe, tube-in-tube structure | | Copper pipe, tube-in-tube structure | |
| Pipe between unit and distributor | Liquid pipe | mm (in.) | 15.88 (5/8) Brazed | | 15.88 (5/8) Brazed | |
| | Gas pipe | mm (in.) | 28.58 (1-1/8) Brazed | | 28.58 (1-1/8) Brazed | |
| Defrosting method | | | Auto-defrost mode (Reversed refrigerant cycle, Hot gas) | | | |
| Drawing | External | | KB94C1X0 | | | |
| | Wiring | | KE94L024 | | KE94L024 | |
| Standard attachment | Document | | Installation Manual | | | |
| | Accessory | | - | | | |
| Optional parts | | | Outdoor Twinning kit: CMY-Y200VBK2 Joint: CMY-Y102SS/LS-G2, CMY-Y202S/302S-G2 Header: CMY-Y104/108/1010-G | | | |
| Remarks | | | Details on foundation work, duct work, insulation work, electrical wiring, power source switch, and other items shall be referred to the Installation Manual. Due to continuing improvement, above specifications may be subject to change without notice. | | | |

| Notes: | | Unit converter |
|-------------------------------------------------------------------------------------------------------------------------------------------------------------------------------------------------------------------------------------------|--|-------------------------------------------------------------|
| 1.Nominal cooling conditions (subject to JIS B8615-2) Indoor: 27°C D.B./19°C W.B. (81°F D.B./66°F W.B.), Outdoor: 35°C D.B. (95°F D.B.) Pipe length: 7.5 m (24-9/16 ft.), Level difference: 0 m (0 ft.) | | BTU/h =kW x 3,412 |
| 2.Nominal heating conditions (subject to JIS B8615-2) Indoor: 20°C D.B. (68°F D.B.), Outdoor: 7°C D.B./6°C W.B. (45°F D.B./43°F W.B.) Pipe length: 7.5 m (24-9/16 ft.), Level difference: 0 m (0 ft.) | | cfm =m ³ /min x 35.31 |
| 3.Nominal heating conditions (subject to JIS B8615-2) Indoor: 20°C D.B. (68°F D.B.), Outdoor: 7°C D.B./6°C W.B. (45°F D.B./43°F W.B.) Pipe length: 7.5 m (24-9/16 ft.), Level difference: 0 m (0 ft.) Eurovent registered | | lbs =kg/0.4536 |
| 4.Cooling mode/Heating mode | | |
| 5.The sound pressure level measured by the conventional method in JIS for reference purpose. | | |
| 6.External static pressure option is available (30 Pa, 60 Pa, 80 Pa/3.1 mmH ₂ O, 6.1 mmH ₂ O, 8.2 mmH ₂ O). Consult your dealer about the specification when setting External static pressure option. | | *Above specification data is subject to rounding variation. |

1. SPECIFICATIONS

Y-Series

PUHY-P-Y(S)NW-A1

| Model | | | PUHY-P950YSNW-A1 (-BS) | | |
|--------------------------------------------------------|----------------|----------------------------------|---------------------------------------|----------------|--|
| Power source | | | 3-phase 4-wire 380-400-415 V 50/60 Hz | | |
| Cooling capacity (Nominal) | *1 | kW | 108.0 | | |
| | | BTU/h | 368,500 | | |
| | Power input | kW | 30.00 | | |
| | Current input | A | 50.6-48.1-46.3 | | |
| | EER | kW/kW | 3.60 | | |
| | SEER | kW/kW | 6.72 | | |
| Temp. range of cooling | Indoor | W.B. | 15.0~24.0°C (59~75°F) | | |
| | Outdoor | D.B. | -5.0~52.0°C (23~126°F) | | |
| Heating capacity (Max) | *2 | kW | 119.5 | | |
| | | BTU/h | 407,700 | | |
| | Power input | kW | 28.38 | | |
| | Current input | A | 47.9-45.5-43.8 | | |
| | COP | kW/kW | 4.21 | | |
| | (Nominal) | *3 | kW | 108.0 | |
| | | | BTU/h | 368,500 | |
| | | Power input | kW | 24.10 | |
| | | Current input | A | 40.6-38.6-37.2 | |
| | | COP | kW/kW | 4.48 | |
| SCOP | | kW/kW | 4.09 | | |
| Temp. range of heating | Indoor | D.B. | 15.0~27.0°C (59~81°F) | | |
| | Outdoor | W.B. | -20.0~15.5°C (-4~60°F) | | |
| Indoor unit connectable | Total capacity | 50~130% of outdoor unit capacity | | | |
| | Model/Quantity | P10~P250/2~50 | | | |
| Sound pressure level (measured in anechoic room) *4, 5 | dB <A> | | 66.0/68.0 | | |
| Sound power level (measured in anechoic room) *4 | dB <A> | | 84/87 | | |
| Refrigerant piping diameter | Liquid pipe | mm (in.) | 19.05 (3/4) Brazed | | |
| | Gas pipe | mm (in.) | 41.28 (1-5/8) Brazed | | |

| Set Model | | | PUHY-P250YNW-A1 (-BS) | PUHY-P350YNW-A1 (-BS) | PUHY-P350YNW-A1 (-BS) |
|---------------------------------------|------------------------------|---------------------|---------------------------------------------------------------------------------------------------------------------------------------------------------------------------------------------------------------------------------------------------------------|-------------------------------------------------------------------------------------------------------------|-------------------------------------------------------------------------------------------------------------|
| Model | | | | | |
| FAN | Type x Quantity | | Propeller fan x 1 | Propeller fan x 2 | Propeller fan x 2 |
| | Air flow rate | m ³ /min | 185 | 270 | 270 |
| | | L/s | 3,083 | 4,500 | 4,500 |
| | | cfm | 6,532 | 9,534 | 9,534 |
| | Control, Driving mechanism | | Inverter-control, Direct-driven by motor | Inverter-control, Direct-driven by motor | Inverter-control, Direct-driven by motor |
| | Motor output | kW | 0.92 x 1 | 0.46 x 2 | 0.46 x 2 |
| *6 | External static press. | | 0 Pa (0 mmH ₂ O) | 0 Pa (0 mmH ₂ O) | 0 Pa (0 mmH ₂ O) |
| Compressor | Type | | Inverter scroll hermetic compressor | Inverter scroll hermetic compressor | Inverter scroll hermetic compressor |
| | Starting method | | Inverter | Inverter | Inverter |
| | Motor output | kW | 5.3 | 8.6 | 8.6 |
| | Case heater | kW | - | - | - |
| | Lubricant | | MEL32 | MEL32 | MEL32 |
| External finish | | | Pre-coated galvanized steel sheets (+powder coating for -BS type) <MUNSELL 3Y 7.8/1.1 or similar> | Pre-coated galvanized steel sheets (+powder coating for -BS type) <MUNSELL 3Y 7.8/1.1 or similar> | Pre-coated galvanized steel sheets (+powder coating for -BS type) <MUNSELL 3Y 7.8/1.1 or similar> |
| External dimension H x W x D | | | mm 1,858 (1,798 without legs) x 920 x 740 in. 73-3/16 (70-13/16 without legs) x 36-1/4 x 29-3/16 | mm 1,858 (1,798 without legs) x 1,240 x 740 in. 73-3/16 (70-13/16 without legs) x 48-7/8 x 29-3/16 | mm 1,858 (1,798 without legs) x 1,240 x 740 in. 73-3/16 (70-13/16 without legs) x 48-7/8 x 29-3/16 |
| Protection devices | High pressure protection | | High pressure sensor, High pressure switch at 4.15 MPa (601 psi) | High pressure sensor, High pressure switch at 4.15 MPa (601 psi) | High pressure sensor, High pressure switch at 4.15 MPa (601 psi) |
| | Inverter circuit (COMP./FAN) | | Over-current protection | Over-current protection | Over-current protection |
| | Compressor | | - | - | - |
| | Fan motor | | - | - | - |
| Refrigerant | Type x original charge | | R410A x 6.5 kg (15 lbs) | R410A x 9.8 kg (22 lbs) | R410A x 9.8 kg (22 lbs) |
| | Control | | LEV and HIC circuit | | |
| Net weight | | | kg (lbs) 213 (470) | 277 (611) | 277 (611) |
| Heat exchanger | | | Salt-resistant cross fin & copper tube | Salt-resistant cross fin & copper tube | Salt-resistant cross fin & copper tube |
| HIC circuit (HIC: Heat Inter-Changer) | | | Copper pipe, tube-in-tube structure | Copper pipe, tube-in-tube structure | Copper pipe, tube-in-tube structure |
| Pipe between unit and distributor | Liquid pipe | mm (in.) | 9.52 (3/8) Brazed | 12.7 (1/2) Brazed | 12.7 (1/2) Brazed |
| | Gas pipe | mm (in.) | 22.2 (7/8) Brazed | 28.58 (1-1/8) Brazed | 28.58 (1-1/8) Brazed |
| Defrosting method | | | Auto-defrost mode (Reversed refrigerant cycle, Hot gas) | | |
| Drawing | External | | KB94C1X1 | | |
| | Wiring | | KE94L023 | KE94L024 | KE94L024 |
| Standard attachment | Document | | Installation Manual | | |
| | Accessory | | - | | |
| Optional parts | | | Outdoor Twinning kit: CMY-Y300VBK3 Joint: CMY-Y102SS/LS-G2, CMY-Y202/302S-G2 Header: CMY-Y104/108/1010-G | | |
| Remarks | | | Details on foundation work, duct work, insulation work, electrical wiring, power source switch, and other items shall be referred to the Installation Manual. Due to continuing improvement, above specifications may be subject to change without notice. | | |

| Notes: | Unit converter |
|-------------------------------------------------------------------------------------------------------------------------------------------------------------------------------------------------------------------------------------------|-------------------------------------------------------------|
| 1.Nominal cooling conditions (subject to JIS B8615-2) Indoor: 27°C D.B./19°C W.B. (81°F D.B./66°F W.B.), Outdoor: 35°C D.B. (95°F D.B.) Pipe length: 7.5 m (24-9/16 ft.), Level difference: 0 m (0 ft.) | BTU/h =kW x 3,412 |
| 2.Nominal heating conditions (subject to JIS B8615-2) Indoor: 20°C D.B. (68°F D.B.), Outdoor: 7°C D.B./6°C W.B. (45°F D.B./43°F W.B.) Pipe length: 7.5 m (24-9/16 ft.), Level difference: 0 m (0 ft.) | cfm =m ³ /min x 35.31 |
| 3.Nominal heating conditions (subject to JIS B8615-2) Indoor: 20°C D.B. (68°F D.B.), Outdoor: 7°C D.B./6°C W.B. (45°F D.B./43°F W.B.) Pipe length: 7.5 m (24-9/16 ft.), Level difference: 0 m (0 ft.) Eurovent registered | lbs =kg/0.4536 |
| 4.Cooling mode/Heating mode | |
| 5.The sound pressure level measured by the conventional method in JIS for reference purpose. | |
| 6.External static pressure option is available (30 Pa, 60 Pa, 80 Pa/3.1 mmH ₂ O, 6.1 mmH ₂ O, 8.2 mmH ₂ O). Consult your dealer about the specification when setting External static pressure option. | *Above specification data is subject to rounding variation. |

1. SPECIFICATIONS

Y-Series

PUHY-P-Y(S)NW-A1

| | | | | | | |
|--------------------------------------------------------|----------------|-----------------|---------------------------------------|---------|--|--|
| Model | | | PUHY-P1000YSNW-A1 (-BS) | | | |
| Power source | | | 3-phase 4-wire 380-400-415 V 50/60 Hz | | | |
| Cooling capacity (Nominal) | | *1 kW | 113.0 | | | |
| | | BTU/h | 385,600 | | | |
| | | Power input kW | 33.13 | | | |
| | | Current input A | 55.9-53.1-51.2 | | | |
| | | EER | 3.41 | | | |
| | | SEER | 6.59 | | | |
| Temp. range of cooling | Indoor | W.B. | 15.0-24.0°C (59-75°F) | | | |
| | Outdoor | D.B. | -5.0-52.0°C (23-126°F) | | | |
| Heating capacity (Max) | | *2 kW | 127.0 | | | |
| | | BTU/h | 433,300 | | | |
| | | Power input kW | 31.05 | | | |
| | | Current input A | 52.4-49.7-47.9 | | | |
| | | COP | 4.09 | | | |
| | | (Nominal) | *3 kW | 113.0 | | |
| | | | BTU/h | 385,600 | | |
| | | | Power input kW | 25.91 | | |
| Current input A | 43.7-41.5-40.0 | | | | | |
| | | COP | 4.36 | | | |
| | | SCOP | 4.06 | | | |
| Temp. range of heating | Indoor | D.B. | 15.0-27.0°C (59-81°F) | | | |
| | Outdoor | W.B. | -20.0-15.5°C (-4-60°F) | | | |
| Indoor unit connectable | Total capacity | | 50-130% of outdoor unit capacity | | | |
| | Model/Quantity | | P10-P250/2-50 | | | |
| Sound pressure level (measured in anechoic room) *4, 5 | | | dB <A> | | | |
| | | | 68.0/69.5 | | | |
| Sound power level (measured in anechoic room) *4 | | | dB <A> | | | |
| | | | 85/88 | | | |
| Refrigerant piping diameter | Liquid pipe | mm (in.) | 19.05 (3/4) Brazed | | | |
| | Gas pipe | mm (in.) | 41.28 (1-5/8) Brazed | | | |

| | | | | | | |
|---------------------------------------|------------------------------|---------------------------------------------------------------------------------------------------------------------------------------------------------------------------------------------------------------------------------------------------------------|------------------------------------------------------------------|------------------------------------------------------------------------------------------------------|------------------------------------------------------------------|--|
| Set Model | | | | | | |
| Model | | PUHY-P250YNW-A1 (-BS) | | PUHY-P350YNW-A1 (-BS) | | |
| Model | | PUHY-P400YNW-A1 (-BS) | | | | |
| FAN | Type x Quantity | | Propeller fan x 1 | | Propeller fan x 2 | |
| | Air flow rate | m ³ /min | 185 | | 270 | |
| | | L/s | 3,083 | | 4,500 | |
| | | cfm | 6,532 | | 9,534 | |
| | Control, Driving mechanism | | Inverter-control, Direct-driven by motor | | Inverter-control, Direct-driven by motor | |
| | Motor output | | kW | | 0.46 x 2 | |
| | External static press. | | 0 Pa (0 mmH ₂ O) | | 0 Pa (0 mmH ₂ O) | |
| Compressor | Type | | Inverter scroll hermetic compressor | | Inverter scroll hermetic compressor | |
| | Starting method | | Inverter | | Inverter | |
| | Motor output | kW | 5.3 | | 8.6 | |
| | Case heater | kW | - | | - | |
| | Lubricant | | MEL32 | | MEL32 | |
| External finish | | Pre-coated galvanized steel sheets (+powder coating for -BS type) <MUNSELL 3Y 7.8/1.1 or similar> | | Pre-coated galvanized steel sheets (+powder coating for -BS type) <MUNSELL 3Y 7.8/1.1 or similar> | | |
| External dimension H x W x D | | mm | 1,858 (1,798 without legs) x 920 x 740 | | 1,858 (1,798 without legs) x 1,240 x 740 | |
| | | in. | 73-3/16 (70-13/16 without legs) x 36-1/4 x 29-3/16 | | 73-3/16 (70-13/16 without legs) x 48-7/8 x 29-3/16 | |
| Protection devices | High pressure protection | | High pressure sensor, High pressure switch at 4.15 MPa (601 psi) | | High pressure sensor, High pressure switch at 4.15 MPa (601 psi) | |
| | Inverter circuit (COMP./FAN) | | Over-current protection | | Over-current protection | |
| | Compressor | | - | | - | |
| | Fan motor | | - | | - | |
| Refrigerant | Type x original charge | | R410A x 6.5 kg (15 lbs) | | R410A x 9.8 kg (22 lbs) | |
| | Control | | LEV and HIC circuit | | LEV and HIC circuit | |
| Net weight | | kg (lbs) | 213 (470) | | 277 (611) | |
| Heat exchanger | | Salt-resistant cross fin & copper tube | | Salt-resistant cross fin & copper tube | | |
| HIC circuit (HIC: Heat Inter-Changer) | | Copper pipe, tube-in-tube structure | | Copper pipe, tube-in-tube structure | | |
| Pipe between unit and distributor | Liquid pipe | mm (in.) | 9.52 (3/8) Brazed | | 12.7 (1/2) Brazed | |
| | Gas pipe | mm (in.) | 22.2 (7/8) Brazed | | 28.58 (1-1/8) Brazed | |
| Defrosting method | | Auto-defrost mode (Reversed refrigerant cycle, Hot gas) | | | | |
| Drawing | External | KE94L023 | | KB94C1X1 | | |
| | Wiring | KE94L024 | | KE94L024 | | |
| Standard attachment | Document | Installation Manual | | | | |
| | Accessory | - | | | | |
| Optional parts | | Outdoor Twinning kit: CMY-Y300/BK3 Joint: CMY-Y102SS/LS-G2, CMY-Y202/302S-G2 Header: CMY-Y104/108/1010-G | | | | |
| Remarks | | Details on foundation work, duct work, insulation work, electrical wiring, power source switch, and other items shall be referred to the Installation Manual. Due to continuing improvement, above specifications may be subject to change without notice. | | | | |

| | | | |
|-------------------------------------------------------------------------------------------------------------------------------------------------------------------------------------------------------------------------------------------|--|-------------------------------------------------------------|------------------------------|
| Notes: | | Unit converter | |
| 1.Nominal cooling conditions (subject to JIS B8615-2) Indoor: 27°C D.B./19°C W.B. (81°F D.B./66°F W.B.), Outdoor: 35°C D.B. (95°F D.B.) Pipe length: 7.5 m (24-9/16 ft.), Level difference: 0 m (0 ft.) | | BTU/h | =kW x 3,412 |
| 2.Nominal heating conditions (subject to JIS B8615-2) Indoor: 20°C D.B. (68°F D.B.), Outdoor: 7°C D.B./6°C W.B. (45°F D.B./43°F W.B.) Pipe length: 7.5 m (24-9/16 ft.), Level difference: 0 m (0 ft.) | | cfm | =m ³ /min x 35.31 |
| 3.Nominal heating conditions (subject to JIS B8615-2) Indoor: 20°C D.B. (68°F D.B.), Outdoor: 7°C D.B./6°C W.B. (45°F D.B./43°F W.B.) Pipe length: 7.5 m (24-9/16 ft.), Level difference: 0 m (0 ft.) Eurovent registered | | lbs | =kg/0.4536 |
| 4.Cooling mode/Heating mode | | | |
| 5.The sound pressure level measured by the conventional method in JIS for reference purpose. | | | |
| 6.External static pressure option is available (30 Pa, 60 Pa, 80 Pa/3.1 mmH ₂ O, 6.1 mmH ₂ O, 8.2 mmH ₂ O). Consult your dealer about the specification when setting External static pressure option. | | *Above specification data is subject to rounding variation. | |

1. SPECIFICATIONS

Y-Series

PUHY-P-Y(S)NW-A1

| | | | | | | |
|--------------------------------------------------------|----------------|-------------|---------------------------------------|---------|--|--|
| Model | | | PUHY-P1050YSNW-A1 (-BS) | | | |
| Power source | | | 3-phase 4-wire 380-400-415 V 50/60 Hz | | | |
| Cooling capacity (Nominal) | *1 | kW | 118.0 | | | |
| | | BTU/h | 402,600 | | | |
| | Power input | kW | 36.41 | | | |
| | Current input | A | 61.4-58.3-56.2 | | | |
| | EER | kW/kW | 3.24 | | | |
| | | SEER | kW/kW | 6.47 | | |
| Temp. range of cooling | Indoor | W.B. | 15.0~24.0°C (59~75°F) | | | |
| | Outdoor | D.B. | -5.0~52.0°C (23~126°F) | | | |
| Heating capacity (Max) | *2 | kW | 132.0 | | | |
| | | BTU/h | 450,400 | | | |
| | Power input | kW | 33.08 | | | |
| | Current input | A | 55.8-53.0-51.1 | | | |
| | COP | kW/kW | 3.99 | | | |
| | (Nominal) | *3 | kW | 118.0 | | |
| | | | BTU/h | 402,600 | | |
| | | Power input | kW | 27.76 | | |
| Current input | | A | 46.8-44.5-42.9 | | | |
| | | COP | kW/kW | 4.25 | | |
| | | SCOP | kW/kW | 4.05 | | |
| Temp. range of heating | Indoor | D.B. | 15.0~27.0°C (59~81°F) | | | |
| | Outdoor | W.B. | -20.0~15.5°C (-4~60°F) | | | |
| Indoor unit connectable | Total capacity | | 50~130% of outdoor unit capacity | | | |
| | Model/Quantity | | P10~P250/3~50 | | | |
| Sound pressure level (measured in anechoic room) *4, 5 | | dB <A> | 68.5/70.5 | | | |
| Sound power level (measured in anechoic room) *4 | | dB <A> | 86/90 | | | |
| Refrigerant piping diameter | Liquid pipe | mm (in.) | 19.05 (3/4) Brazed | | | |
| | Gas pipe | mm (in.) | 41.28 (1-5/8) Brazed | | | |

| | | | | | | | | |
|---------------------------------------|------------------------------|----------------------------------------|---------------------------------------------------------------------------------------------------------------------------------------------------------------------------------------------------------------------------------------------------------------|----------------------------------------|------------------------------------------------------------------------------------------------------|----------------------------------------|------------------------------------------------------------------------------------------------------|--|
| Set Model | | | PUHY-P250YNW-A1 (-BS) | | PUHY-P400YNW-A1 (-BS) | | PUHY-P400YNW-A1 (-BS) | |
| FAN | Type x Quantity | | Propeller fan x 1 | | Propeller fan x 2 | | Propeller fan x 2 | |
| | Air flow rate | m ³ /min | 185 | | 300 | | 300 | |
| | | L/s | 3,083 | | 5,000 | | 5,000 | |
| | | cfm | 6,532 | | 10,593 | | 10,593 | |
| | Control, Driving mechanism | | Inverter-control, Direct-driven by motor | | Inverter-control, Direct-driven by motor | | Inverter-control, Direct-driven by motor | |
| | *6 Motor output | kW | 0.92 x 1 | | 0.46 x 2 | | 0.46 x 2 | |
| External static press. | | 0 Pa (0 mmH ₂ O) | | 0 Pa (0 mmH ₂ O) | | 0 Pa (0 mmH ₂ O) | | |
| Compressor | Type | | Inverter scroll hermetic compressor | | Inverter scroll hermetic compressor | | Inverter scroll hermetic compressor | |
| | Starting method | | Inverter | | Inverter | | Inverter | |
| | Motor output | kW | 5.3 | | 11.4 | | 11.4 | |
| | Case heater | kW | - | | - | | - | |
| Lubricant | | MEL32 | | MEL32 | | MEL32 | | |
| External finish | | | Pre-coated galvanized steel sheets (+powder coating for -BS type) <MUNSELL 3Y 7.8/1.1 or similar> | | Pre-coated galvanized steel sheets (+powder coating for -BS type) <MUNSELL 3Y 7.8/1.1 or similar> | | Pre-coated galvanized steel sheets (+powder coating for -BS type) <MUNSELL 3Y 7.8/1.1 or similar> | |
| External dimension H x W x D | | mm | 1,858 (1,798 without legs) x 920 x 740 | | 1,858 (1,798 without legs) x 1,240 x 740 | | 1,858 (1,798 without legs) x 1,240 x 740 | |
| | | in. | 73-3/16 (70-13/16 without legs) x 36-1/4 x 29-3/16 | | 73-3/16 (70-13/16 without legs) x 48-7/8 x 29-3/16 | | 73-3/16 (70-13/16 without legs) x 48-7/8 x 29-3/16 | |
| Protection devices | High pressure protection | | High pressure sensor, High pressure switch at 4.15 MPa (601 psi) | | High pressure sensor, High pressure switch at 4.15 MPa (601 psi) | | High pressure sensor, High pressure switch at 4.15 MPa (601 psi) | |
| | Inverter circuit (COMP./FAN) | | Over-current protection | | Over-current protection | | Over-current protection | |
| | Compressor | | - | | - | | - | |
| | Fan motor | | - | | - | | - | |
| Refrigerant | Type x original charge | | R410A x 6.5 kg (15 lbs) | | R410A x 9.8 kg (22 lbs) | | R410A x 9.8 kg (22 lbs) | |
| | Control | | | | LEV and HIC circuit | | | |
| Net weight | kg (lbs) | 213 (470) | | 277 (611) | | 277 (611) | | |
| Heat exchanger | | Salt-resistant cross fin & copper tube | | Salt-resistant cross fin & copper tube | | Salt-resistant cross fin & copper tube | | |
| HIC circuit (HIC: Heat Inter-Changer) | | Copper pipe, tube-in-tube structure | | Copper pipe, tube-in-tube structure | | Copper pipe, tube-in-tube structure | | |
| Pipe between unit and distributor | Liquid pipe | mm (in.) | 9.52 (3/8) Brazed | | 15.88 (5/8) Brazed | | 15.88 (5/8) Brazed | |
| | Gas pipe | mm (in.) | 22.2 (7/8) Brazed | | 28.58 (1-1/8) Brazed | | 28.58 (1-1/8) Brazed | |
| Defrosting method | | | Auto-defrost mode (Reversed refrigerant cycle, Hot gas) | | | | | |
| Drawing | External | | KE94L023 | | KE94L024 | | KE94L024 | |
| | Wiring | | | | | | | |
| Standard attachment | Document | | Installation Manual | | | | | |
| | Accessory | | - | | | | | |
| Optional parts | | | Outdoor Twinning kit: CMY-Y300VBK3 Joint: CMY-Y102SS/LS-G2, CMY-Y202/302S-G2 Header: CMY-Y104/108/1010-G | | | | | |
| Remarks | | | Details on foundation work, duct work, insulation work, electrical wiring, power source switch, and other items shall be referred to the Installation Manual. Due to continuing improvement, above specifications may be subject to change without notice. | | | | | |

| | |
|--------------------------------------------------------------------------------------------------------------------------------------------------------------------------------------------------------------------------------------------|-------------------------------------------------------------|
| Notes: | Unit converter |
| 1. Nominal cooling conditions (subject to JIS B8615-2) Indoor: 27°C D.B./19°C W.B. (81°F D.B./66°F W.B.), Outdoor: 35°C D.B. (95°F D.B.) Pipe length: 7.5 m (24-9/16 ft.), Level difference: 0 m (0 ft.) | BTU/h =kW x 3,412 |
| 2. Nominal heating conditions (subject to JIS B8615-2) Indoor: 20°C D.B. (68°F D.B.), Outdoor: 7°C D.B./6°C W.B. (45°F D.B./43°F W.B.) Pipe length: 7.5 m (24-9/16 ft.), Level difference: 0 m (0 ft.) | cfm =m ³ /min x 35.31 |
| 3. Nominal heating conditions (subject to JIS B8615-2) Indoor: 20°C D.B. (68°F D.B.), Outdoor: 7°C D.B./6°C W.B. (45°F D.B./43°F W.B.) Pipe length: 7.5 m (24-9/16 ft.), Level difference: 0 m (0 ft.) Eurovent registered | lbs =kg/0.4536 |
| 4. Cooling mode/Heating mode | |
| 5. The sound pressure level measured by the conventional method in JIS for reference purpose. | |
| 6. External static pressure option is available (30 Pa, 60 Pa, 80 Pa/3.1 mmH ₂ O, 6.1 mmH ₂ O, 8.2 mmH ₂ O). Consult your dealer about the specification when setting External static pressure option. | *Above specification data is subject to rounding variation. |

1. SPECIFICATIONS

| | | | | | |
|--------------------------------------------------------|----------------|-----------------|---------------------------------------|--|--|
| Model | | | PUHY-P1100YSNW-A1 (-BS) | | |
| Power source | | | 3-phase 4-wire 380-400-415 V 50/60 Hz | | |
| Cooling capacity (Nominal) | | *1 kW | 124.0 | | |
| | | BTU/h | 423,100 | | |
| | | Power input kW | 36.79 | | |
| | | Current input A | 62.1-59.0-56.8 | | |
| | | EER | 3.37 | | |
| | | SEER | 6.49 | | |
| Temp. range of cooling | Indoor | W.B. | 15.0-24.0°C (59-75°F) | | |
| | Outdoor | D.B. | -5.0-52.0°C (23-126°F) | | |
| Heating capacity (Max) | (Nominal) | *2 kW | 140.0 | | |
| | | BTU/h | 477,700 | | |
| | | Power input kW | 34.22 | | |
| | | Current input A | 57.7-54.8-52.8 | | |
| | | COP | 4.09 | | |
| | | *3 kW | 124.0 | | |
| | | BTU/h | 423,100 | | |
| | | Power input kW | 28.44 | | |
| Temp. range of heating | Indoor | D.B. | 15.0-27.0°C (59-81°F) | | |
| | Outdoor | W.B. | -20.0-15.5°C (-4-60°F) | | |
| Indoor unit connectable | Total capacity | | 50-130% of outdoor unit capacity | | |
| | Model/Quantity | | P10-P250/3-50 | | |
| Sound pressure level (measured in anechoic room) *4, 5 | | | dB <A> | | |
| | | | 68.5/70.0 | | |
| Sound power level (measured in anechoic room) *4 | | | dB <A> | | |
| | | | 86/89 | | |
| Refrigerant piping diameter | Liquid pipe | mm (in.) | 19.05 (3/4) Brazed | | |
| | Gas pipe | mm (in.) | 41.28 (1-5/8) Brazed | | |

| | | | | | | |
|---------------------------------------|------------------------------|---------------------------------------------------------------------------------------------------------------------------------------------------------------------------------------------------------------------------------------------------------------|------------------------------------------------------------------|------------------------------------------------------------------------------------------------------|------------------------------------------------------------------|--|
| Set Model | | | | | | |
| Model | | PUHY-P350YNW-A1 (-BS) | | PUHY-P350YNW-A1 (-BS) | | |
| FAN | Type x Quantity | | Propeller fan x 2 | | Propeller fan x 2 | |
| | Air flow rate | m ³ /min | 270 | | 300 | |
| | | L/s | 4,500 | | 5,000 | |
| | | cfm | 9,534 | | 10,593 | |
| | Control, Driving mechanism | | Inverter-control, Direct-driven by motor | | Inverter-control, Direct-driven by motor | |
| | Motor output | kW | 0.46 x 2 | | 0.46 x 2 | |
| | *6 External static press. | | 0 Pa (0 mmH ₂ O) | | 0 Pa (0 mmH ₂ O) | |
| Compressor | Type | | Inverter scroll hermetic compressor | | Inverter scroll hermetic compressor | |
| | Starting method | | Inverter | | Inverter | |
| | Motor output | kW | 8.6 | | 11.4 | |
| | Case heater | | - | | - | |
| | Lubricant | | MEL32 | | MEL32 | |
| External finish | | Pre-coated galvanized steel sheets (+powder coating for -BS type) <MUNSELL 3Y 7.8/1.1 or similar> | | Pre-coated galvanized steel sheets (+powder coating for -BS type) <MUNSELL 3Y 7.8/1.1 or similar> | | |
| External dimension H x W x D | | mm | 1,858 (1,798 without legs) x 1,240 x 740 | | 1,858 (1,798 without legs) x 1,240 x 740 | |
| | | in. | 73-3/16 (70-13/16 without legs) x 48-7/8 x 29-3/16 | | 73-3/16 (70-13/16 without legs) x 48-7/8 x 29-3/16 | |
| Protection devices | High pressure protection | | High pressure sensor, High pressure switch at 4.15 MPa (601 psi) | | High pressure sensor, High pressure switch at 4.15 MPa (601 psi) | |
| | Inverter circuit (COMP./FAN) | | Over-current protection | | Over-current protection | |
| | Compressor | | - | | - | |
| | Fan motor | | - | | - | |
| Refrigerant | Type x original charge | | R410A x 9.8 kg (22 lbs) | | R410A x 9.8 kg (22 lbs) | |
| | Control | | LEV and HIC circuit | | LEV and HIC circuit | |
| Net weight | | kg (lbs) | 277 (611) | | 277 (611) | |
| Heat exchanger | | Salt-resistant cross fin & copper tube | | Salt-resistant cross fin & copper tube | | |
| HIC circuit (HIC: Heat Inter-Changer) | | Copper pipe, tube-in-tube structure | | Copper pipe, tube-in-tube structure | | |
| Pipe between unit and distributor | Liquid pipe | mm (in.) | 12.7 (1/2) Brazed | | 15.88 (5/8) Brazed | |
| | Gas pipe | mm (in.) | 28.58 (1-1/8) Brazed | | 28.58 (1-1/8) Brazed | |
| Defrosting method | | Auto-defrost mode (Reversed refrigerant cycle, Hot gas) | | | | |
| Drawing | External | KE94L024 | | KB94C1X2 | | |
| | Wiring | KE94L024 | | KE94L024 | | |
| Standard attachment | Document | Installation Manual | | | | |
| | Accessory | - | | | | |
| Optional parts | | Outdoor Twinning kit: CMY-Y300/BK3 Joint: CMY-Y102SS/LS-G2, CMY-Y202/302S-G2 Header: CMY-Y104/108/1010-G | | | | |
| Remarks | | Details on foundation work, duct work, insulation work, electrical wiring, power source switch, and other items shall be referred to the Installation Manual. Due to continuing improvement, above specifications may be subject to change without notice. | | | | |

| | | |
|--------|-------------------------------------------------------------------------------------------------------------------------------------------------------------------------------------------------------------------------------------------|-------------------------------------------------------------------------------------------|
| Notes: | 1.Nominal cooling conditions (subject to JIS B8615-2) Indoor: 27°C D.B./19°C W.B. (81°F D.B./66°F W.B.), Outdoor: 35°C D.B. (95°F D.B.) Pipe length: 7.5 m (24-9/16 ft.), Level difference: 0 m (0 ft.) | Unit converter BTU/h =kW x 3,412 cfm =m ³ /min x 35.31 lbs =kg/0.4536 |
| | 2.Nominal heating conditions (subject to JIS B8615-2) Indoor: 20°C D.B. (68°F D.B.), Outdoor: 7°C D.B./6°C W.B. (45°F D.B./43°F W.B.) Pipe length: 7.5 m (24-9/16 ft.), Level difference: 0 m (0 ft.) | |
| | 3.Nominal heating conditions (subject to JIS B8615-2) Indoor: 20°C D.B. (68°F D.B.), Outdoor: 7°C D.B./6°C W.B. (45°F D.B./43°F W.B.) Pipe length: 7.5 m (24-9/16 ft.), Level difference: 0 m (0 ft.) Eurovent registered | |
| | 4.Cooling mode/Heating mode | |
| | 5.The sound pressure level measured by the conventional method in JIS for reference purpose. | |
| | 6.External static pressure option is available (30 Pa, 60 Pa, 80 Pa/3.1 mmH ₂ O, 6.1 mmH ₂ O, 8.2 mmH ₂ O). Consult your dealer about the specification when setting External static pressure option. | |
| | | *Above specification data is subject to rounding variation. |

1. SPECIFICATIONS

Y-Series

PUHY-P-Y(S)NW-A1

| | | | | | | |
|--------------------------------------------------------|----------------|----------------------------------|---------------------------------------|----------------|--|--|
| Model | | | PUHY-P1150YSNW-A1 (-BS) | | | |
| Power source | | | 3-phase 4-wire 380-400-415 V 50/60 Hz | | | |
| Cooling capacity (Nominal) | *1 | kW | 130.0 | | | |
| | | BTU/h | 443,600 | | | |
| | | Power input kW | 40.49 | | | |
| | | Current input A | 68.3-64.9-62.5 | | | |
| | | EER | 3.21 | | | |
| | | SEER | 6.38 | | | |
| Temp. range of cooling | Indoor | W.B. | 15.0~24.0°C (59~75°F) | | | |
| | Outdoor | D.B. | -5.0~52.0°C (23~126°F) | | | |
| Heating capacity (Max) | *2 | kW | 145.0 | | | |
| | | BTU/h | 494,700 | | | |
| | | Power input kW | 36.25 | | | |
| | | Current input A | 61.1-58.1-56.0 | | | |
| | | COP | 4.00 | | | |
| | (Nominal) | *3 | kW | 130.0 | | |
| | | | BTU/h | 443,600 | | |
| | | | Power input kW | 30.51 | | |
| | | | Current input A | 51.5-48.9-47.1 | | |
| | | | COP | 4.26 | | |
| | | SCOP | 4.03 | | | |
| Temp. range of heating | Indoor | D.B. | 15.0~27.0°C (59~81°F) | | | |
| | Outdoor | W.B. | -20.0~15.5°C (-4~60°F) | | | |
| Indoor unit connectable | Total capacity | 50~130% of outdoor unit capacity | | | | |
| | Model/Quantity | P10~P250/3~50 | | | | |
| Sound pressure level (measured in anechoic room) *4, 5 | | dB <A> | 69.0/71.0 | | | |
| Sound power level (measured in anechoic room) *4 | | dB <A> | 86/90 | | | |
| Refrigerant piping diameter | Liquid pipe | mm (in.) | 19.05 (3/4) Brazed | | | |
| | Gas pipe | mm (in.) | 41.28 (1-5/8) Brazed | | | |

| | | | | | | |
|---------------------------------------|----------------------------------------|---------------------------------------------------------------------------------------------------------------------------------------------------------------------------------------------------------------------------------------------------------------|----------------------------------------------------|------------------------------------------------------------------------------------------------------|----------------------------------------------------|--|
| Set Model | | | | | | |
| Model | | PUHY-P350YNW-A1 (-BS) | | PUHY-P400YNW-A1 (-BS) | | |
| FAN | Type x Quantity | Propeller fan x 2 | | Propeller fan x 2 | | |
| | Air flow rate | m ³ /min | 270 | 300 | 300 | |
| | | L/s | 4,500 | 5,000 | 5,000 | |
| | | cfm | 9,534 | 10,593 | 10,593 | |
| | Control, Driving mechanism | | Inverter-control, Direct-driven by motor | | Inverter-control, Direct-driven by motor | |
| | Motor output | kW | 0.46 x 2 | | 0.46 x 2 | |
| *6 External static press. | 0 Pa (0 mmH ₂ O) | | 0 Pa (0 mmH ₂ O) | | 0 Pa (0 mmH ₂ O) | |
| Compressor | Type | Inverter scroll hermetic compressor | | Inverter scroll hermetic compressor | | |
| | Starting method | Inverter | | Inverter | | |
| | Motor output | kW | 8.6 | 11.4 | 11.4 | |
| | Case heater | kW | - | - | - | |
| | Lubricant | MEL32 | | MEL32 | | |
| External finish | | Pre-coated galvanized steel sheets (+powder coating for -BS type) <MUNSELL 3Y 7.8/1.1 or similar> | | Pre-coated galvanized steel sheets (+powder coating for -BS type) <MUNSELL 3Y 7.8/1.1 or similar> | | |
| External dimension H x W x D | | mm | 1,858 (1,798 without legs) x 1,240 x 740 | 1,858 (1,798 without legs) x 1,240 x 740 | 1,858 (1,798 without legs) x 1,240 x 740 | |
| | | in. | 73-3/16 (70-13/16 without legs) x 48-7/8 x 29-3/16 | 73-3/16 (70-13/16 without legs) x 48-7/8 x 29-3/16 | 73-3/16 (70-13/16 without legs) x 48-7/8 x 29-3/16 | |
| Protection devices | High pressure protection | High pressure sensor, High pressure switch at 4.15 MPa (601 psi) | | High pressure sensor, High pressure switch at 4.15 MPa (601 psi) | | |
| | Inverter circuit (COMP./FAN) | Over-current protection | | Over-current protection | | |
| | Compressor | - | | - | | |
| | Fan motor | - | | - | | |
| Refrigerant | Type x original charge | R410A x 9.8 kg (22 lbs) | | R410A x 9.8 kg (22 lbs) | | |
| | Control | LEV and HIC circuit | | | | |
| Net weight | kg (lbs) | 277 (611) | | 277 (611) | | |
| Heat exchanger | Salt-resistant cross fin & copper tube | | Salt-resistant cross fin & copper tube | | Salt-resistant cross fin & copper tube | |
| HIC circuit (HIC: Heat Inter-Changer) | | Copper pipe, tube-in-tube structure | | Copper pipe, tube-in-tube structure | | |
| Pipe between unit and distributor | Liquid pipe | mm (in.) | 12.7 (1/2) Brazed | 15.88 (5/8) Brazed | 15.88 (5/8) Brazed | |
| | Gas pipe | mm (in.) | 28.58 (1-1/8) Brazed | 28.58 (1-1/8) Brazed | 28.58 (1-1/8) Brazed | |
| Defrosting method | | Auto-defrost mode (Reversed refrigerant cycle, Hot gas) | | | | |
| Drawing | External | KB94C1X2 | | | | |
| | Wiring | KE94L024 | KE94L024 | KE94L024 | | |
| Standard attachment | Document | Installation Manual | | | | |
| | Accessory | - | | | | |
| Optional parts | | Outdoor Twinning kit: CMY-Y300VBK3 Joint: CMY-Y102SS/LS-G2, CMY-Y202/302S-G2 Header: CMY-Y104/108/1010-G | | | | |
| Remarks | | Details on foundation work, duct work, insulation work, electrical wiring, power source switch, and other items shall be referred to the Installation Manual. Due to continuing improvement, above specifications may be subject to change without notice. | | | | |

| | | |
|-------------------------------------------------------------------------------------------------------------------------------------------------------------------------------------------------------------------------------------------|--|-------------------------------------------------------------|
| Notes: | | Unit converter |
| 1.Nominal cooling conditions (subject to JIS B8615-2) Indoor: 27°C D.B./19°C W.B. (81°F D.B./66°F W.B.), Outdoor: 35°C D.B. (95°F D.B.) Pipe length: 7.5 m (24-9/16 ft.), Level difference: 0 m (0 ft.) | | BTU/h =kW x 3,412 |
| 2.Nominal heating conditions (subject to JIS B8615-2) Indoor: 20°C D.B. (68°F D.B.), Outdoor: 7°C D.B./6°C W.B. (45°F D.B./43°F W.B.) Pipe length: 7.5 m (24-9/16 ft.), Level difference: 0 m (0 ft.) | | cfm =m ³ /min x 35.31 |
| 3.Nominal heating conditions (subject to JIS B8615-2) Indoor: 20°C D.B. (68°F D.B.), Outdoor: 7°C D.B./6°C W.B. (45°F D.B./43°F W.B.) Pipe length: 7.5 m (24-9/16 ft.), Level difference: 0 m (0 ft.) Eurovent registered | | lbs =kg/0.4536 |
| 4.Cooling mode/Heating mode | | |
| 5.The sound pressure level measured by the conventional method in JIS for reference purpose. | | |
| 6.External static pressure option is available (30 Pa, 60 Pa, 80 Pa/3.1 mmH ₂ O, 6.1 mmH ₂ O, 8.2 mmH ₂ O). Consult your dealer about the specification when setting External static pressure option. | | *Above specification data is subject to rounding variation. |

1. SPECIFICATIONS

| | | | | | | |
|--------------------------------------------------------|----------------|-----------------|---------------------------------------|----------------|--|--|
| Model | | | PUHY-P1200YSNW-A1 (-BS) | | | |
| Power source | | | 3-phase 4-wire 380-400-415 V 50/60 Hz | | | |
| Cooling capacity (Nominal) | | *1 kW | 136.0 | | | |
| | | BTU/h | 464,000 | | | |
| | | Power input kW | 44.29 | | | |
| | | Current input A | 74.7-71.0-68.4 | | | |
| | | EER | 3.07 | | | |
| | | SEER | 6.29 | | | |
| Temp. range of cooling | Indoor | W.B. | 15.0-24.0°C (59-75°F) | | | |
| | Outdoor | D.B. | -5.0-52.0°C (23-126°F) | | | |
| Heating capacity (Max) | (Nominal) | *2 kW | 150.0 | | | |
| | | BTU/h | 511,800 | | | |
| | | Power input kW | 38.36 | | | |
| | | Current input A | 64.7-61.5-59.2 | | | |
| | | COP | 3.91 | | | |
| | | | *3 kW | 136.0 | | |
| | | | BTU/h | 464,000 | | |
| | | | Power input kW | 32.61 | | |
| | | | Current input A | 55.0-52.2-50.4 | | |
| | | | SCOP | 4.01 | | |
| Temp. range of heating | Indoor | D.B. | 15.0-27.0°C (59-81°F) | | | |
| | Outdoor | W.B. | -20.0-15.5°C (-4-60°F) | | | |
| Indoor unit connectable | Total capacity | | 50-130% of outdoor unit capacity | | | |
| | Model/Quantity | | P10-P250/3-50 | | | |
| Sound pressure level (measured in anechoic room) *4, 5 | | | dB <A> | | | |
| | | | 70.0/72.0 | | | |
| Sound power level (measured in anechoic room) *4 | | | dB <A> | | | |
| | | | 87/91 | | | |
| Refrigerant piping diameter | Liquid pipe | mm (in.) | 19.05 (3/4) Brazed | | | |
| | Gas pipe | mm (in.) | 41.28 (1-5/8) Brazed | | | |

| | | | | | | |
|---------------------------------------|------------------------------|---------------------------------------------------------------------------------------------------------------------------------------------------------------------------------------------------------------------------------------------------------------|------------------------------------------------------------------|------------------------------------------------------------------------------------------------------|------------------------------------------------------------------|--|
| Set Model | | | | | | |
| Model | | PUHY-P400YNW-A1 (-BS) | | PUHY-P400YNW-A1 (-BS) | | |
| FAN | Type x Quantity | | Propeller fan x 2 | | Propeller fan x 2 | |
| | Air flow rate | m ³ /min | 300 | | 300 | |
| | | L/s | 5,000 | | 5,000 | |
| | | cfm | 10,593 | | 10,593 | |
| | Control, Driving mechanism | | Inverter-control, Direct-driven by motor | | Inverter-control, Direct-driven by motor | |
| | Motor output | kW | 0.46 x 2 | | 0.46 x 2 | |
| | | *6 External static press. | 0 Pa (0 mmH ₂ O) | | 0 Pa (0 mmH ₂ O) | |
| Compressor | Type | | Inverter scroll hermetic compressor | | Inverter scroll hermetic compressor | |
| | Starting method | | Inverter | | Inverter | |
| | Motor output | kW | 11.4 | | 11.4 | |
| | Case heater | kW | - | | - | |
| | Lubricant | | MEL32 | | MEL32 | |
| External finish | | Pre-coated galvanized steel sheets (+powder coating for -BS type) <MUNSELL 3Y 7.8/1.1 or similar> | | Pre-coated galvanized steel sheets (+powder coating for -BS type) <MUNSELL 3Y 7.8/1.1 or similar> | | |
| External dimension H x W x D | | mm | 1,858 (1,798 without legs) x 1,240 x 740 | | 1,858 (1,798 without legs) x 1,240 x 740 | |
| | | in. | 73-3/16 (70-13/16 without legs) x 48-7/8 x 29-3/16 | | 73-3/16 (70-13/16 without legs) x 48-7/8 x 29-3/16 | |
| Protection devices | High pressure protection | | High pressure sensor, High pressure switch at 4.15 MPa (601 psi) | | High pressure sensor, High pressure switch at 4.15 MPa (601 psi) | |
| | Inverter circuit (COMP./FAN) | | Over-current protection | | Over-current protection | |
| | Compressor | | - | | - | |
| | Fan motor | | - | | - | |
| Refrigerant | Type x original charge | | R410A x 9.8 kg (22 lbs) | | R410A x 9.8 kg (22 lbs) | |
| | Control | | LEV and HIC circuit | | LEV and HIC circuit | |
| Net weight | | kg (lbs) | 277 (611) | | 277 (611) | |
| Heat exchanger | | Salt-resistant cross fin & copper tube | | Salt-resistant cross fin & copper tube | | |
| HIC circuit (HIC: Heat Inter-Changer) | | Copper pipe, tube-in-tube structure | | Copper pipe, tube-in-tube structure | | |
| Pipe between unit and distributor | Liquid pipe | mm (in.) | 15.88 (5/8) Brazed | | 15.88 (5/8) Brazed | |
| | Gas pipe | mm (in.) | 28.58 (1-1/8) Brazed | | 28.58 (1-1/8) Brazed | |
| Defrosting method | | Auto-defrost mode (Reversed refrigerant cycle, Hot gas) | | | | |
| Drawing | External | KE94L024 | | KB94C1X2 | | |
| | Wiring | KE94L024 | | KE94L024 | | |
| Standard attachment | Document | Installation Manual | | | | |
| | Accessory | - | | | | |
| Optional parts | | Outdoor Twinning kit: CMY-Y300/BK3 Joint: CMY-Y102SS/LS-G2, CMY-Y202/302S-G2 Header: CMY-Y104/108/1010-G | | | | |
| Remarks | | Details on foundation work, duct work, insulation work, electrical wiring, power source switch, and other items shall be referred to the Installation Manual. Due to continuing improvement, above specifications may be subject to change without notice. | | | | |

| | | | |
|-------------------------------------------------------------------------------------------------------------------------------------------------------------------------------------------------------------------------------------------|--|-------------------------------------------------------------|------------------------------|
| Notes: | | Unit converter | |
| 1.Nominal cooling conditions (subject to JIS B8615-2) Indoor: 27°C D.B./19°C W.B. (81°F D.B./66°F W.B.), Outdoor: 35°C D.B. (95°F D.B.) Pipe length: 7.5 m (24-9/16 ft.), Level difference: 0 m (0 ft.) | | BTU/h | =kW x 3,412 |
| 2.Nominal heating conditions (subject to JIS B8615-2) Indoor: 20°C D.B. (68°F D.B.), Outdoor: 7°C D.B./6°C W.B. (45°F D.B./43°F W.B.) Pipe length: 7.5 m (24-9/16 ft.), Level difference: 0 m (0 ft.) | | cfm | =m ³ /min x 35.31 |
| 3.Nominal heating conditions (subject to JIS B8615-2) Indoor: 20°C D.B. (68°F D.B.), Outdoor: 7°C D.B./6°C W.B. (45°F D.B./43°F W.B.) Pipe length: 7.5 m (24-9/16 ft.), Level difference: 0 m (0 ft.) Eurovent registered | | lbs | =kg/0.4536 |
| 4.Cooling mode/Heating mode | | | |
| 5.The sound pressure level measured by the conventional method in JIS for reference purpose. | | | |
| 6.External static pressure option is available (30 Pa, 60 Pa, 80 Pa/3.1 mmH ₂ O, 6.1 mmH ₂ O, 8.2 mmH ₂ O). Consult your dealer about the specification when setting External static pressure option. | | *Above specification data is subject to rounding variation. | |

1. SPECIFICATIONS

Y-Series

PUHY-P-Y(S)NW-A1

| | | | |
|--------------------------------------------------------|-----------------|---------------------------------------|------------------------|
| Model | | PUHY-P1250YSNW-A1 (-BS) | |
| Power source | | 3-phase 4-wire 380-400-415 V 50/60 Hz | |
| Cooling capacity (Nominal) | *1 kW | 140.0 | |
| | BTU/h | 477,700 | |
| | Power input kW | 44.30 | |
| | Current input A | 74.7-71.0-68.4 | |
| | EER | 3.16 | |
| | SEER | 6.30 | |
| Temp. range of cooling | Indoor | W.B. | 15.0~24.0°C (59~75°F) |
| | Outdoor | D.B. | -5.0~52.0°C (23~126°F) |
| Heating capacity (Max) | *2 kW | 156.5 | |
| | BTU/h | 534,000 | |
| | Power input kW | 40.12 | |
| | Current input A | 67.7-64.3-62.0 | |
| | COP | 3.90 | |
| (Nominal) | *3 kW | 140.0 | |
| | BTU/h | 477,700 | |
| | Power input kW | 33.65 | |
| | Current input A | 56.8-53.9-52.0 | |
| | COP | 4.16 | |
| | SCOP | 3.91 | |
| Temp. range of heating | Indoor | D.B. | 15.0~27.0°C (59~81°F) |
| | Outdoor | W.B. | -20.0~15.5°C (-4~60°F) |
| Indoor unit connectable | Total capacity | 50~130% of outdoor unit capacity | |
| | Model/Quantity | P10~P250/3~50 | |
| Sound pressure level (measured in anechoic room) *4, 5 | dB <A> | 70.0/73.0 | |
| Sound power level (measured in anechoic room) *4 | dB <A> | 88/92 | |
| Refrigerant piping diameter | Liquid pipe | 19.05 (3/4) Brazed | |
| | Gas pipe | 41.28 (1-5/8) Brazed | |

| | | | | | | |
|---------------------------------------|---------------------------------------------------------------------------------------------------------------------------------------------------------------------------------------------------------------------------------------------------------------|------------------------------------------------------------------|-------------------------------------------------------------------|------------------------------------------------------------------|-------------------------------------------------------------------|--|
| Set Model | | | | | | |
| Model | | PUHY-P400YNW-A1 (-BS) | PUHY-P400YNW-A1 (-BS) | PUHY-P450YNW-A1 (-BS) | | |
| FAN | Type x Quantity | Propeller fan x 2 | | | | |
| | Air flow rate | m ³ /min | 300 | 300 | 305 | |
| | | L/s | 5,000 | 5,000 | 5,083 | |
| | | cfm | 10,593 | 10,593 | 10,770 | |
| | Control, Driving mechanism | Inverter-control, Direct-driven by motor | | | | |
| | *6 Motor output | kW | 0.46 x 2 | | | |
| External static press. | 0 Pa (0 mmH ₂ O) | | | | | |
| Compressor | Type | Inverter scroll hermetic compressor | | | | |
| | Starting method | Inverter | | | | |
| | Motor output | kW | 11.4 | | | |
| | Case heater | kW | - | | | |
| Lubricant | MEL32 | | | | | |
| External finish | Pre-coated galvanized steel sheets (+powder coating for -BS type) | | Pre-coated galvanized steel sheets (+powder coating for -BS type) | | Pre-coated galvanized steel sheets (+powder coating for -BS type) | |
| | <MUNSELL 3Y 7.8/1.1 or similar> | | <MUNSELL 3Y 7.8/1.1 or similar> | | <MUNSELL 3Y 7.8/1.1 or similar> | |
| | External dimension H x W x D | | External dimension H x W x D | | External dimension H x W x D | |
| Protection devices | High pressure protection | High pressure sensor, High pressure switch at 4.15 MPa (601 psi) | | High pressure sensor, High pressure switch at 4.15 MPa (601 psi) | | |
| | Inverter circuit (COMP./FAN) | Over-current protection | | Over-current protection | | |
| | Compressor | - | | - | | |
| | Fan motor | - | | - | | |
| Refrigerant | Type x original charge | R410A x 9.8 kg (22 lbs) | | R410A x 9.8 kg (22 lbs) | | |
| | Control | LEV and HIC circuit | | | | |
| Net weight | kg (lbs) | 277 (611) | | 293 (646) | | |
| Heat exchanger | Salt-resistant cross fin & copper tube | | Salt-resistant cross fin & copper tube | | Salt-resistant cross fin & copper tube | |
| HIC circuit (HIC: Heat Inter-Changer) | Copper pipe, tube-in-tube structure | | Copper pipe, tube-in-tube structure | | Copper pipe, tube-in-tube structure | |
| Pipe between unit and distributor | Liquid pipe | mm (in.) | 15.88 (5/8) Brazed | 15.88 (5/8) Brazed | 15.88 (5/8) Brazed | |
| | Gas pipe | mm (in.) | 28.58 (1-1/8) Brazed | 28.58 (1-1/8) Brazed | 28.58 (1-1/8) Brazed | |
| Defrosting method | Auto-defrost mode (Reversed refrigerant cycle, Hot gas) | | | | | |
| Drawing | External | KB94C1X2 | | | | |
| | Wiring | KE94L024 | KE94L024 | KE94L024 | | |
| Standard attachment | Document | Installation Manual | | | | |
| | Accessory | - | | | | |
| Optional parts | Outdoor Twinning kit: CMY-Y300VBK3 Joint: CMY-Y102SS/LS-G2, CMY-Y202/302S-G2 Header: CMY-Y104/108/1010-G | | | | | |
| Remarks | Details on foundation work, duct work, insulation work, electrical wiring, power source switch, and other items shall be referred to the Installation Manual. Due to continuing improvement, above specifications may be subject to change without notice. | | | | | |

| | |
|--------------------------------------------------------------------------------------------------------------------------------------------------------------------------------------------------------------------------------------------|-------------------------------------------------------------|
| Notes: | Unit converter |
| 1. Nominal cooling conditions (subject to JIS B8615-2) Indoor: 27°C D.B./19°C W.B. (81°F D.B./66°F W.B.), Outdoor: 35°C D.B. (95°F D.B.) Pipe length: 7.5 m (24-9/16 ft.), Level difference: 0 m (0 ft.) | BTU/h =kW x 3,412 |
| 2. Nominal heating conditions (subject to JIS B8615-2) Indoor: 20°C D.B. (68°F D.B.), Outdoor: 7°C D.B./6°C W.B. (45°F D.B./43°F W.B.) Pipe length: 7.5 m (24-9/16 ft.), Level difference: 0 m (0 ft.) | cfm =m ³ /min x 35.31 |
| 3. Nominal heating conditions (subject to JIS B8615-2) Indoor: 20°C D.B. (68°F D.B.), Outdoor: 7°C D.B./6°C W.B. (45°F D.B./43°F W.B.) Pipe length: 7.5 m (24-9/16 ft.), Level difference: 0 m (0 ft.) Eurovent registered | lbs =kg/0.4536 |
| 4. Cooling mode/Heating mode | |
| 5. The sound pressure level measured by the conventional method in JIS for reference purpose. | |
| 6. External static pressure option is available (30 Pa, 60 Pa, 80 Pa/3.1 mmH ₂ O, 6.1 mmH ₂ O, 8.2 mmH ₂ O). Consult your dealer about the specification when setting External static pressure option. | *Above specification data is subject to rounding variation. |

1. SPECIFICATIONS

Y-Series

PUHY-P-Y(S)NW-A1

| | | | | | | |
|--------------------------------------------------------|----------------|-----------------|---------------------------------------|----------------|--|--|
| Model | | | PUHY-P1300YSNW-A1 (-BS) | | | |
| Power source | | | 3-phase 4-wire 380-400-415 V 50/60 Hz | | | |
| Cooling capacity (Nominal) | | *1 kW | 146.0 | | | |
| | | BTU/h | 498,200 | | | |
| | | Power input kW | 45.06 | | | |
| | | Current input A | 76.0-72.2-69.6 | | | |
| | | EER | 3.24 | | | |
| | | SEER | 6.32 | | | |
| Temp. range of cooling | Indoor | W.B. | 15.0-24.0°C (59-75°F) | | | |
| | Outdoor | D.B. | -5.0-52.0°C (23-126°F) | | | |
| Heating capacity (Max) | (Nominal) | *2 kW | 163.0 | | | |
| | | BTU/h | 556,200 | | | |
| | | Power input kW | 41.90 | | | |
| | | Current input A | 70.7-67.1-64.7 | | | |
| | | COP | 3.89 | | | |
| | | | *3 kW | 146.0 | | |
| | | | BTU/h | 498,200 | | |
| | | | Power input kW | 35.18 | | |
| | | | Current input A | 59.3-56.4-54.3 | | |
| | | | COP | 4.15 | | |
| | | SCOP | 3.81 | | | |
| Temp. range of heating | Indoor | D.B. | 15.0-27.0°C (59-81°F) | | | |
| | Outdoor | W.B. | -20.0-15.5°C (-4-60°F) | | | |
| Indoor unit connectable | Total capacity | | 50-130% of outdoor unit capacity | | | |
| | Model/Quantity | | P10-P250/3-50 | | | |
| Sound pressure level (measured in anechoic room) *4, 5 | | | dB <A> | | | |
| | | | 70.0/73.5 | | | |
| Sound power level (measured in anechoic room) *4 | | | dB <A> | | | |
| | | | 88/93 | | | |
| Refrigerant piping diameter | Liquid pipe | mm (in.) | 19.05 (3/4) Brazed | | | |
| | Gas pipe | mm (in.) | 41.28 (1-5/8) Brazed | | | |

| | | | | | | |
|---------------------------------------|------------------------------|---------------------------------------------------------------------------------------------------------------------------------------------------------------------------------------------------------------------------------------------------------------|------------------------------------------------------------------|------------------------------------------------------------------------------------------------------|------------------------------------------------------------------|--|
| Set Model | | | | | | |
| Model | | PUHY-P400YNW-A1 (-BS) | | PUHY-P450YNW-A1 (-BS) | | |
| FAN | Type x Quantity | | Propeller fan x 2 | | Propeller fan x 2 | |
| | Air flow rate | m ³ /min | 300 | | 305 | |
| | | L/s | 5,000 | | 5,083 | |
| | | cfm | 10,593 | | 10,770 | |
| | Control, Driving mechanism | | Inverter-control, Direct-driven by motor | | Inverter-control, Direct-driven by motor | |
| | Motor output | | kW | | 0.46 x 2 | |
| | *6 External static press. | | 0 Pa (0 mmH ₂ O) | | 0 Pa (0 mmH ₂ O) | |
| Compressor | Type | | Inverter scroll hermetic compressor | | Inverter scroll hermetic compressor | |
| | Starting method | | Inverter | | Inverter | |
| | Motor output | kW | 11.4 | | 11.7 | |
| | Case heater | kW | - | | - | |
| | Lubricant | | MEL32 | | MEL32 | |
| External finish | | Pre-coated galvanized steel sheets (+powder coating for -BS type) <MUNSELL 3Y 7.8/1.1 or similar> | | Pre-coated galvanized steel sheets (+powder coating for -BS type) <MUNSELL 3Y 7.8/1.1 or similar> | | |
| External dimension H x W x D | | mm | 1,858 (1,798 without legs) x 1,240 x 740 | | 1,858 (1,798 without legs) x 1,240 x 740 | |
| | | in. | 73-3/16 (70-13/16 without legs) x 48-7/8 x 29-3/16 | | 73-3/16 (70-13/16 without legs) x 48-7/8 x 29-3/16 | |
| Protection devices | High pressure protection | | High pressure sensor, High pressure switch at 4.15 MPa (601 psi) | | High pressure sensor, High pressure switch at 4.15 MPa (601 psi) | |
| | Inverter circuit (COMP./FAN) | | Over-current protection | | Over-current protection | |
| | Compressor | | - | | - | |
| | Fan motor | | - | | - | |
| Refrigerant | Type x original charge | | R410A x 9.8 kg (22 lbs) | | R410A x 10.8 kg (24 lbs) | |
| | Control | | LEV and HIC circuit | | LEV and HIC circuit | |
| Net weight | | kg (lbs) | 277 (611) | | 293 (646) | |
| Heat exchanger | | Salt-resistant cross fin & copper tube | | Salt-resistant cross fin & copper tube | | |
| HIC circuit (HIC: Heat Inter-Changer) | | Copper pipe, tube-in-tube structure | | Copper pipe, tube-in-tube structure | | |
| Pipe between unit and distributor | Liquid pipe | mm (in.) | 15.88 (5/8) Brazed | | 15.88 (5/8) Brazed | |
| | Gas pipe | mm (in.) | 28.58 (1-1/8) Brazed | | 28.58 (1-1/8) Brazed | |
| Defrosting method | | Auto-defrost mode (Reversed refrigerant cycle, Hot gas) | | | | |
| Drawing | External | KE94L024 | | KB94C1X2 | | |
| | Wiring | KE94L024 | | KE94L024 | | |
| Standard attachment | Document | Installation Manual | | | | |
| | Accessory | - | | | | |
| Optional parts | | Outdoor Twinning kit: CMY-Y300/BK3 Joint: CMY-Y102SS/LS-G2, CMY-Y202/302S-G2 Header: CMY-Y104/108/1010-G | | | | |
| Remarks | | Details on foundation work, duct work, insulation work, electrical wiring, power source switch, and other items shall be referred to the Installation Manual. Due to continuing improvement, above specifications may be subject to change without notice. | | | | |

| | | | |
|-------------------------------------------------------------------------------------------------------------------------------------------------------------------------------------------------------------------------------------------|--|-------------------------------------------------------------|------------------------------|
| Notes: | | Unit converter | |
| 1.Nominal cooling conditions (subject to JIS B8615-2) Indoor: 27°C D.B./19°C W.B. (81°F D.B./66°F W.B.), Outdoor: 35°C D.B. (95°F D.B.) Pipe length: 7.5 m (24-9/16 ft.), Level difference: 0 m (0 ft.) | | BTU/h | =kW x 3,412 |
| 2.Nominal heating conditions (subject to JIS B8615-2) Indoor: 20°C D.B. (68°F D.B.), Outdoor: 7°C D.B./6°C W.B. (45°F D.B./43°F W.B.) Pipe length: 7.5 m (24-9/16 ft.), Level difference: 0 m (0 ft.) | | cfm | =m ³ /min x 35.31 |
| 3.Nominal heating conditions (subject to JIS B8615-2) Indoor: 20°C D.B. (68°F D.B.), Outdoor: 7°C D.B./6°C W.B. (45°F D.B./43°F W.B.) Pipe length: 7.5 m (24-9/16 ft.), Level difference: 0 m (0 ft.) Eurovent registered | | lbs | =kg/0.4536 |
| 4.Cooling mode/Heating mode | | | |
| 5.The sound pressure level measured by the conventional method in JIS for reference purpose. | | | |
| 6.External static pressure option is available (30 Pa, 60 Pa, 80 Pa/3.1 mmH ₂ O, 6.1 mmH ₂ O, 8.2 mmH ₂ O). Consult your dealer about the specification when setting External static pressure option. | | *Above specification data is subject to rounding variation. | |

1. SPECIFICATIONS

Y-Series

PUHY-P-Y(S)NW-A1

| | | | | | | |
|--------------------------------------------------------|----------------|---------------|---------------------------------------|----------------|--|--|
| Model | | | PUHY-P1350YSNW-A1 (-BS) | | | |
| Power source | | | 3-phase 4-wire 380-400-415 V 50/60 Hz | | | |
| Cooling capacity (Nominal) | *1 | kW | 150.0 | | | |
| | | BTU/h | 511,800 | | | |
| | Power input | kW | 45.18 | | | |
| | Current input | A | 76.2-72.4-69.8 | | | |
| | EER | kW/kW | 3.32 | | | |
| | | SEER | kW/kW | 6.34 | | |
| Temp. range of cooling | Indoor | W.B. | 15.0~24.0°C (59~75°F) | | | |
| | Outdoor | D.B. | -5.0~52.0°C (23~126°F) | | | |
| Heating capacity (Max) | *2 | kW | 168.0 | | | |
| | | BTU/h | 573,200 | | | |
| | Power input | kW | 43.29 | | | |
| | Current input | A | 73.0-69.4-66.9 | | | |
| | COP | kW/kW | 3.88 | | | |
| | (Nominal) | *3 | kW | 150.0 | | |
| | | | BTU/h | 511,800 | | |
| Power input | | kW | 36.14 | | | |
| | | Current input | A | 61.0-57.9-55.8 | | |
| | | COP | kW/kW | 4.15 | | |
| | | SCOP | kW/kW | 3.71 | | |
| Temp. range of heating | Indoor | D.B. | 15.0~27.0°C (59~81°F) | | | |
| | Outdoor | W.B. | -20.0~15.5°C (-4~60°F) | | | |
| Indoor unit connectable | Total capacity | | 50~130% of outdoor unit capacity | | | |
| | Model/Quantity | | P10~P250/3~50 | | | |
| Sound pressure level (measured in anechoic room) *4, 5 | | | dB <A> | | | |
| Sound power level (measured in anechoic room) *4 | | | dB <A> | | | |
| Refrigerant piping diameter | Liquid pipe | mm (in.) | 19.05 (3/4) Brazed | | | |
| | Gas pipe | mm (in.) | 41.28 (1-5/8) Brazed | | | |

| | | | | | | | | | | | |
|---------------------------------------|------------------------------|-----------------------------|---------------------------------------------------------------------------------------------------------------------------------------------------------------------------------------------------------------------------------------------------------------|----------|-----------------------------|------------------------------------------------------------------------------------------------------|----------|-----------------------------|------------------------------------------------------------------------------------------------------|----------|--|
| Set Model | | | PUHY-P450YNW-A1 (-BS) | | | PUHY-P450YNW-A1 (-BS) | | | PUHY-P450YNW-A1 (-BS) | | |
| FAN | Type x Quantity | | Propeller fan x 2 | | | Propeller fan x 2 | | | Propeller fan x 2 | | |
| | Air flow rate | m ³ /min | 305 | | | 305 | | | 305 | | |
| | | L/s | 5,083 | | | 5,083 | | | 5,083 | | |
| | | cfm | 10,770 | | | 10,770 | | | 10,770 | | |
| | Control, Driving mechanism | | Inverter-control, Direct-driven by motor | | | Inverter-control, Direct-driven by motor | | | Inverter-control, Direct-driven by motor | | |
| | *6 | Motor output | kW | 0.46 x 2 | | | 0.46 x 2 | | | 0.46 x 2 | |
| External static press. | | 0 Pa (0 mmH ₂ O) | | | 0 Pa (0 mmH ₂ O) | | | 0 Pa (0 mmH ₂ O) | | | |
| Compressor | Type | | Inverter scroll hermetic compressor | | | Inverter scroll hermetic compressor | | | Inverter scroll hermetic compressor | | |
| | Starting method | | Inverter | | | Inverter | | | Inverter | | |
| | Motor output | kW | 11.7 | | | 11.7 | | | 11.7 | | |
| | Case heater | kW | - | | | - | | | - | | |
| Lubricant | | MEL32 | | | MEL32 | | | MEL32 | | | |
| External finish | | | Pre-coated galvanized steel sheets (+powder coating for -BS type) <MUNSELL 3Y 7.8/1.1 or similar> | | | Pre-coated galvanized steel sheets (+powder coating for -BS type) <MUNSELL 3Y 7.8/1.1 or similar> | | | Pre-coated galvanized steel sheets (+powder coating for -BS type) <MUNSELL 3Y 7.8/1.1 or similar> | | |
| External dimension H x W x D | | mm | 1,858 (1,798 without legs) x 1,240 x 740 | | | 1,858 (1,798 without legs) x 1,240 x 740 | | | 1,858 (1,798 without legs) x 1,240 x 740 | | |
| | | in. | 73-3/16 (70-13/16 without legs) x 48-7/8 x 29-3/16 | | | 73-3/16 (70-13/16 without legs) x 48-7/8 x 29-3/16 | | | 73-3/16 (70-13/16 without legs) x 48-7/8 x 29-3/16 | | |
| Protection devices | High pressure protection | | High pressure sensor, High pressure switch at 4.15 MPa (601 psi) | | | High pressure sensor, High pressure switch at 4.15 MPa (601 psi) | | | High pressure sensor, High pressure switch at 4.15 MPa (601 psi) | | |
| | Inverter circuit (COMP./FAN) | | Over-current protection | | | Over-current protection | | | Over-current protection | | |
| | Compressor | | - | | | - | | | - | | |
| | Fan motor | | - | | | - | | | - | | |
| Refrigerant | Type x original charge | | R410A x 10.8 kg (24 lbs) | | | R410A x 10.8 kg (24 lbs) | | | R410A x 10.8 kg (24 lbs) | | |
| | Control | | LEV and HIC circuit | | | LEV and HIC circuit | | | LEV and HIC circuit | | |
| Net weight | | kg (lbs) | 293 (646) | | | 293 (646) | | | 293 (646) | | |
| Heat exchanger | | | Salt-resistant cross fin & copper tube | | | Salt-resistant cross fin & copper tube | | | Salt-resistant cross fin & copper tube | | |
| HIC circuit (HIC: Heat Inter-Changer) | | | Copper pipe, tube-in-tube structure | | | Copper pipe, tube-in-tube structure | | | Copper pipe, tube-in-tube structure | | |
| Pipe between unit and distributor | Liquid pipe | mm (in.) | 15.88 (5/8) Brazed | | | 15.88 (5/8) Brazed | | | 15.88 (5/8) Brazed | | |
| | Gas pipe | mm (in.) | 28.58 (1-1/8) Brazed | | | 28.58 (1-1/8) Brazed | | | 28.58 (1-1/8) Brazed | | |
| Defrosting method | | | Auto-defrost mode (Reversed refrigerant cycle, Hot gas) | | | | | | | | |
| Drawing | External | | KB94C1X2 | | | | | | | | |
| | Wiring | | KE94L024 | | | KE94L024 | | | KE94L024 | | |
| Standard attachment | Document | | Installation Manual | | | | | | | | |
| | Accessory | | - | | | | | | | | |
| Optional parts | | | Outdoor Twinning kit: CMY-Y300VBK3 Joint: CMY-Y102SS/LS-G2, CMY-Y202/302S-G2 Header: CMY-Y104/108/1010-G | | | | | | | | |
| Remarks | | | Details on foundation work, duct work, insulation work, electrical wiring, power source switch, and other items shall be referred to the Installation Manual. Due to continuing improvement, above specifications may be subject to change without notice. | | | | | | | | |

| | | | |
|-------------------------------------------------------------------------------------------------------------------------------------------------------------------------------------------------------------------------------------------|--|----------------|-------------------------------------------------------------|
| Notes: | | Unit converter | |
| 1.Nominal cooling conditions (subject to JIS B8615-2) Indoor: 27°C D.B./19°C W.B. (81°F D.B./66°F W.B.), Outdoor: 35°C D.B. (95°F D.B.) Pipe length: 7.5 m (24-9/16 ft.), Level difference: 0 m (0 ft.) | | BTU/h | =kW x 3,412 |
| 2.Nominal heating conditions (subject to JIS B8615-2) Indoor: 20°C D.B. (68°F D.B.), Outdoor: 7°C D.B./6°C W.B. (45°F D.B./43°F W.B.) Pipe length: 7.5 m (24-9/16 ft.), Level difference: 0 m (0 ft.) | | cfm | =m ³ /min x 35.31 |
| 3.Nominal heating conditions (subject to JIS B8615-2) Indoor: 20°C D.B. (68°F D.B.), Outdoor: 7°C D.B./6°C W.B. (45°F D.B./43°F W.B.) Pipe length: 7.5 m (24-9/16 ft.), Level difference: 0 m (0 ft.) Eurovent registered | | lbs | =kg/0.4536 |
| 4.Cooling mode/Heating mode | | | |
| 5.The sound pressure level measured by the conventional method in JIS for reference purpose. | | | |
| 6.External static pressure option is available (30 Pa, 60 Pa, 80 Pa/3.1 mmH ₂ O, 6.1 mmH ₂ O, 8.2 mmH ₂ O). Consult your dealer about the specification when setting External static pressure option. | | | *Above specification data is subject to rounding variation. |

PUHY-P200, 250, 300YNW-A1 (-BS)

Unit: mm

Note 1. Please refer to the next page for information regarding necessary spacing around the unit and foundation work.
 2. The detachable leg can be removed at site.
 3. At brazing of pipes, wrap the refrigerant service valve with wet cloth and keep the temperature of refrigerant service valve under 120°C.

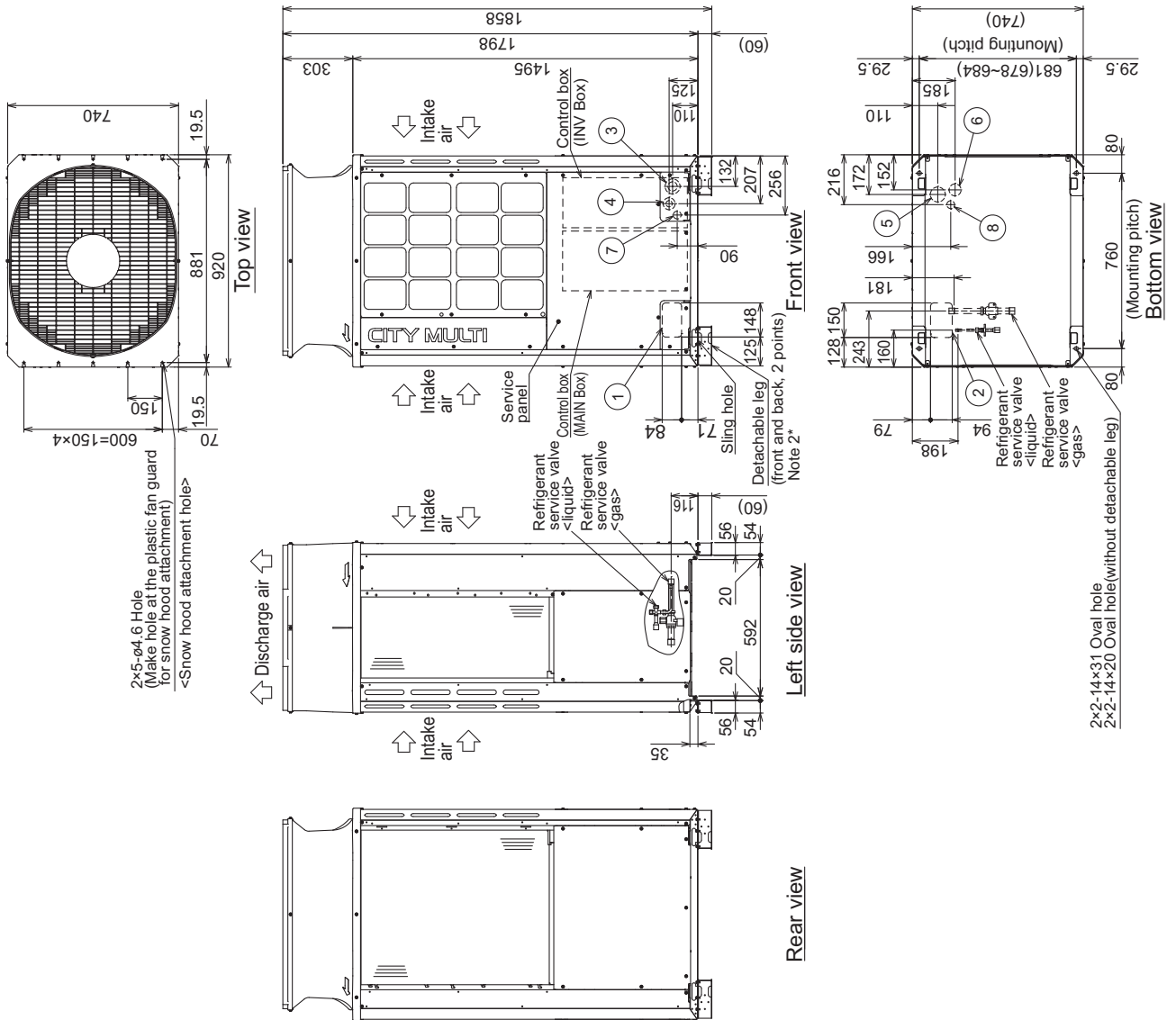

Connecting pipe specifications

| Model | Refrigerant pipe | | Service valve | |
|-------|----------------------------------------------|--------------|---------------|-------|
| | Liquid | Gas | Liquid | Gas |
| P200 | ø9.52 Brazed | | | |
| P250 | ø9.52 Brazed (ø12.7 Brazed) ^{1,3} | ø22.2 Brazed | ø9.52 | ø22.2 |
| P300 | ø9.52 Brazed (ø12.7 Brazed) ^{1,2,4} | | | |

- ¹ Connect the refrigerant pipe to the service valve according to the Installation Manual.
- ² Indicates dimensions and connection specifications in the case the unit is used in combination with other outdoor units.
- ³ Furthest piping length (OU from IU)≥90m
- ⁴ Furthest piping length (OU from IU)≥40m

| NO. | Usage | Specifications |
|-----|-------------------------|-----------------------------------------------|
| ① | For pipes | Front through hole : 148 x 84 Knockout hole |
| ② | | Bottom through hole : 150 x 94 Knockout hole |
| ③ | For wires | Front through hole : ø65 or ø40 Knockout hole |
| ④ | | Front through hole : ø52 or ø27 Knockout hole |
| ⑤ | | Bottom through hole : ø65 Knockout hole |
| ⑥ | | Bottom through hole : ø52 Knockout hole |
| ⑦ | For transmission cables | Front through hole : ø34 Knockout hole |
| ⑧ | | Bottom through hole : ø34 Knockout hole |

PUHY-P200, 250, 300YNW-A1 (-BS)

Unit: mm

1. Required space around the unit

● In case of single installation

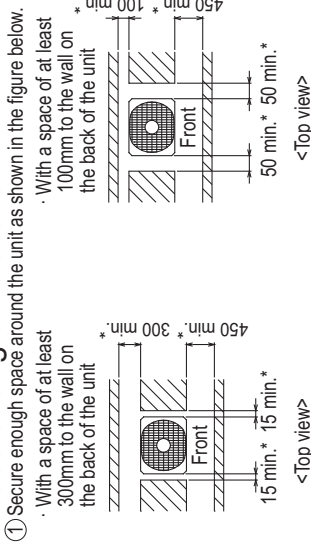

- Secure enough space around the unit as shown in the figure below.
 - With a space of at least 300mm to the wall on the back of the unit

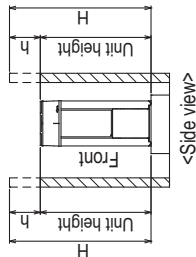

- When the height of the walls on the front, back or on the sides <H> exceeds the wall height limit as defined below add the height that exceeds the height limit <h> to the figures that are marked with an asterisk.
 - <Wall height limit> Front :Up to the unit height
 - Back :Up to the unit height
 - Side :Up to the unit height

2. Foundation work

- Take into consideration the surface strength, water drainage route, piping route, and wiring route when preparing the installation site.
 - <Note that the drain water comes out of the unit during operation.>
- Build the foundation in such way that the corner of the installation leg is securely supported as shown in the right figure. (Fig.A,B)
 - When using a rubber isolating cushion, please ensure it is large enough to cover the entire width of each of the unit's legs.
- The protrusion length of the anchor bolt must not exceed 30mm. (Fig.A,B)
- Use four fixing plates as shown in the right figure <field supply required> when using post-installed anchor bolts. (Fig.C,D)
- To prevent small animals and water and snow from entering the unit and damaging its parts, close the gap around the edges of through holes for pipes and wires with filler plates <field supply required>.
- When the pipes or cables are routed at the bottom of the unit, make sure that the through hole at the base of the unit does not get blocked with the installation base.
- Refer to the Installation Manual when installing units on an installation base.

● In case of collective installation

- When multiple units are installed adjacent to each other, secure enough space to allow for air circulation and walkway between groups of units as shown in the figures below.
 - At least two sides must be left open.
 - As with the single installation, add the height that exceeds the height limit <h> to the figures that are marked with an asterisk.
- If there is a wall at both the front and the rear of the unit, install up to six units consecutively in the side direction and provide a space of 1000mm or more as inlet space/ passage space for each six units.

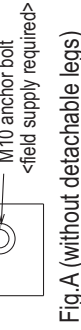
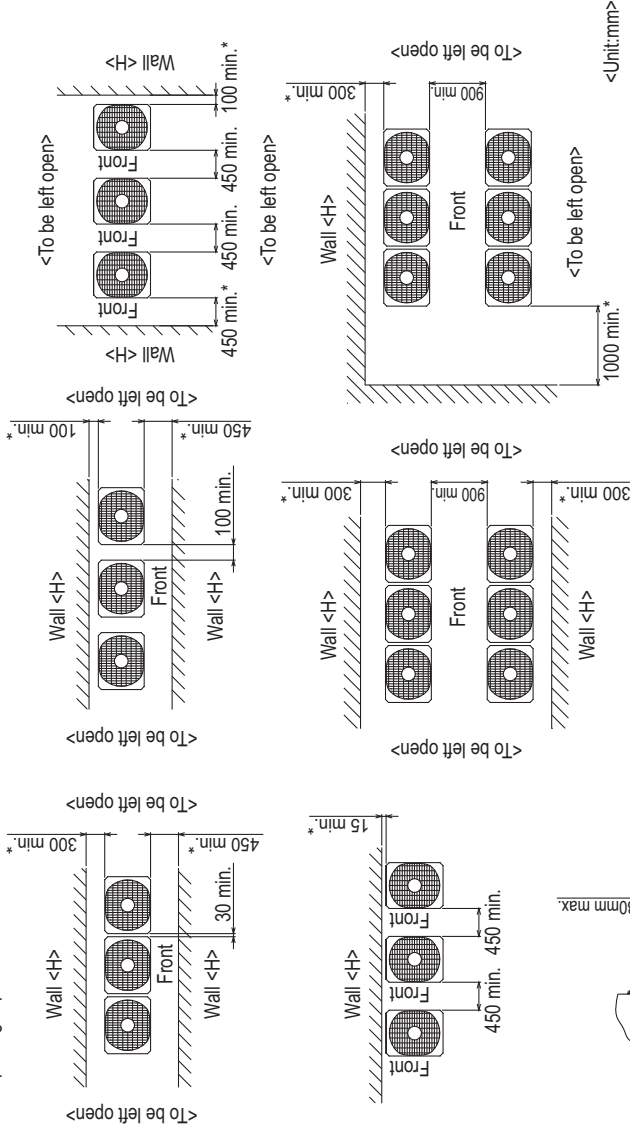

Fig.A (without detachable legs)

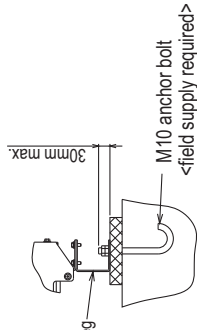

Fig.B (with detachable legs)



Fig.C (without detachable legs)

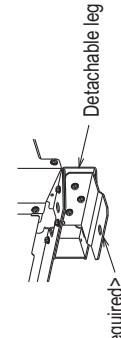

Fig.D (with detachable legs)

Unit: mm

PUHY-P350, 400, 450YNW-A1 (-BS)

Note 1. Please refer to the next page for information regarding necessary spacing around the unit and foundation work.

2. The detachable leg can be removed at site.

3. At brazing of pipes, wrap the refrigerant service valve with wet cloth and keep the temperature of refrigerant service valve under 120°C.

Connecting pipe specifications

| Model | Refrigerant pipe | | Diameter | |
|-------|------------------|---------------|----------|--------|
| | Liquid | Gas | Liquid | Gas |
| P350 | ø12.7 Brazed | | | |
| P400 | ø12.7 Brazed | ø28.58 Brazed | ø12.7 | ø28.58 |
| P450 | ø15.88 Brazed *1 | | | |

*1 Connect the refrigerant pipe to the service valve according to the Installation Manual.
 *2 Indicates dimensions and connection specifications in the case the unit is used in combination with other outdoor units. (Except for P650)

Top view

2xø4.6 Hole
(Make hole at the plastic fan guard for snow hood attachment)
<Snow hood attachment hole>

Front view

Intake air
Control box
Detachable leg (front and back, 2 points)
Note 2*

Left side view

Discharge air
Intake air
Service panel
Refrigerant service valve <liquid>
Refrigerant service valve <gas>

Bottom view

Refrigerant service valve <liquid>
Refrigerant service valve <gas>

Rear view

Intake air

Specifications

| NO. | Usage | Specifications |
|-----|---------------------|--------------------------|
| ① | Front through hole | 148 x 84 Knockout hole |
| ② | Bottom through hole | 150 x 94 Knockout hole |
| ③ | Front through hole | ø65 or ø40 Knockout hole |
| ④ | Front through hole | ø52 or ø27 Knockout hole |
| ⑤ | Bottom through hole | ø65 Knockout hole |
| ⑥ | Bottom through hole | ø52 Knockout hole |
| ⑦ | Front through hole | ø34 Knockout hole |
| ⑧ | Bottom through hole | ø34 Knockout hole |

PUHY-P350, 400, 450YNW-A1 (-BS)

Unit: mm

1. Required space around the unit

In case of single installation

- ① Secure enough space around the unit as shown in the figure below.

- With a space of at least 300mm to the wall on the back of the unit

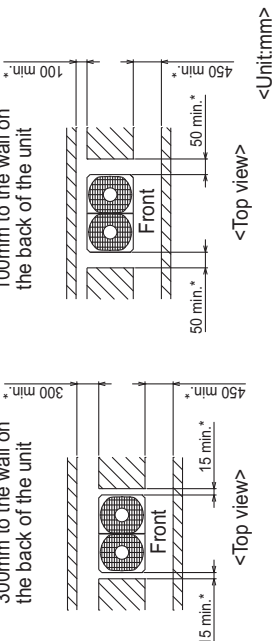

- ② When the height of the walls on the front, back or on the sides<H> exceeds the wall height limit as defined below add the height that exceeds the height limit <h> to the figures that are marked with an asterisk.

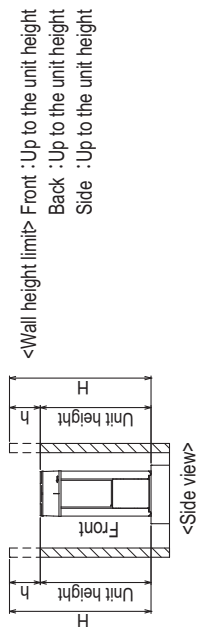

2. Foundation work

- ① Take into consideration the surface strength, water drainage route, piping route, and wiring route when preparing the installation site. <Note that the drain water comes out of the unit during operation.>
- ② Build the foundation in such way that the corner of the installation leg is securely supported as shown in the right figure.(Fig.A,B) When using a rubber isolating cushion, please ensure it is large enough to cover the entire width of each of the unit's legs.
- ③ The protrusion length of the anchor bolt must not exceed 30mm.(Fig.A,B)
- ④ Use four fixing plates as shown in the right figure <field supply required> when using post-installed anchor bolts (Fig.C,D)
- ⑤ To prevent small animals and water and snow from entering the unit and damaging its parts, close the gap around the edges of through holes for pipes and wires with filler plates <field supply required>.
- ⑥ When the pipes or cables are routed at the bottom of the unit, make sure that the through hole at the base of the unit does not get blocked with the installation base.
- ⑦ Refer to the Installation Manual when installing units on an installation base.

In case of collective installation

- ① When multiple units are installed adjacent to each other, secure enough space to allow for air circulation and walkway between groups of units as shown in the figures below.
- ② At least two sides must be left open.
- ③ As with the single installation, add the height that exceeds the height limit<h> to the figures that are marked with an asterisk.
- ④ If there is a wall at both the front and the rear of the unit, install up to six units consecutively in the side direction and provide a space of 1000mm or more as inlet space/ passage space for each six units.

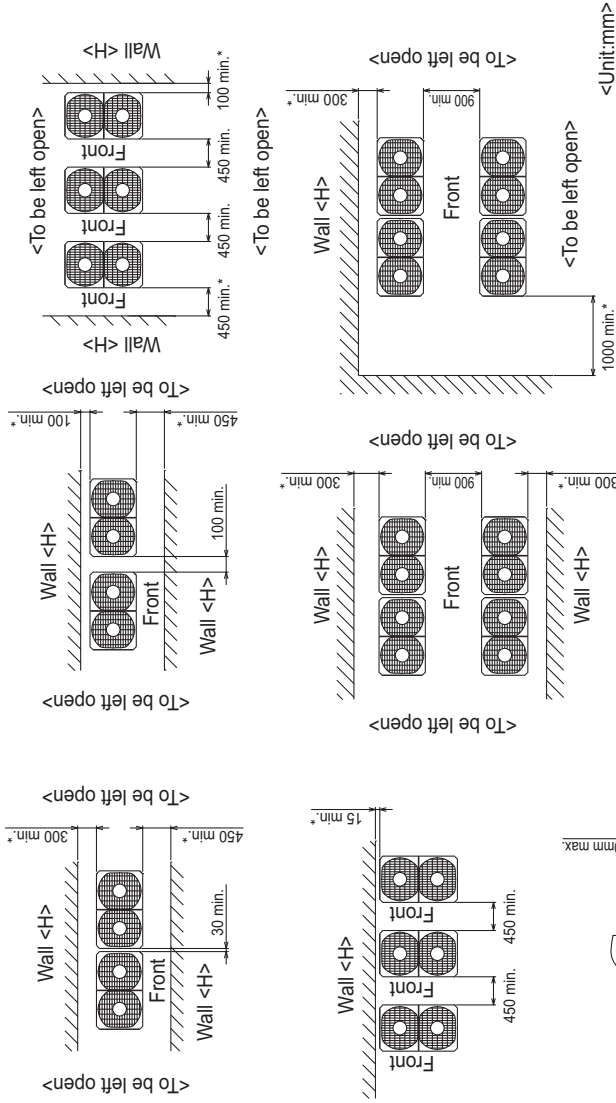

Fig.A (without detachable legs)

Fig.C (without detachable legs)

Fig.D (with detachable legs)

Fig.B (with detachable legs)

Fig.E (with detachable legs)

M10 anchor bolt <field supply required>

Fixing plate <field supply required>

Detachable leg

Fixing plate <field supply required>

Detachable leg

PUHY-P500YNW-A1 (-BS)

Unit: mm

● In case of collective installation

- ① When multiple units are installed adjacent to each other, secure enough space to allow for air circulation and walkway between groups of units as shown in the figures below.
- ② At least two sides must be left open.
- ③ As with the single installation, add the height that exceeds the height limit <h> to the figures that are marked with an asterisk.
- ④ If there is a wall at both the front and the rear of the unit, install up to three units consecutively in the side direction and provide a space of 1000mm or more as inlet space/ passage space for each three units.

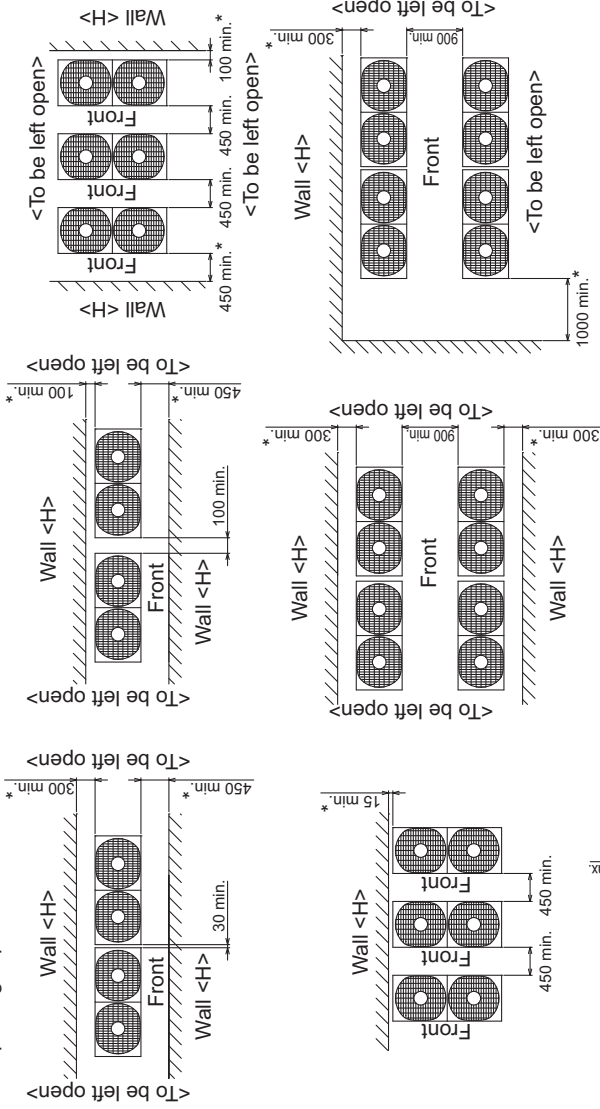

<Unit:mm>

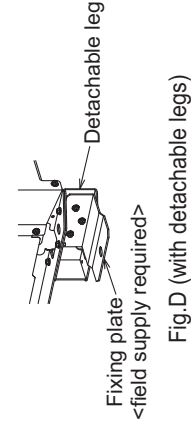

Fig.D (with detachable legs)

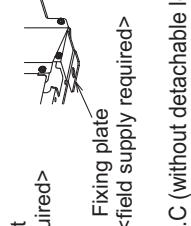
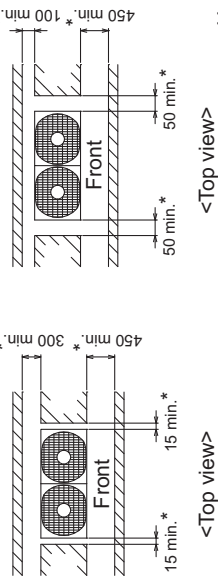

Fig.C (without detachable legs)

1. Required space around the unit

● In case of single installation

- ① Secure enough space around the unit as shown in the figure below.
 - With a space of at least 100mm to the wall on the back of the unit



<Unit:mm>

- ② When the height of the walls on the front, back or on the sides <H> exceeds the wall height limit as defined below add the height that exceeds the height limit <h> to the figures that are marked with an asterisk.

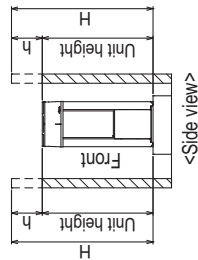

<Wall height limit> Front :Up to the unit height
Back :Up to the unit height
Side :Up to the unit height

2.Foundation work

- ① Take into consideration the surface strength, water drainage route, piping route, and wiring route when preparing the installation site.
 - <Note that the drain water comes out of the unit during operation.>
- ② Build the foundation in such way that the corner of the installation leg is securely supported as shown in the right figure.(Fig.A,B)
When using a rubber isolating cushion, please ensure it is large enough to cover the entire width of each of the unit's legs.
- ③ The protrusion length of the anchor bolt must not exceed 30mm.(Fig.A,B)
- ④ Use six fixing plates as shown in the right figure <field supply required> when using post-installed anchor bolts.(Fig.C,D)
- ⑤ To prevent small animals and water and snow from entering the unit and damaging its parts, close the gap around the edges of through holes for pipes and wires with filler plates <field supply required>.
- ⑥ When the pipes or cables are routed at the bottom of the unit, make sure that the through hole at the base of the unit does not get blocked with the installation base.
- ⑦ Refer to the Installation Manual when installing units on an installation base.

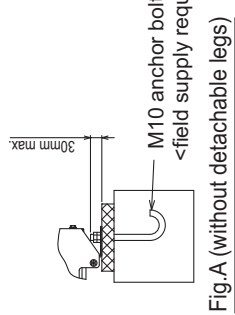

Fig.A (without detachable legs)

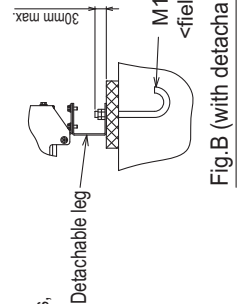
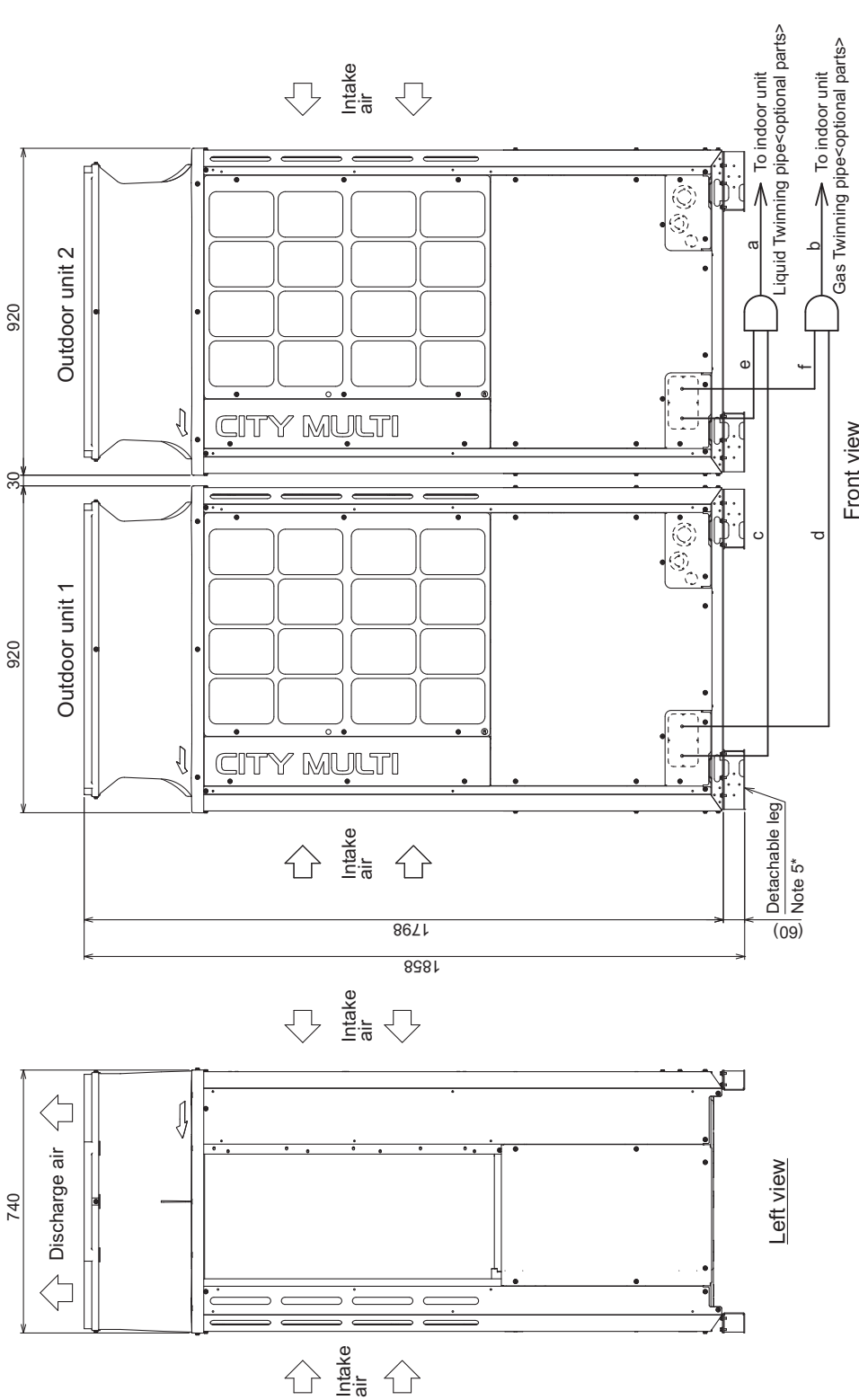

Fig.B (with detachable legs)

PUHY-P400, 450, 500, 550, 600YSNW-A1 (-BS)

Unit: mm



Twinning pipe connection size

| Package unit name | PUHY-P400YSNW-A1(-BS) PUHY-P450YSNW-A1(-BS) PUHY-P500YSNW-A1(-BS) PUHY-P550YSNW-A1(-BS) PUHY-P600YSNW-A1(-BS) | |
|--------------------------------------|-----------------------------------------------------------------------------------------------------------------------|--------|
| Outdoor unit 1 | PUHY-P200YSNW-A1(-BS) PUHY-P250YSNW-A1(-BS) PUHY-P300YSNW-A1(-BS) | |
| Outdoor unit 2 | PUHY-P200YSNW-A1(-BS) PUHY-P250YSNW-A1(-BS) PUHY-P300YSNW-A1(-BS) | |
| Outdoor Twinning Kit(optional parts) | CMY-Y100VBK3 | |
| Indoor unit-Twinning pipe | Liquid | ø12.7 |
| | Gas | ø28.58 |

| Twinning pipe-Outdoor unit | Unit model | Gas | |
|----------------------------|------------|--------|--------|
| | | c or e | d or f |
| P200 | P250 | ø9.52 | ø22.2 |
| | | ø9.52 | ø22.2 |
| P300 | P300 | ø12.7 | ø22.2 |
| | | ø12.7 | ø22.2 |

- Note 1. Connect the pipes as shown in the figure above. Refer to the table above for the pipe size.
- Note 2. Twinning pipes should not be tilted more than 15 degrees from the horizontal plane. Be sure to see the Installation Manual for details of Twinning pipe installation.
- Note 3. The pipe section before the Twinning pipe (sections "a" and "b" in the figure) must have at least 500mm of straight section (*including the straight pipe that is supplied with the Twinning pipe).
- Note 4. Only use the Twinning pipe by Mitsubishi (optional parts).
- Note 5. The detachable leg can be removed at site.

PUHY-P650YSNW-A1 (-BS)

Unit: mm

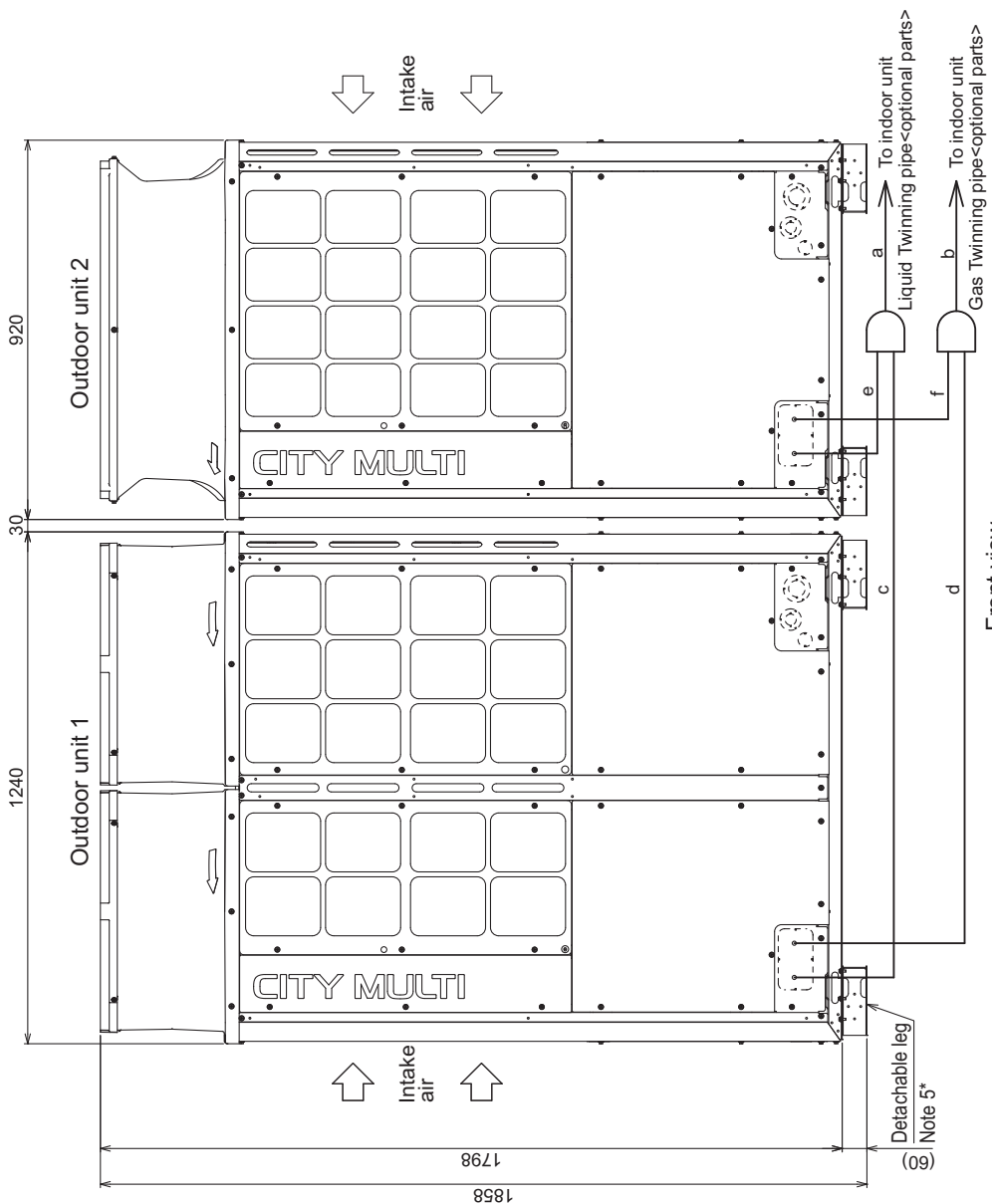

Front view

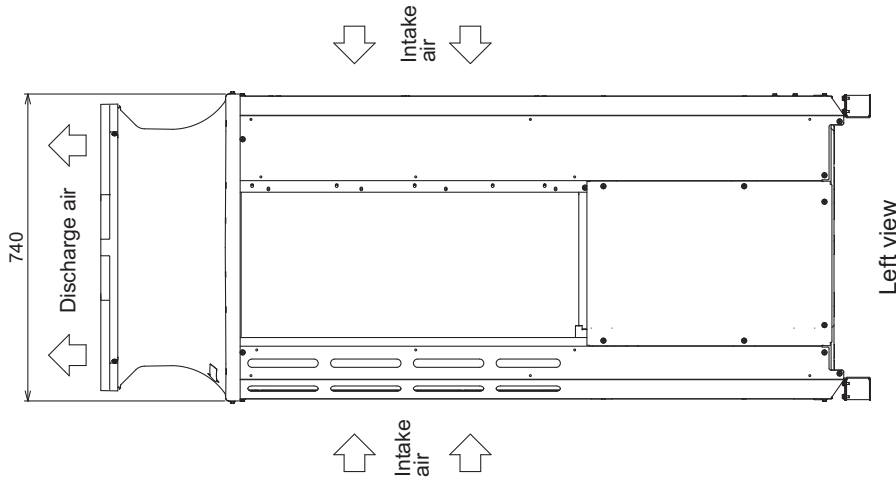

Left view

Twinning pipe connection size

| Package unit name | PUHY-P650YSNW-A1(-BS) |
|--------------------------------------|-----------------------|
| Outdoor unit 1 | PUHY-P400YNW-A1(-BS) |
| Outdoor unit 2 | PUHY-P250YNW-A1(-BS) |
| Outdoor Twinning Kit(optional parts) | CMY-Y100VBK3 |
| Indoor unit-Twinning pipe | |
| Liquid | a |
| Gas | b |
| | ø15.88 |
| | ø28.58 |

| Unit model | Liquid core | Gas |
|------------|-------------|--------|
| P250 | ø9.52 | ø22.2 |
| P400 | ø12.7 | ø28.58 |

- Note 1. Connect the pipes as shown in the figure above. Refer to the table above for the pipe size.
 2. Twinning pipes should not be tilted more than 15 degrees from the horizontal plane.
 Be sure to see the Installation Manual for details of Twinning pipe installation.
 3. The pipe section before the Twinning pipe (sections "a" and "b" in the figure) must have at least 500mm of straight section (*including the straight pipe that is supplied with the Twinning pipe).
 4. Only use the Twinning pipe by Mitsubishi (optional parts).
 5. The detachable leg can be removed at site.

PUHY-P950, 1000, 1050YSNW-A1 (-BS)

Unit: mm

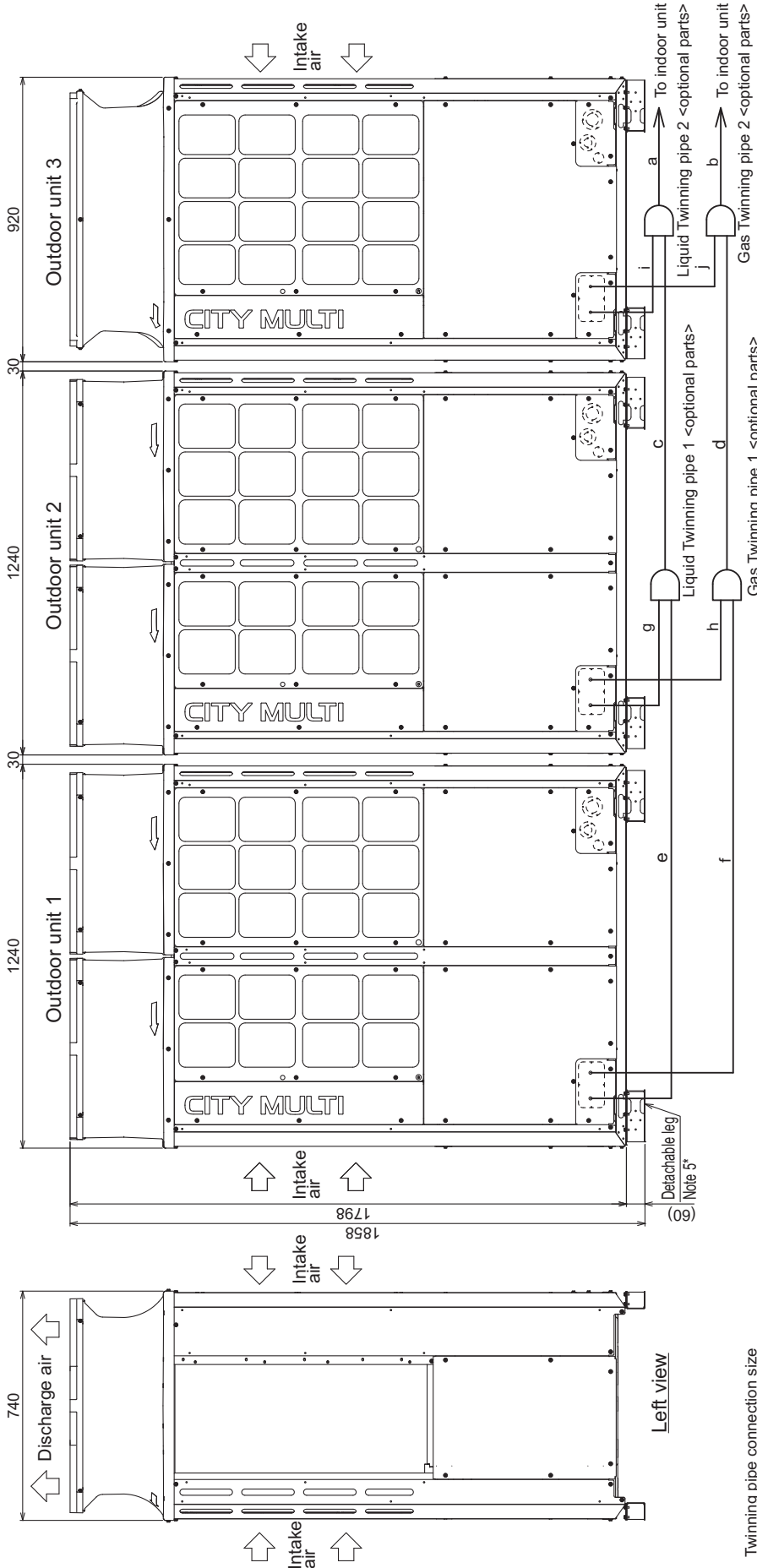

Front view

| Twinning pipe connection size | | PUHY-P950YSNW-A1(-BS) | PUHY-P1000YSNW-A1(-BS) | PUHY-P1050YSNW-A1(-BS) |
|--------------------------------------|----------------|-----------------------|------------------------|------------------------|
| Package unit name | Outdoor unit 1 | PUHY-P350YNW-A1(-BS) | PUHY-P400YNW-A1(-BS) | PUHY-P400YNW-A1(-BS) |
| Component unit name | Outdoor unit 2 | PUHY-P350YNW-A1(-BS) | PUHY-P350YNW-A1(-BS) | PUHY-P400YNW-A1(-BS) |
| Outdoor Twinning Kit(optional parts) | Outdoor unit 3 | PUHY-P250YNW-A1(-BS) | PUHY-P250YNW-A1(-BS) | PUHY-P250YNW-A1(-BS) |
| Indoor unit~Twinning pipe 2 | Liquid | CMY-Y300VVK3 | | |
| | Gas | ø19.05 | | |
| Twinning pipe 1~Twinning pipe 2 | Liquid | ø41.28 | | |
| | Gas | ø19.05 | | |
| | | ø34.93 | | |

| Unit model | Liquid e or g or i | Gas for h or j |
|------------|--------------------|----------------|
| P250 | ø9.52 | ø22.2 |
| P350 | ø12.7 | ø28.58 |
| P400 | ø15.88 | ø28.58 |

- Note 1. Connect the pipes as shown in the figure above. Refer to the table above for the pipe size.
 2. Twinning pipes should not be tilted more than 15 degrees from the horizontal plane.
 Be sure to see the Installation Manual for details of Twinning pipe installation.
 3. The pipe section before the Twinning pipe (sections "a", "b", "c" and "d" in the figure) must have at least 500mm of straight section (*including the straight pipe that is supplied with the Twinning pipe).
 4. Only use the Twinning pipe by Mitsubishi (optional parts).
 5. The detachable leg can be removed at site.

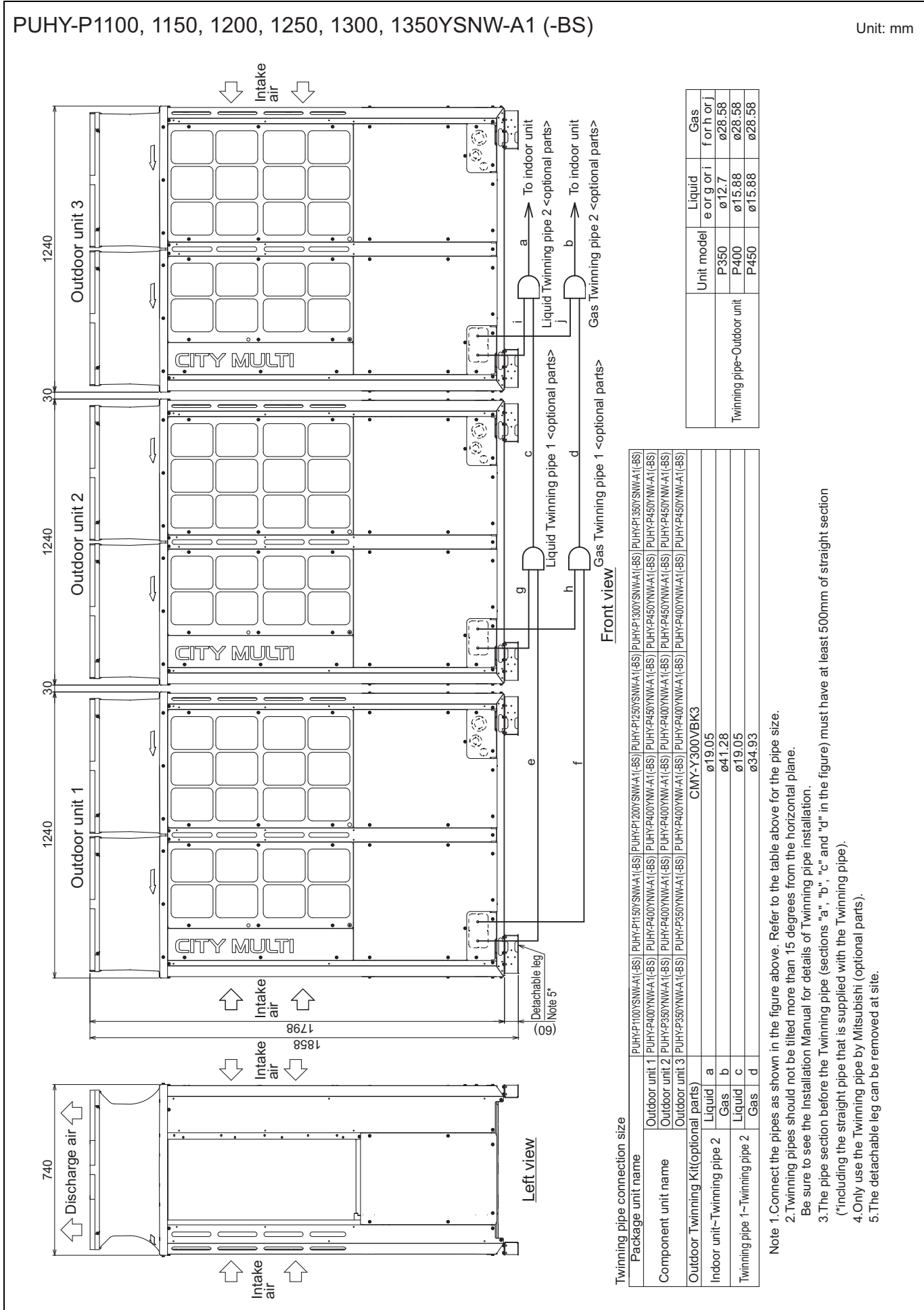

PUHY-P-Y(S)NW-A1

PUHY-P-Y(S)NW-A1

PUHY-P200, 250, 300YNW-A1 (-BS)

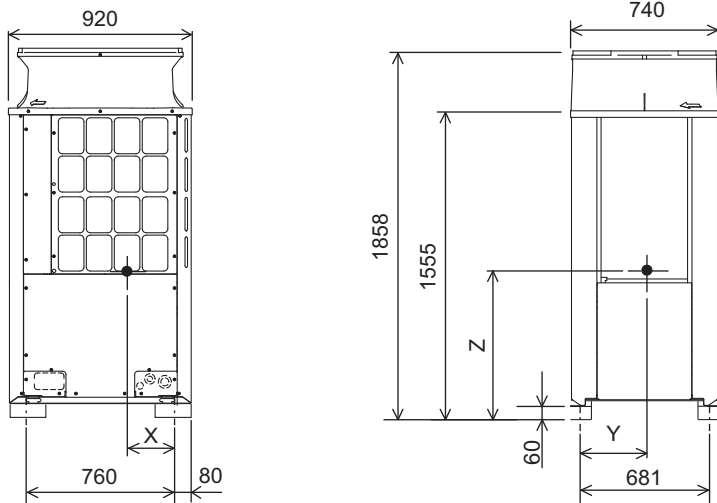

Unit: mm

| Model | X | Y | Z |
|----------------------|-----|-----|-----|
| PUHY-P200YNW-A1(-BS) | 342 | 343 | 684 |
| PUHY-P250YNW-A1(-BS) | 342 | 343 | 684 |
| PUHY-P300YNW-A1(-BS) | 350 | 338 | 686 |

PUHY-P350, 400, 450YNW-A1 (-BS)

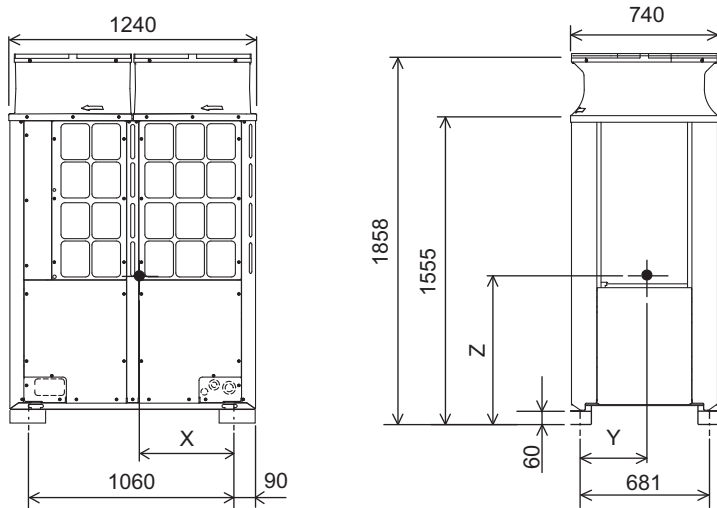

Unit: mm

| Model | X | Y | Z |
|----------------------|-----|-----|-----|
| PUHY-P350YNW-A1(-BS) | 489 | 340 | 732 |
| PUHY-P400YNW-A1(-BS) | 489 | 340 | 732 |
| PUHY-P450YNW-A1(-BS) | 491 | 347 | 750 |

PUHY-P500YNW-A1 (-BS)

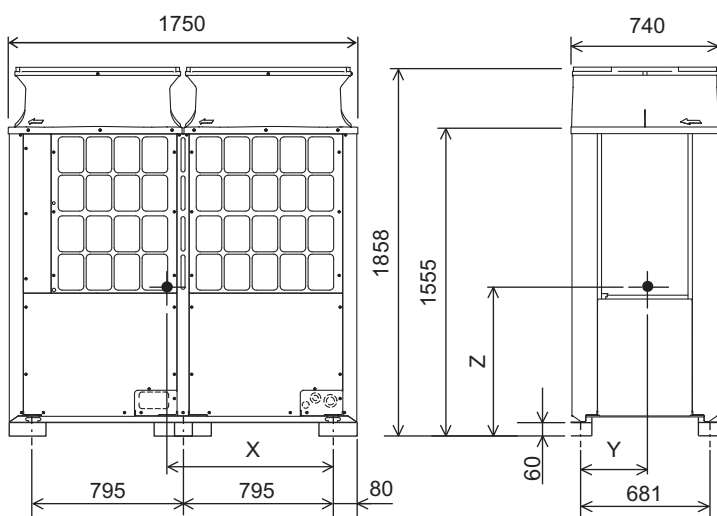

Unit: mm

| Model | X | Y | Z |
|----------------------|-----|-----|-----|
| PUHY-P500YNW-A1(-BS) | 857 | 311 | 723 |

PUHY-P200, 250, 300YNW-A1 (-BS)

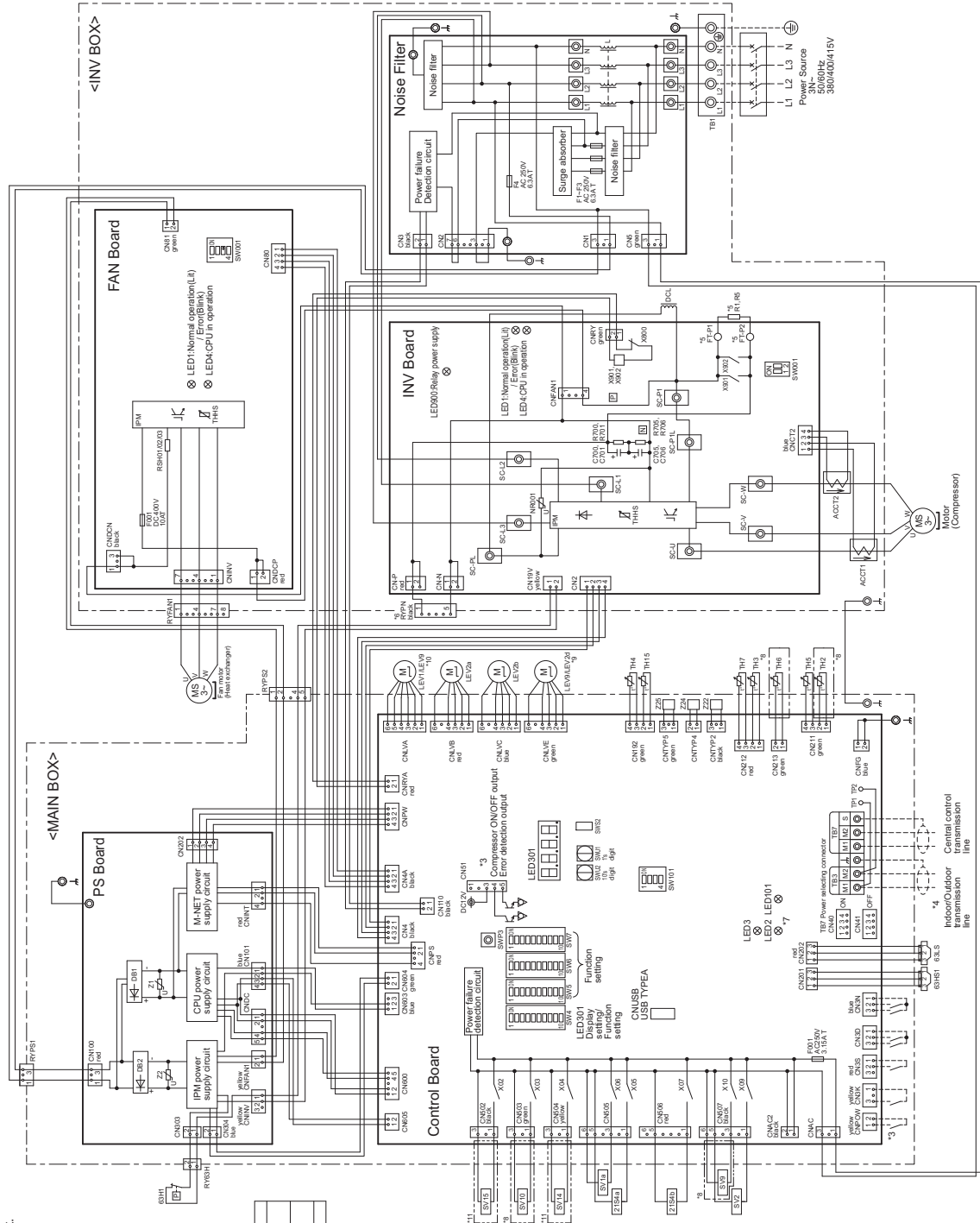

- *1 Single-dotted lines indicate wiring not supplied with the unit.
- *2 Dot-dash lines indicate the control box boundaries.
- *3 Refer to the Data book for connecting input/output signal connectors.
- *4 Daisy-chain terminals (TB3) on the outdoor units in the same refrigerant system together.
- *5 Faston terminals have a locking function. Make sure the terminals are securely locked in place after insertion. Press the tab on the terminals to removed them.
- *6 Control box houses high-voltage parts. Before inspecting the inside of the MAIN BOX or INV BOX, turn off the power, keep the unit off for at least 10 minutes, and confirm that the voltage of the connector RYPN on INV BOX has dropped to DC20V or less.
- *7 Control board LED display.

| | |
|--------|--------------------------------------------------------------------|
| LED3 | Normal operation (L)/Error (Blank) |
| LED3 | SW6-10 is OFF and In operation (L)/In stop (Unit) |
| | SW4-1-10 are OFF Function setting by SW4 enable (L)/Disable (Unit) |
| LED101 | Normal operation (L)/C Error (Unit) |

*8 Difference of appliance.

| | |
|------------|------------------|
| Model name | Appliance |
| PUHY | *8 do not exist. |

*9 Difference of appliance.

| | |
|------------|-----------|
| Model name | Appliance |
| PUHY | LEV9 |
| PUHY | LEV2d |

*10 Difference of appliance.

| | |
|------------|-----------|
| Model name | Appliance |
| PUHY | LEV1 |
| PUHY | LEV9 |

*11 Difference of appliances.

| | |
|------------|-------------------|
| Model name | Appliance |
| PUHY/PUY | *11 do not exist. |
| PUHY/EP | *11 exist. |

<Symbol explanation>

| Symbol | Explanation |
|-------------|----------------------------------------------------------|
| Z194a | Cooling/Heating switching |
| Z194b | Heat exchanger capacity control (only PUHY) |
| 6B11 | High pressure protection for the outdoor unit |
| 6B1S1 | Pressure sensor |
| 6E1S | Low pressure sensor |
| ACCT/ACCTZ | Capacitor (inverter main circuit) |
| CN0701 | DC reactor |
| CN05/02/06 | Choke coil (for high frequency noise reduction) |
| DCL | Linear expansion valve |
| LEV1*10 | HIC bypass. Controls refrigerant flow in HIC circuit. |
| LEV2a,b | Pressure control/Refrigerant flow rate control |
| LEV2*9 | Pressure control/Refrigerant flow rate control |
| LEV9*10 | Heat exchanger for inverter |
| R15 | For inrush current prevention |
| RS1D/102/03 | For opening/closing the bypass circuit under the OS |
| SV1a | For opening/closing the discharge (cooling/heating) |
| SV2 | For opening/closing the bypass circuit (cooling/heating) |
| SV3 | For opening/closing the bypass circuit (cooling/heating) |
| SV4/15*11 | For opening/closing the bypass circuit (cooling/heating) |
| TB1 | Terminal block |
| TB3 | Indoor/Outdoor transmission line |
| TB7 | Central control transmission line |
| TH2*8 | Subcool bypass outlet temperature |
| TH3 | High temperature |
| TH4 | Discharge pipe temperature |
| TH5 | ACG inlet pipe temperature |
| TH6*8 | Subcooled liquid refrigerant temperature |
| TH7 | OA temperature |
| TH15 | Compressor shell bottom temperature |
| THS | IPM temperature |
| X07/302 | Magnetic relay (inverter main circuit) |
| ZZ1/2/1,2,5 | Function setting connector |

PUHY-P350, 400, 450Y(N)W-A1 (-BS)

PUHY-P-Y(S)NW-A1

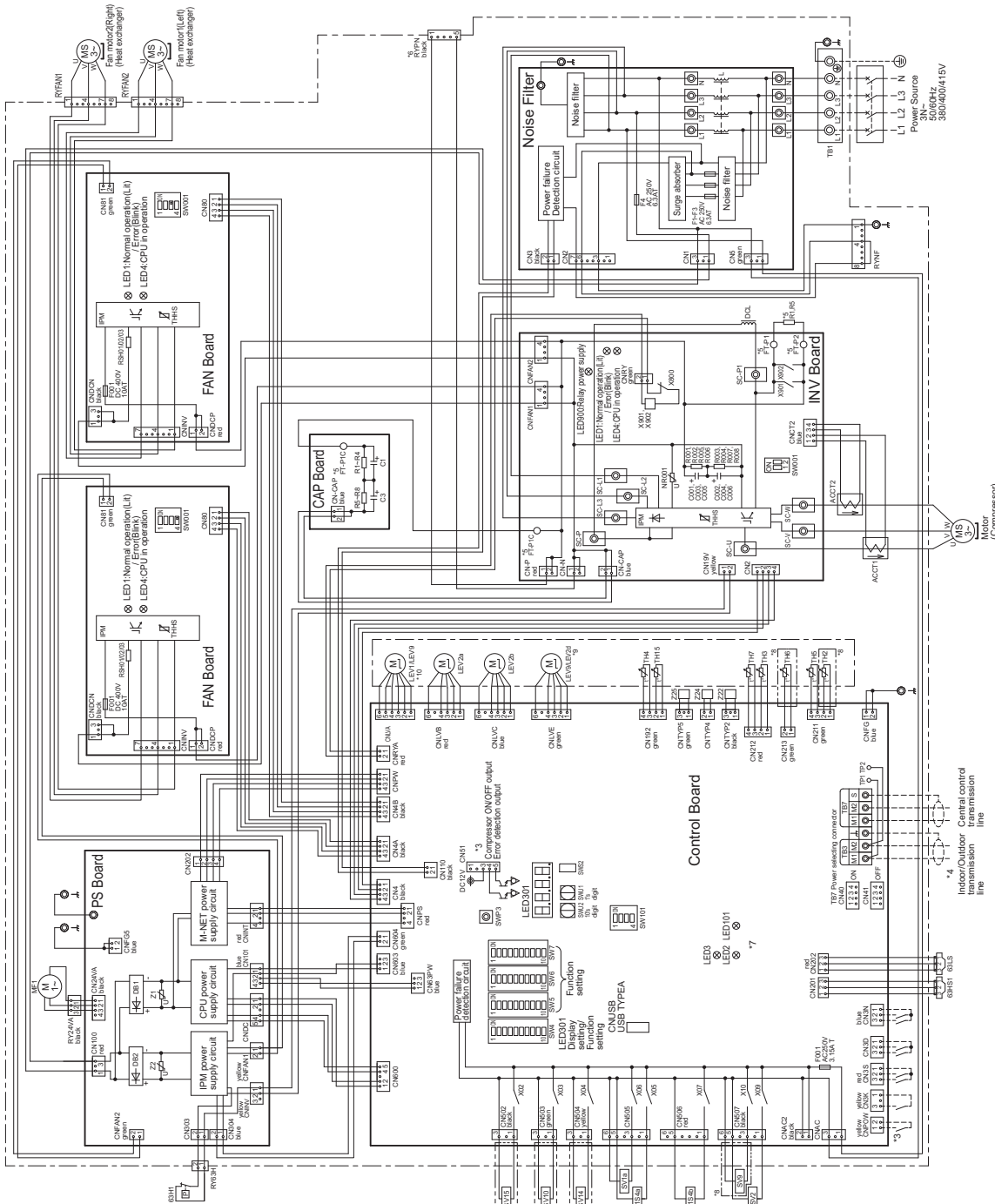

- *1. Single-dotted lines indicate wiring not supplied with the unit.
- *2. Dot-dash lines indicate the control box boundaries.
- *3. Refer to the Data book for connecting input/output signal connectors.
- *4. Daisy-chain terminals (TB3) on the outdoor units in the same refrigerant system together.
- *5. Faston terminals have a locking function.
- *6. Make sure the terminals are securely locked in place after insertion. Press the tab on the terminals to removed them.
- *6 Control box houses high-voltage parts
- Before inspecting the inside of the control box, turn off the power, keep the unit off for at least 10 minutes, and confirm that the voltage of the connector RYPN has dropped to DC20V or less.
- *7. Control board LED display.

| | |
|--------|-----------------------------------------------------|
| LED2 | Normal operation (LED/Blank) |
| LED3 | SW6: 10 is OFF and in operation (L/L in step/Unit) |
| | SW4-1-10 are OFF |
| | SW6-10 is ON |
| LED101 | Normal operation (LED/Blank) |
| | Function setting by SW4 standard (L/L/issable/Unit) |

***8. Difference of appliance.**

| Model name / Appliance | Appliance |
|------------------------|-----------|
| PUHY/PUY | *8 exist |
| PUHY/EP | *11 exist |

***9. Difference of appliance.**

| Model name / Appliance | Appliance |
|------------------------|-----------|
| PUHY | LEV9 |
| PUY | LEV2Z |

***10. Difference of appliance.**

| Model name / Appliance | Appliance |
|------------------------|-----------|
| PUHY | LEV1 |
| PUY | LEV9 |

<Symbol explanation>

| Symbol | Explanation |
|-------------|------------------------------------------------------|
| Z1/S1b | Cooling/Heating switching |
| Z1/S1b | Compressor capacity control (only PUHY model) |
| 68H1 | High pressure protection for the outdoor unit |
| 68H1 | Discharge pressure |
| 68L1/ACCT2 | Low pressure |
| C001-C006 | Current sensor (AC) |
| DC | DC reactor |
| L | Check coil (for high frequency noise reduction) |
| LEV1*10 | HIC bypass. Controls refrigerant flow in HIC circuit |
| LEV2a.b | Pressure control/Refrigerant flow rate control |
| LEV2d*9 | Pressure control/Refrigerant flow rate control |
| LEV9*9/10 | Heat exchanger for inverter |
| RF1 | Fan motor (for cooling in control box) |
| RSR01/02/03 | Resistor |
| SV1/8 | For inrush current prevention |
| SV2 | Solenoid valve |
| SV9*8 | For opening/closing the discharge action bypass |
| SV10*8 | For opening/closing the discharge action bypass |
| SV14.15*11 | For continuous heating (cooling/heating) |
| TB1 | Power supply |
| TB3 | Terminal block |
| TB5 | Indoor/Outdoor transmission line |
| TB7 | Central control transmission line |
| TH4 | Subcool bypass outlet temperature |
| TH5 | Discharge pipe temperature |
| TH6*8 | ACC inlet pipe temperature |
| TH7 | Subcooled liquid refrigerant temperature |
| TH15 | OA temperature |
| TH15 | Compressor shell bottom temperature |
| TH15 | IPM temperature |
| X001.X002 | Magnetic relay (inverter main circuit) |
| Z2Z.A.25 | Function setting connector |

PUHY-P500YNW-A1 (-BS)

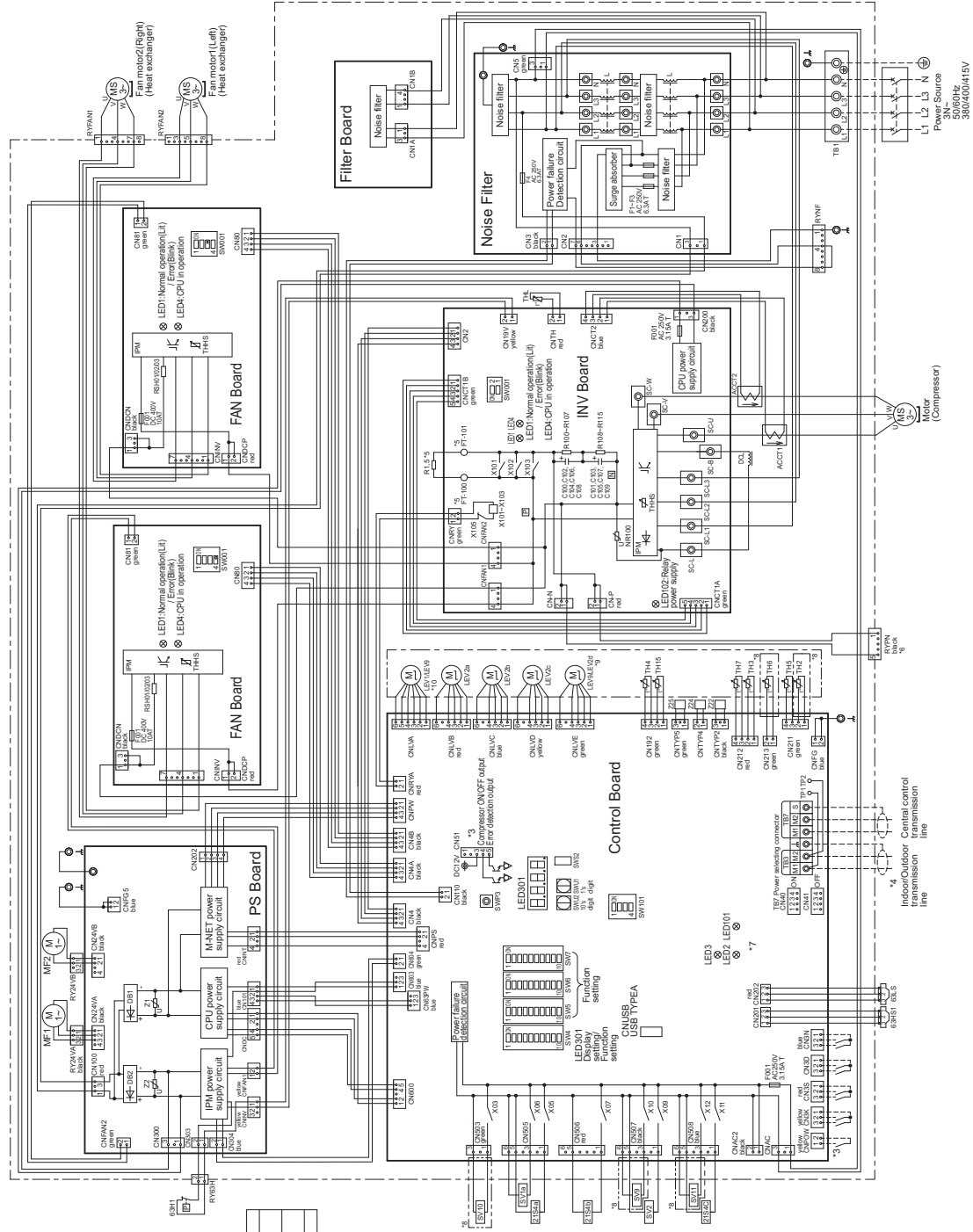

- *1. Single-dotted lines indicate wiring not supplied with the unit.
- *2. Dot-dash lines indicate the control box boundaries.
- *3. Refer to the Data book for connecting input/output signal connectors.
- *4. Daisy-chain terminals (TB3) on the outdoor units in the same refrigerant system together.
- *5. Faston terminals have a locking function. Make sure the terminals are securely locked in place after insertion. Press the tab on the terminals to removed them.
- *6. Control box houses high-voltage parts. Before inspecting the inside of the control box, turn off the power, keep the unit off for at least 10 minutes, and confirm that the voltage of the connector RYPN has dropped to DC20V or less.
- *7. Control board LED display.

| | |
|--------|-------------------------------------------------|
| LED2 | Normal operation(L)/Error(Blank) |
| LED3 | SW6-10 is OFF and In operation(L)/In stop(Unit) |
| LED4 | SW4-10 are ON |
| LED5 | Function setting by SW4 and SW5 (Unit) |
| LED101 | Normal operation(L)/VC Error(Unit) |

*8. Difference of appliance.

| | |
|------------|----------------|
| Model name | Appliance |
| PUHY | 4 do not exist |
| PUY | 4 do not exist |

*9. Difference of appliance.

| | |
|------------|-----------|
| Model name | Appliance |
| PUHY | LEV0 |
| PUY | LEV2d |

*10. Difference of appliance.

| | |
|------------|-----------|
| Model name | Appliance |
| PUHY | LEV0 |
| PUY | LEV9 |

<Symbol explanation>

| Symbol | Explanation |
|----------------|------------------------------------------------------|
| 21S4a | 4-way valve |
| 21S4b.c | Cooling/heating capacity control(only PUHY mode) |
| 63H1 | Pressure switch |
| 63H5 | Pressure sensor |
| 63LS | Discharge pressure |
| ACCT1,ACCT2 | Current sensor(AC) |
| C100-C109 | Capacitor (inverter main circuit) |
| DC | DC reactor |
| LEV1 *10 | Choke coil (for high frequency noise reduction) |
| LEV2a,b,c | H/C bypass,Controls refrigerant flow in H/C circuit |
| LEV2d *9 | Pressure control,Refrigerant flow rate control |
| LEV9 *10 | Pressure control,Refrigerant flow rate control |
| MFL2 | Heat exchanger for inverter |
| RT1.5 | Fan motor(for cooling in control box) |
| RSR01/02/03 | Resistor |
| SV1a | For current detection |
| SV1b | For opening/closing the bypass circuit under the O/S |
| SV2 | For opening/closing the discharge suction bypass |
| SV9 *8 | For opening/closing the bypass circuit |
| SV10,11 *8 | For continuous heating |
| Terminal block | Power supply |
| TB1 | Micro/Outdoor transmission line |
| TB3 | Micro/Outdoor transmission line |
| TB2 *8 | Subcooler inlet temperature |
| TH3 | Pipe temperature |
| TH4 | Discharge pipe temperature |
| TH5 | ACC inlet pipe temperature |
| TH6 *8 | Subcooled liquid refrigerant temperature |
| TH7 | O/A temperature |
| TH5 | Compressor shell bottom temperature |
| THS | IPM temperature |
| X101-X103 | Magnetic relay(inverter main circuit) |
| Z2Zd,25 | Function setting connector |

5-1. Sound levels in cooling mode

PUHY-P-Y(S)NW-A1

Measurement condition
PUHY-P200, 250, 300YNW-A1(-BS)

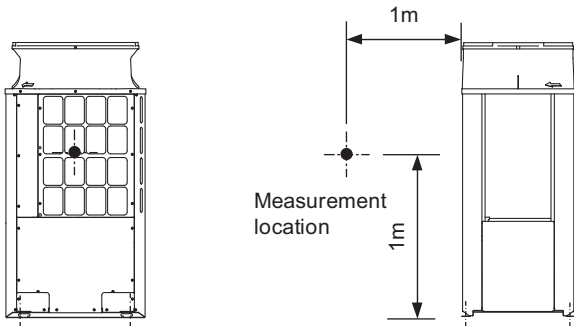

Sound level of PUHY-P300YNW-A1(-BS)

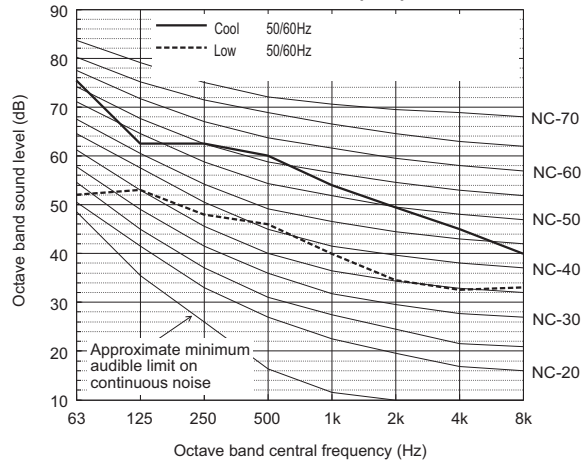

| | | 63 | 125 | 250 | 500 | 1k | 2k | 4k | 8k | dB(A) |
|------------------|---------|------|------|------|------|------|------|------|------|-------|
| Standard Cooling | 50/60Hz | 75.5 | 62.5 | 62.5 | 60.0 | 54.0 | 49.5 | 45.0 | 40.0 | 61.0 |
| Low noise mode | 50/60Hz | 52.0 | 53.0 | 48.0 | 46.0 | 40.0 | 34.5 | 32.5 | 33.0 | 47.0 |

When Low noise mode is set, the A/C system's capacity is limited. The system could return to normal operation from Low noise mode automatically in the case that the operation condition is severe.

Sound level of PUHY-P200YNW-A1(-BS)

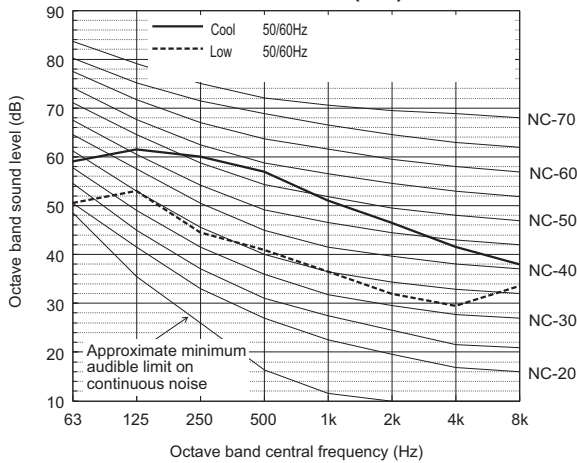

| | | 63 | 125 | 250 | 500 | 1k | 2k | 4k | 8k | dB(A) |
|------------------|---------|------|------|------|------|------|------|------|------|-------|
| Standard Cooling | 50/60Hz | 59.0 | 61.5 | 60.0 | 57.0 | 51.0 | 46.5 | 41.5 | 38.0 | 58.0 |
| Low noise mode | 50/60Hz | 50.5 | 53.0 | 44.5 | 41.0 | 36.5 | 32.0 | 29.5 | 33.5 | 44.0 |

When Low noise mode is set, the A/C system's capacity is limited. The system could return to normal operation from Low noise mode automatically in the case that the operation condition is severe.

Sound level of PUHY-P250YNW-A1(-BS)

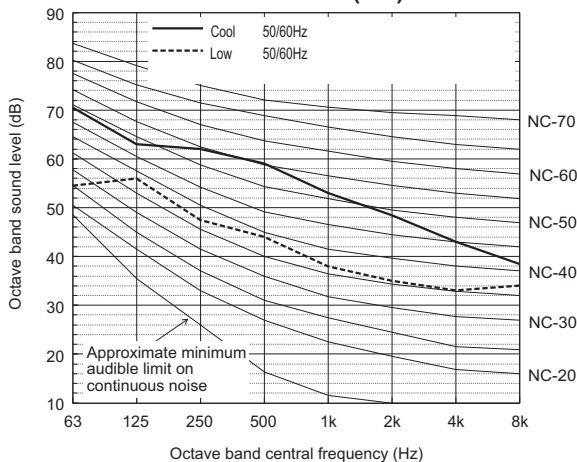

| | | 63 | 125 | 250 | 500 | 1k | 2k | 4k | 8k | dB(A) |
|------------------|---------|------|------|------|------|------|------|------|------|-------|
| Standard Cooling | 50/60Hz | 70.5 | 63.0 | 62.0 | 59.0 | 53.0 | 48.5 | 43.0 | 38.5 | 60.0 |
| Low noise mode | 50/60Hz | 54.5 | 56.0 | 47.5 | 44.0 | 38.0 | 35.0 | 33.0 | 34.0 | 46.5 |

When Low noise mode is set, the A/C system's capacity is limited. The system could return to normal operation from Low noise mode automatically in the case that the operation condition is severe.

• Depending on the operation conditions, the unit generates noise caused by valve actuation, refrigerant flow, and pressure changes when operating normally. Please consider to avoid location where quietness is required. The sound pressure level measured by the conventional method in JIS for reference purpose.

Measurement condition
PUHY-P350, 400, 450YNW-A1(-BS)

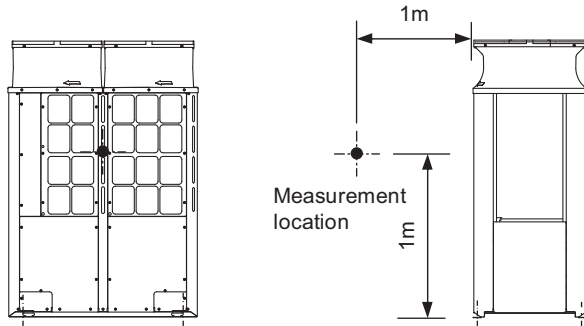

Sound level of PUHY-P450YNW-A1(-BS)

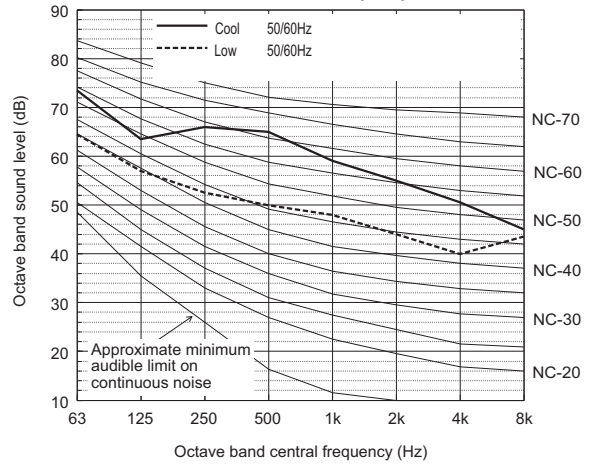

| | | 63 | 125 | 250 | 500 | 1k | 2k | 4k | 8k | dB(A) |
|------------------|---------|------|------|------|------|------|------|------|------|-------|
| Standard Cooling | 50/60Hz | 73.5 | 63.5 | 66.0 | 65.0 | 59.0 | 55.0 | 50.5 | 45.0 | 65.5 |
| Low noise mode | 50/60Hz | 64.5 | 57.0 | 52.5 | 50.0 | 48.0 | 44.0 | 40.0 | 43.5 | 53.5 |

When Low noise mode is set, the A/C system's capacity is limited. The system could return to normal operation from Low noise mode automatically in the case that the operation condition is severe.

Sound level of PUHY-P350YNW-A1(-BS)

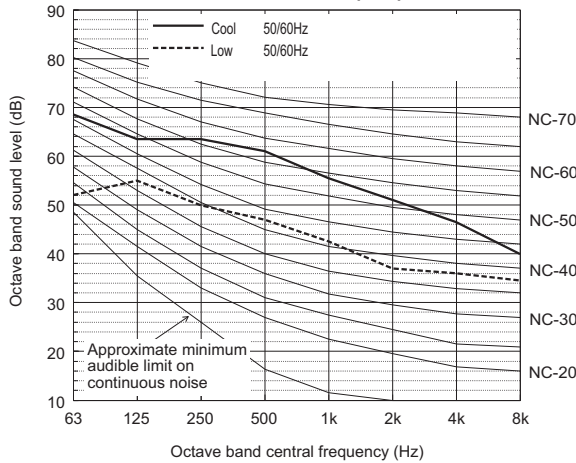

| | | 63 | 125 | 250 | 500 | 1k | 2k | 4k | 8k | dB(A) |
|------------------|---------|------|------|------|------|------|------|------|------|-------|
| Standard Cooling | 50/60Hz | 68.5 | 63.5 | 63.5 | 61.0 | 55.5 | 51.0 | 46.5 | 40.0 | 62.0 |
| Low noise mode | 50/60Hz | 52.0 | 55.0 | 50.0 | 47.0 | 42.5 | 37.0 | 36.0 | 34.5 | 49.0 |

When Low noise mode is set, the A/C system's capacity is limited. The system could return to normal operation from Low noise mode automatically in the case that the operation condition is severe.

Sound level of PUHY-P400YNW-A1(-BS)

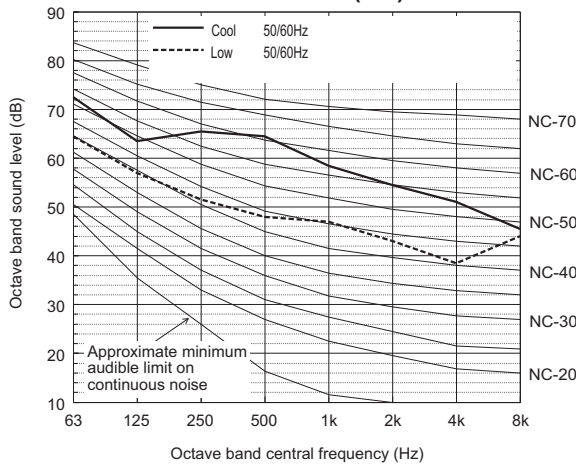

| | | 63 | 125 | 250 | 500 | 1k | 2k | 4k | 8k | dB(A) |
|------------------|---------|------|------|------|------|------|------|------|------|-------|
| Standard Cooling | 50/60Hz | 72.5 | 63.5 | 65.5 | 64.5 | 58.5 | 54.5 | 51.0 | 45.5 | 65.0 |
| Low noise mode | 50/60Hz | 64.5 | 57.0 | 51.5 | 48.0 | 47.0 | 43.0 | 38.5 | 44.0 | 52.5 |

When Low noise mode is set, the A/C system's capacity is limited. The system could return to normal operation from Low noise mode automatically in the case that the operation condition is severe.

- Depending on the operation conditions, the unit generates noise caused by valve actuation, refrigerant flow, and pressure changes when operating normally. Please consider to avoid location where quietness is required. The sound pressure level measured by the conventional method in JIS for reference purpose.

PUHY-P-Y(S)NW-A1

Measurement condition
PUHY-P500YNW-A1(-BS)

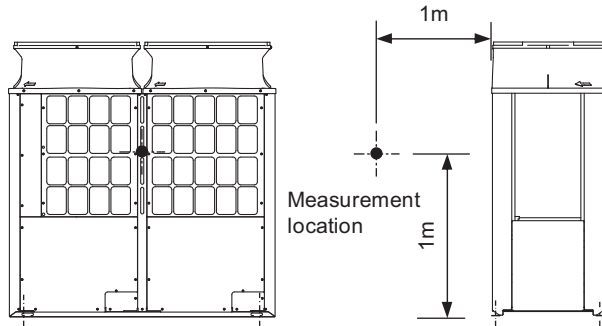

Measurement condition
PUHY-P400, 450, 500, 550, 600YSNW-A1(-BS)

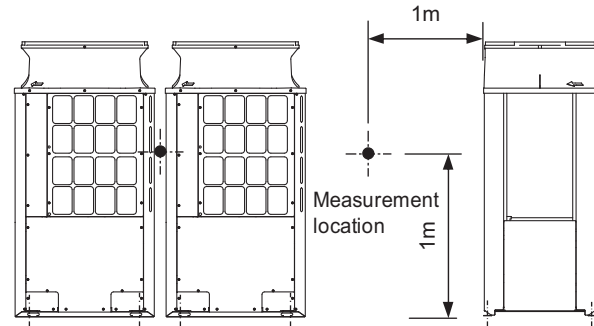

Sound level of PUHY-P500YNW-A1(-BS)

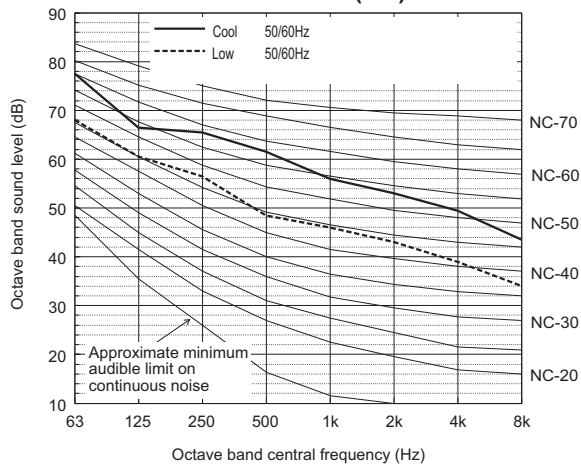

| | | 63 | 125 | 250 | 500 | 1k | 2k | 4k | 8k | dB(A) |
|------------------|---------|------|------|------|------|------|------|------|------|-------|
| Standard Cooling | 50/60Hz | 77.5 | 66.5 | 65.5 | 61.5 | 56.0 | 53.0 | 49.5 | 43.5 | 63.5 |
| Low noise mode | 50/60Hz | 68.0 | 60.5 | 56.5 | 48.5 | 46.0 | 43.0 | 39.0 | 34.0 | 53.5 |

When Low noise mode is set, the A/C system's capacity is limited. The system could return to normal operation from Low noise mode automatically in the case that the operation condition is severe.

Sound level of PUHY-P400YSNW-A1(-BS)

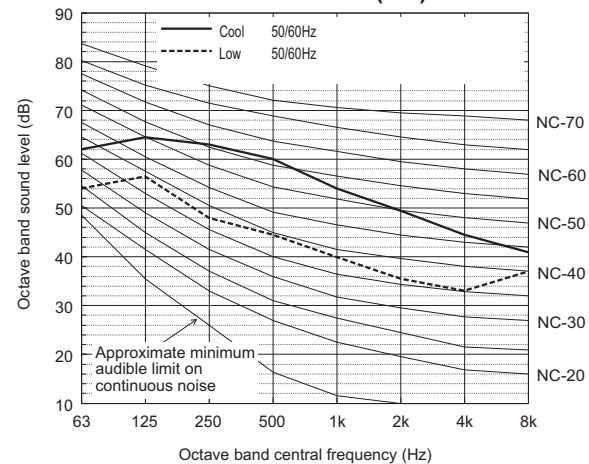

| | | 63 | 125 | 250 | 500 | 1k | 2k | 4k | 8k | dB(A) |
|------------------|---------|------|------|------|------|------|------|------|------|-------|
| Standard Cooling | 50/60Hz | 62.0 | 64.5 | 63.0 | 60.0 | 54.0 | 49.5 | 44.5 | 41.0 | 61.0 |
| Low noise mode | 50/60Hz | 54.0 | 56.5 | 48.0 | 44.5 | 40.0 | 35.5 | 33.0 | 37.0 | 47.5 |

When Low noise mode is set, the A/C system's capacity is limited. The system could return to normal operation from Low noise mode automatically in the case that the operation condition is severe.

Sound level of PUHY-P450YSNW-A1(-BS)

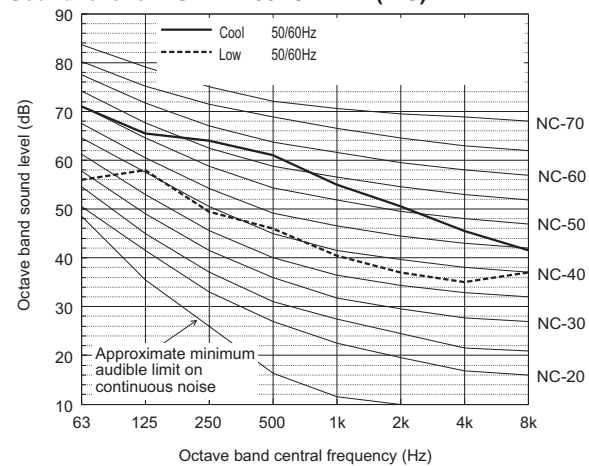

| | | 63 | 125 | 250 | 500 | 1k | 2k | 4k | 8k | dB(A) |
|------------------|---------|------|------|------|------|------|------|------|------|-------|
| Standard Cooling | 50/60Hz | 71.0 | 65.5 | 64.0 | 61.0 | 55.0 | 50.5 | 45.5 | 41.5 | 62.0 |
| Low noise mode | 50/60Hz | 56.0 | 58.0 | 49.5 | 46.0 | 40.5 | 37.0 | 35.0 | 37.0 | 48.5 |

When Low noise mode is set, the A/C system's capacity is limited. The system could return to normal operation from Low noise mode automatically in the case that the operation condition is severe.

- Depending on the operation conditions, the unit generates noise caused by valve actuation, refrigerant flow, and pressure changes when operating normally. Please consider to avoid location where quietness is required. The sound pressure level measured by the conventional method in JIS for reference purpose.

Sound level of PUHY-P500YSNW-A1(-BS)

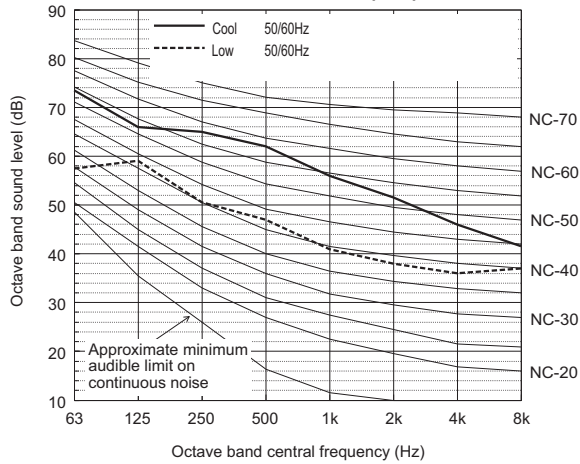

| | | 63 | 125 | 250 | 500 | 1k | 2k | 4k | 8k | dB(A) |
|------------------|---------|------|------|------|------|------|------|------|------|-------|
| Standard Cooling | 50/60Hz | 73.5 | 66.0 | 65.0 | 62.0 | 56.0 | 51.5 | 46.0 | 41.5 | 63.0 |
| Low noise mode | 50/60Hz | 57.5 | 59.0 | 50.5 | 47.0 | 41.0 | 38.0 | 36.0 | 37.0 | 49.5 |

When Low noise mode is set, the A/C system's capacity is limited. The system could return to normal operation from Low noise mode automatically in the case that the operation condition is severe.

Measurement condition
PUHY-P650YSNW-A1(-BS)

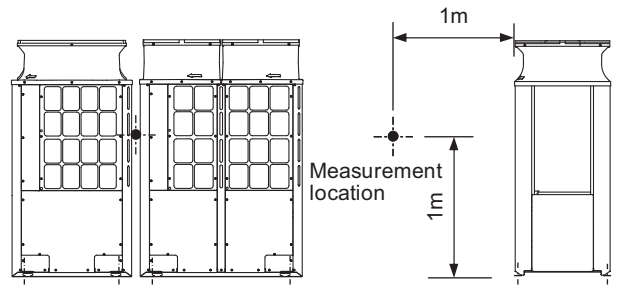

Sound level of PUHY-P550YSNW-A1(-BS)

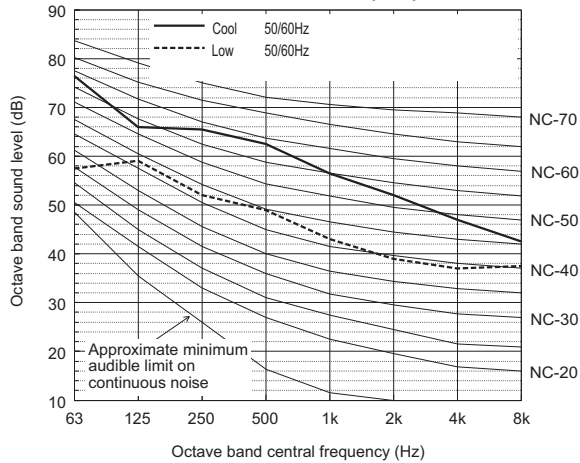

| | | 63 | 125 | 250 | 500 | 1k | 2k | 4k | 8k | dB(A) |
|------------------|---------|------|------|------|------|------|------|------|------|-------|
| Standard Cooling | 50/60Hz | 76.5 | 66.0 | 65.5 | 62.5 | 56.5 | 52.0 | 47.0 | 42.5 | 63.5 |
| Low noise mode | 50/60Hz | 57.5 | 59.0 | 52.0 | 49.0 | 43.0 | 39.0 | 37.0 | 37.5 | 51.0 |

When Low noise mode is set, the A/C system's capacity is limited. The system could return to normal operation from Low noise mode automatically in the case that the operation condition is severe.

Sound level of PUHY-P650YSNW-A1(-BS)

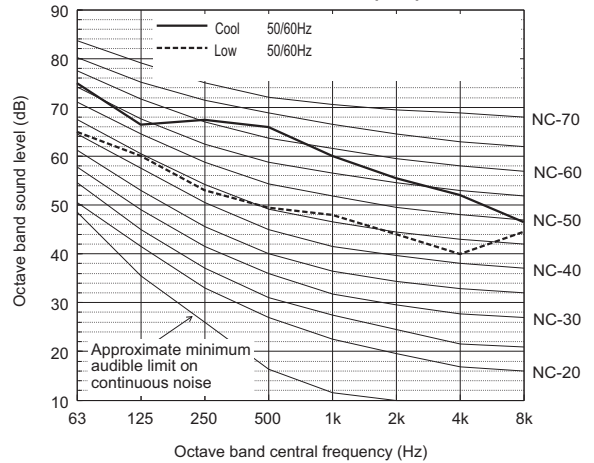

| | | 63 | 125 | 250 | 500 | 1k | 2k | 4k | 8k | dB(A) |
|------------------|---------|------|------|------|------|------|------|------|------|-------|
| Standard Cooling | 50/60Hz | 75.0 | 66.5 | 67.5 | 66.0 | 60.0 | 55.5 | 52.0 | 46.5 | 66.5 |
| Low noise mode | 50/60Hz | 65.0 | 60.0 | 53.0 | 49.5 | 48.0 | 44.0 | 40.0 | 44.5 | 53.5 |

When Low noise mode is set, the A/C system's capacity is limited. The system could return to normal operation from Low noise mode automatically in the case that the operation condition is severe.

Sound level of PUHY-P600YSNW-A1(-BS)

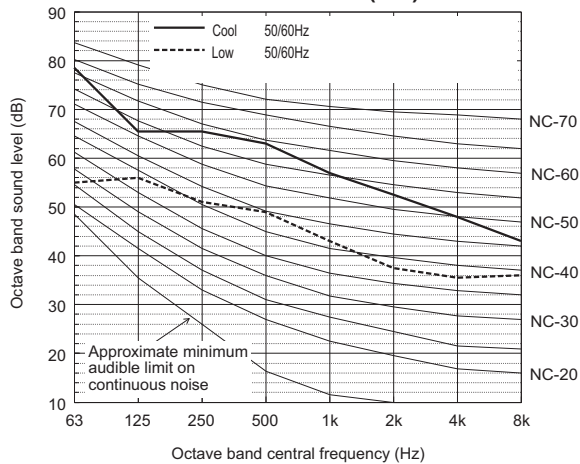

| | | 63 | 125 | 250 | 500 | 1k | 2k | 4k | 8k | dB(A) |
|------------------|---------|------|------|------|------|------|------|------|------|-------|
| Standard Cooling | 50/60Hz | 78.5 | 65.5 | 65.5 | 63.0 | 57.0 | 52.5 | 48.0 | 43.0 | 64.0 |
| Low noise mode | 50/60Hz | 55.0 | 56.0 | 51.0 | 49.0 | 43.0 | 37.5 | 35.5 | 36.0 | 50.0 |

When Low noise mode is set, the A/C system's capacity is limited. The system could return to normal operation from Low noise mode automatically in the case that the operation condition is severe.

• Depending on the operation conditions, the unit generates noise caused by valve actuation, refrigerant flow, and pressure changes when operating normally. Please consider to avoid location where quietness is required.
The sound pressure level measured by the conventional method in JIS for reference purpose.

PUHY-P-Y(S)NW-A1

Measurement condition
PUHY-P700, 750, 800, 850, 900YSNW-A1(-BS)

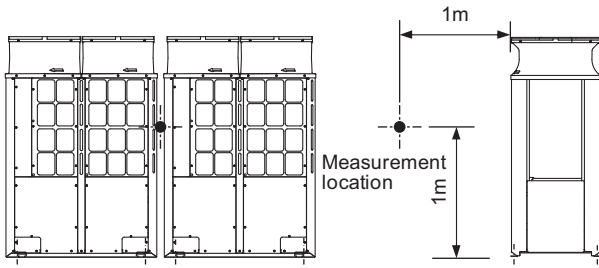

Sound level of PUHY-P800YSNW-A1(-BS)

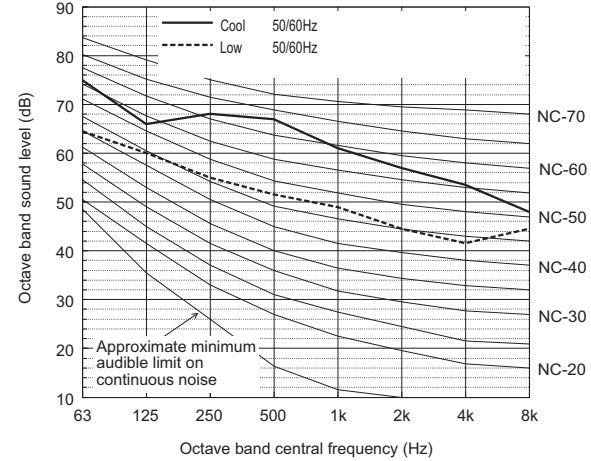

| | | 63 | 125 | 250 | 500 | 1k | 2k | 4k | 8k | dB(A) |
|------------------|---------|------|------|------|------|------|------|------|------|-------|
| Standard Cooling | 50/60Hz | 75.0 | 66.0 | 68.0 | 67.0 | 61.0 | 57.0 | 53.5 | 48.0 | 67.5 |
| Low noise mode | 50/60Hz | 64.5 | 60.0 | 55.0 | 51.5 | 49.0 | 44.5 | 41.5 | 44.5 | 55.0 |

When Low noise mode is set, the A/C system's capacity is limited. The system could return to normal operation from Low noise mode automatically in the case that the operation condition is severe.

Sound level of PUHY-P700YSNW-A1(-BS)

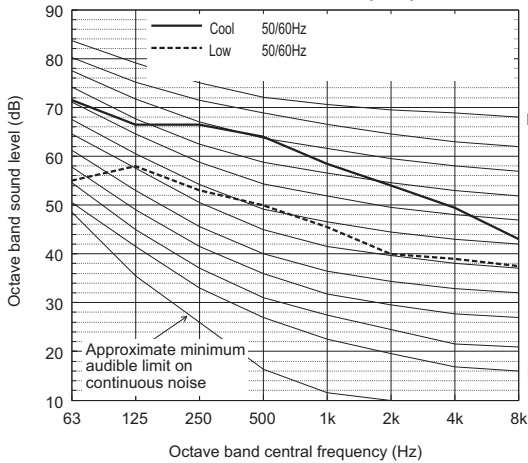

| | | 63 | 125 | 250 | 500 | 1k | 2k | 4k | 8k | dB(A) |
|------------------|---------|------|------|------|------|------|------|------|------|-------|
| Standard Cooling | 50/60Hz | 71.5 | 66.5 | 66.5 | 64.0 | 58.5 | 54.0 | 49.5 | 43.0 | 65.0 |
| Low noise mode | 50/60Hz | 55.0 | 58.0 | 53.0 | 50.0 | 45.5 | 40.0 | 39.0 | 37.5 | 52.0 |

When Low noise mode is set, the A/C system's capacity is limited. The system could return to normal operation from Low noise mode automatically in the case that the operation condition is severe.

Sound level of PUHY-P850YSNW-A1(-BS)

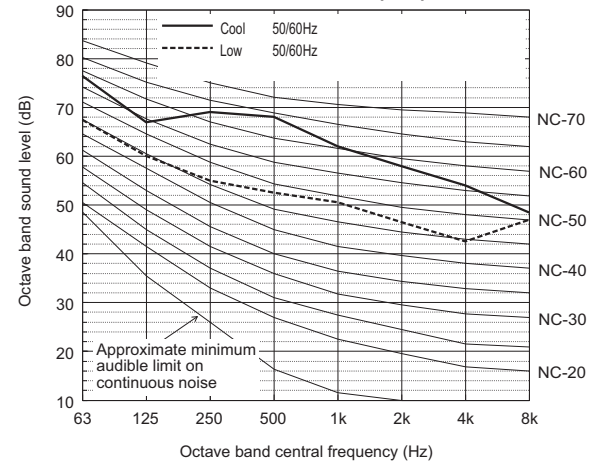

| | | 63 | 125 | 250 | 500 | 1k | 2k | 4k | 8k | dB(A) |
|------------------|---------|------|------|------|------|------|------|------|------|-------|
| Standard Cooling | 50/60Hz | 76.5 | 67.0 | 69.0 | 68.0 | 62.0 | 58.0 | 54.0 | 48.5 | 68.5 |
| Low noise mode | 50/60Hz | 67.5 | 60.0 | 55.0 | 52.5 | 50.5 | 46.5 | 42.5 | 47.0 | 56.0 |

When Low noise mode is set, the A/C system's capacity is limited. The system could return to normal operation from Low noise mode automatically in the case that the operation condition is severe.

Sound level of PUHY-P750YSNW-A1(-BS)

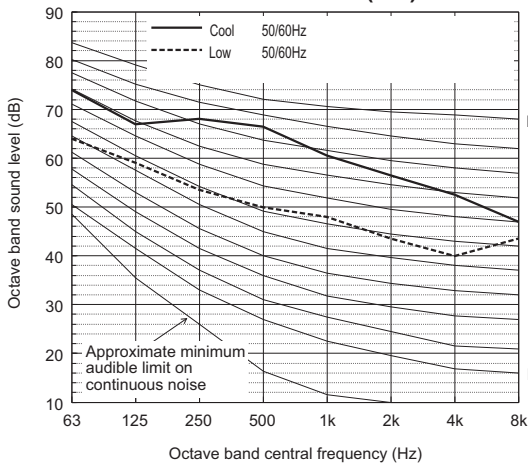

| | | 63 | 125 | 250 | 500 | 1k | 2k | 4k | 8k | dB(A) |
|------------------|---------|------|------|------|------|------|------|------|------|-------|
| Standard Cooling | 50/60Hz | 74.0 | 67.0 | 68.0 | 66.5 | 60.5 | 56.5 | 52.5 | 47.0 | 67.0 |
| Low noise mode | 50/60Hz | 64.0 | 59.0 | 53.5 | 50.0 | 48.0 | 43.5 | 40.0 | 43.5 | 53.5 |

When Low noise mode is set, the A/C system's capacity is limited. The system could return to normal operation from Low noise mode automatically in the case that the operation condition is severe.

Sound level of PUHY-P900YSNW-A1(-BS)

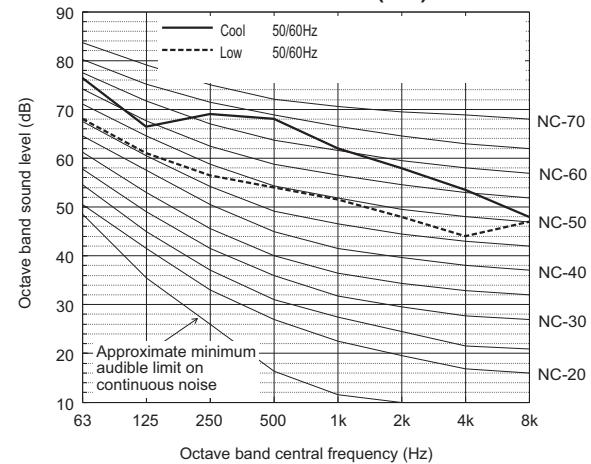

| | | 63 | 125 | 250 | 500 | 1k | 2k | 4k | 8k | dB(A) |
|------------------|---------|------|------|------|------|------|------|------|------|-------|
| Standard Cooling | 50/60Hz | 76.5 | 66.5 | 69.0 | 68.0 | 62.0 | 58.0 | 53.5 | 48.0 | 68.5 |
| Low noise mode | 50/60Hz | 68.0 | 61.0 | 56.5 | 54.0 | 51.5 | 48.0 | 44.0 | 47.0 | 57.0 |

When Low noise mode is set, the A/C system's capacity is limited. The system could return to normal operation from Low noise mode automatically in the case that the operation condition is severe.

♦ Depending on the operation conditions, the unit generates noise caused by valve actuation, refrigerant flow, and pressure changes when operating normally. Please consider to avoid location where quietness is required.
 The sound pressure level measured by the conventional method in JIS for reference purpose.

Measurement condition
PUHY-P950, 1000, 1050YSNW-A1(-BS)

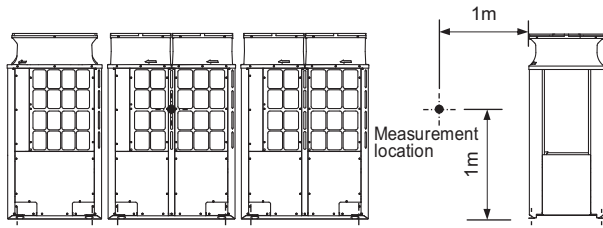

Sound level of PUHY-P1050YSNW-A1(-BS)

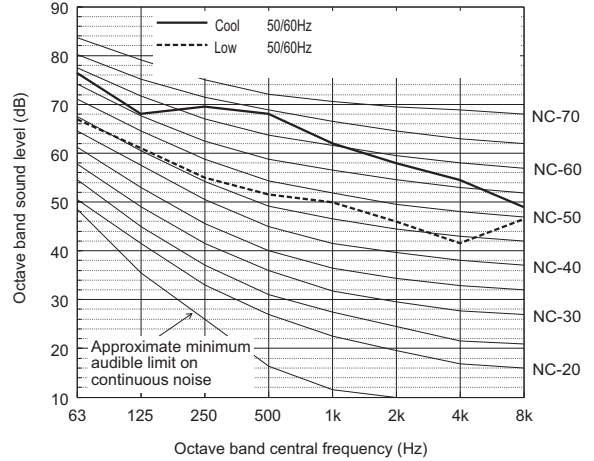

| | | 63 | 125 | 250 | 500 | 1k | 2k | 4k | 8k | dB(A) |
|------------------|---------|------|------|------|------|------|------|------|------|-------|
| Standard Cooling | 50/60Hz | 76.5 | 68.0 | 69.5 | 68.0 | 62.0 | 58.0 | 54.5 | 49.0 | 68.5 |
| Low noise mode | 50/60Hz | 67.0 | 61.0 | 55.0 | 51.5 | 50.0 | 46.0 | 41.5 | 46.5 | 55.5 |

When Low noise mode is set, the A/C system's capacity is limited. The system could return to normal operation from Low noise mode automatically in the case that the operation condition is severe.

Sound level of PUHY-P950YSNW-A1(-BS)

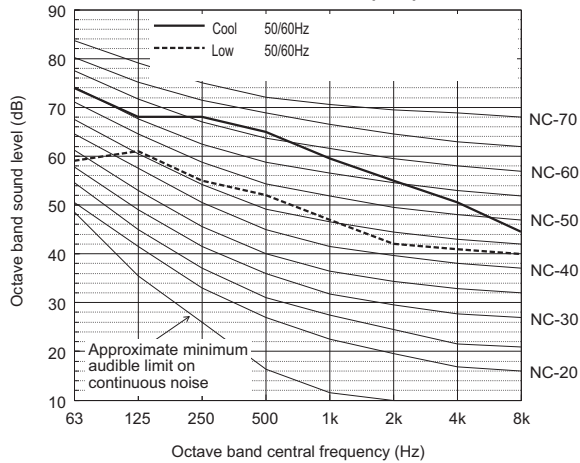

| | | 63 | 125 | 250 | 500 | 1k | 2k | 4k | 8k | dB(A) |
|------------------|---------|------|------|------|------|------|------|------|------|-------|
| Standard Cooling | 50/60Hz | 74.0 | 68.0 | 68.0 | 65.0 | 59.5 | 55.0 | 50.5 | 44.5 | 66.0 |
| Low noise mode | 50/60Hz | 59.0 | 61.0 | 55.0 | 52.0 | 47.0 | 42.0 | 41.0 | 40.0 | 54.0 |

When Low noise mode is set, the A/C system's capacity is limited. The system could return to normal operation from Low noise mode automatically in the case that the operation condition is severe.

Sound level of PUHY-P1000YSNW-A1(-BS)

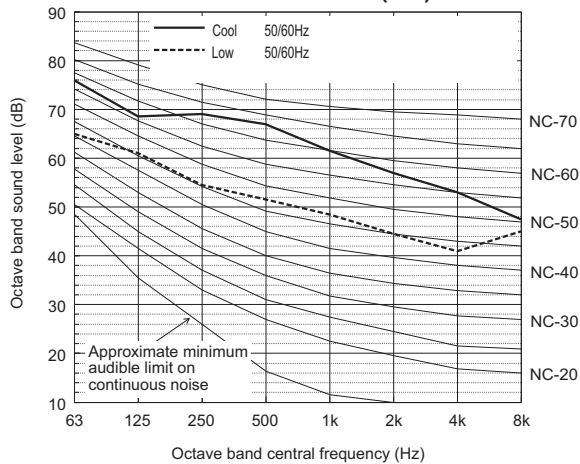

| | | 63 | 125 | 250 | 500 | 1k | 2k | 4k | 8k | dB(A) |
|------------------|---------|------|------|------|------|------|------|------|------|-------|
| Standard Cooling | 50/60Hz | 76.0 | 68.5 | 69.0 | 67.0 | 61.5 | 57.0 | 53.0 | 47.5 | 68.0 |
| Low noise mode | 50/60Hz | 65.0 | 61.0 | 54.5 | 51.5 | 48.5 | 44.5 | 41.0 | 45.0 | 54.5 |

When Low noise mode is set, the A/C system's capacity is limited. The system could return to normal operation from Low noise mode automatically in the case that the operation condition is severe.

- Depending on the operation conditions, the unit generates noise caused by valve actuation, refrigerant flow, and pressure changes when operating normally. Please consider to avoid location where quietness is required. The sound pressure level measured by the conventional method in JIS for reference purpose.

PUHY-P-Y(S)NW-A1

Measurement condition
PUHY-P1100, 1150, 1200, 1250, 1300, 1350YSNW-A1(-BS)

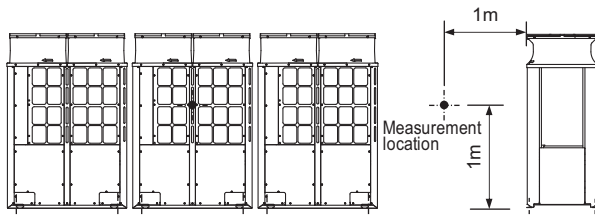

Sound level of PUHY-P1200YSNW-A1(-BS)

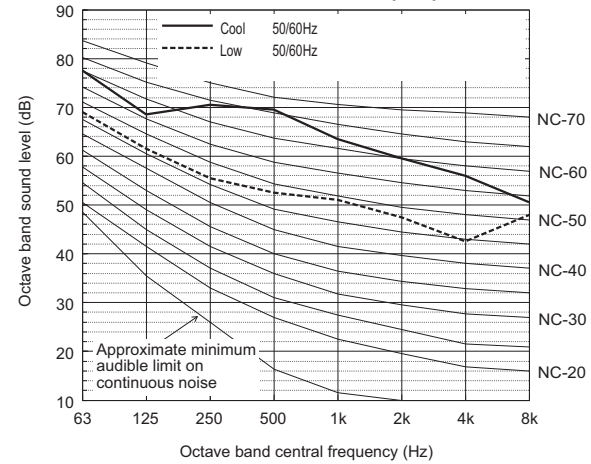

| | | 63 | 125 | 250 | 500 | 1k | 2k | 4k | 8k | dB(A) |
|------------------|---------|------|------|------|------|------|------|------|------|-------|
| Standard Cooling | 50/60Hz | 77.5 | 68.5 | 70.5 | 69.5 | 63.5 | 59.5 | 56.0 | 50.5 | 70.0 |
| Low noise mode | 50/60Hz | 69.0 | 61.5 | 55.5 | 52.5 | 51.0 | 47.5 | 42.5 | 48.0 | 56.5 |

When Low noise mode is set, the A/C system's capacity is limited. The system could return to normal operation from Low noise mode automatically in the case that the operation condition is severe.

Sound level of PUHY-P1100YSNW-A1(-BS)

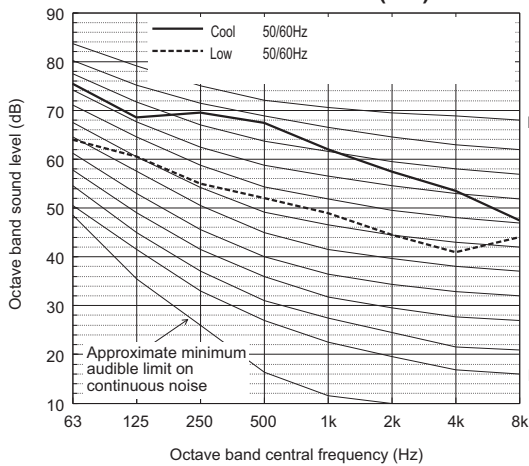

| | | 63 | 125 | 250 | 500 | 1k | 2k | 4k | 8k | dB(A) |
|------------------|---------|------|------|------|------|------|------|------|------|-------|
| Standard Cooling | 50/60Hz | 75.5 | 68.5 | 69.5 | 67.5 | 62.0 | 57.5 | 53.5 | 47.5 | 68.5 |
| Low noise mode | 50/60Hz | 64.0 | 60.5 | 55.0 | 52.0 | 49.0 | 44.5 | 41.0 | 44.0 | 55.0 |

When Low noise mode is set, the A/C system's capacity is limited. The system could return to normal operation from Low noise mode automatically in the case that the operation condition is severe.

Sound level of PUHY-P1250YSNW-A1(-BS)

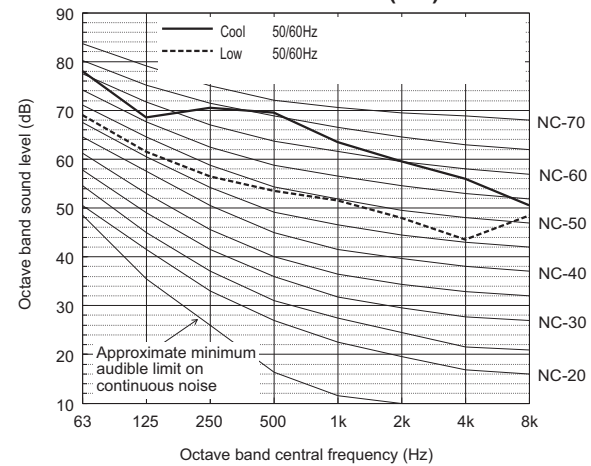

| | | 63 | 125 | 250 | 500 | 1k | 2k | 4k | 8k | dB(A) |
|------------------|---------|------|------|------|------|------|------|------|------|-------|
| Standard Cooling | 50/60Hz | 78.0 | 68.5 | 70.5 | 69.5 | 63.5 | 59.5 | 56.0 | 50.5 | 70.0 |
| Low noise mode | 50/60Hz | 69.0 | 61.5 | 56.5 | 53.5 | 51.5 | 48.0 | 43.5 | 48.5 | 57.0 |

When Low noise mode is set, the A/C system's capacity is limited. The system could return to normal operation from Low noise mode automatically in the case that the operation condition is severe.

Sound level of PUHY-P1150YSNW-A1(-BS)

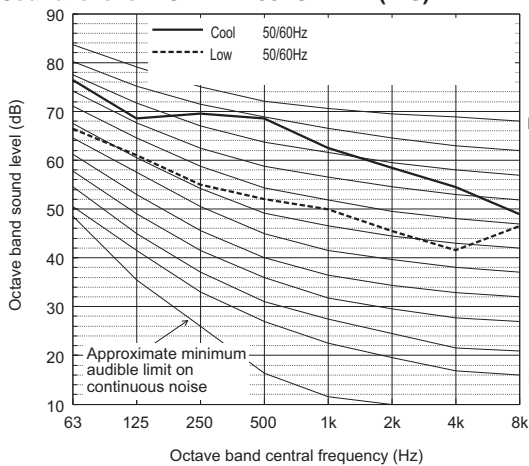

| | | 63 | 125 | 250 | 500 | 1k | 2k | 4k | 8k | dB(A) |
|------------------|---------|------|------|------|------|------|------|------|------|-------|
| Standard Cooling | 50/60Hz | 76.5 | 68.5 | 69.5 | 68.5 | 62.5 | 58.5 | 54.5 | 49.0 | 69.0 |
| Low noise mode | 50/60Hz | 66.5 | 61.0 | 55.0 | 52.0 | 50.0 | 45.5 | 41.5 | 46.5 | 55.5 |

When Low noise mode is set, the A/C system's capacity is limited. The system could return to normal operation from Low noise mode automatically in the case that the operation condition is severe.

Sound level of PUHY-P1300YSNW-A1(-BS)

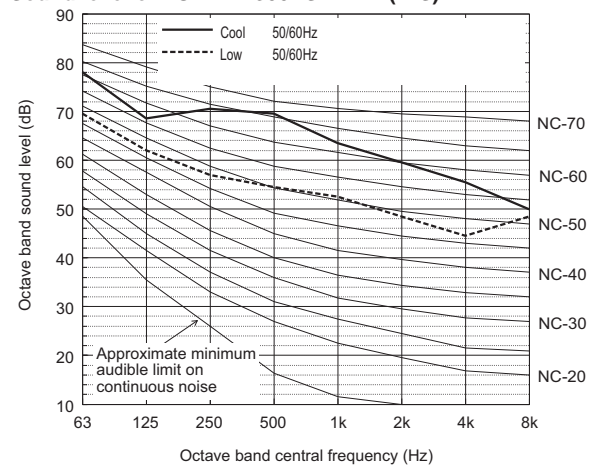

| | | 63 | 125 | 250 | 500 | 1k | 2k | 4k | 8k | dB(A) |
|------------------|---------|------|------|------|------|------|------|------|------|-------|
| Standard Cooling | 50/60Hz | 78.0 | 68.5 | 70.5 | 69.5 | 63.5 | 59.5 | 55.5 | 50.0 | 70.0 |
| Low noise mode | 50/60Hz | 69.5 | 62.0 | 57.0 | 54.5 | 52.5 | 48.5 | 44.5 | 48.5 | 58.0 |

When Low noise mode is set, the A/C system's capacity is limited. The system could return to normal operation from Low noise mode automatically in the case that the operation condition is severe.

• Depending on the operation conditions, the unit generates noise caused by valve actuation, refrigerant flow, and pressure changes when operating normally. Please consider to avoid location where quietness is required.
 The sound pressure level measured by the conventional method in JIS for reference purpose.

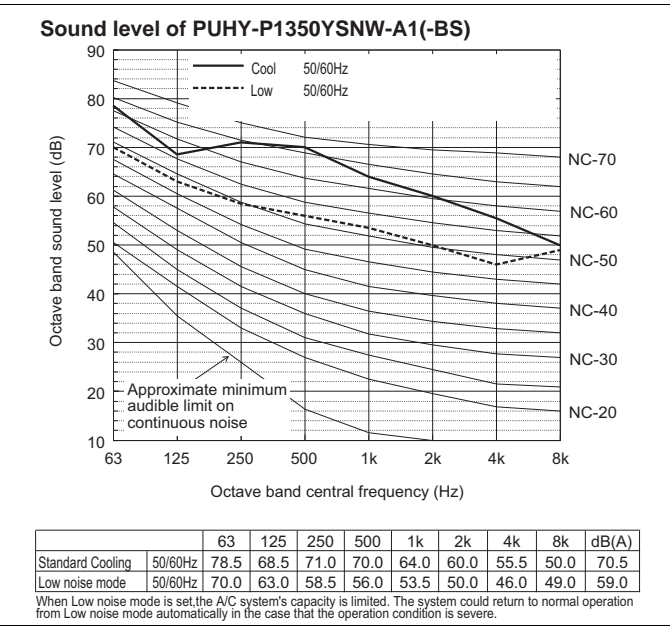

PUHY-P-Y(S)NW-A1

- Depending on the operation conditions, the unit generates noise caused by valve actuation, refrigerant flow, and pressure changes when operating normally. Please consider to avoid location where quietness is required. The sound pressure level measured by the conventional method in JIS for reference purpose.

5-2. Sound levels in heating mode

PUHY-P-Y(S)NW-A1

Measurement condition
PUHY-P200, 250, 300YNW-A1(-BS)

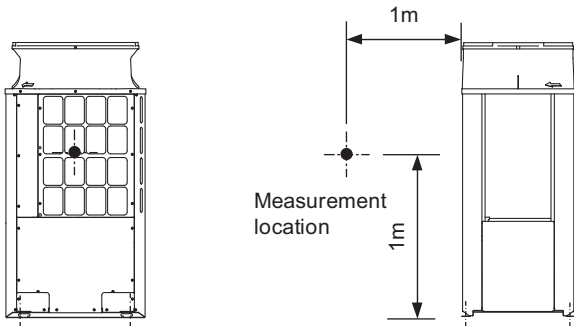

Sound level of PUHY-P300YNW-A1(-BS)

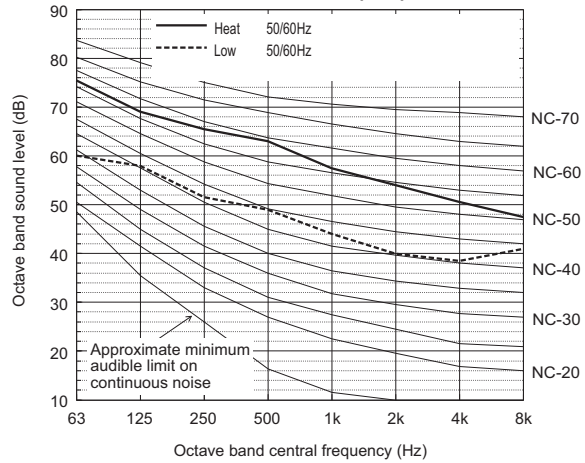

| | | 63 | 125 | 250 | 500 | 1k | 2k | 4k | 8k | dB(A) |
|------------------|---------|------|------|------|------|------|------|------|------|-------|
| Standard Heating | 50/60Hz | 75.5 | 69.0 | 65.5 | 63.0 | 57.5 | 54.0 | 50.5 | 47.5 | 64.5 |
| Low noise mode | 50/60Hz | 60.0 | 58.0 | 51.5 | 49.0 | 44.0 | 40.0 | 38.5 | 41.0 | 51.0 |

When Low noise mode is set, the A/C system's capacity is limited. The system could return to normal operation from Low noise mode automatically in the case that the operation condition is severe.

Sound level of PUHY-P200YNW-A1(-BS)

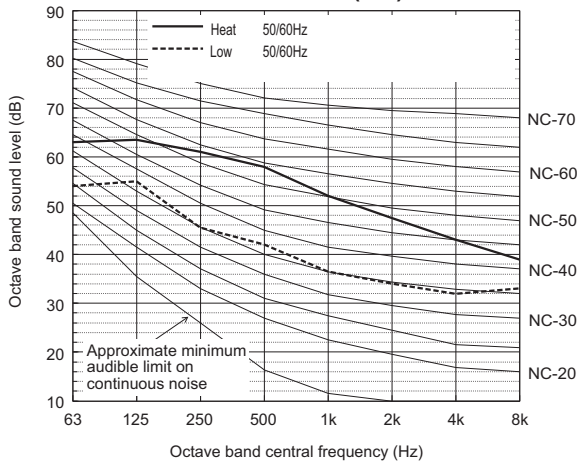

| | | 63 | 125 | 250 | 500 | 1k | 2k | 4k | 8k | dB(A) |
|------------------|---------|------|------|------|------|------|------|------|------|-------|
| Standard Heating | 50/60Hz | 63.0 | 63.5 | 61.0 | 58.0 | 52.0 | 47.5 | 43.0 | 39.0 | 59.0 |
| Low noise mode | 50/60Hz | 54.0 | 55.0 | 45.5 | 42.0 | 36.5 | 34.0 | 32.0 | 33.0 | 45.0 |

When Low noise mode is set, the A/C system's capacity is limited. The system could return to normal operation from Low noise mode automatically in the case that the operation condition is severe.

Sound level of PUHY-P250YNW-A1(-BS)

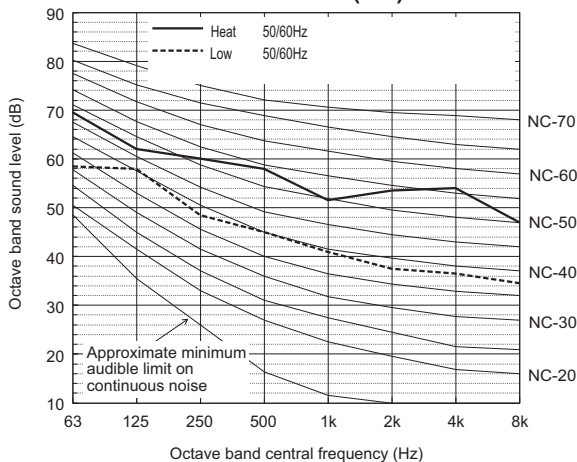

| | | 63 | 125 | 250 | 500 | 1k | 2k | 4k | 8k | dB(A) |
|------------------|---------|------|------|------|------|------|------|------|------|-------|
| Standard Heating | 50/60Hz | 69.5 | 62.0 | 60.0 | 58.0 | 51.5 | 53.5 | 54.0 | 47.0 | 61.0 |
| Low noise mode | 50/60Hz | 58.5 | 58.0 | 48.5 | 45.0 | 41.0 | 37.5 | 36.5 | 34.5 | 48.5 |

When Low noise mode is set, the A/C system's capacity is limited. The system could return to normal operation from Low noise mode automatically in the case that the operation condition is severe.

• Depending on the operation conditions, the unit generates noise caused by valve actuation, refrigerant flow, and pressure changes when operating normally. Please consider to avoid location where quietness is required. The sound pressure level measured by the conventional method in JIS for reference purpose.

Measurement condition
PUHY-P350, 400, 450YNW-A1(-BS)

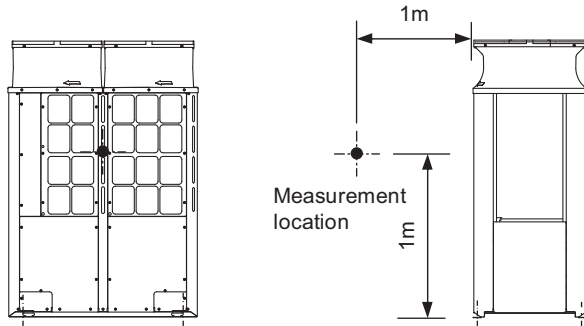

Sound level of PUHY-P450YNW-A1(-BS)

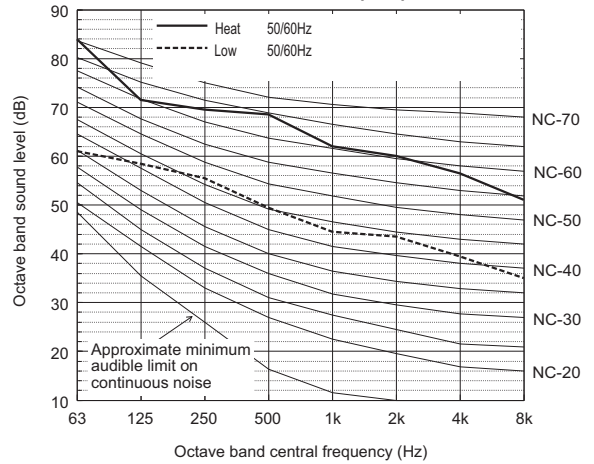

| | | 63 | 125 | 250 | 500 | 1k | 2k | 4k | 8k | dB(A) |
|------------------|---------|------|------|------|------|------|------|------|------|-------|
| Standard Heating | 50/60Hz | 84.0 | 71.5 | 69.5 | 68.5 | 62.0 | 60.0 | 56.5 | 51.0 | 69.5 |
| Low noise mode | 50/60Hz | 61.0 | 58.5 | 55.5 | 49.5 | 44.5 | 43.5 | 39.5 | 35.0 | 52.5 |

When Low noise mode is set, the A/C system's capacity is limited. The system could return to normal operation from Low noise mode automatically in the case that the operation condition is severe.

Sound level of PUHY-P350YNW-A1(-BS)

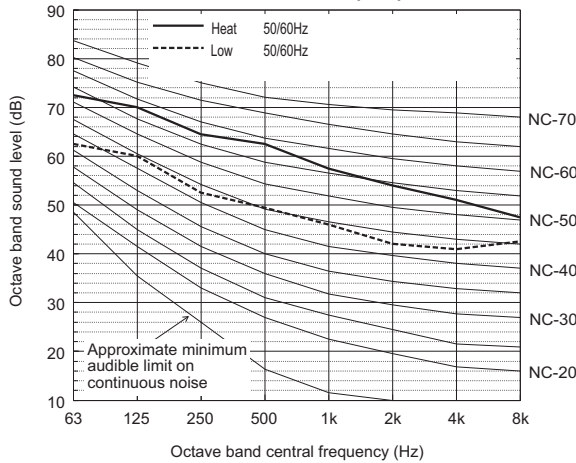

| | | 63 | 125 | 250 | 500 | 1k | 2k | 4k | 8k | dB(A) |
|------------------|---------|------|------|------|------|------|------|------|------|-------|
| Standard Heating | 50/60Hz | 72.5 | 70.0 | 64.5 | 62.5 | 57.5 | 54.0 | 51.0 | 47.5 | 64.0 |
| Low noise mode | 50/60Hz | 62.5 | 60.0 | 52.5 | 49.5 | 46.0 | 42.0 | 41.0 | 42.5 | 52.5 |

When Low noise mode is set, the A/C system's capacity is limited. The system could return to normal operation from Low noise mode automatically in the case that the operation condition is severe.

Sound level of PUHY-P400YNW-A1(-BS)

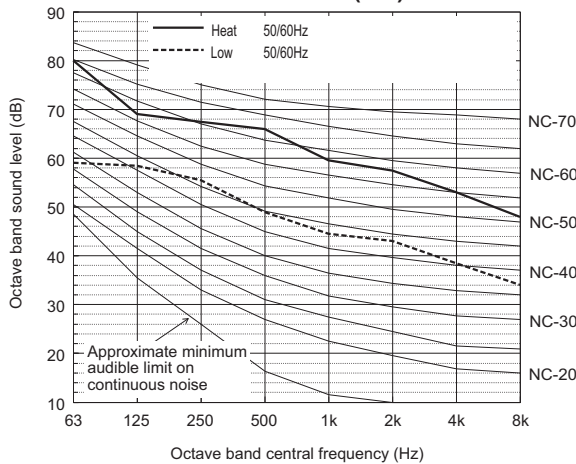

| | | 63 | 125 | 250 | 500 | 1k | 2k | 4k | 8k | dB(A) |
|------------------|---------|------|------|------|------|------|------|------|------|-------|
| Standard Heating | 50/60Hz | 80.0 | 69.0 | 67.5 | 66.0 | 59.5 | 57.5 | 53.0 | 48.0 | 67.0 |
| Low noise mode | 50/60Hz | 59.0 | 58.5 | 55.5 | 49.0 | 44.5 | 43.0 | 38.5 | 34.0 | 52.5 |

When Low noise mode is set, the A/C system's capacity is limited. The system could return to normal operation from Low noise mode automatically in the case that the operation condition is severe.

- Depending on the operation conditions, the unit generates noise caused by valve actuation, refrigerant flow, and pressure changes when operating normally. Please consider to avoid location where quietness is required. The sound pressure level measured by the conventional method in JIS for reference purpose.

PUHY-P-Y(S)NW-A1

Measurement condition
PUHY-P500YNW-A1(-BS)

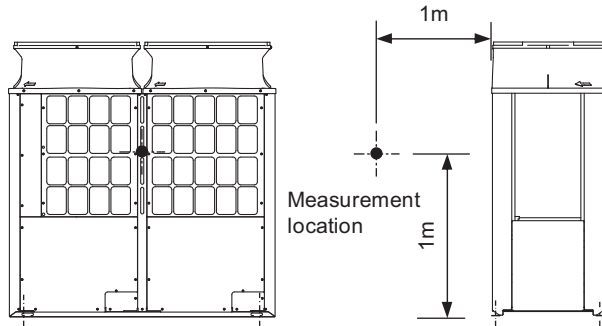

Measurement condition
PUHY-P400, 450, 500, 550, 600YSNW-A1(-BS)

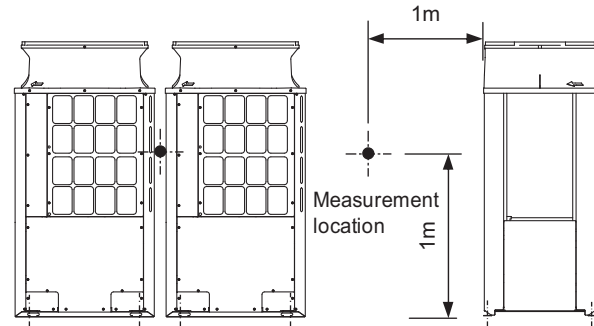

Sound level of PUHY-P500YNW-A1(-BS)

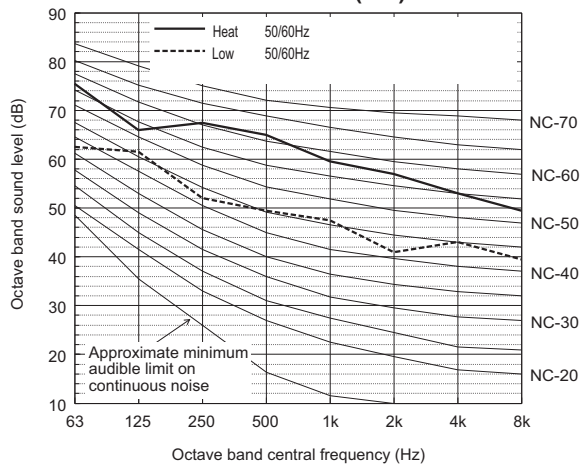

| | | 63 | 125 | 250 | 500 | 1k | 2k | 4k | 8k | dB(A) |
|------------------|---------|------|------|------|------|------|------|------|------|-------|
| Standard Heating | 50/60Hz | 75.5 | 66.0 | 67.5 | 65.0 | 59.5 | 57.0 | 53.0 | 49.5 | 66.5 |
| Low noise mode | 50/60Hz | 62.5 | 61.5 | 52.0 | 49.5 | 47.5 | 41.0 | 43.0 | 39.5 | 53.0 |

When Low noise mode is set, the A/C system's capacity is limited. The system could return to normal operation from Low noise mode automatically in the case that the operation condition is severe.

Sound level of PUHY-P400YSNW-A1(-BS)

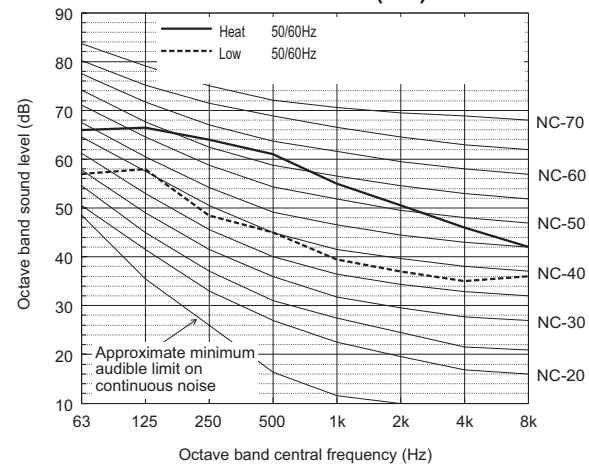

| | | 63 | 125 | 250 | 500 | 1k | 2k | 4k | 8k | dB(A) |
|------------------|---------|------|------|------|------|------|------|------|------|-------|
| Standard Heating | 50/60Hz | 66.0 | 66.5 | 64.0 | 61.0 | 55.0 | 50.5 | 46.0 | 42.0 | 62.0 |
| Low noise mode | 50/60Hz | 57.0 | 58.0 | 48.5 | 45.0 | 39.5 | 37.0 | 35.0 | 36.0 | 48.0 |

When Low noise mode is set, the A/C system's capacity is limited. The system could return to normal operation from Low noise mode automatically in the case that the operation condition is severe.

Sound level of PUHY-P450YSNW-A1(-BS)

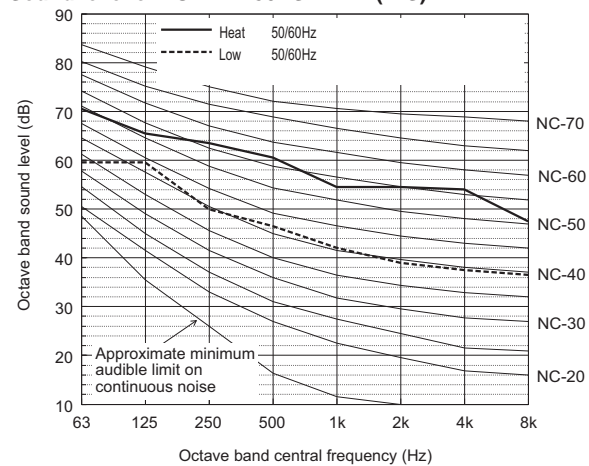

| | | 63 | 125 | 250 | 500 | 1k | 2k | 4k | 8k | dB(A) |
|------------------|---------|------|------|------|------|------|------|------|------|-------|
| Standard Heating | 50/60Hz | 70.5 | 65.5 | 63.5 | 60.5 | 54.5 | 54.5 | 54.0 | 47.5 | 63.0 |
| Low noise mode | 50/60Hz | 59.5 | 59.5 | 50.0 | 46.5 | 42.0 | 39.0 | 37.5 | 36.5 | 50.0 |

When Low noise mode is set, the A/C system's capacity is limited. The system could return to normal operation from Low noise mode automatically in the case that the operation condition is severe.

- Depending on the operation conditions, the unit generates noise caused by valve actuation, refrigerant flow, and pressure changes when operating normally. Please consider to avoid location where quietness is required. The sound pressure level measured by the conventional method in JIS for reference purpose.

Sound level of PUHY-P500YSNW-A1(-BS)

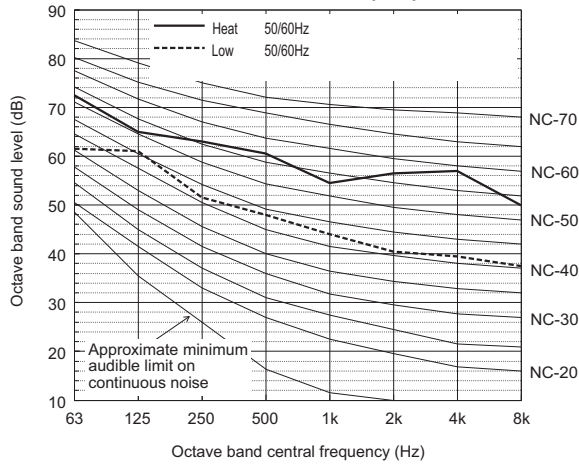

| | | 63 | 125 | 250 | 500 | 1k | 2k | 4k | 8k | dB(A) |
|------------------|---------|------|------|------|------|------|------|------|------|-------|
| Standard Heating | 50/60Hz | 72.5 | 65.0 | 63.0 | 60.5 | 54.5 | 56.5 | 57.0 | 50.0 | 64.0 |
| Low noise mode | 50/60Hz | 61.5 | 61.0 | 51.5 | 48.0 | 44.0 | 40.5 | 39.5 | 37.5 | 51.5 |

When Low noise mode is set, the A/C system's capacity is limited. The system could return to normal operation from Low noise mode automatically in the case that the operation condition is severe.

Measurement condition
PUHY-P650YSNW-A1(-BS)

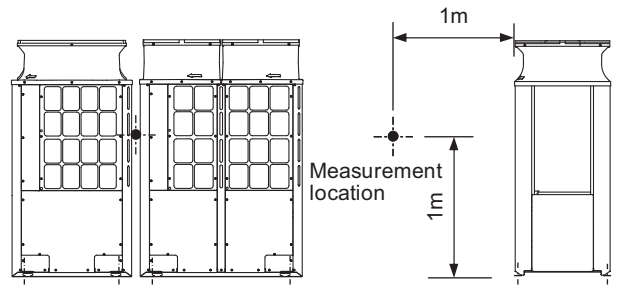

Sound level of PUHY-P550YSNW-A1(-BS)

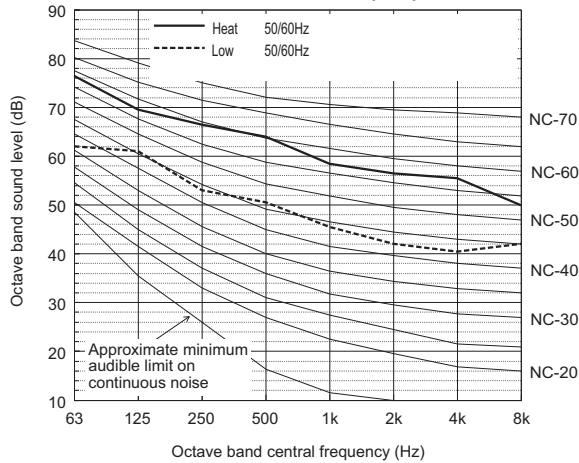

| | | 63 | 125 | 250 | 500 | 1k | 2k | 4k | 8k | dB(A) |
|------------------|---------|------|------|------|------|------|------|------|------|-------|
| Standard Heating | 50/60Hz | 76.5 | 69.5 | 66.5 | 64.0 | 58.5 | 56.5 | 55.5 | 50.0 | 66.0 |
| Low noise mode | 50/60Hz | 62.0 | 61.0 | 53.0 | 50.5 | 45.5 | 42.0 | 40.5 | 42.0 | 53.0 |

When Low noise mode is set, the A/C system's capacity is limited. The system could return to normal operation from Low noise mode automatically in the case that the operation condition is severe.

Sound level of PUHY-P650YSNW-A1(-BS)

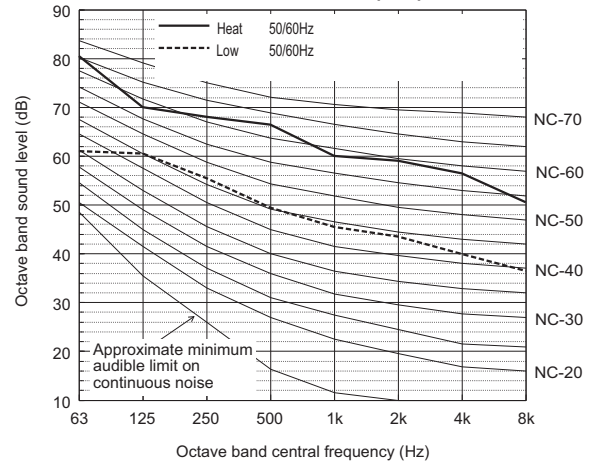

| | | 63 | 125 | 250 | 500 | 1k | 2k | 4k | 8k | dB(A) |
|------------------|---------|------|------|------|------|------|------|------|------|-------|
| Standard Heating | 50/60Hz | 80.5 | 70.0 | 68.0 | 66.5 | 60.0 | 59.0 | 56.5 | 50.5 | 68.0 |
| Low noise mode | 50/60Hz | 61.0 | 60.5 | 55.5 | 49.5 | 45.5 | 43.5 | 40.0 | 36.5 | 53.0 |

When Low noise mode is set, the A/C system's capacity is limited. The system could return to normal operation from Low noise mode automatically in the case that the operation condition is severe.

Sound level of PUHY-P600YSNW-A1(-BS)

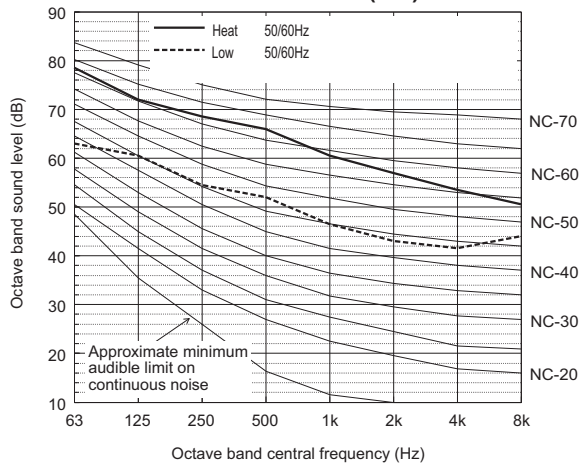

| | | 63 | 125 | 250 | 500 | 1k | 2k | 4k | 8k | dB(A) |
|------------------|---------|------|------|------|------|------|------|------|------|-------|
| Standard Heating | 50/60Hz | 78.5 | 72.0 | 68.5 | 66.0 | 60.5 | 57.0 | 53.5 | 50.5 | 67.5 |
| Low noise mode | 50/60Hz | 63.0 | 60.5 | 54.5 | 52.0 | 46.5 | 43.0 | 41.5 | 44.0 | 54.0 |

When Low noise mode is set, the A/C system's capacity is limited. The system could return to normal operation from Low noise mode automatically in the case that the operation condition is severe.

• Depending on the operation conditions, the unit generates noise caused by valve actuation, refrigerant flow, and pressure changes when operating normally. Please consider to avoid location where quietness is required. The sound pressure level measured by the conventional method in JIS for reference purpose.

PUHY-P-Y(S)NW-A1

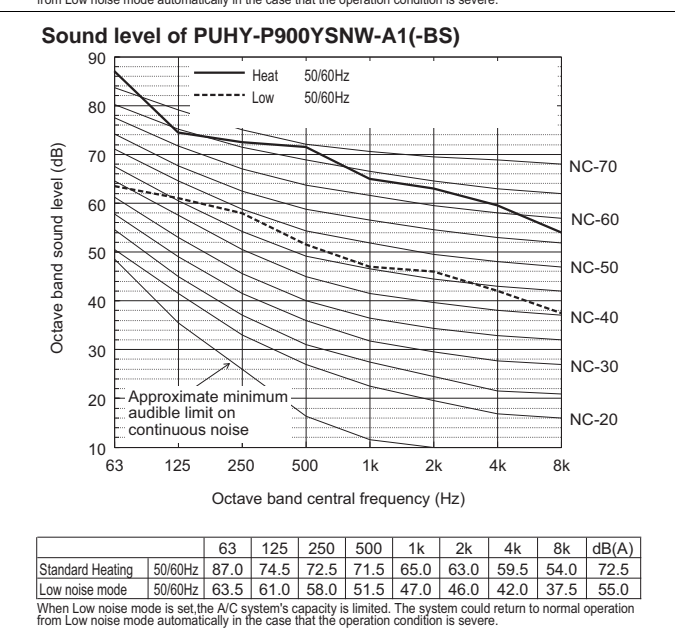
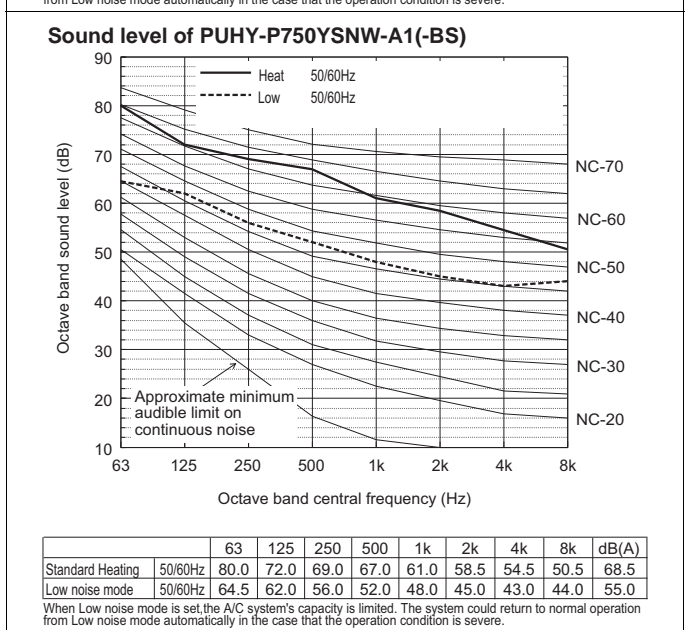
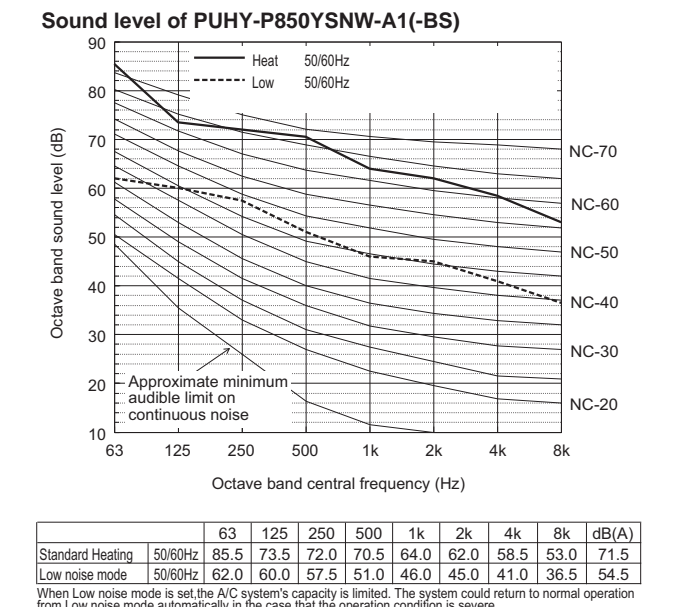
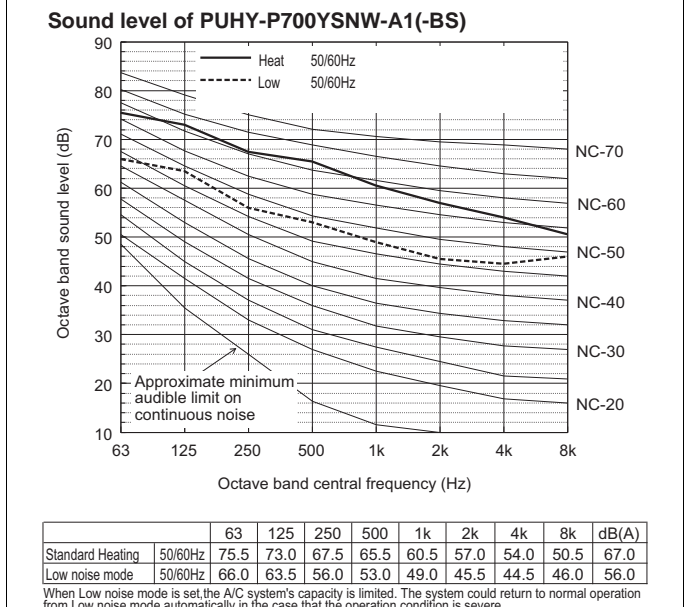
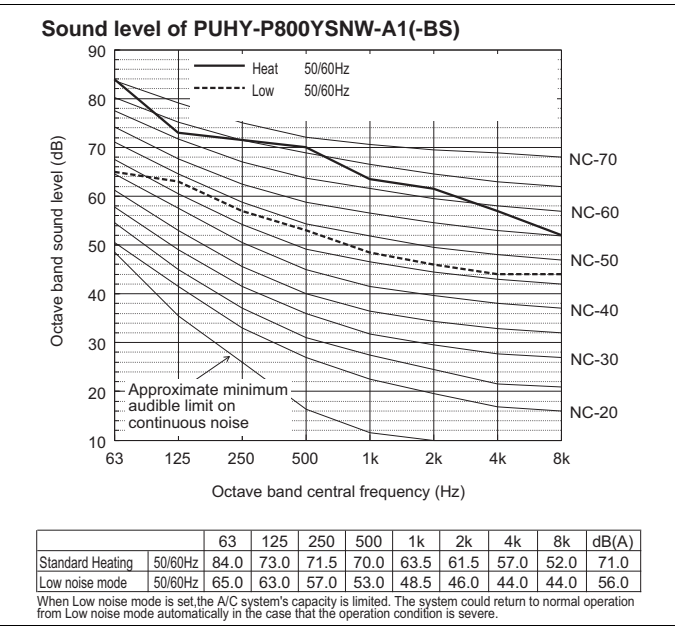
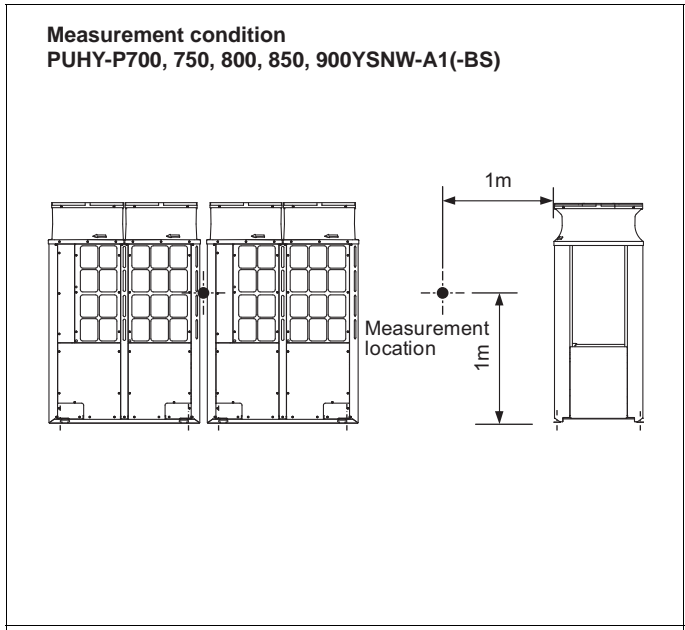

♦ Depending on the operation conditions, the unit generates noise caused by valve actuation, refrigerant flow, and pressure changes when operating normally. Please consider to avoid location where quietness is required.
 The sound pressure level measured by the conventional method in JIS for reference purpose.

Measurement condition
PUHY-P950, 1000, 1050YSNW-A1(-BS)

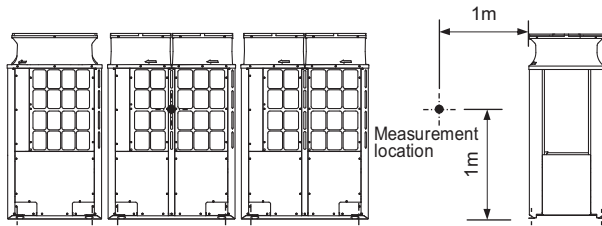

Sound level of PUHY-P1050YSNW-A1(-BS)

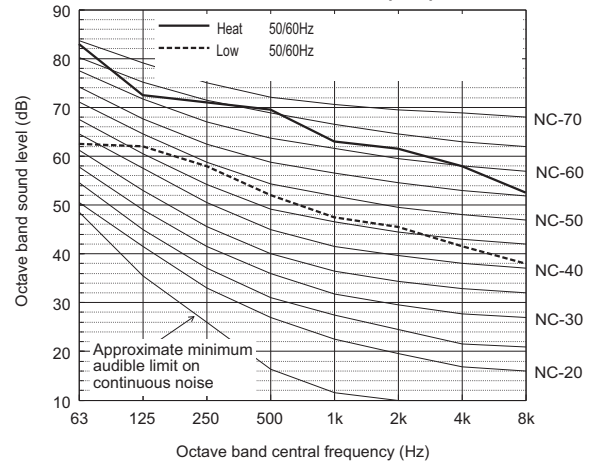

| | | 63 | 125 | 250 | 500 | 1k | 2k | 4k | 8k | dB(A) |
|------------------|---------|------|------|------|------|------|------|------|------|-------|
| Standard Heating | 50/60Hz | 83.0 | 72.5 | 71.0 | 69.5 | 63.0 | 61.5 | 58.0 | 52.5 | 70.5 |
| Low noise mode | 50/60Hz | 62.5 | 62.0 | 58.0 | 52.0 | 47.5 | 45.5 | 41.5 | 38.0 | 55.0 |

When Low noise mode is set, the A/C system's capacity is limited. The system could return to normal operation from Low noise mode automatically in the case that the operation condition is severe.

Sound level of PUHY-P950YSNW-A1(-BS)

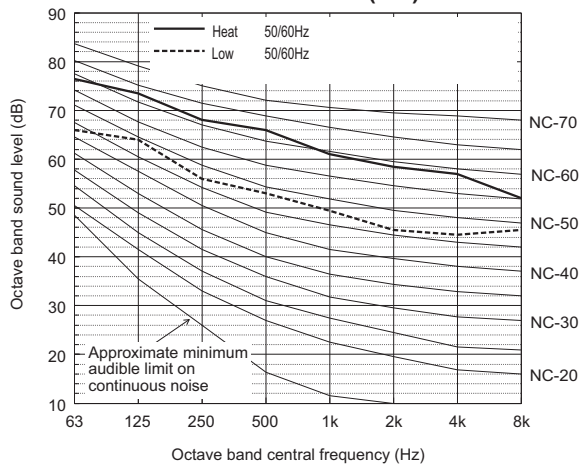

| | | 63 | 125 | 250 | 500 | 1k | 2k | 4k | 8k | dB(A) |
|------------------|---------|------|------|------|------|------|------|------|------|-------|
| Standard Heating | 50/60Hz | 76.5 | 73.5 | 68.0 | 66.0 | 61.0 | 58.5 | 57.0 | 52.0 | 68.0 |
| Low noise mode | 50/60Hz | 66.0 | 64.0 | 56.0 | 53.0 | 49.5 | 45.5 | 44.5 | 45.5 | 56.0 |

When Low noise mode is set, the A/C system's capacity is limited. The system could return to normal operation from Low noise mode automatically in the case that the operation condition is severe.

Sound level of PUHY-P1000YSNW-A1(-BS)

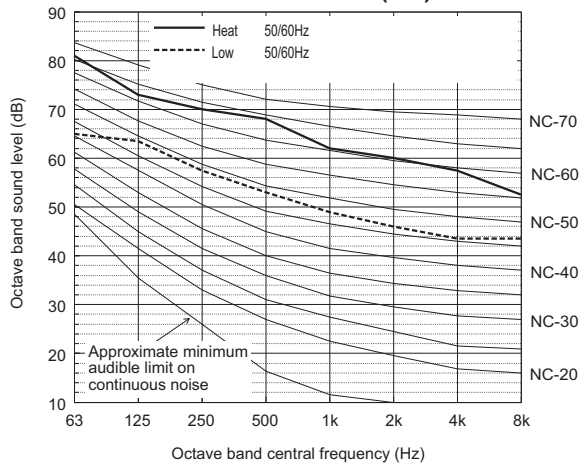

| | | 63 | 125 | 250 | 500 | 1k | 2k | 4k | 8k | dB(A) |
|------------------|---------|------|------|------|------|------|------|------|------|-------|
| Standard Heating | 50/60Hz | 81.0 | 73.0 | 70.0 | 68.0 | 62.0 | 60.0 | 57.5 | 52.5 | 69.5 |
| Low noise mode | 50/60Hz | 65.0 | 63.5 | 57.5 | 53.0 | 49.0 | 46.0 | 43.5 | 43.5 | 56.0 |

When Low noise mode is set, the A/C system's capacity is limited. The system could return to normal operation from Low noise mode automatically in the case that the operation condition is severe.

- Depending on the operation conditions, the unit generates noise caused by valve actuation, refrigerant flow, and pressure changes when operating normally. Please consider to avoid location where quietness is required. The sound pressure level measured by the conventional method in JIS for reference purpose.

PUHY-P-Y(S)NW-A1

Measurement condition
PUHY-P1100, 1150, 1200, 1250, 1300, 1350YSNW-A1(-BS)

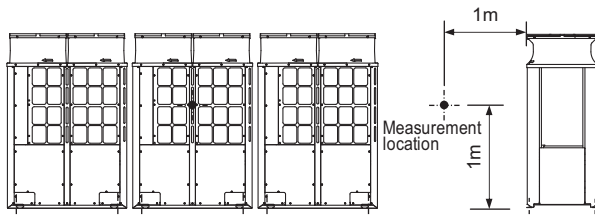

Sound level of PUHY-P1200YSNW-A1(-BS)

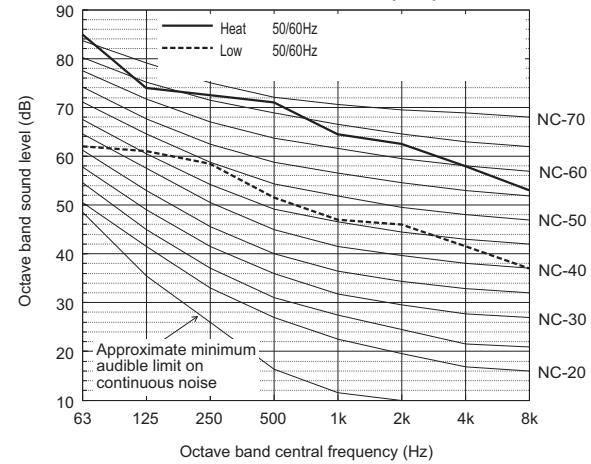

| | | 63 | 125 | 250 | 500 | 1k | 2k | 4k | 8k | dB(A) |
|------------------|---------|------|------|------|------|------|------|------|------|-------|
| Standard Heating | 50/60Hz | 85.0 | 74.0 | 72.5 | 71.0 | 64.5 | 62.5 | 58.0 | 53.0 | 72.0 |
| Low noise mode | 50/60Hz | 62.0 | 61.0 | 58.5 | 51.5 | 47.0 | 46.0 | 41.5 | 37.0 | 55.0 |

When Low noise mode is set, the A/C system's capacity is limited. The system could return to normal operation from Low noise mode automatically in the case that the operation condition is severe.

Sound level of PUHY-P1100YSNW-A1(-BS)

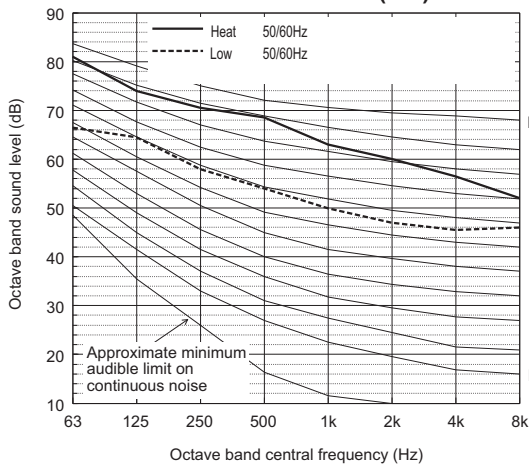

| | | 63 | 125 | 250 | 500 | 1k | 2k | 4k | 8k | dB(A) |
|------------------|---------|------|------|------|------|------|------|------|------|-------|
| Standard Heating | 50/60Hz | 81.0 | 74.0 | 70.5 | 68.5 | 63.0 | 60.0 | 56.5 | 52.0 | 70.0 |
| Low noise mode | 50/60Hz | 66.5 | 64.5 | 58.0 | 54.0 | 50.0 | 47.0 | 45.5 | 46.0 | 57.0 |

When Low noise mode is set, the A/C system's capacity is limited. The system could return to normal operation from Low noise mode automatically in the case that the operation condition is severe.

Sound level of PUHY-P1250YSNW-A1(-BS)

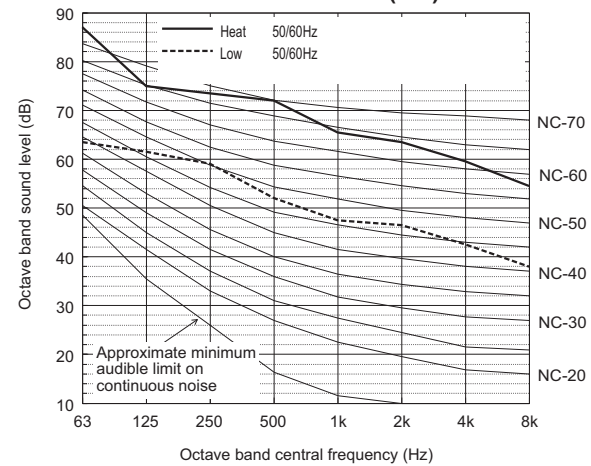

| | | 63 | 125 | 250 | 500 | 1k | 2k | 4k | 8k | dB(A) |
|------------------|---------|------|------|------|------|------|------|------|------|-------|
| Standard Heating | 50/60Hz | 87.0 | 75.0 | 73.5 | 72.0 | 65.5 | 63.5 | 59.5 | 54.5 | 73.0 |
| Low noise mode | 50/60Hz | 63.5 | 61.5 | 59.0 | 52.0 | 47.5 | 46.5 | 42.5 | 38.0 | 55.5 |

When Low noise mode is set, the A/C system's capacity is limited. The system could return to normal operation from Low noise mode automatically in the case that the operation condition is severe.

Sound level of PUHY-P1150YSNW-A1(-BS)

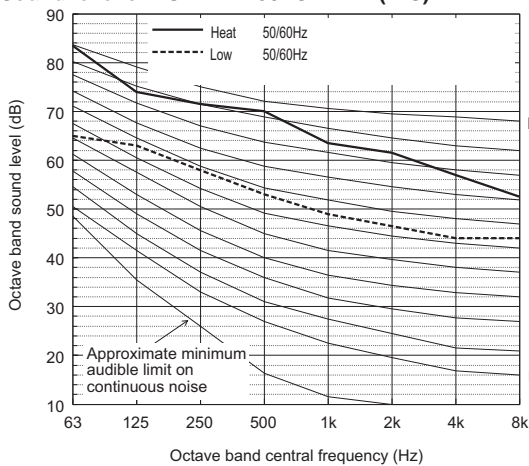

| | | 63 | 125 | 250 | 500 | 1k | 2k | 4k | 8k | dB(A) |
|------------------|---------|------|------|------|------|------|------|------|------|-------|
| Standard Heating | 50/60Hz | 83.5 | 74.0 | 71.5 | 70.0 | 63.5 | 61.5 | 57.0 | 52.5 | 71.0 |
| Low noise mode | 50/60Hz | 65.0 | 63.0 | 58.0 | 53.0 | 49.0 | 46.5 | 44.0 | 44.0 | 56.5 |

When Low noise mode is set, the A/C system's capacity is limited. The system could return to normal operation from Low noise mode automatically in the case that the operation condition is severe.

Sound level of PUHY-P1300YSNW-A1(-BS)

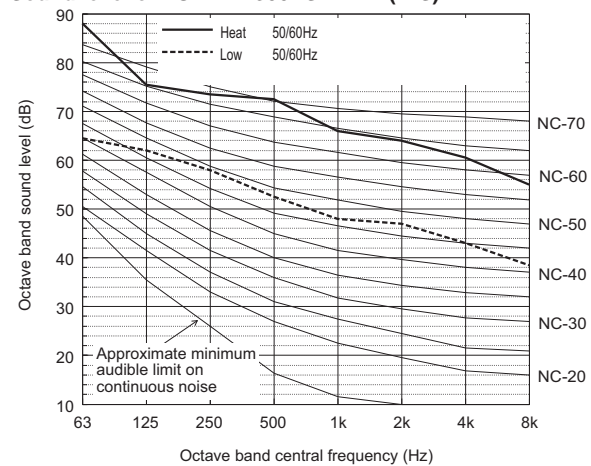

| | | 63 | 125 | 250 | 500 | 1k | 2k | 4k | 8k | dB(A) |
|------------------|---------|------|------|------|------|------|------|------|------|-------|
| Standard Heating | 50/60Hz | 88.0 | 75.5 | 73.5 | 72.5 | 66.0 | 64.0 | 60.5 | 55.0 | 73.5 |
| Low noise mode | 50/60Hz | 64.5 | 62.0 | 58.0 | 52.5 | 48.0 | 47.0 | 43.0 | 38.5 | 56.0 |

When Low noise mode is set, the A/C system's capacity is limited. The system could return to normal operation from Low noise mode automatically in the case that the operation condition is severe.

• Depending on the operation conditions, the unit generates noise caused by valve actuation, refrigerant flow, and pressure changes when operating normally. Please consider to avoid location where quietness is required.
 The sound pressure level measured by the conventional method in JIS for reference purpose.

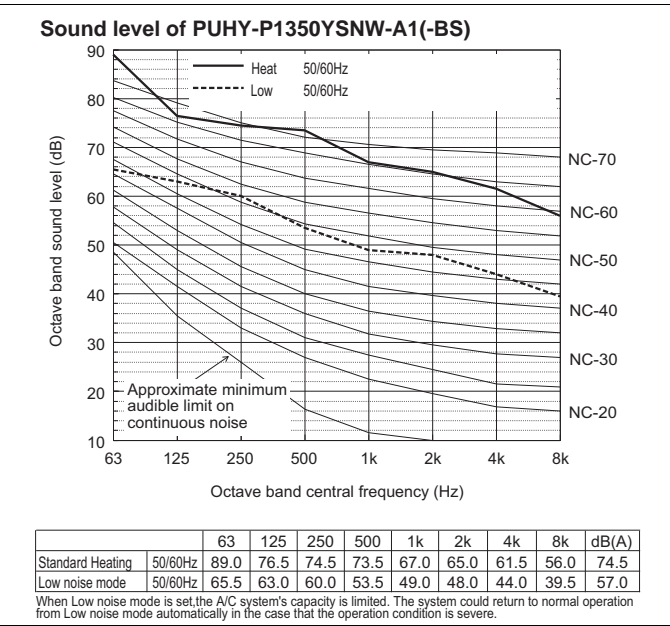

PUHY-P-Y(S)NW-A1

- Depending on the operation conditions, the unit generates noise caused by valve actuation, refrigerant flow, and pressure changes when operating normally. Please consider to avoid location where quietness is required. The sound pressure level measured by the conventional method in JIS for reference purpose.

[PUHY-P200-500YNW-A1, PUHY-P400-1350YSNW-A1]

Measurement condition

Measurement frequency: 1 Hz-80 Hz

Measurement point: Ground surface 20 cm away from the unit leg

Installation condition: Direct installation on the concrete floor

Power source: 3-phase 4-wire 380-400-415 V 50/60 Hz

Operation condition: JIS condition (cooling, heating)

Measurement device: Vibration level meter for vibration pollution VM-1220C (JIS-compliant product)

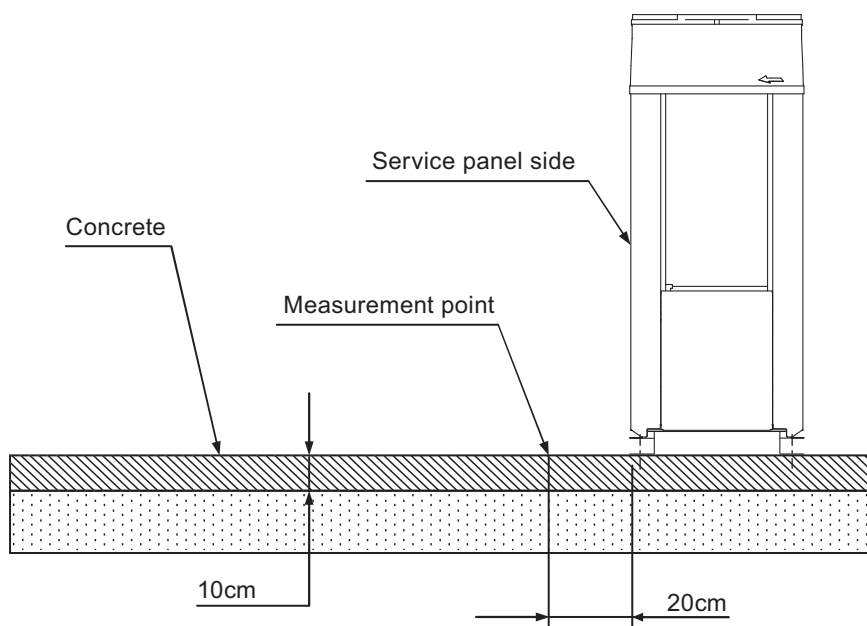

Vibration level

| Model | Vibration level (dB) |
|-------------------------|----------------------|
| PUHY-P200YNW-A1 (-BS) | 45 |
| PUHY-P250YNW-A1 (-BS) | 46 |
| PUHY-P300YNW-A1 (-BS) | 47 |
| PUHY-P350YNW-A1 (-BS) | 47 |
| PUHY-P400YNW-A1 (-BS) | 47 |
| PUHY-P450YNW-A1 (-BS) | 47 |
| PUHY-P500YNW-A1 (-BS) | 48 |
| PUHY-P400YSNW-A1 (-BS) | 48 |
| PUHY-P450YSNW-A1 (-BS) | 48.5 |
| PUHY-P500YSNW-A1 (-BS) | 49 |
| PUHY-P550YSNW-A1 (-BS) | 49.5 |
| PUHY-P600YSNW-A1 (-BS) | 50 |
| PUHY-P650YSNW-A1 (-BS) | 49.5 |
| PUHY-P700YSNW-A1 (-BS) | 50 |
| PUHY-P750YSNW-A1 (-BS) | 50 |
| PUHY-P800YSNW-A1 (-BS) | 50 |
| PUHY-P850YSNW-A1 (-BS) | 50 |
| PUHY-P900YSNW-A1 (-BS) | 50 |
| PUHY-P950YSNW-A1 (-BS) | 51.5 |
| PUHY-P1000YSNW-A1 (-BS) | 51.5 |
| PUHY-P1050YSNW-A1 (-BS) | 51.5 |
| PUHY-P1100YSNW-A1 (-BS) | 52 |
| PUHY-P1150YSNW-A1 (-BS) | 52 |
| PUHY-P1200YSNW-A1 (-BS) | 52 |
| PUHY-P1250YSNW-A1 (-BS) | 52 |
| PUHY-P1300YSNW-A1 (-BS) | 52 |
| PUHY-P1350YSNW-A1 (-BS) | 52 |

* Vibration level varies depending on the conditions of actual installation site.

• Cooling

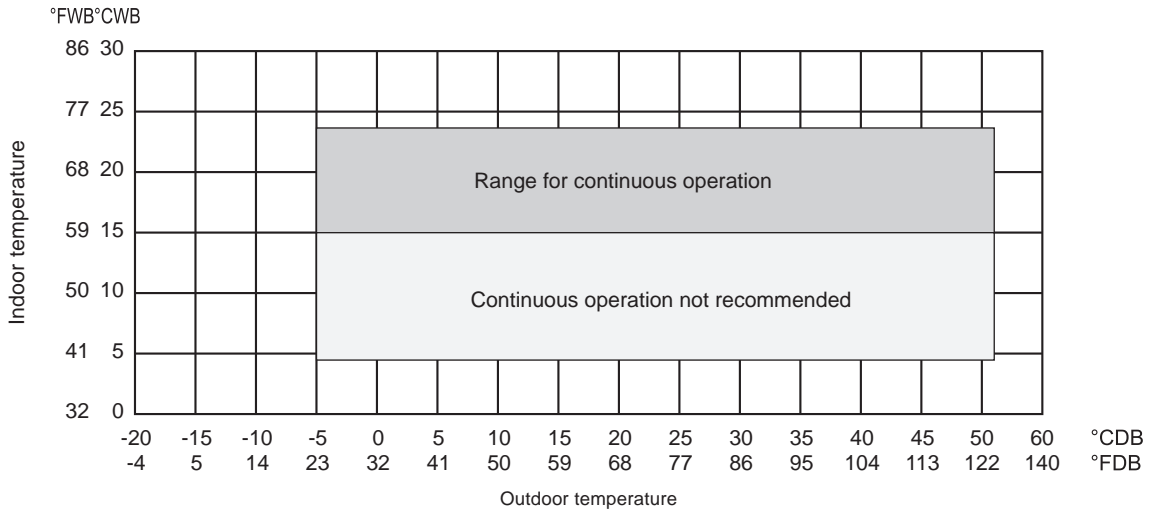

• Heating

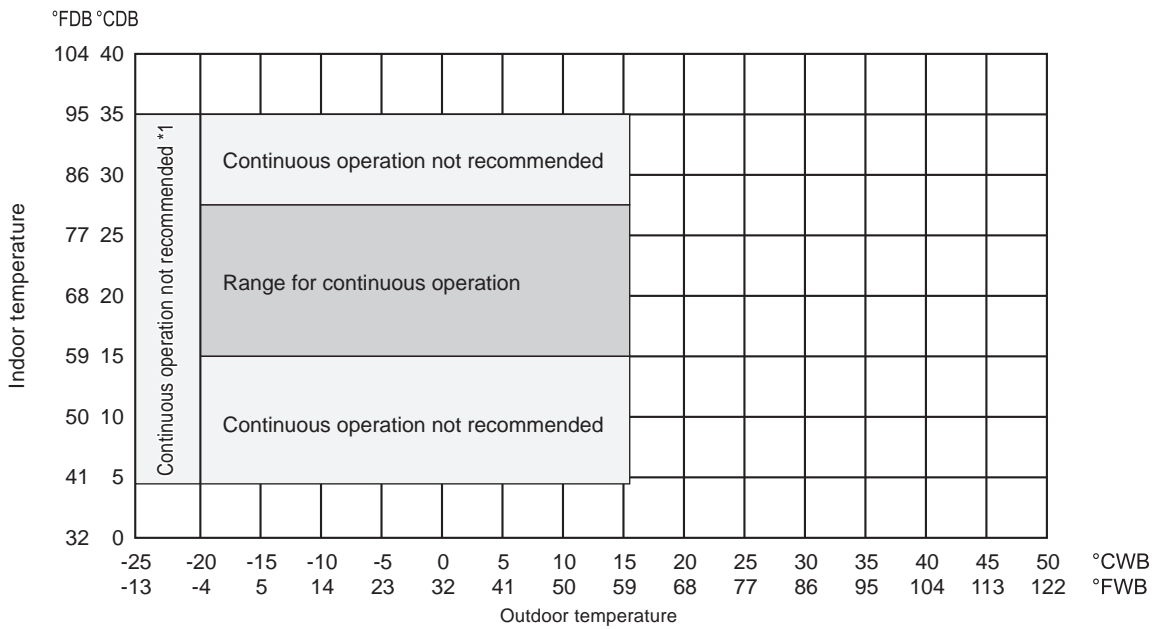

*1 When applying product below -20°CWB, consult your design engineer for cold climate application best practices, including the use of a backup source for heating.

8-1. Selection of Cooling/Heating Units

How to determine the capacity when less than or equal 100% indoor model size units are connected in total:

The purpose of this flow chart is to select the indoor and outdoor units. For other purposes, this flow chart is intended only for reference.

PUHY-P-Y(S)NW-A1

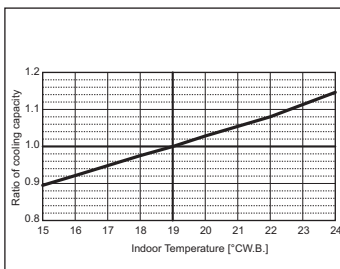
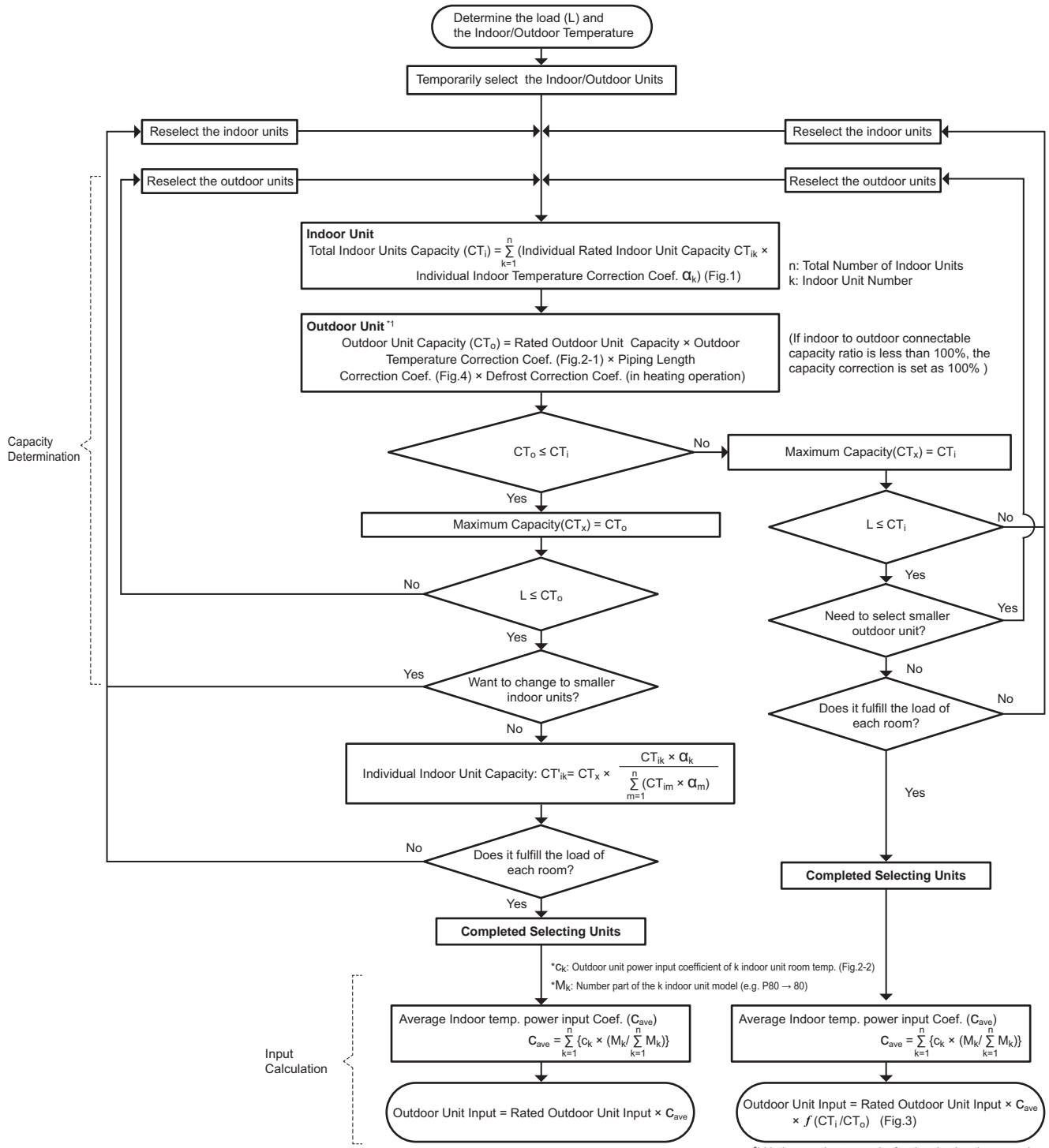

Fig.1 Indoor unit temperature correction

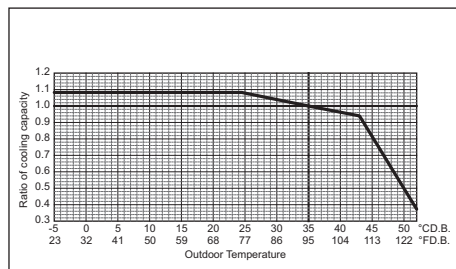

Fig.2-1 Outdoor unit temperature correction (capacity)

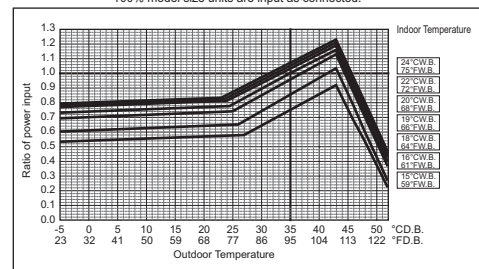

Fig.2-2 Outdoor unit temperature correction (power input)

*1 When the indoor unit sizes from P100 to P140 or total capacity indoor units from P81 to P140 are connected to only 1 port on the BC controller in the R2 system, the cooling capacity of the indoor unit should be multiplied by a correction factor of 0.97.

How to determine the capacity when greater than 100% indoor model size units are connected in total:

The purpose of this flow chart is to select the indoor and outdoor units. For other purposes, this flow chart is intended only for reference.

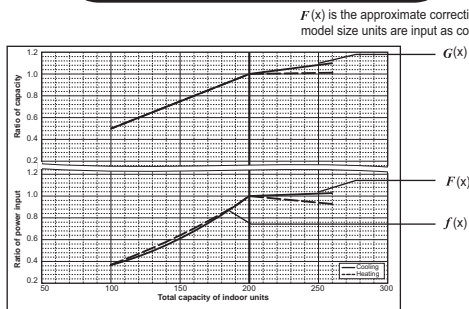
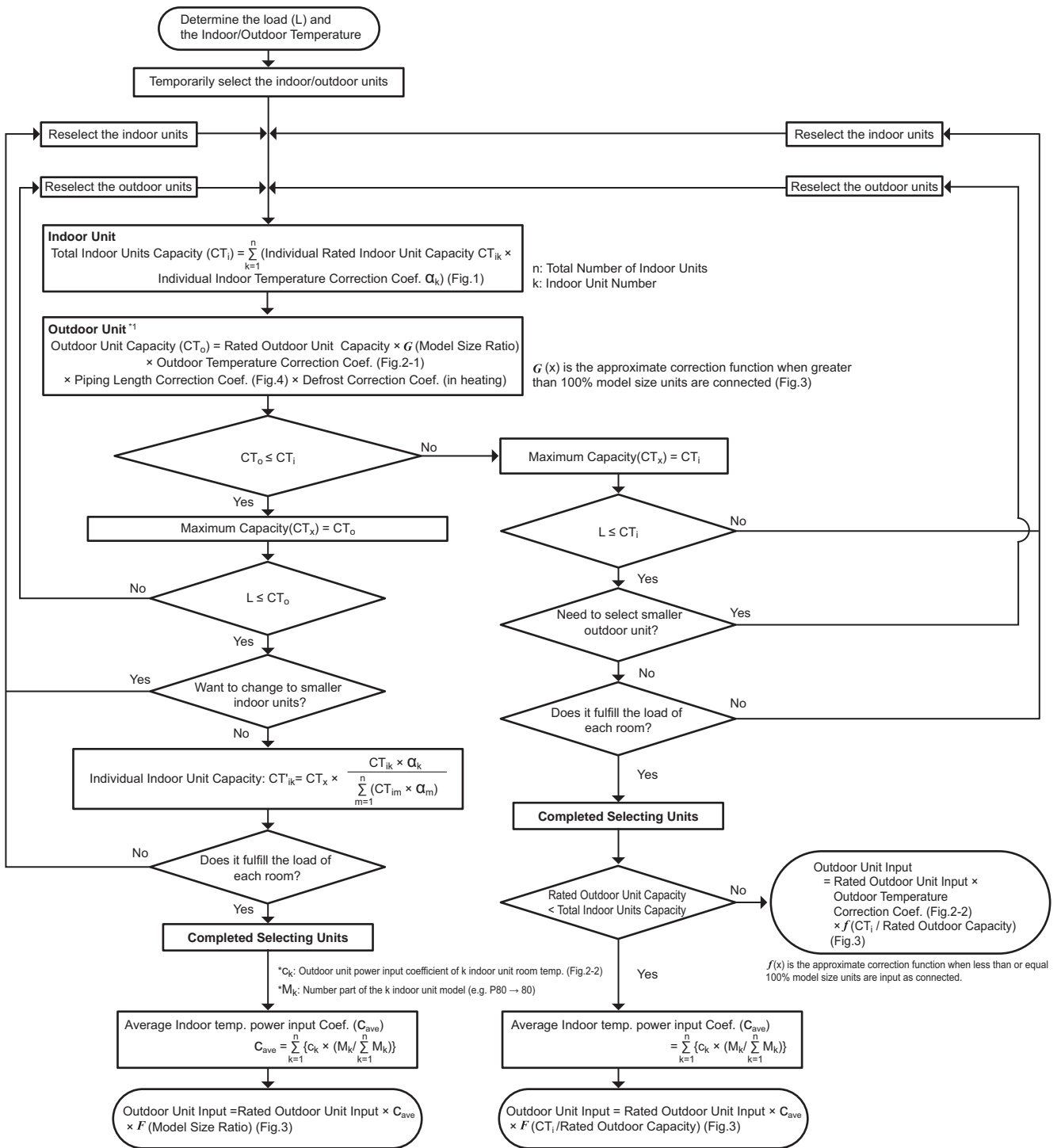

Fig.3 Correction by total indoor

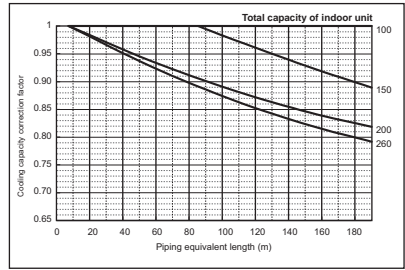

Fig.4 Correction of refrigerant piping length

*1 When the indoor unit sizes from P100 to P140 or total capacity indoor units from P81 to P140 are connected to only 1 port on the BC controller in the R2 system, the cooling capacity of the indoor unit should be multiplied by a correction factor of 0.97.

PUHY-P-Y(S)NW-A1

<Cooling>

| Design Condition | |
|-----------------------------------------|---------|
| Outdoor Design Dry Bulb Temperature | 37 °C |
| Total Cooling Load | 19.0 kW |
| Room1 | |
| Indoor Design Dry Bulb Temperature | 27 °C |
| Indoor Design Wet Bulb Temperature | 20 °C |
| Cooling Load | 9.0 kW |
| Room2 | |
| Indoor Design Dry Bulb Temperature | 24 °C |
| Indoor Design Wet Bulb Temperature | 18 °C |
| Cooling Load | 10.0 kW |
| <Other> | |
| Indoor/Outdoor Equivalent Piping Length | 50 m |

1. Cooling Calculation

(1) Temporary Selection of Indoor Units

| | | |
|-------|-----------|-----------------|
| Room1 | PLFY-P100 | 11.2 kW (Rated) |
| Room2 | PEFY-P100 | 11.2 kW (Rated) |

(2) Total Indoor Units Capacity

$$P100 + P100 = P200$$

(3) Selection of Outdoor Unit

The P200 outdoor unit is selected as total indoor units capacity is P200

| | |
|------------|---------|
| PUHY-EP200 | 22.4 kW |
|------------|---------|

(4) Total Indoor Units Capacity Correction Calculation

| | | |
|-------|------------------------------------------------------|-----------------------|
| Room1 | Indoor Design Wet Bulb Temperature Correction (20°C) | 1.03 (Refer to Fig.1) |
| Room2 | Indoor Design Wet Bulb Temperature Correction (18°C) | 0.98 (Refer to Fig.1) |

Total Indoor Units Capacity (CTi)

$$\begin{aligned}
 CTi &= \Sigma (\text{Indoor Unit Rating} \times \text{Indoor Design Temperature Correction}) \\
 &= 11.2 \times 1.03 + 11.2 \times 0.98 \\
 &= 22.5 \text{ kW}
 \end{aligned}$$

(5) Outdoor Unit Correction Calculation

| | |
|-------------------------------------------------------|-----------------------|
| Outdoor Design Dry Bulb Temperature Correction (37°C) | 0.99 (Refer to Fig.2) |
| Piping Length Correction (50 m) | 0.95 (Refer to Fig.3) |

Total Outdoor Unit Capacity (CTo)

$$\begin{aligned}
 CTo &= \text{Outdoor Rating} \times \text{Outdoor Design Temperature Correction} \times \text{Piping Length Correction} \\
 &= 22.4 \times 0.99 \times 0.95 \\
 &= 21.0 \text{ kW}
 \end{aligned}$$

(6) Determination of Maximum System Capacity (CTx)

Comparison of Capacity between Total Indoor Units Capacity (CTi) and Total Outdoor Unit Capacity (CTo)

$$CTi = 22.5 > CTo = 21.0, \text{ thus, select } CTo.$$

$$CTx = CTo = 21.0 \text{ kW}$$

(7) Comparison with Essential Load

Against the essential load 19.0kW, the maximum system capacity is 21.0kW: Proper outdoor units have been selected.

(8) Calculation of Maximum Indoor Unit Capacity of Each Room

CTx = CTo, thus, calculate by the calculation below

Room1

$$\begin{aligned}
 &\text{Maximum Capacity} \times \text{Room1 Capacity after the Temperature Correction} / (\text{Room1,2 Total Capacity after the Temperature Correction}) \\
 &= 21.0 \times (11.2 \times 1.03) / (11.2 \times 1.03 + 11.2 \times 0.98) \\
 &= 10.8 \text{ kW} \quad \text{OK: fulfills the load 9.0kW}
 \end{aligned}$$

Room2

$$\begin{aligned}
 &\text{Maximum Capacity} \times \text{Room2 Capacity after the Temperature Correction} / (\text{Room1,2 Total Capacity after the Temperature Correction}) \\
 &= 21.0 \times (11.2 \times 0.98) / (11.2 \times 1.03 + 11.2 \times 0.98) \\
 &= 10.2 \text{ kW} \quad \text{OK: fulfills the load 10.0kW}
 \end{aligned}$$

Go on to the heating trial calculation since the selected units fulfill the cooling loads of Room 1, 2.

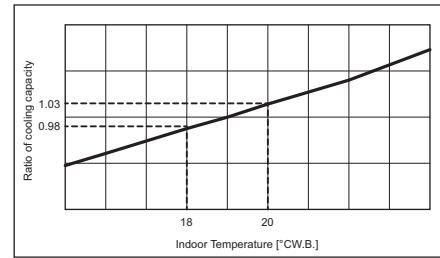

Fig.1 Indoor unit temperature correction

To be used to correct indoor unit only

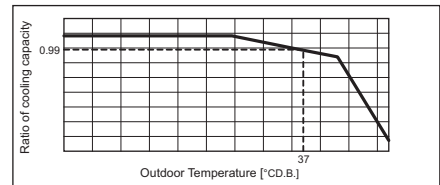

Fig.2 Outdoor unit temperature correction

To be used to correct outdoor unit only

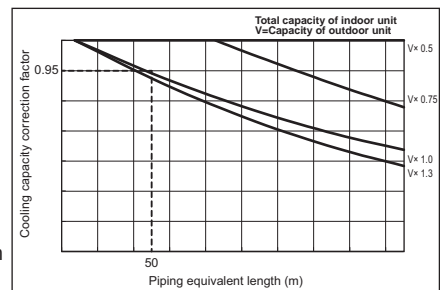

Fig.3 Correction of refrigerant piping length

<Heating>

| Design Condition | |
|-----------------------------------------|---------|
| Outdoor Design Wet Bulb Temperature | -3 °C |
| Total Heating Load | 18.5 kW |
| Room1 | |
| Indoor Design Dry Bulb Temperature | 25 °C |
| Heating Load | 9.5 kW |
| Room2 | |
| Indoor Design Dry Bulb Temperature | 25 °C |
| Heating Load | 9.0 kW |
| <Other> | |
| Indoor/Outdoor Equivalent Piping Length | 50 m |

2. Heating Calculation

(1) Temporary Selection of Indoor Units

| | | |
|-------|-----------|-----------------|
| Room1 | PLFY-P100 | 12.5 kW (Rated) |
| Room2 | PEFY-P100 | 12.5 kW (Rated) |

(2) Total Indoor Units Capacity

P100 + P100 = P200

(3) Selection of Outdoor Unit

The P200 outdoor unit is selected as total indoor units capacity is P200
 PUHY-EP200 **25.0 kW**

(4) Total Indoor Units Capacity Correction Calculation

| | | |
|-------|------------------------------------------------------|-----------------------|
| Room1 | Indoor Design Dry Bulb Temperature Correction (25°C) | 0.80 (Refer to Fig.4) |
| Room2 | Indoor Design Dry Bulb Temperature Correction (25°C) | 0.80 (Refer to Fig.4) |

Total Indoor Units Capacity (CTi)

$$CTi = \sum (\text{Indoor Unit Rating} \times \text{Indoor Design Temperature Correction})$$

$$= 12.5 \times 0.80 + 12.5 \times 0.80$$

$$= 20.0 \text{ kW}$$

(5) Outdoor Unit Correction Calculation

| | |
|-------------------------------------------------------|-----------------------|
| Outdoor Design Wet Bulb Temperature Correction (-3°C) | 0.98 (Refer to Fig.5) |
| Piping Length Correction (60 m) | 0.97 (Refer to Fig.6) |
| Defrost Correction | 0.89 (Refer to Tbl.1) |

Total Outdoor Unit Capacity (CTo)

$$CTo = \text{Outdoor Unit Rating} \times \text{Outdoor Design Temperature Correction} \times \text{Piping Length Correction} \times \text{Defrost Correction}$$

$$= 25.0 \times 0.98 \times 0.97 \times 0.89$$

$$= 21.1 \text{ kW}$$

(6) Determination of Maximum System Capacity (CTx)

Comparison of Capacity between Total Indoor Units Capacity (CTi) and Total Outdoor Unit Capacity (CTo)

CTi = 20.0 < CTo = 21.1, thus, select CTi.
 CTx = CTi = 20.0 kW

(7) Comparison with Essential Load

Against the essential load 18.5kW, the maximum system capacity is 20.0kW: Proper outdoor units have been selected.

(8) Calculation of Maximum Indoor Unit Capacity of Each Room

CTx = CTi, thus, calculate by the calculation below

| | | |
|-------|-----------------------------------------------------------|-----------------------------|
| Room1 | Indoor Unit Rating × Indoor Design Temperature Correction | OK: fulfills the load 9.5kW |
| | = 12.5 × 0.80 | |
| | = 10.0 kW | |
| Room2 | Indoor Unit Rating × Indoor Design Temperature Correction | OK: fulfills the load 9.0kW |
| | = 12.5 × 0.80 | |
| | = 10.0 kW | |

Tbl.1 Table of correction factor at frost and defrost

| Outdoor inlet air temp. °CWB | 6 | 4 | 2 | 1 | 0 | -2 | -4 | -6 | -8 | -10 | -20 |
|------------------------------|------|------|------|-------|------|------|------|------|------|------|------|
| Outdoor inlet air temp. °FWB | 43 | 39 | 36 | 34 | 32 | 28 | 25 | 21 | 18 | 14 | -4 |
| PUHY-P200 | 1.00 | 0.95 | 0.84 | 0.825 | 0.83 | 0.87 | 0.90 | 0.95 | 0.95 | 0.95 | 0.95 |
| PUHY-P250 | 1.00 | 0.95 | 0.84 | 0.825 | 0.83 | 0.87 | 0.90 | 0.95 | 0.95 | 0.95 | 0.95 |
| PUHY-P300 | 1.00 | 0.93 | 0.82 | 0.80 | 0.82 | 0.86 | 0.90 | 0.90 | 0.95 | 0.95 | 0.95 |
| PUHY-P350 | 1.00 | 0.93 | 0.85 | 0.83 | 0.84 | 0.86 | 0.90 | 0.90 | 0.95 | 0.95 | 0.95 |
| PUHY-P400 | 1.00 | 0.93 | 0.85 | 0.83 | 0.84 | 0.86 | 0.90 | 0.90 | 0.95 | 0.95 | 0.95 |

Completed selecting units since the selected units fulfill the heating loads of Room 1, 2.

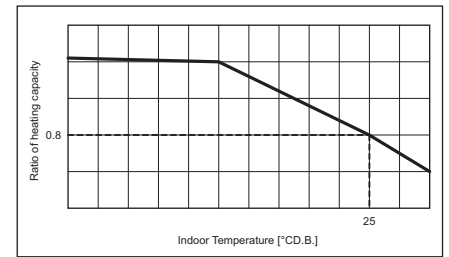

Fig.4 Indoor unit temperature correction
 To be used to correct indoor unit only

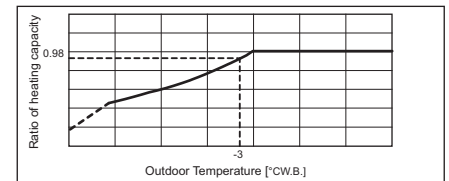

Fig.5 Outdoor unit temperature correction
 To be used to correct outdoor unit only

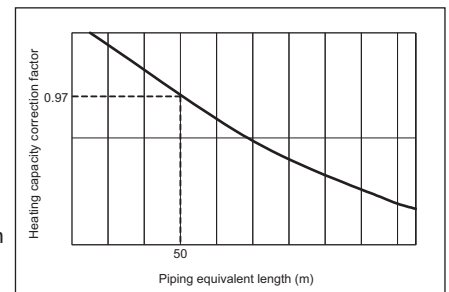

Fig.6 Correction of refrigerant piping length

3. Power input of outdoor unit

<Cooling>

(1) Rated power input of outdoor unit **5.19 kW****(2) Calculation of the average indoor temperature power input coefficient**

Coefficient of the outdoor unit for indoor unit 1 (Outdoor temp. 37 °CD.B., Indoor temp. 20 °CW.B.)

1.07

Coefficient of the outdoor unit for indoor unit 2 (Outdoor temp. 37 °CD.B., Indoor temp. 18 °CW.B.)

1.00

$$\text{Average indoor temp. power input coefficient } (C_{ave}) = \sum_{k=1}^n \{c_k \times (M_k / \sum_{k=1}^n M_k)\}$$

n: Total number of the indoor units

k: Number of the indoor unit

c_k: Outdoor unit power input coefficient of k indoor unit room temp.M_k: Number part of the k indoor unit model (e.g. P80 → 80)

$$= 1.07 \times 100 / (100 + 100) + 1 \times 100 / (100 + 100)$$

$$= 1.04$$

(3) No need to consider Coefficient of the partial load f(CTi/CTo) -**(4) Outdoor power input (P_{lo})**Maximum System Capacity (CT_x) = Total Outdoor unit Capacity (CT_o), so use the following formulaP_{lo} = Outdoor unit Cooling Rated Power Input × Correction Coefficient of Indoor temperature

$$= 5.19 \times 1.04$$

$$= 5.4 \text{ kW}$$

<Heating>

(1) Rated power input of outdoor unit **5.73 kW****(2) Calculation of the average indoor temperature power input coefficient**Coefficient of the outdoor unit for indoor unit 1 (Outdoor temp. -3 °CW.B., Indoor temp. 25 °CD.B.)
1.08Coefficient of the outdoor unit for indoor unit 2 (Outdoor temp. -3 °CW.B., Indoor temp. 25 °CD.B.)
1.08

$$\text{Average indoor temp. power input coefficient } (C_{ave}) = \sum_{k=1}^n \{c_k \times (M_k / \sum_{k=1}^n M_k)\}$$

n: Total number of the indoor units

k: Number of the indoor unit

c_k: Outdoor unit power input coefficient of k indoor unit room temp.M_k: Number part of the k indoor unit model (e.g. P80 → 80)

$$= 1.08 \times 100 / (100 + 100) + 1.08 \times 100 / (100 + 100)$$

$$= 1.08$$

(3) Coefficient of the partial load f (CTi/CTo) **0.91****(4) Outdoor power input (P_{lo})**Maximum System Capacity (CT_x) = Total Indoor unit Capacity (CT_i), so use the following formula

$$P_{lo} = \text{Outdoor unit Heating Rated Power Input} \times \text{Correction Coefficient of Indoor temperature} \times f(\text{CT}_i/\text{CT}_o)$$

$$= 5.73 \times 1.08 \times 0.91$$

$$= 5.65 \text{ kW}$$

8-2. Correction by temperature

CITY MULTI could have varied capacity at different designing temperature. Using the nominal cooling/heating capacity value and the ratio below, the capacity can be observed at various temperature.

PUHY-P-Y(S)NW-A1

| PUHY- | | P200YNW-A1 | P250YNW-A1 |
|------------------|-------|------------|------------|
| Cooling Capacity | kW | 22.4 | 28.0 |
| | BTU/h | 76,400 | 95,500 |
| Input | kW | 4.81 | 7.14 |

Indoor unit temperature correction

To be used to correct indoor unit capacity only

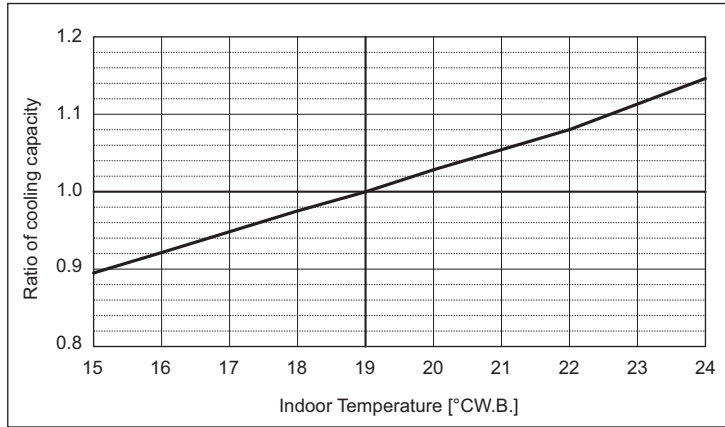

Outdoor unit temperature correction

To be used to correct outdoor unit only

Outdoor unit capacity is NOT affected by the indoor temperature.

Outdoor unit power input is affected by the indoor and outdoor temperatures. Please consult the sales office for details.

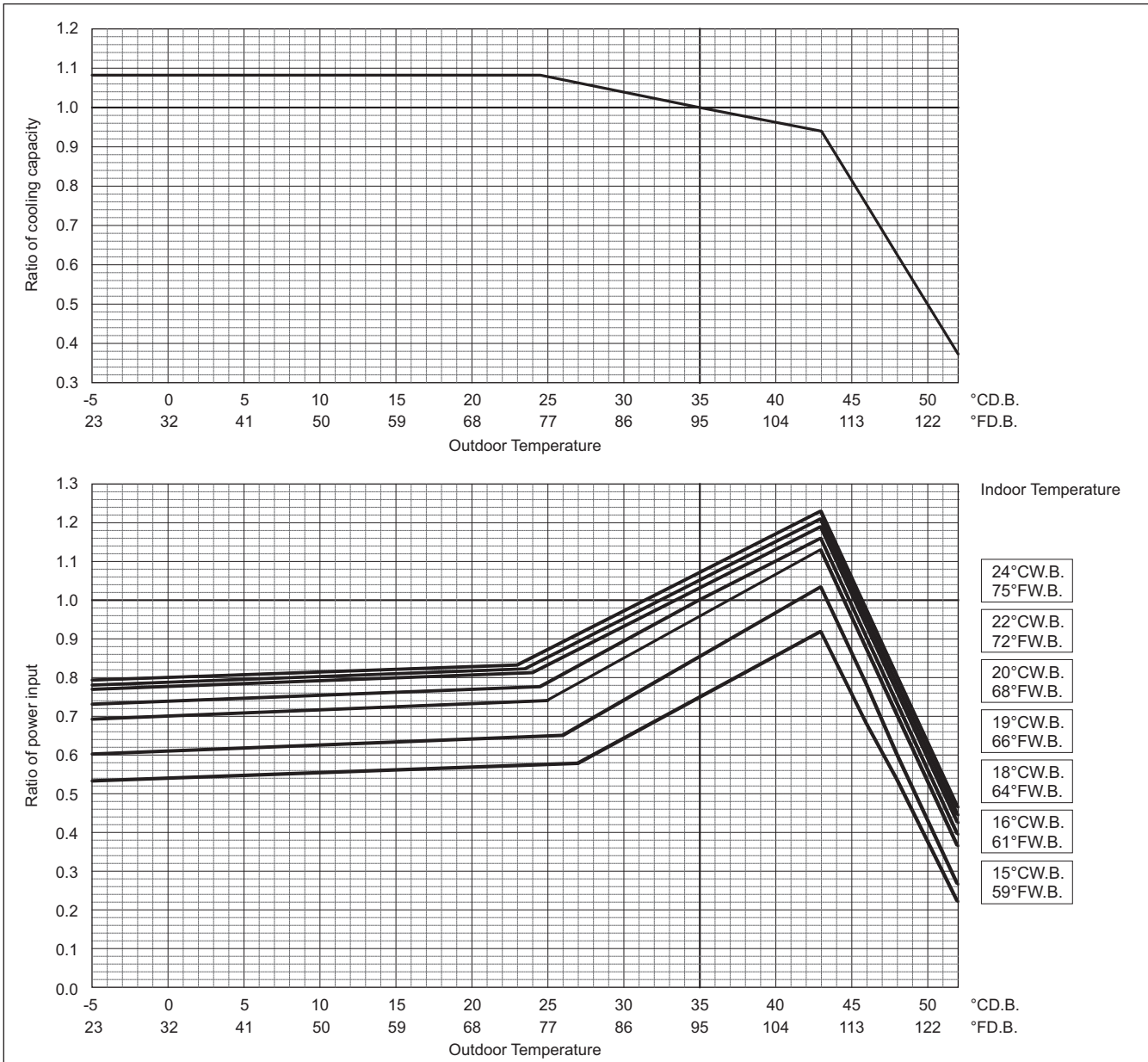

| | PUHY- | P200YNW-A1 | P250YNW-A1 |
|------------------|-------|------------|------------|
| Heating Capacity | kW | 25.0 | 31.5 |
| | BTU/h | 85,300 | 107,500 |
| Input | kW | 5.10 | 7.20 |

Indoor unit temperature correction

To be used to correct indoor unit capacity only

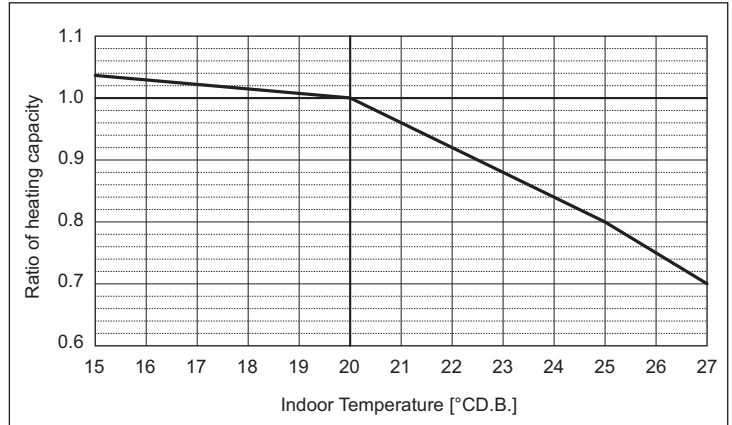

Outdoor unit temperature correction

To be used to correct outdoor unit only

Outdoor unit capacity is NOT affected by the indoor temperature.

Outdoor unit power input is affected by the indoor and outdoor temperatures. Please consult the sales office for details.

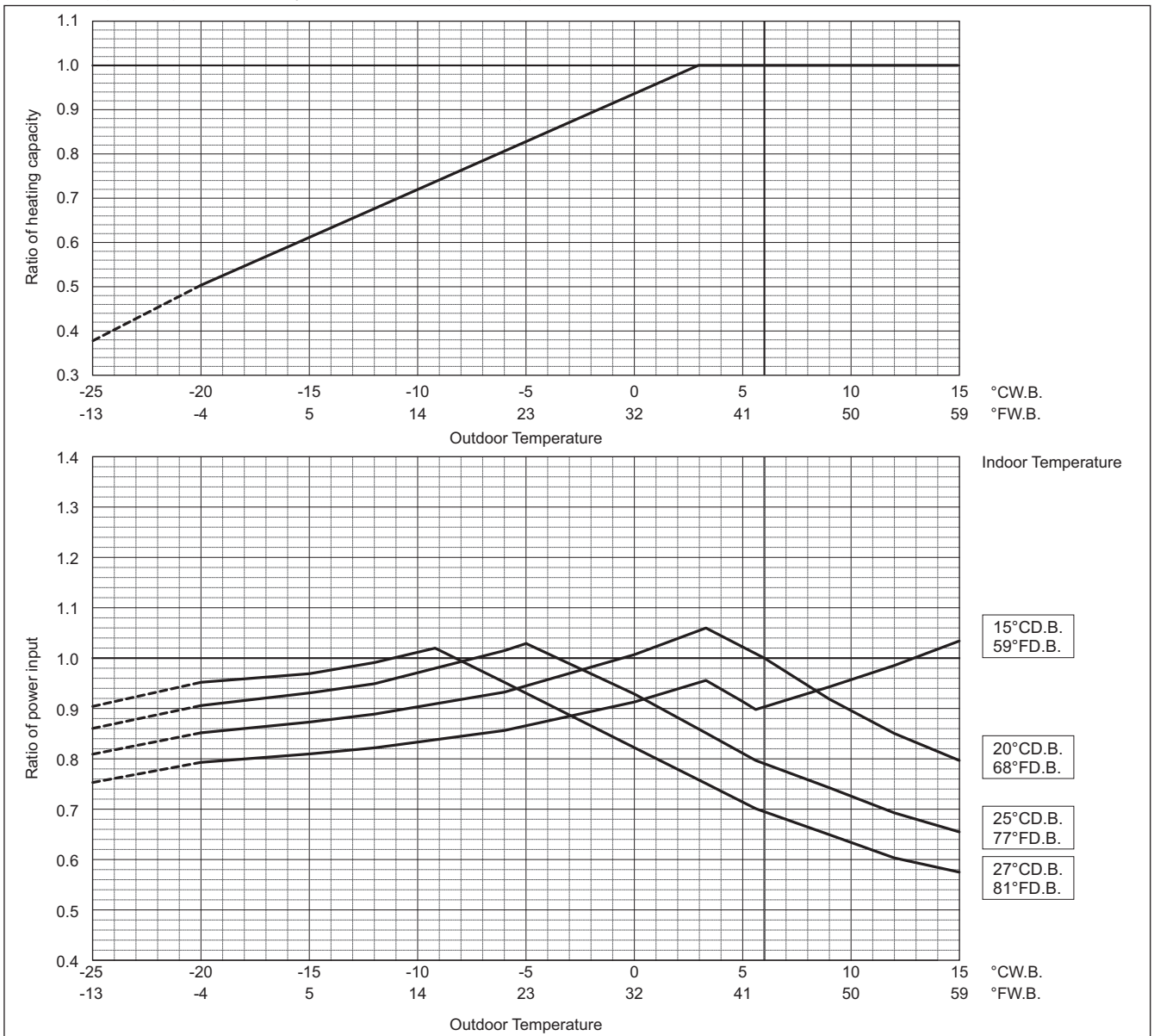

Values in the heating temperature correction diagram in the range below -20°C (-4°F) are reference values and not guaranteed values. Do not use these reference values for selecting outdoor unit models.

When applying product below -20°C (-4°F), consult your design engineer for cold climate application best practices, including the use of a backup source for heating.

| PUHY- | P300YNW-A1 | P350YNW-A1 |
|---------------------|------------|------------|
| Cooling Capacity kW | 33.5 | 40.0 |
| BTU/h | 114,300 | 136,500 |
| Input kW | 8.79 | 10.95 |

Indoor unit temperature correction
To be used to correct indoor unit capacity only

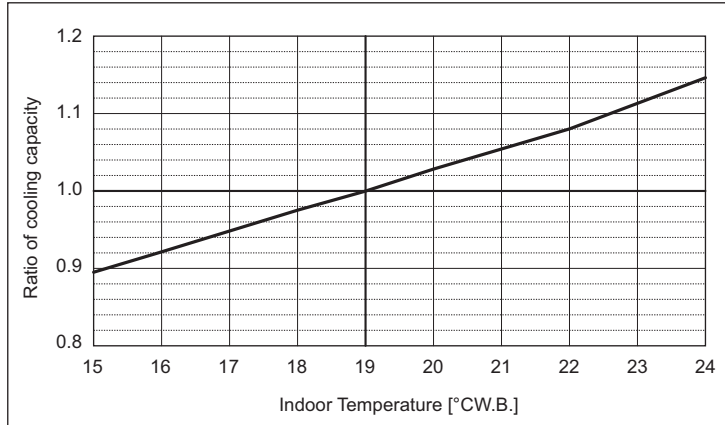

Outdoor unit temperature correction

To be used to correct outdoor unit only

Outdoor unit capacity is NOT affected by the indoor temperature.

Outdoor unit power input is affected by the indoor and outdoor temperatures. Please consult the sales office for details.

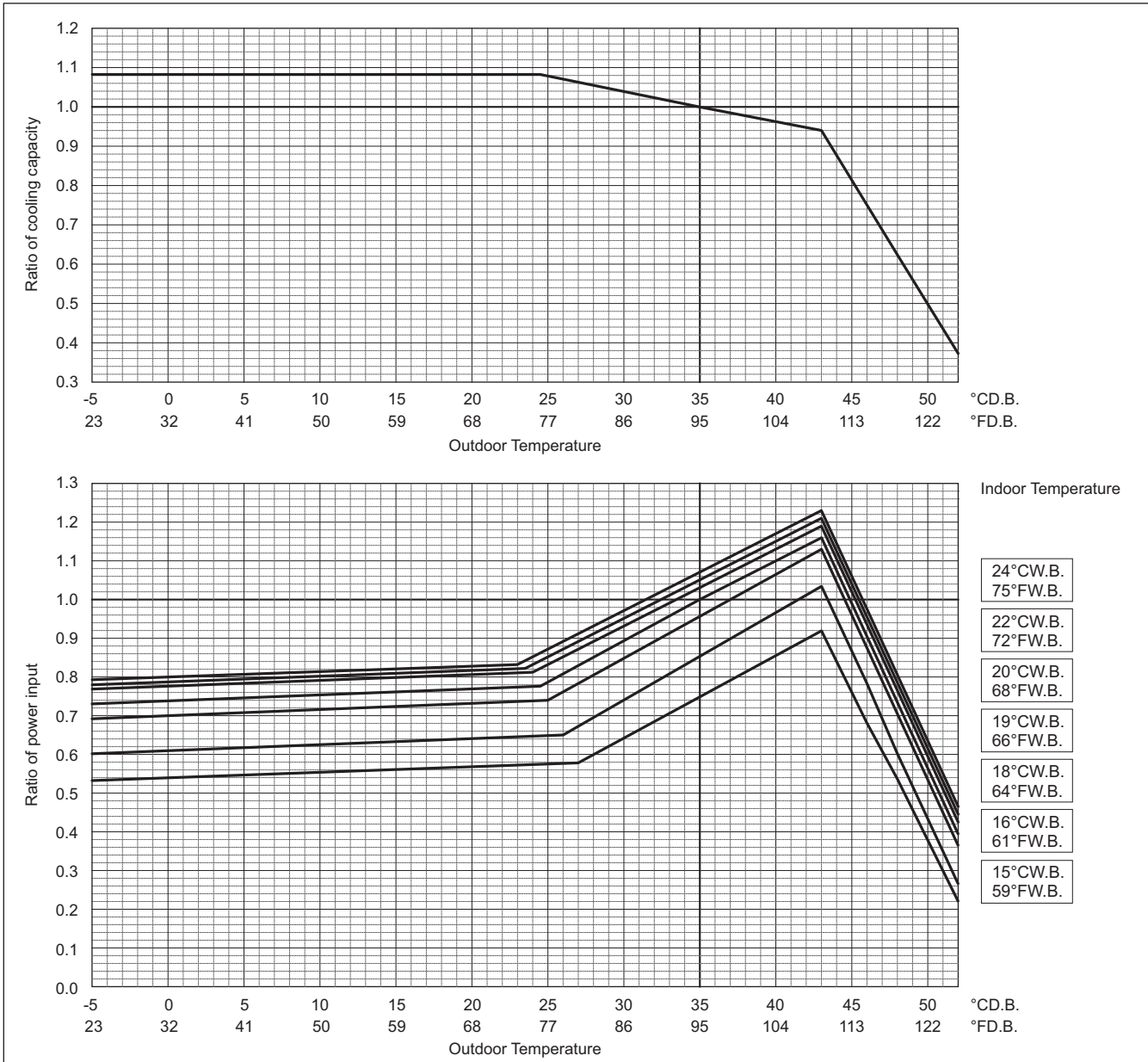

PUHY-P-Y(S)NW-A1

| | PUHY- | P300YNW-A1 | P350YNW-A1 |
|------------------|-------|------------|------------|
| Heating Capacity | kW | 37.5 | 45.0 |
| | BTU/h | 128,000 | 153,500 |
| Input | kW | 8.46 | 10.39 |

Indoor unit temperature correction

To be used to correct indoor unit capacity only

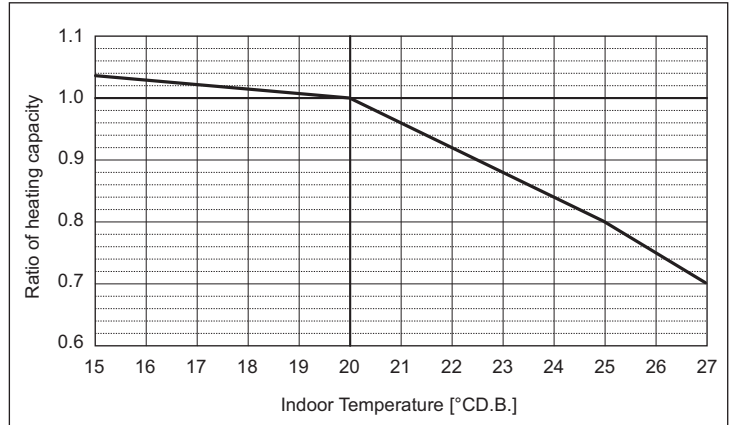

Outdoor unit temperature correction

To be used to correct outdoor unit only

Outdoor unit capacity is NOT affected by the indoor temperature.

Outdoor unit power input is affected by the indoor and outdoor temperatures. Please consult the sales office for details.

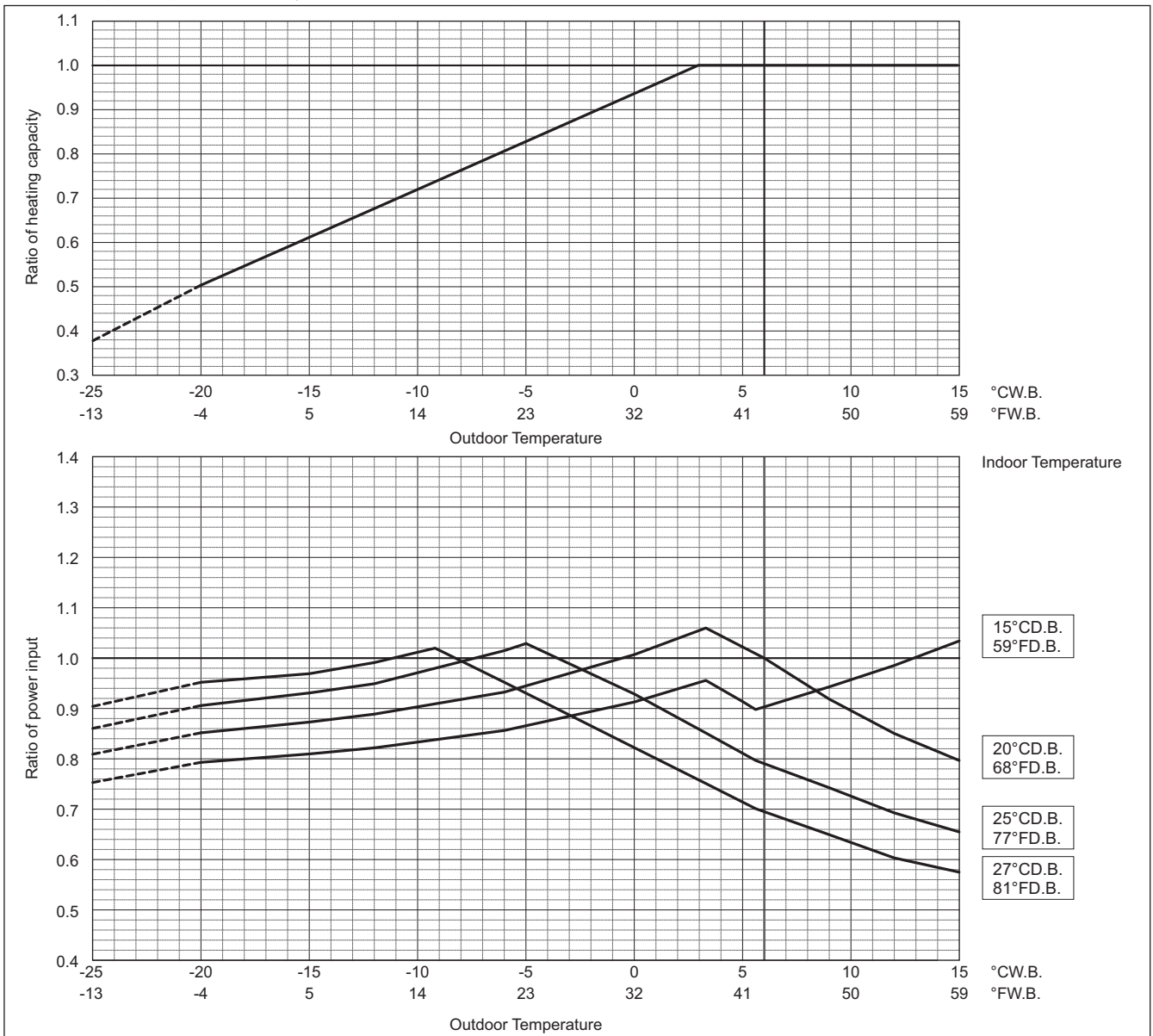

Values in the heating temperature correction diagram in the range below -20°C (-4°F) are reference values and not guaranteed values. Do not use these reference values for selecting outdoor unit models.

When applying product below -20°C (-4°F), consult your design engineer for cold climate application best practices, including the use of a backup source for heating.

PUHY-P-Y(S)NW-A1

PUHY-P-Y(S)NW-A1

| PUHY- | | P400YNW-A1 | P450YNW-A1 | P500YNW-A1 |
|------------------|-------|------------|------------|------------|
| Cooling Capacity | kW | 45.0 | 50.0 | 56.0 |
| | BTU/h | 153,500 | 170,600 | 191,100 |
| Input | kW | 14.19 | 14.57 | 17.55 |

Indoor unit temperature correction
To be used to correct indoor unit capacity only

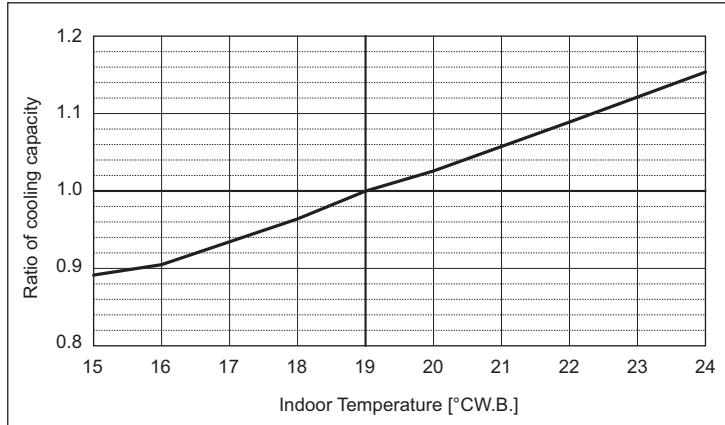

Outdoor unit temperature correction

To be used to correct outdoor unit only

Outdoor unit capacity is NOT affected by the indoor temperature.

Outdoor unit power input is affected by the indoor and outdoor temperatures. Please consult the sales office for details.

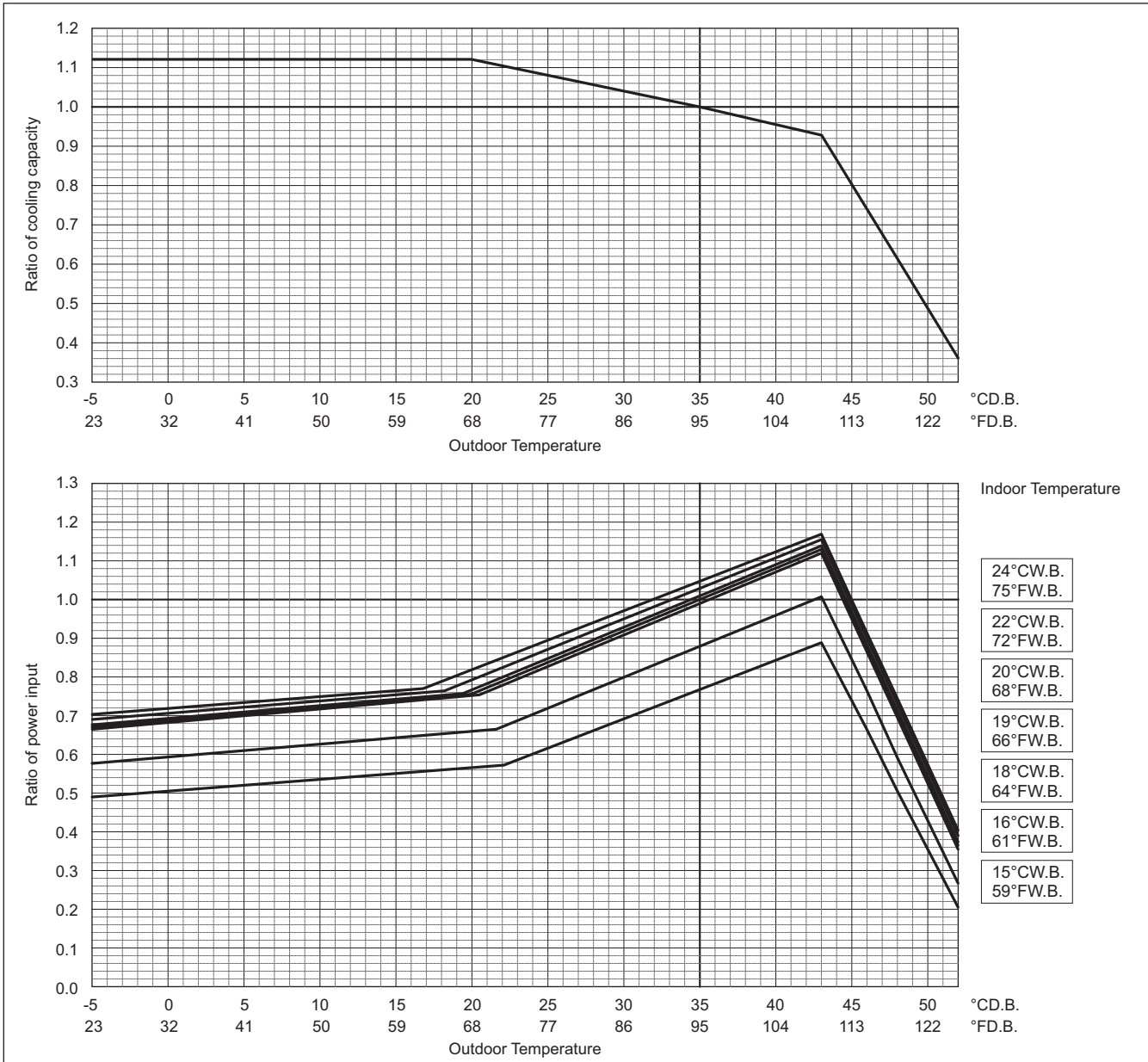

| PUHY- | P400YNW-A1 | P450YNW-A1 | P500YNW-A1 |
|------------------|---------------|------------|------------|
| Heating Capacity | kW 50.0 | 56.0 | 63.0 |
| | BTU/h 170,600 | 191,100 | 215,000 |
| Input | kW 12.37 | 14.00 | 15.98 |

Indoor unit temperature correction
To be used to correct indoor unit capacity only

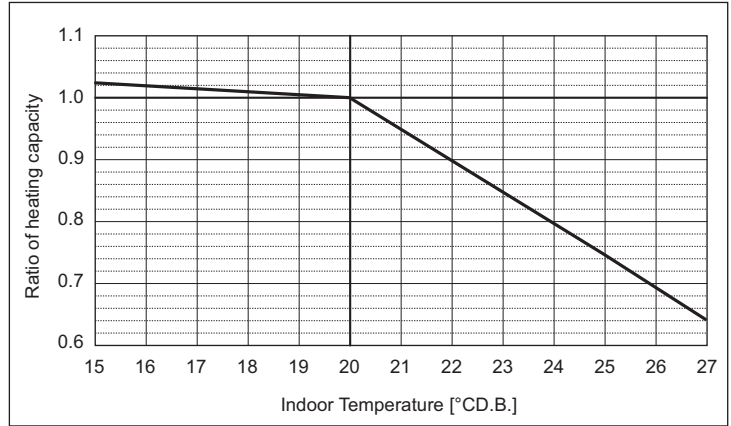

Outdoor unit temperature correction

To be used to correct outdoor unit only

Outdoor unit capacity is NOT affected by the indoor temperature.

Outdoor unit power input is affected by the indoor and outdoor temperatures. Please consult the sales office for details.

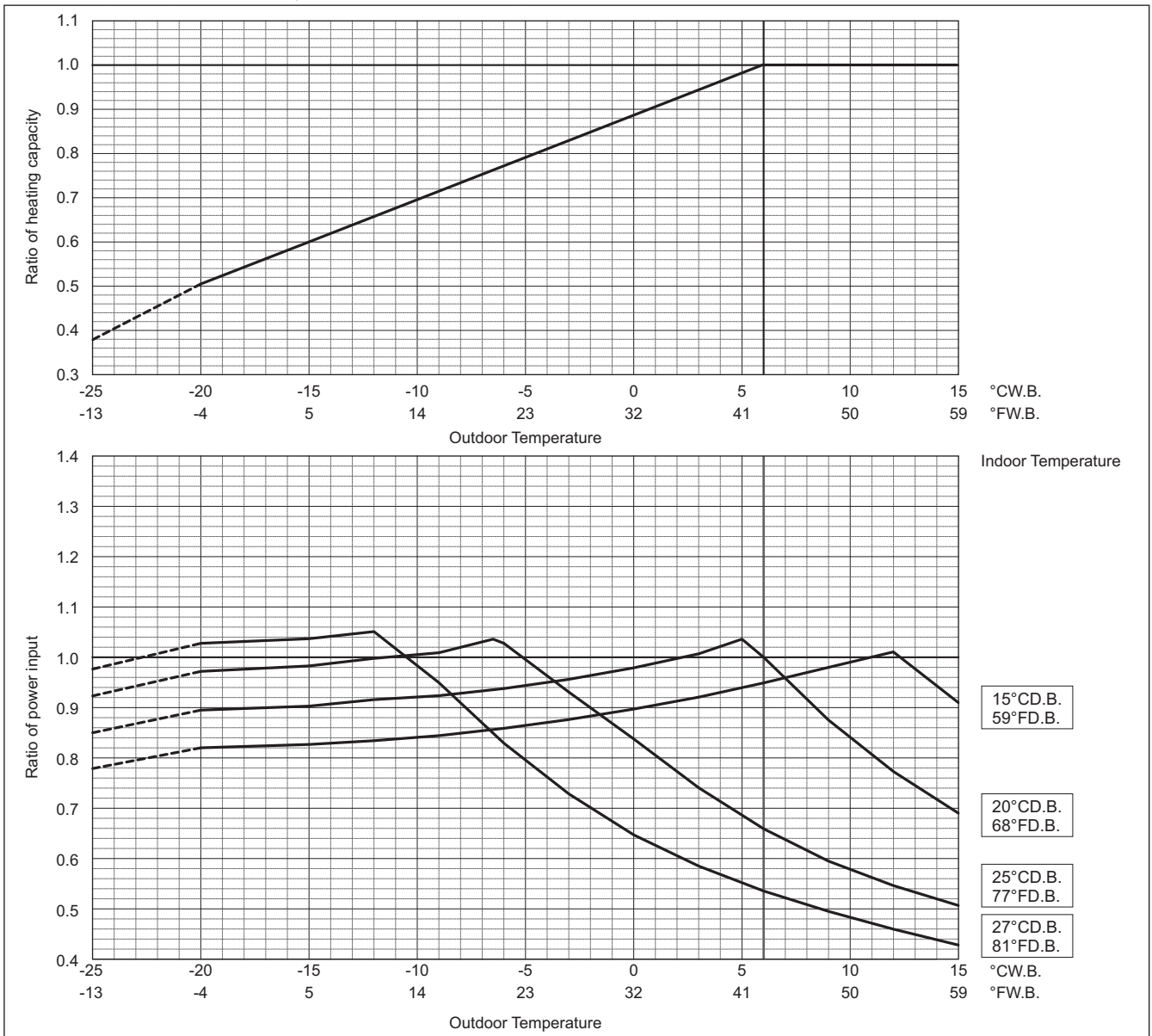

Values in the heating temperature correction diagram in the range below -20°C (-4°F) are reference values and not guaranteed values. Do not use these reference values for selecting outdoor unit models.

When applying product below -20°C (-4°F), consult your design engineer for cold climate application best practices, including the use of a backup source for heating.

PUHY-P-Y(S)NW-A1

| PUHY- | | P400YSNW-A1 | P450YSNW-A1 | P500YSNW-A1 |
|------------------|-------|-------------|-------------|-------------|
| Cooling Capacity | kW | 45.0 | 50.0 | 56.0 |
| | BTU/h | 153,500 | 170,600 | 191,100 |
| Input | kW | 9.97 | 12.16 | 14.73 |

Indoor unit temperature correction
To be used to correct indoor unit capacity only

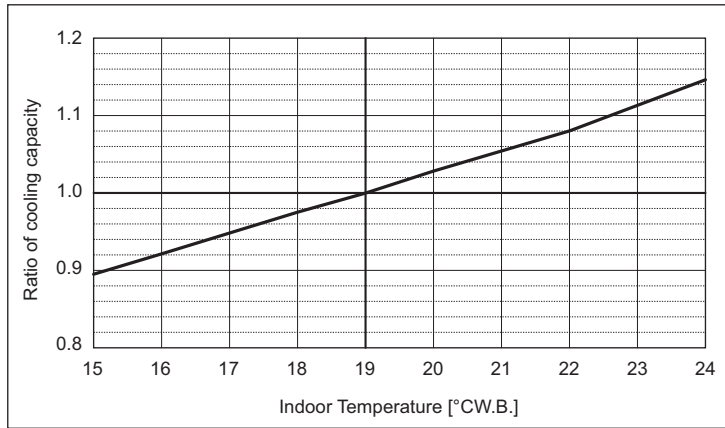

Outdoor unit temperature correction

To be used to correct outdoor unit only
Outdoor unit capacity is NOT affected by the indoor temperature.
Outdoor unit power input is affected by the indoor and outdoor temperatures. Please consult the sales office for details.

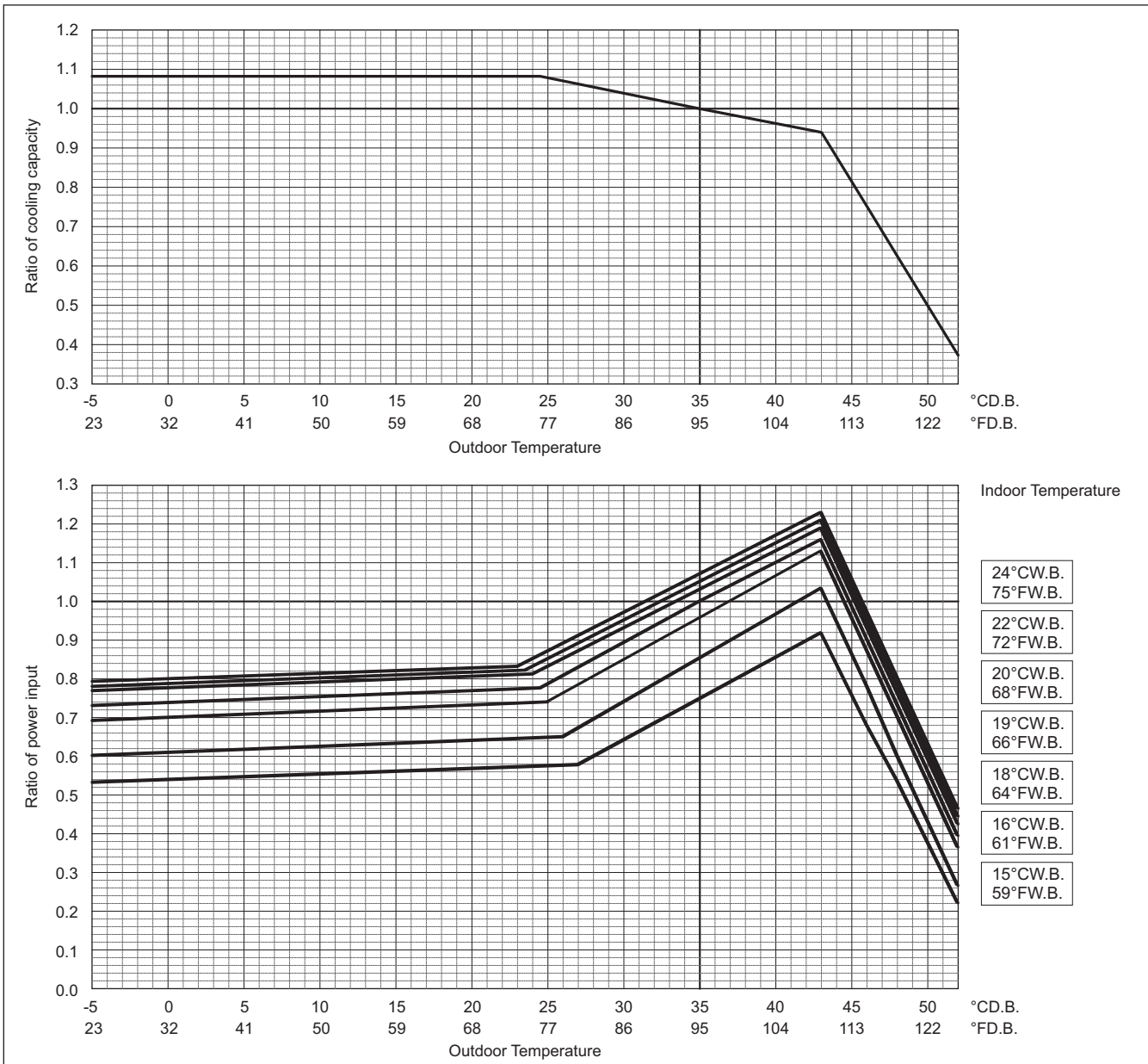

| | PUHY- | P400YSNW-A1 | P450YSNW-A1 | P500YSNW-A1 |
|------------------|-------|-------------|-------------|-------------|
| Heating Capacity | kW | 50.0 | 56.0 | 63.0 |
| | BTU/h | 170,600 | 191,100 | 215,000 |
| Input | kW | 10.52 | 12.55 | 14.89 |

Indoor unit temperature correction

To be used to correct indoor unit capacity only

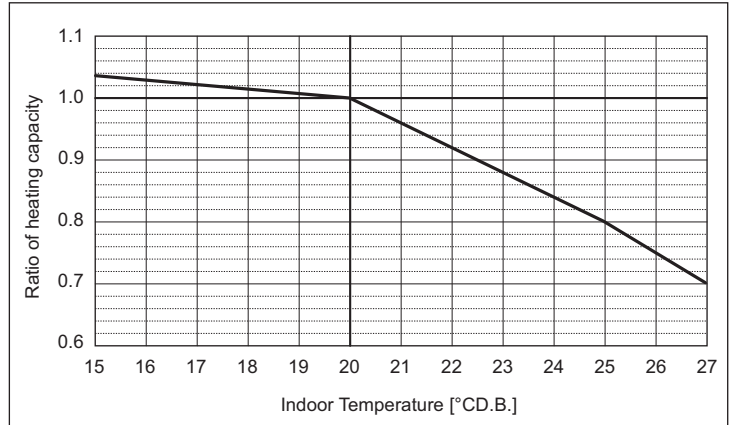

Outdoor unit temperature correction

To be used to correct outdoor unit only

Outdoor unit capacity is NOT affected by the indoor temperature.

Outdoor unit power input is affected by the indoor and outdoor temperatures. Please consult the sales office for details.

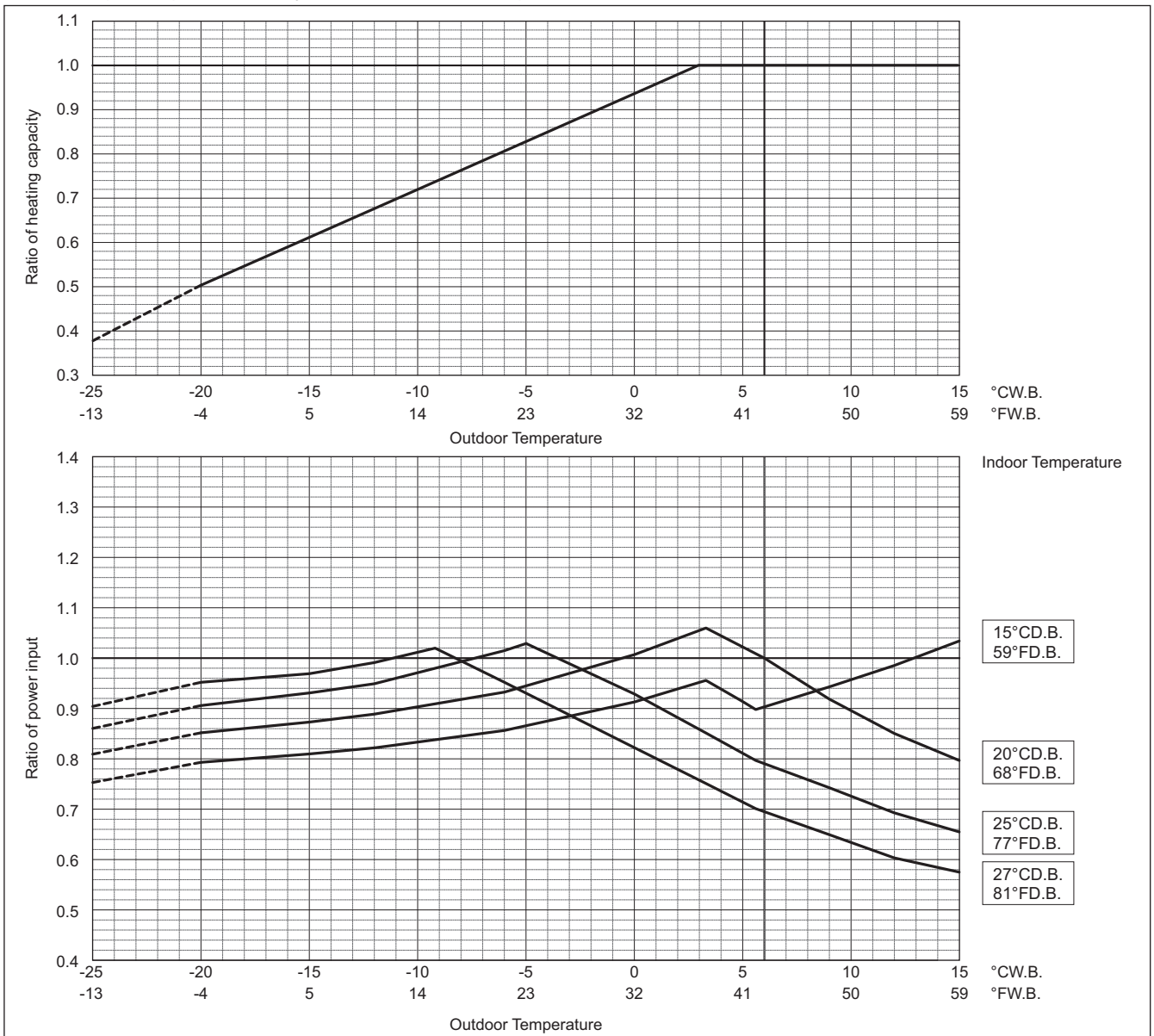

Values in the heating temperature correction diagram in the range below -20°C (-4°F) are reference values and not guaranteed values. Do not use these reference values for selecting outdoor unit models.

When applying product below -20°C (-4°F), consult your design engineer for cold climate application best practices, including the use of a backup source for heating.

PUHY-P-Y(S)NW-A1

PUHY-P-Y(S)NW-A1

| PUHY- | | P550YSNW-A1 | P600YSNW-A1 | P650YSNW-A1 |
|------------------|-------|-------------|-------------|-------------|
| Cooling Capacity | kW | 63.0 | 69.0 | 73.0 |
| | BTU/h | 215,000 | 235,400 | 249,100 |
| Input | kW | 16.84 | 18.69 | 21.79 |

| PUHY- | | P700YSNW-A1 | P750YSNW-A1 | P800YSNW-A1 |
|------------------|-------|-------------|-------------|-------------|
| Cooling Capacity | kW | 80.0 | 85.0 | 90.0 |
| | BTU/h | 273,000 | 290,000 | 307,100 |
| Input | kW | 22.59 | 25.83 | 26.31 |

Indoor unit temperature correction
To be used to correct indoor unit capacity only

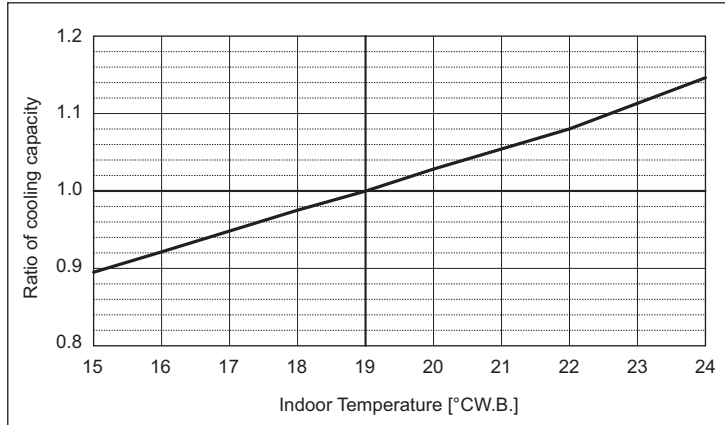

Outdoor unit temperature correction

To be used to correct outdoor unit only
Outdoor unit capacity is NOT affected by the indoor temperature.
Outdoor unit power input is affected by the indoor and outdoor temperatures. Please consult the sales office for details.

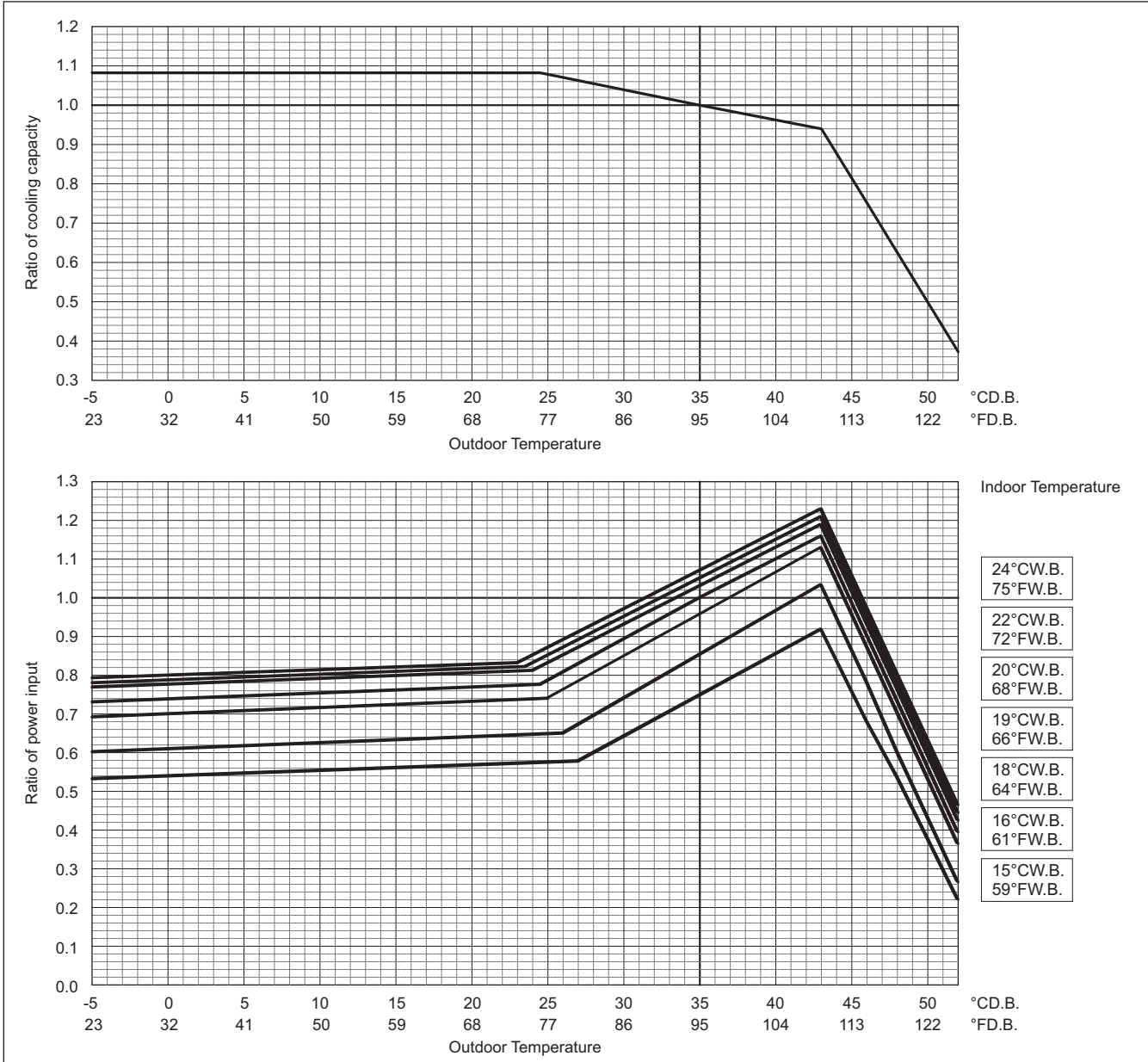

| PUHY- | | P550YSNW-A1 | P600YSNW-A1 | P650YSNW-A1 |
|------------------|-------|-------------|-------------|-------------|
| Heating Capacity | kW | 69.0 | 76.5 | 81.5 |
| | BTU/h | 235,400 | 216,000 | 278,100 |
| Input | kW | 16.15 | 17.83 | 20.17 |

| PUHY- | | P700YSNW-A1 | P750YSNW-A1 | P800YSNW-A1 |
|------------------|-------|-------------|-------------|-------------|
| Heating Capacity | kW | 88.0 | 95.0 | 100.0 |
| | BTU/h | 300,300 | 324,100 | 341,200 |
| Input | kW | 20.95 | 23.45 | 24.87 |

Indoor unit temperature correction

To be used to correct indoor unit capacity only

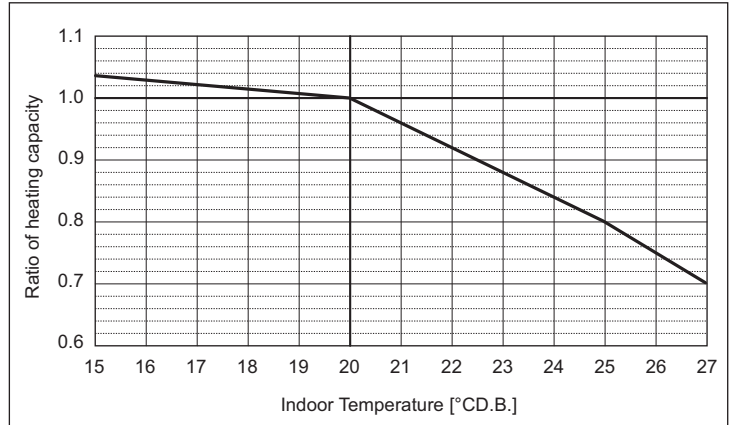

Outdoor unit temperature correction

To be used to correct outdoor unit only

Outdoor unit capacity is NOT affected by the indoor temperature.

Outdoor unit power input is affected by the indoor and outdoor temperatures. Please consult the sales office for details.

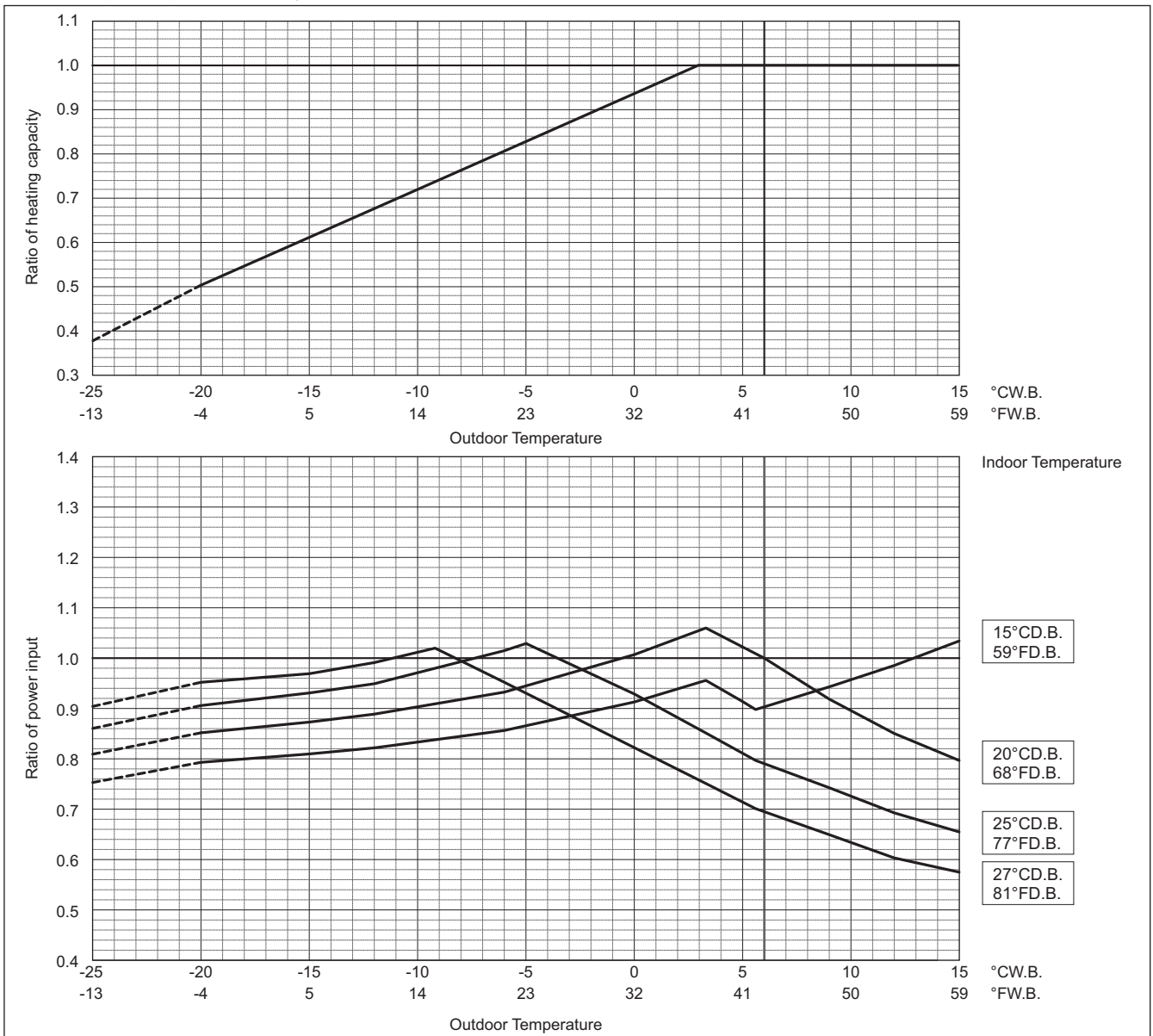

Values in the heating temperature correction diagram in the range below -20°C (-4°F) are reference values and not guaranteed values. Do not use these reference values for selecting outdoor unit models.

When applying product below -20°C (-4°F), consult your design engineer for cold climate application best practices, including the use of a backup source for heating.

PUHY-P-Y(S)NW-A1

| PUHY- | | P850YSNW-A1 | P900YSNW-A1 | P950YSNW-A1 |
|------------------|-------|-------------|-------------|-------------|
| Cooling Capacity | kW | 96.0 | 101.0 | 108.0 |
| | BTU/h | 327,600 | 344,600 | 368,500 |
| Input | kW | 30.00 | 30.42 | 30.00 |

| PUHY- | | P1000YSNW-A1 | P1050YSNW-A1 | P1100YSNW-A1 |
|------------------|-------|--------------|--------------|--------------|
| Cooling Capacity | kW | 113.0 | 118.0 | 124.0 |
| | BTU/h | 385,600 | 402,600 | 423,100 |
| Input | kW | 33.13 | 36.41 | 36.79 |

| PUHY- | | P1150YSNW-A1 | P1200YSNW-A1 | P1250YSNW-A1 |
|------------------|-------|--------------|--------------|--------------|
| Cooling Capacity | kW | 130.0 | 136.0 | 140.0 |
| | BTU/h | 443,600 | 464,000 | 477,700 |
| Input | kW | 40.49 | 44.29 | 44.30 |

| PUHY- | | P1300YSNW-A1 | P1350YSNW-A1 |
|------------------|-------|--------------|--------------|
| Cooling Capacity | kW | 146.0 | 150.0 |
| | BTU/h | 498,200 | 511,800 |
| Input | kW | 45.06 | 45.18 |

Indoor unit temperature correction
To be used to correct indoor unit capacity only

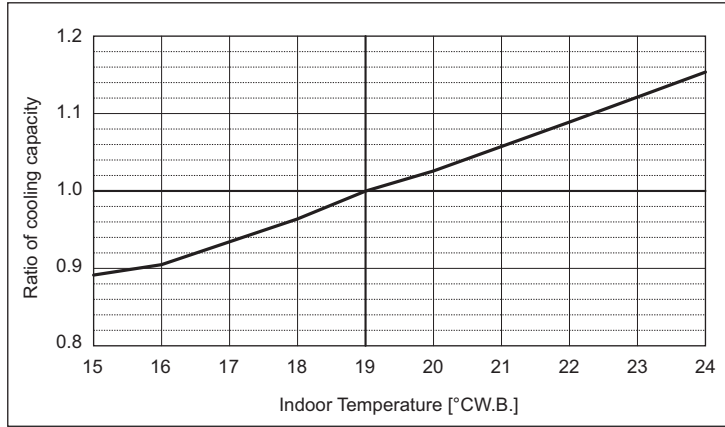

Outdoor unit temperature correction

To be used to correct outdoor unit only
Outdoor unit capacity is NOT affected by the indoor temperature.
Outdoor unit power input is affected by the indoor and outdoor temperatures. Please consult the sales office for details.

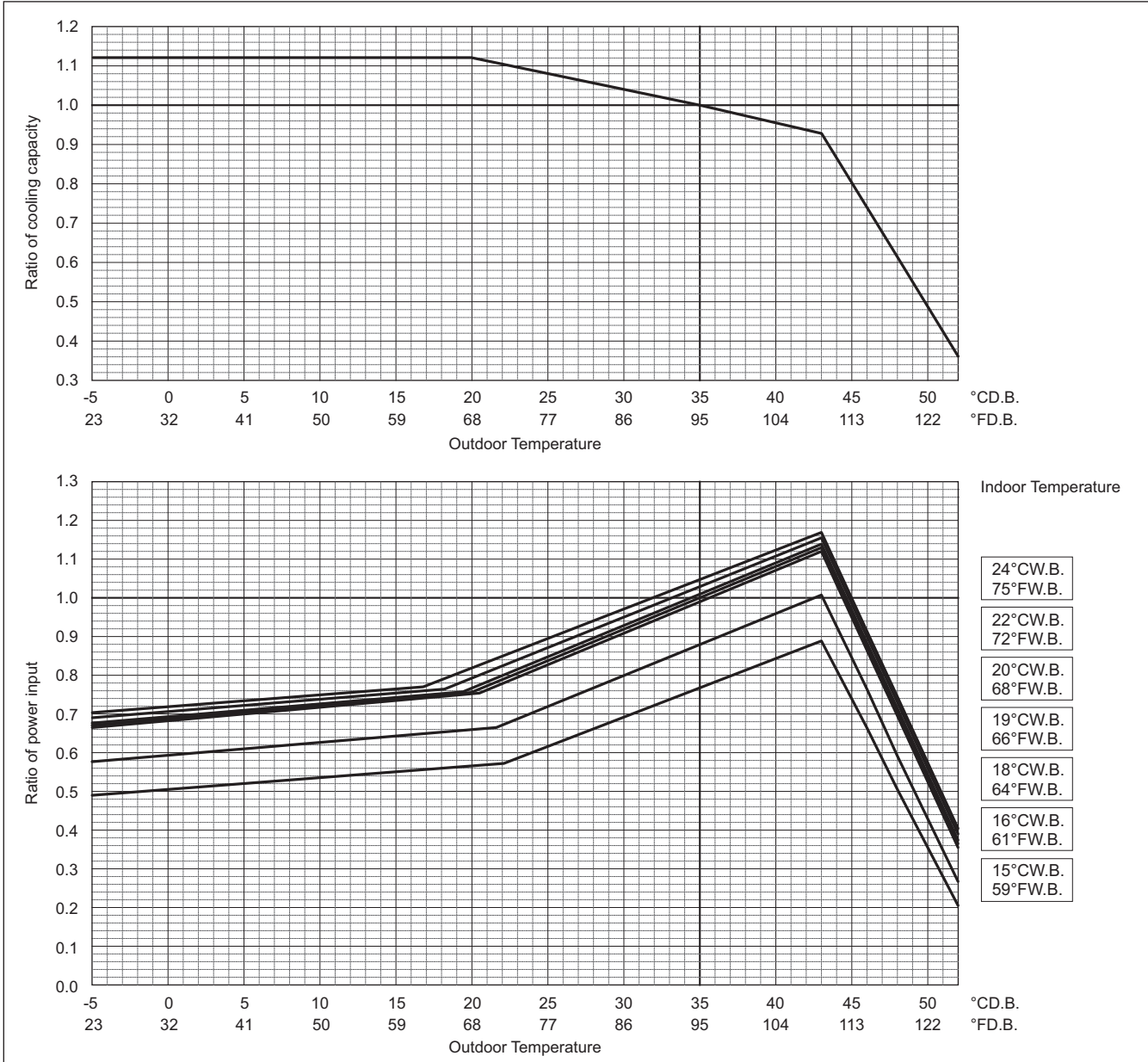

| PUHY- | | P850YSNW-A1 | P900YSNW-A1 | P950YSNW-A1 |
|------------------|-------|-------------|-------------|-------------|
| Heating Capacity | kW | 108.0 | 113.0 | 119.5 |
| | BTU/h | 368,500 | 385,600 | 407,700 |
| Input | kW | 27.76 | 29.12 | 28.38 |

| PUHY- | | P1000YSNW-A1 | P1050YSNW-A1 | P1100YSNW-A1 |
|------------------|-------|--------------|--------------|--------------|
| Heating Capacity | kW | 127.0 | 132.0 | 140.0 |
| | BTU/h | 433,300 | 450,400 | 477,700 |
| Input | kW | 31.05 | 33.08 | 34.22 |

| PUHY- | | P1150YSNW-A1 | P1200YSNW-A1 | P1250YSNW-A1 |
|------------------|-------|--------------|--------------|--------------|
| Heating Capacity | kW | 145.0 | 150.0 | 156.5 |
| | BTU/h | 494,700 | 511,800 | 534,000 |
| Input | kW | 36.25 | 38.36 | 40.12 |

| PUHY- | | P1300YSNW-A1 | P1350YSNW-A1 |
|------------------|-------|--------------|--------------|
| Heating Capacity | kW | 163.0 | 168.0 |
| | BTU/h | 556,200 | 573,200 |
| Input | kW | 41.90 | 43.29 |

Indoor unit temperature correction
To be used to correct indoor unit capacity only

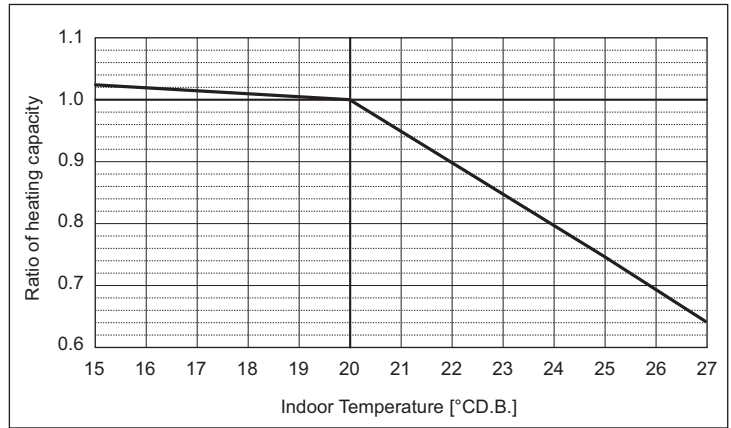

Outdoor unit temperature correction

To be used to correct outdoor unit only
Outdoor unit capacity is NOT affected by the indoor temperature.
Outdoor unit power input is affected by the indoor and outdoor temperatures. Please consult the sales office for details.

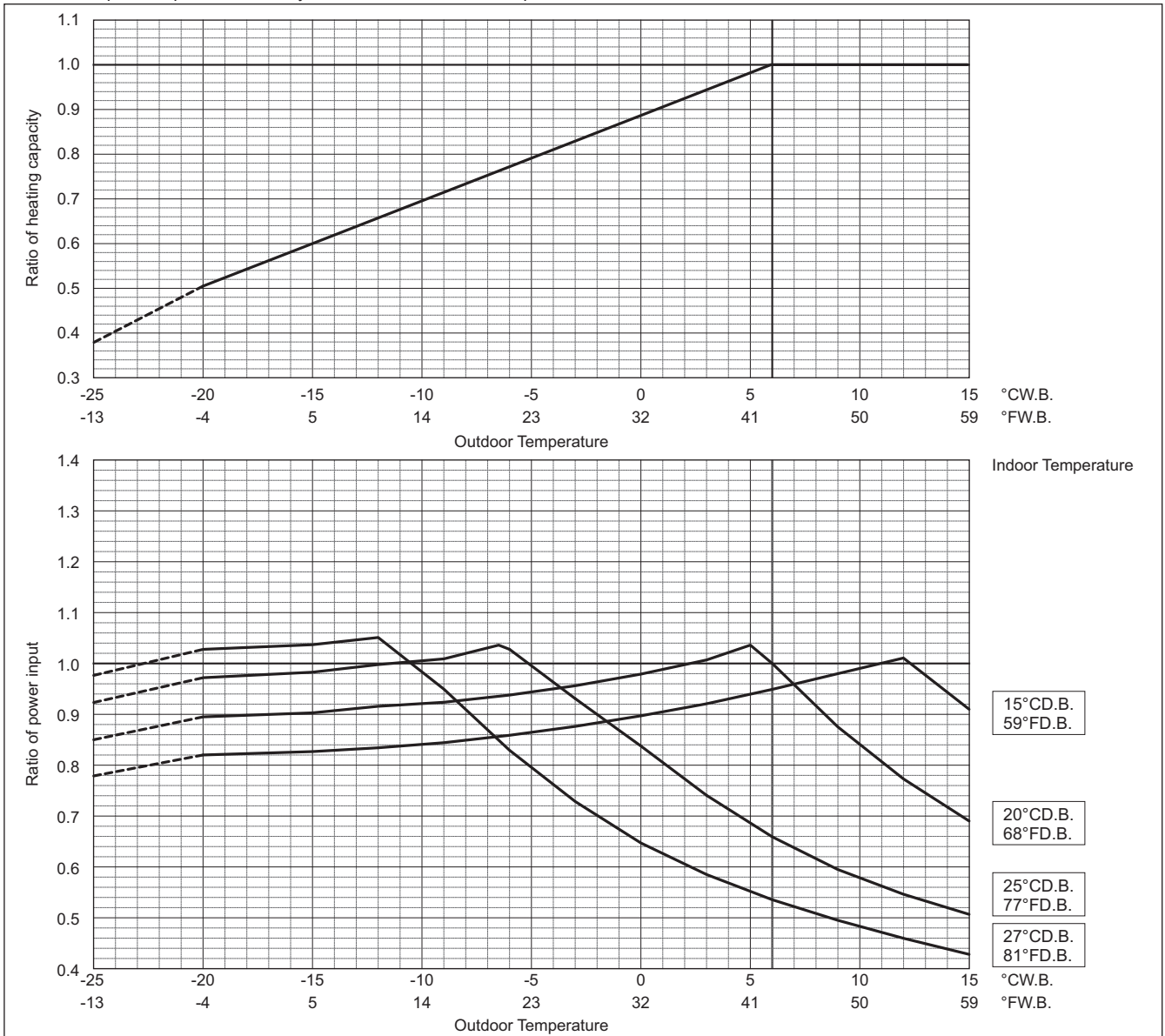

Values in the heating temperature correction diagram in the range below -20°C (-4°F) are reference values and not guaranteed values. Do not use these reference values for selecting outdoor unit models.

When applying product below -20°C (-4°F), consult your design engineer for cold climate application best practices, including the use of a backup source for heating.

Correction by temperature (Capacity Priority Mode only for heating)

CITY MULTI could have various capacities at different designing temperatures. Using the nominal cooling/heating capacity values and the ratios below, the capacity can be found for various temperatures. To select capacity priority mode, DipSW 6-2 must be set to ON.

| PUHY- | P200YNW-A1 | P250YNW-A1 |
|------------------|------------|------------|
| Cooling Capacity | 22.4 | 28.0 |
| Input | 4.81 | 7.14 |

Indoor unit temperature correction

To be used to correct indoor unit capacity only

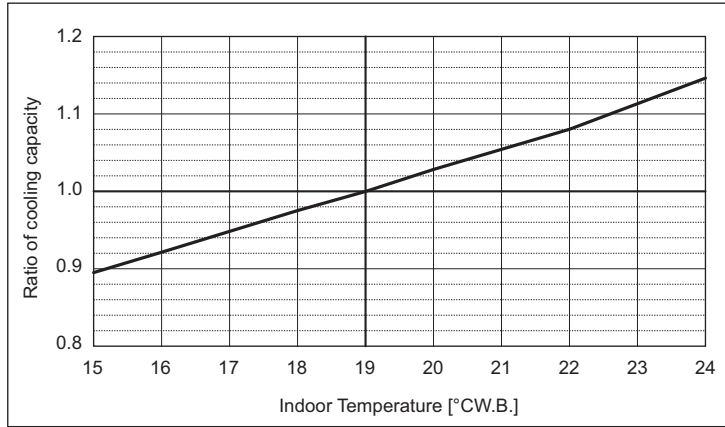

Outdoor unit temperature correction

To be used to correct outdoor unit only

Outdoor unit capacity is NOT affected by the indoor temperature.

Outdoor unit power input is affected by the indoor and outdoor temperatures. Please consult the sales office for details.

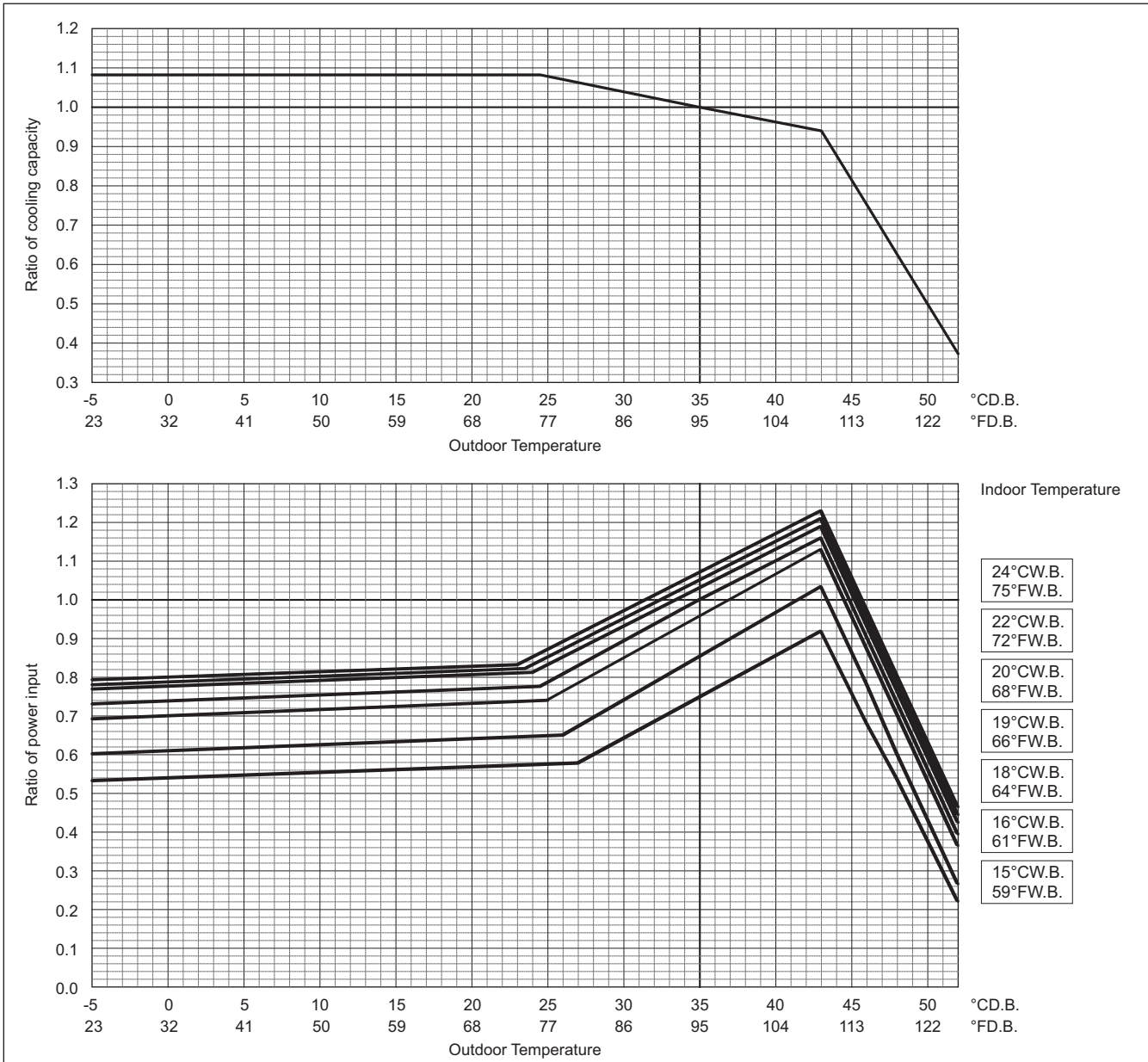

PUHY-P-Y(S)NW-A1

Capacity Priority Mode

| | PUHY- | P200YNW-A1 | P250YNW-A1 |
|------------------|-------|------------|------------|
| Heating Capacity | kW | 25.0 | 31.5 |
| | BTU/h | 85,300 | 107,500 |
| Input | kW | 5.10 | 7.20 |

Indoor unit temperature correction

To be used to correct indoor unit capacity only

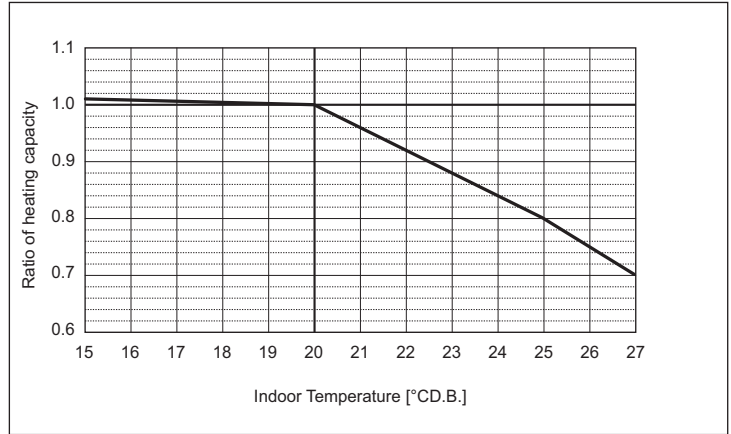

Outdoor unit temperature correction

To be used to correct outdoor unit only

Outdoor unit capacity is NOT affected by the indoor temperature.

Outdoor unit power input is affected by the indoor and outdoor temperatures. Please consult the sales office for details.

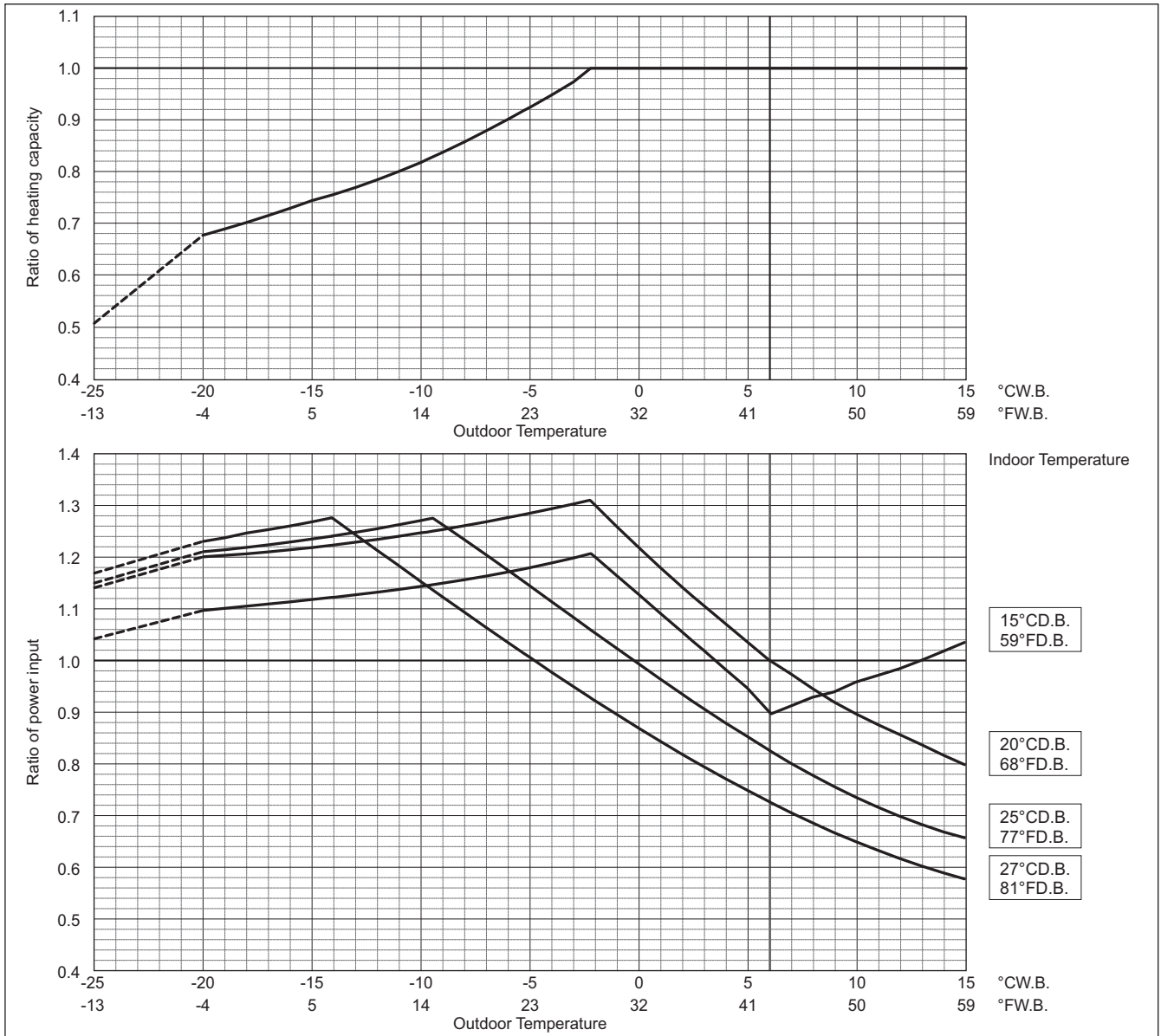

Values in the heating temperature correction diagram in the range below -20°C (-4°F) are reference values and not guaranteed values. Do not use these reference values for selecting outdoor unit models.

When applying product below -20°C (-4°F), consult your design engineer for cold climate application best practices, including the use of a backup source for heating.

| PUHY- | | P300YNW-A1 | P350YNW-A1 |
|------------------|-------|------------|------------|
| Cooling Capacity | kW | 33.5 | 40.0 |
| | BTU/h | 114,300 | 136,500 |
| Input | kW | 8.79 | 10.95 |

Indoor unit temperature correction
To be used to correct indoor unit capacity only

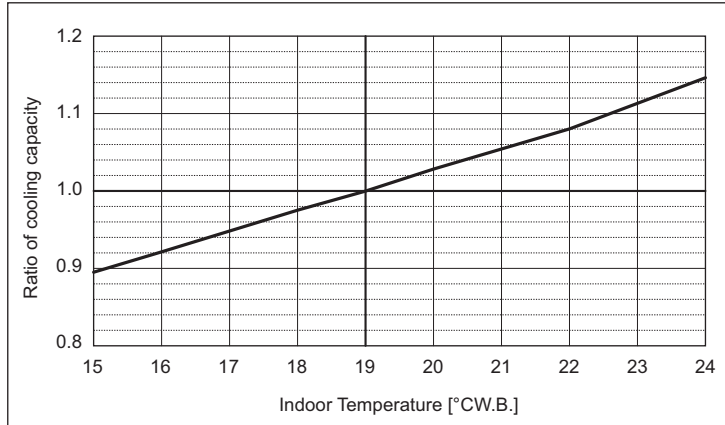

Outdoor unit temperature correction

To be used to correct outdoor unit only

Outdoor unit capacity is NOT affected by the indoor temperature.

Outdoor unit power input is affected by the indoor and outdoor temperatures. Please consult the sales office for details.

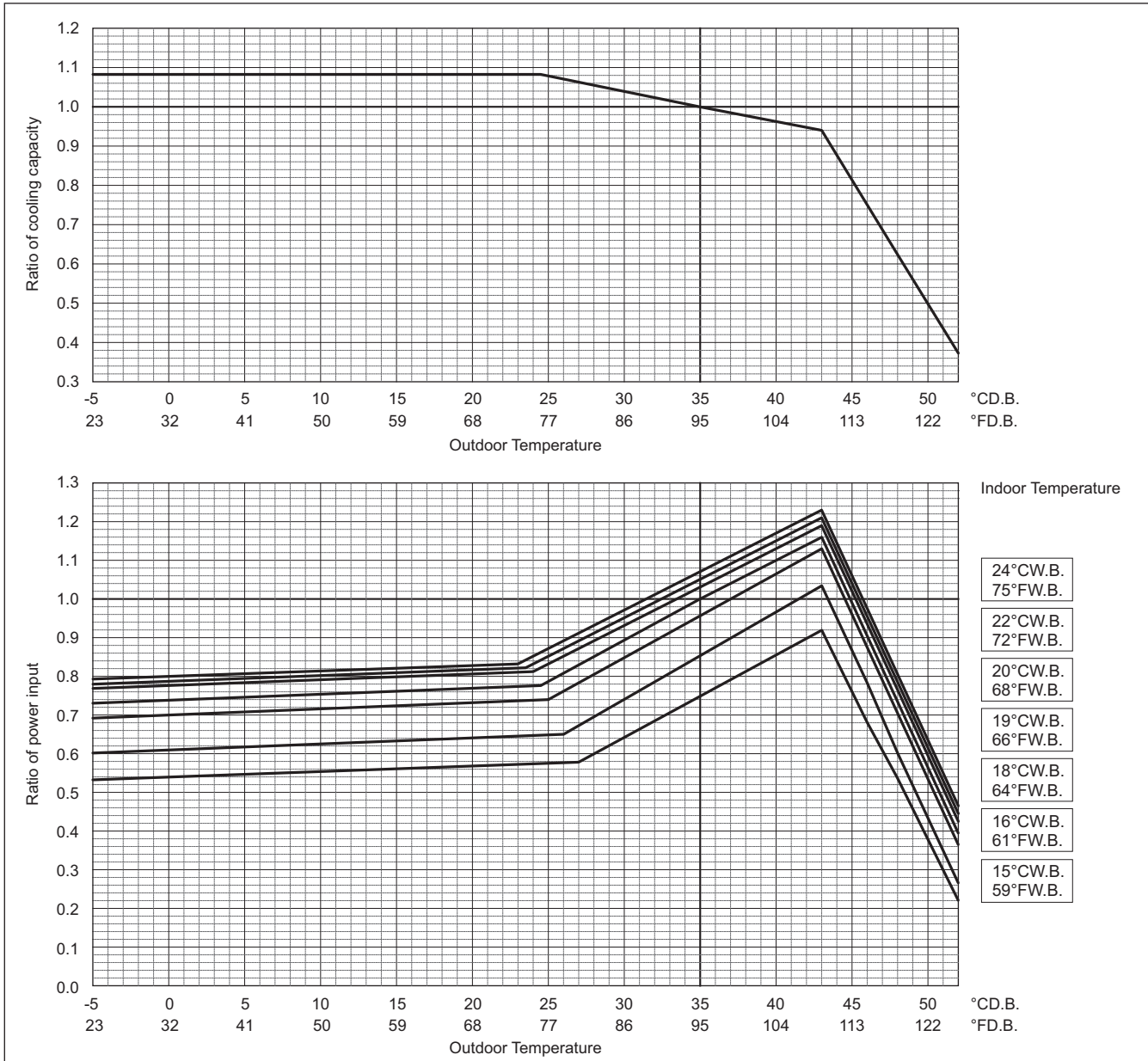

PUHY-P-Y(S)NW-A1

Capacity Priority Mode

| | PUHY- | P300YNW-A1 | P350YNW-A1 |
|------------------|-------|------------|------------|
| Heating Capacity | kW | 37.5 | 45.0 |
| | BTU/h | 128,000 | 153,500 |
| Input | kW | 8.46 | 10.39 |

Indoor unit temperature correction

To be used to correct indoor unit capacity only

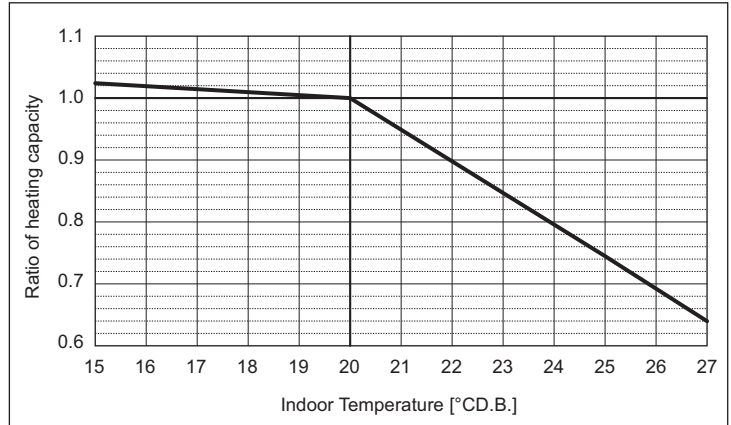

Outdoor unit temperature correction

To be used to correct outdoor unit only

Outdoor unit capacity is NOT affected by the indoor temperature.

Outdoor unit power input is affected by the indoor and outdoor temperatures. Please consult the sales office for details.

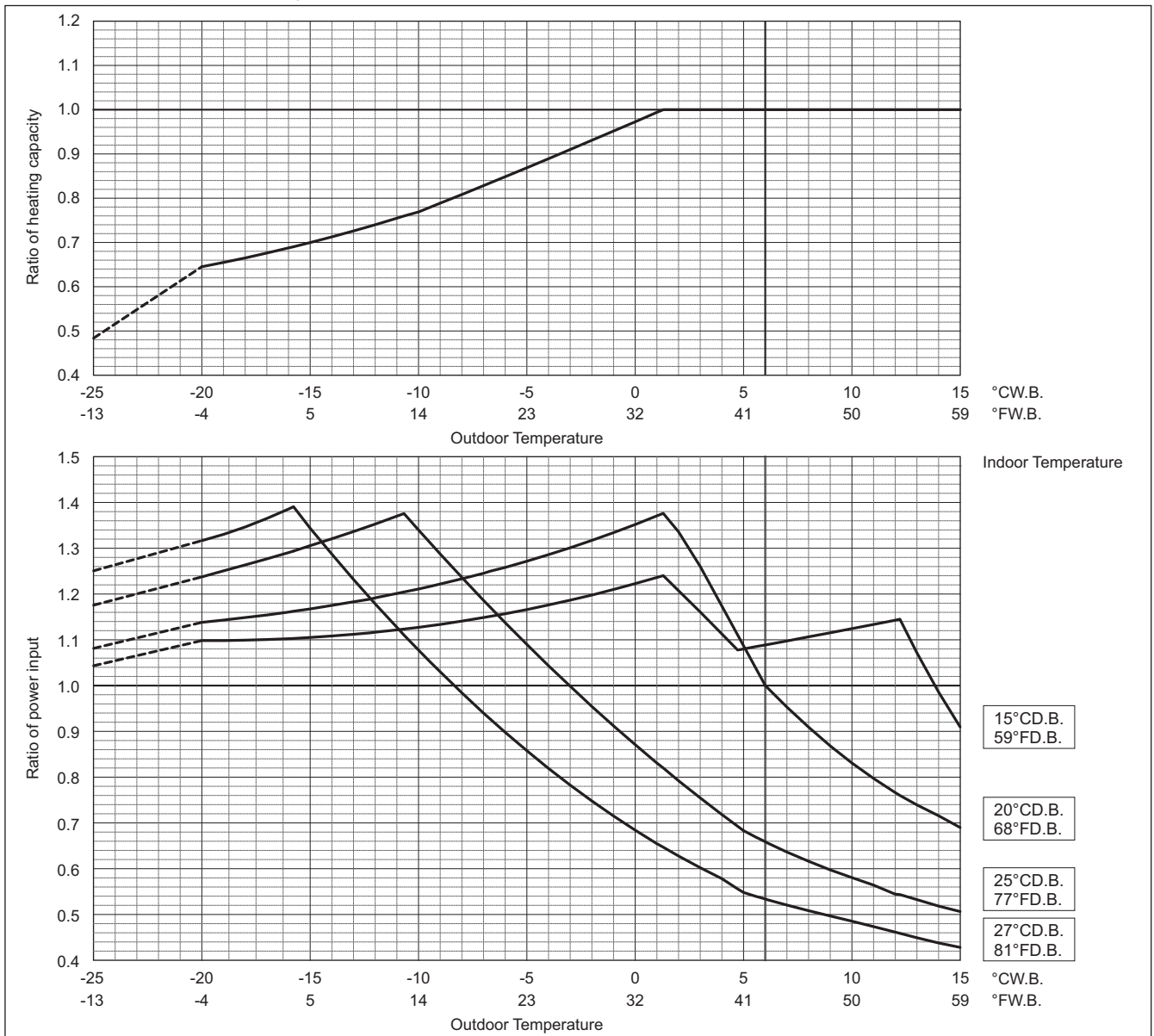

Values in the heating temperature correction diagram in the range below -20°C (-4°F) are reference values and not guaranteed values. Do not use these reference values for selecting outdoor unit models.

When applying product below -20°C (-4°F), consult your design engineer for cold climate application best practices, including the use of a backup source for heating.

PUHY-P-Y(S)NW-A1

| PUHY- | | P400YNW-A1 | P450YNW-A1 | P500YNW-A1 |
|------------------|-------|------------|------------|------------|
| Cooling Capacity | kW | 45.0 | 50.0 | 56.0 |
| | BTU/h | 153,500 | 170,600 | 191,100 |
| Input | kW | 14.19 | 14.57 | 17.55 |

Indoor unit temperature correction
To be used to correct indoor unit capacity only

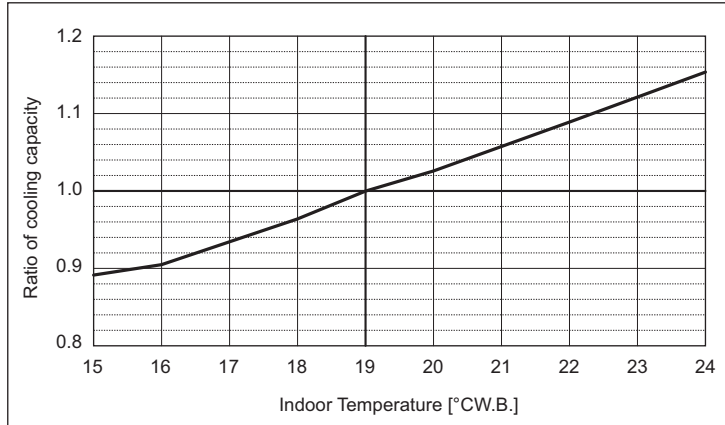

Outdoor unit temperature correction

To be used to correct outdoor unit only

Outdoor unit capacity is NOT affected by the indoor temperature.

Outdoor unit power input is affected by the indoor and outdoor temperatures. Please consult the sales office for details.

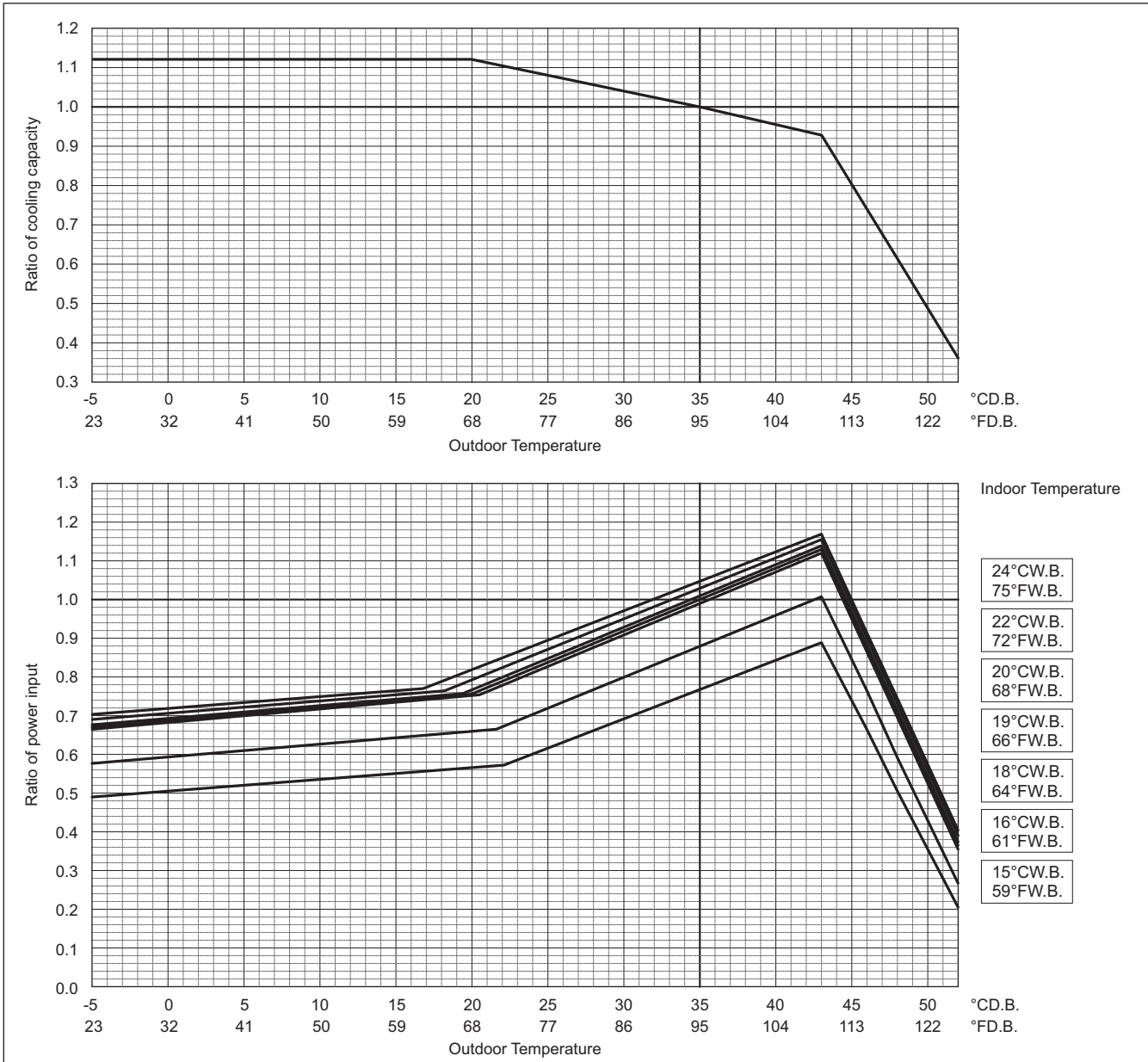

Capacity Priority Mode

| | PUHY- | P400YNW-A1 | P450YNW-A1 | P500YNW-A1 |
|------------------|-------|------------|------------|------------|
| Heating Capacity | kW | 50.0 | 56.0 | 63.0 |
| | BTU/h | 170,600 | 191,100 | 215,000 |
| Input | kW | 12.37 | 14.00 | 15.98 |

Indoor unit temperature correction

To be used to correct indoor unit capacity only

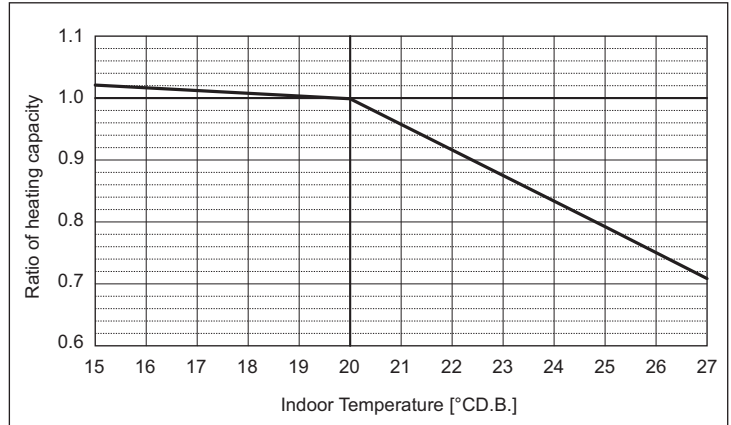

Outdoor unit temperature correction

To be used to correct outdoor unit only

Outdoor unit capacity is NOT affected by the indoor temperature.

Outdoor unit power input is affected by the indoor and outdoor temperatures. Please consult the sales office for details.

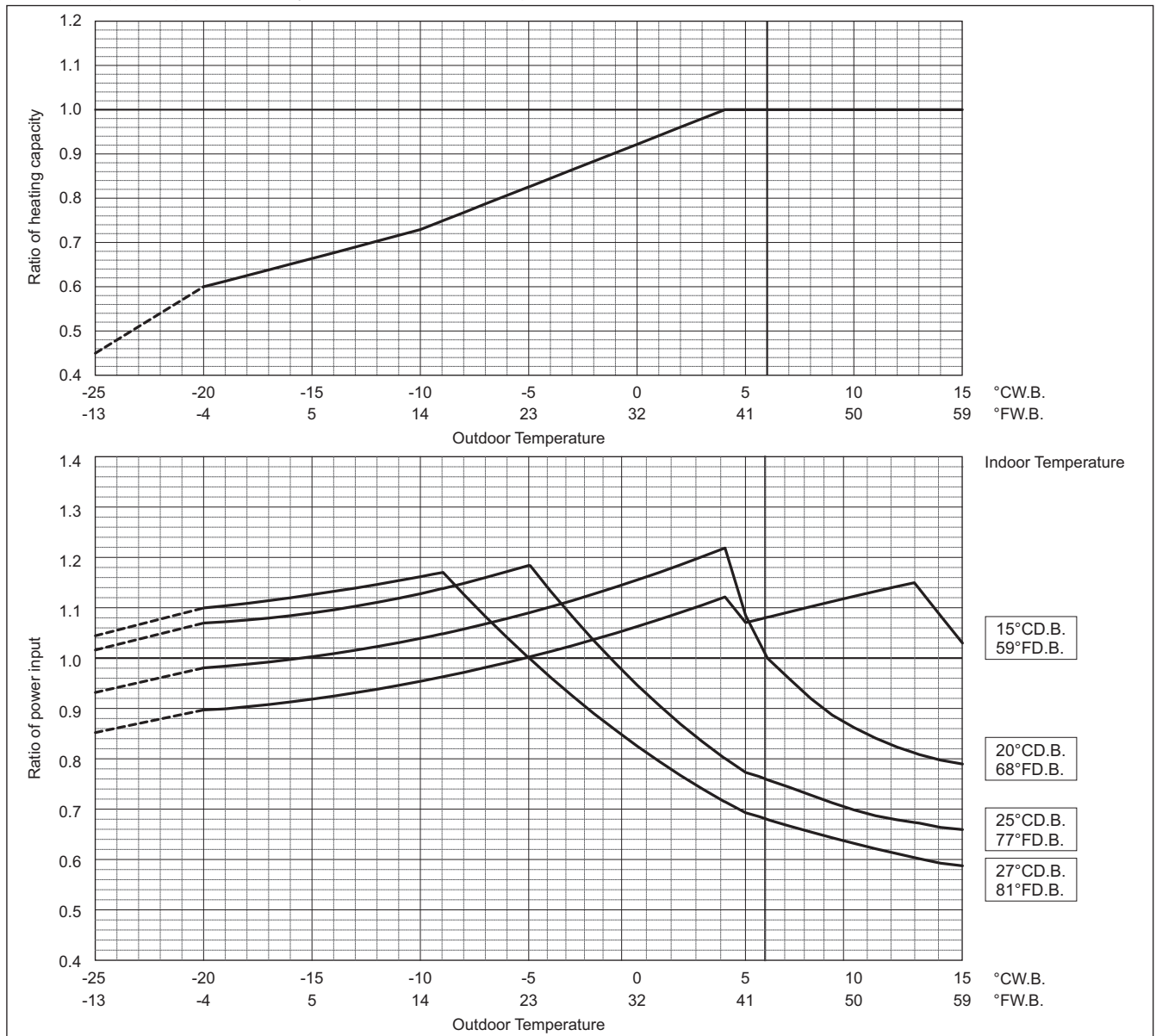

Values in the heating temperature correction diagram in the range below -20°C (-4°F) are reference values and not guaranteed values. Do not use these reference values for selecting outdoor unit models.

When applying product below -20°C (-4°F), consult your design engineer for cold climate application best practices, including the use of a backup source for heating.

PUHY-P-Y(S)NW-A1

| PUHY- | | P400YSNW-A1 | P450YSNW-A1 | P500YSNW-A1 |
|------------------|-------|-------------|-------------|-------------|
| Cooling Capacity | kW | 45.0 | 50.0 | 56.0 |
| | BTU/h | 153,500 | 170,600 | 191,100 |
| Input | kW | 9.97 | 12.16 | 14.73 |

Indoor unit temperature correction
To be used to correct indoor unit capacity only

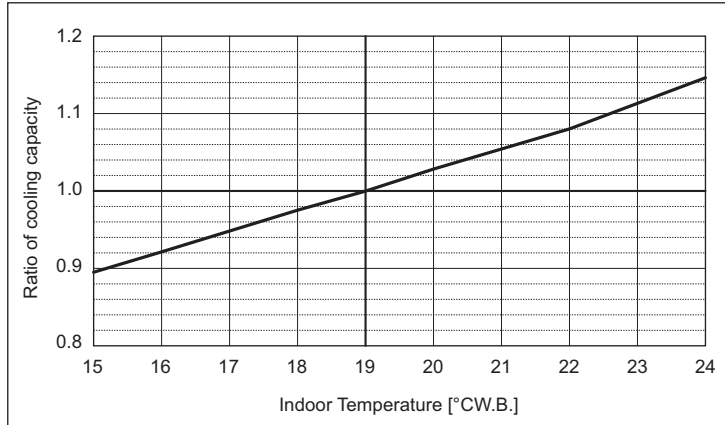

Outdoor unit temperature correction

To be used to correct outdoor unit only

Outdoor unit capacity is NOT affected by the indoor temperature.

Outdoor unit power input is affected by the indoor and outdoor temperatures. Please consult the sales office for details.

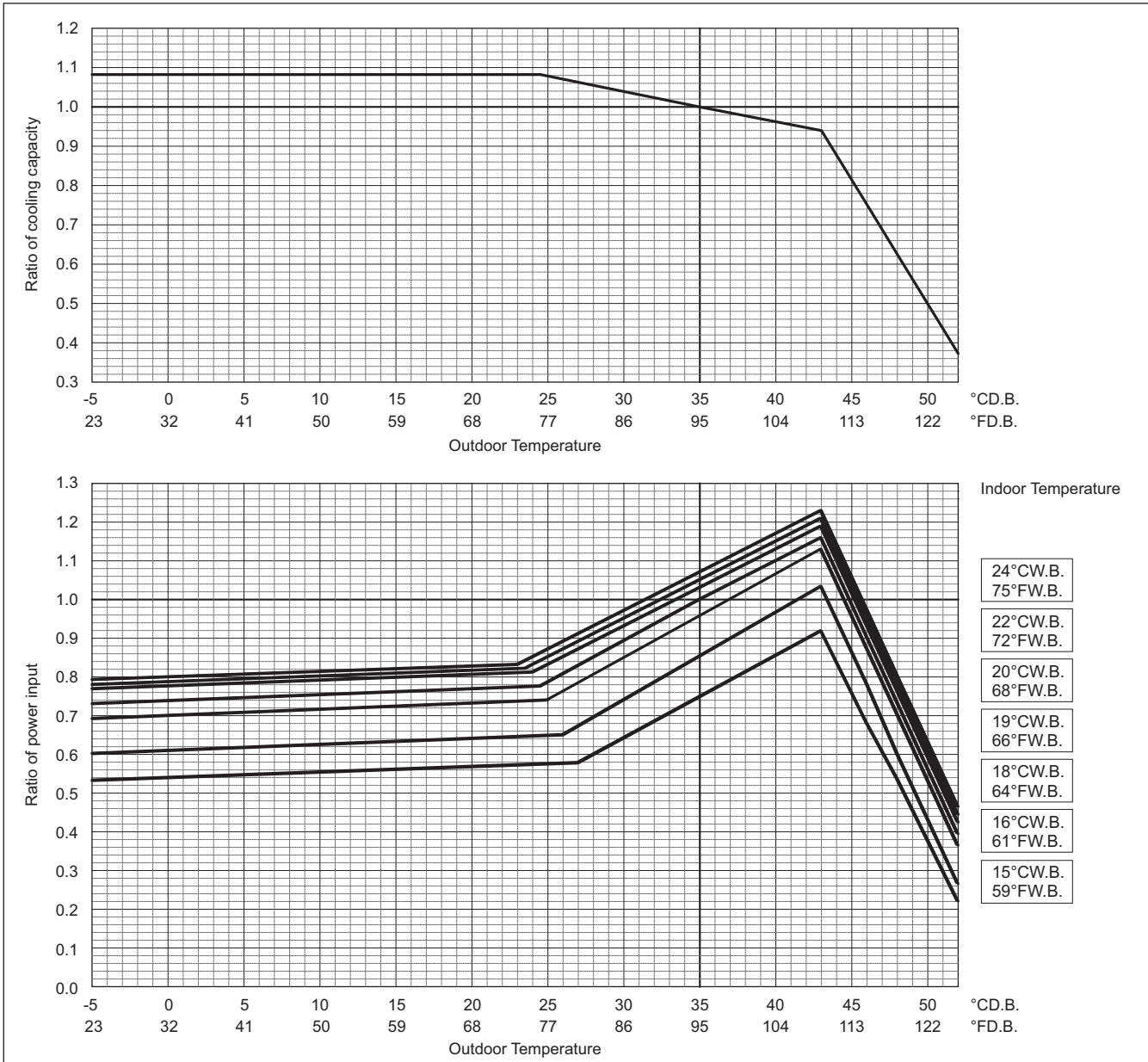

Capacity Priority Mode

| | PUHY- | P400YSNW-A1 | P450YSNW-A1 | P500YSNW-A1 |
|------------------|-------|-------------|-------------|-------------|
| Heating Capacity | kW | 50.0 | 56.0 | 63.0 |
| | BTU/h | 170,600 | 191,100 | 215,000 |
| Input | kW | 10.52 | 12.55 | 14.89 |

Indoor unit temperature correction

To be used to correct indoor unit capacity only

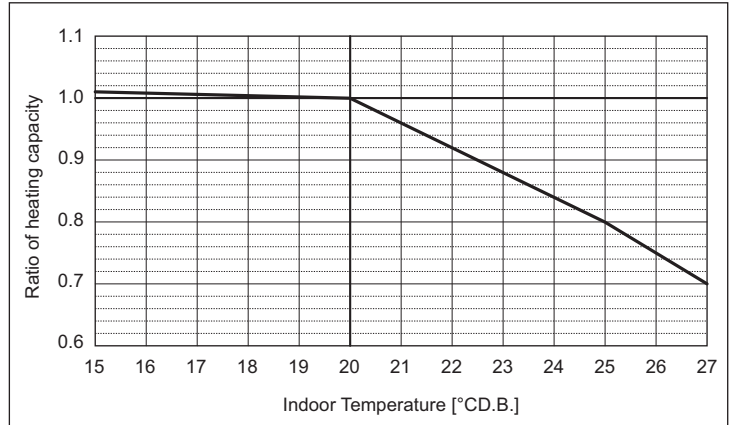

Outdoor unit temperature correction

To be used to correct outdoor unit only

Outdoor unit capacity is NOT affected by the indoor temperature.

Outdoor unit power input is affected by the indoor and outdoor temperatures. Please consult the sales office for details.

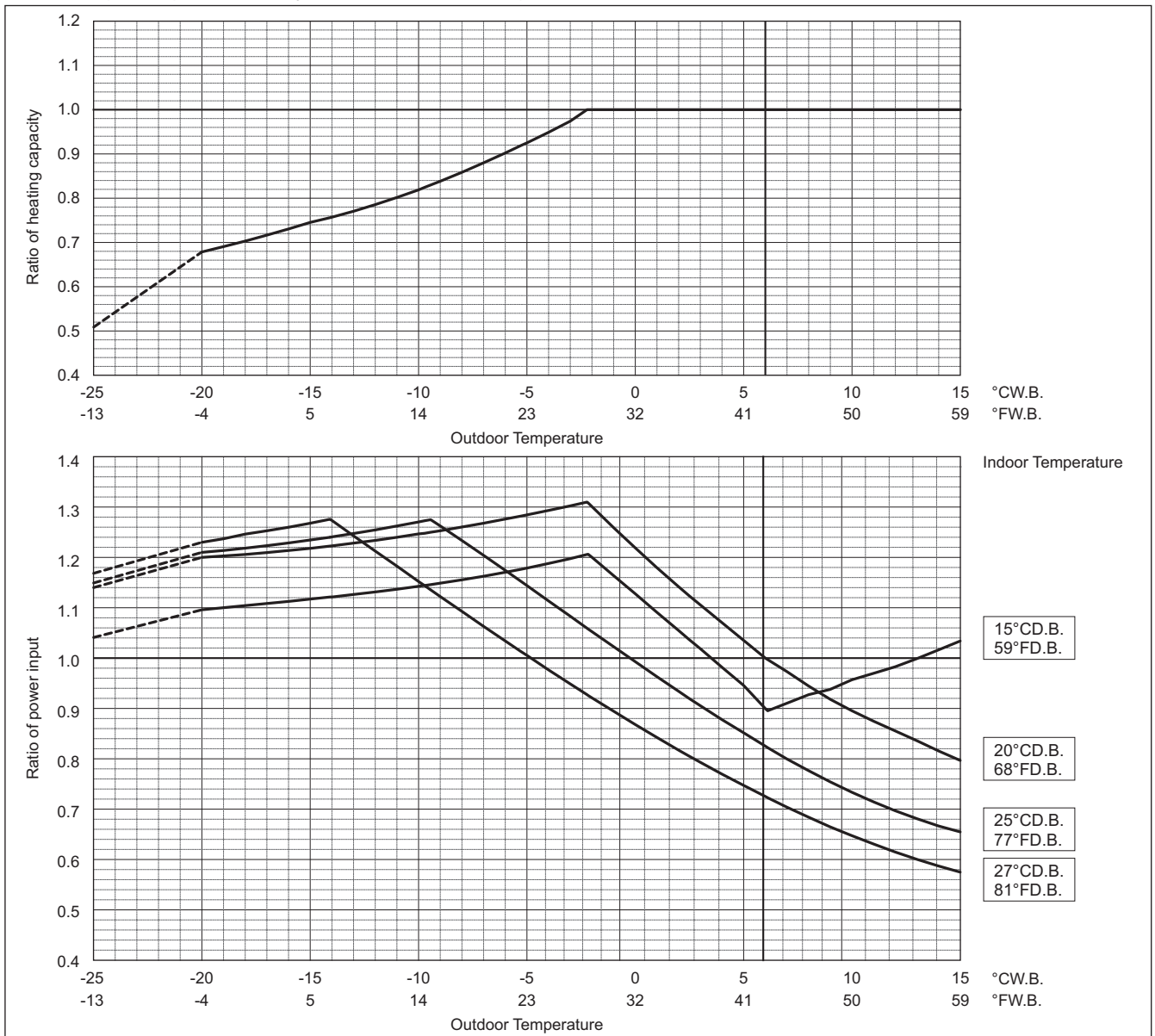

Values in the heating temperature correction diagram in the range below -20°C (-4°F) are reference values and not guaranteed values. Do not use these reference values for selecting outdoor unit models.

When applying product below -20°C (-4°F), consult your design engineer for cold climate application best practices, including the use of a backup source for heating.

PUHY-P-Y(S)NW-A1

| PUHY- | | P550YSNW-A1 | P600YSNW-A1 | P650YSNW-A1 |
|------------------|-------|-------------|-------------|-------------|
| Cooling Capacity | kW | 63.0 | 69.0 | 73.0 |
| | BTU/h | 215,000 | 235,400 | 249,100 |
| Input | kW | 16.84 | 18.69 | 21.79 |

| PUHY- | | P700YSNW-A1 | P750YSNW-A1 | P800YSNW-A1 |
|------------------|-------|-------------|-------------|-------------|
| Cooling Capacity | kW | 80.0 | 85.0 | 90.0 |
| | BTU/h | 273,000 | 290,000 | 307,100 |
| Input | kW | 22.59 | 25.83 | 26.31 |

Indoor unit temperature correction
To be used to correct indoor unit capacity only

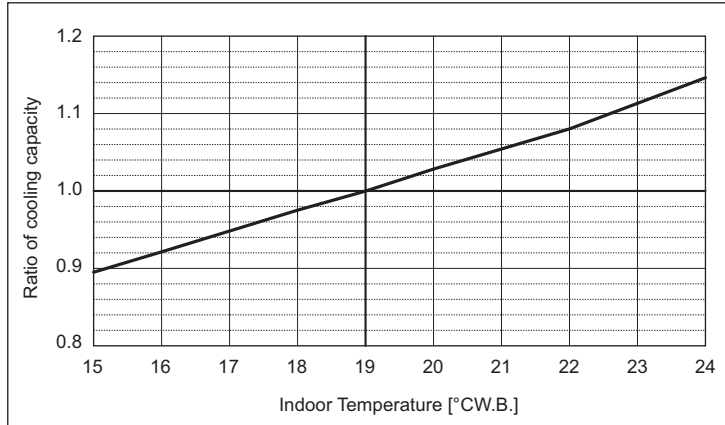

Outdoor unit temperature correction

To be used to correct outdoor unit only

Outdoor unit capacity is NOT affected by the indoor temperature.

Outdoor unit power input is affected by the indoor and outdoor temperatures. Please consult the sales office for details.

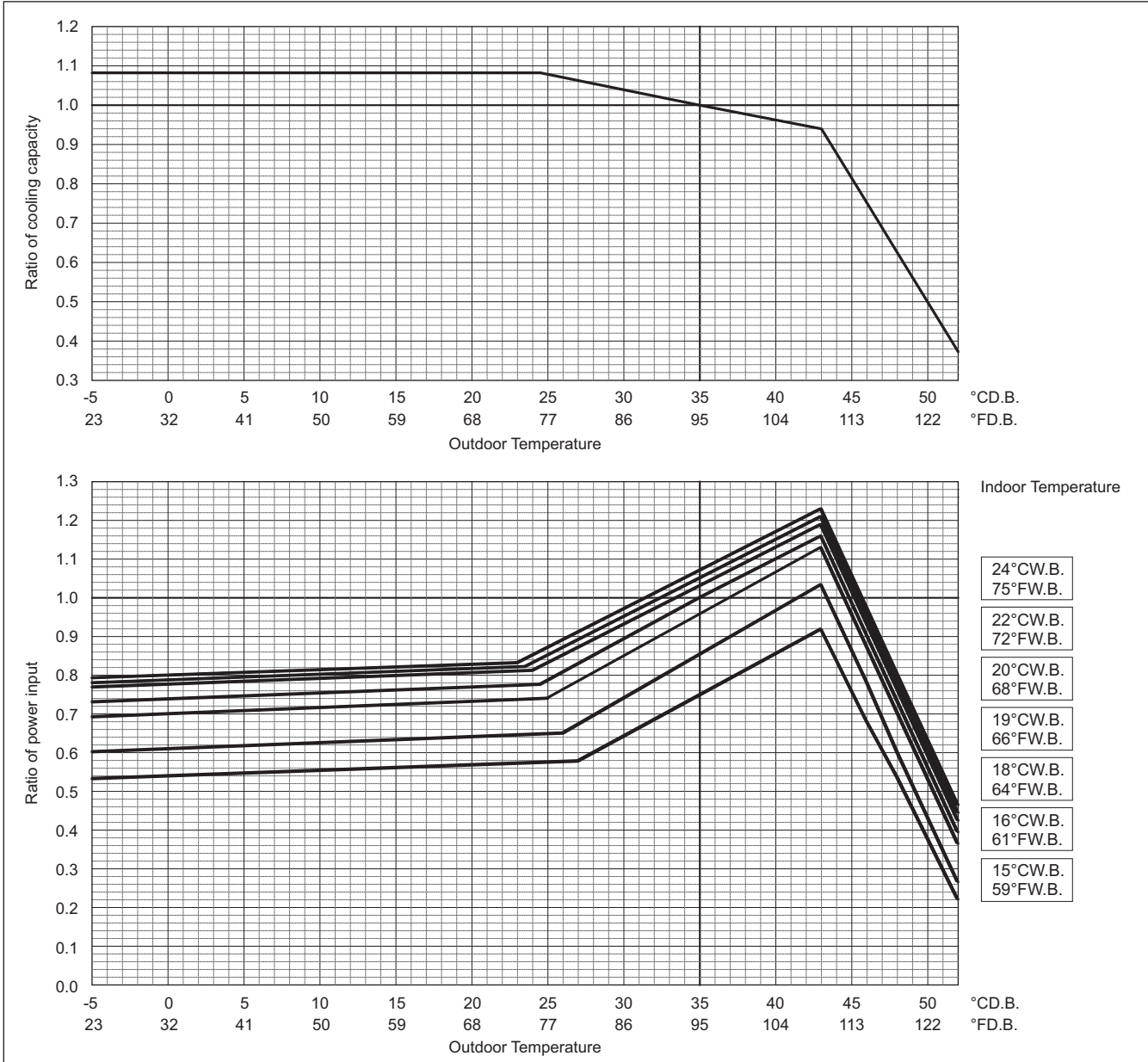

Capacity Priority Mode

| PUHY- | | P550YSNW-A1 | P600YSNW-A1 | P650YSNW-A1 |
|------------------|-------|-------------|-------------|-------------|
| Heating Capacity | kW | 69.0 | 76.5 | 81.5 |
| | BTU/h | 235,400 | 216,000 | 278,100 |
| Input | kW | 16.15 | 17.83 | 20.17 |

| PUHY- | | P700YSNW-A1 | P750YSNW-A1 | P800YSNW-A1 |
|------------------|-------|-------------|-------------|-------------|
| Heating Capacity | kW | 88.0 | 95.0 | 100.0 |
| | BTU/h | 300,300 | 324,100 | 341,200 |
| Input | kW | 20.95 | 23.45 | 24.87 |

Indoor unit temperature correction

To be used to correct indoor unit capacity only

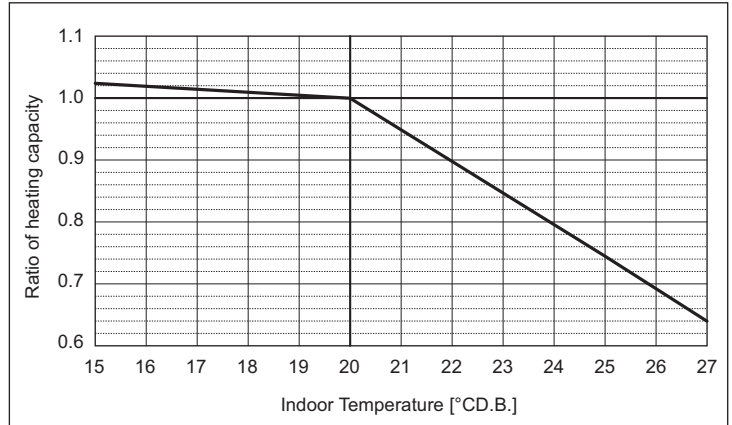

Outdoor unit temperature correction

To be used to correct outdoor unit only

Outdoor unit capacity is NOT affected by the indoor temperature.

Outdoor unit power input is affected by the indoor and outdoor temperatures. Please consult the sales office for details.

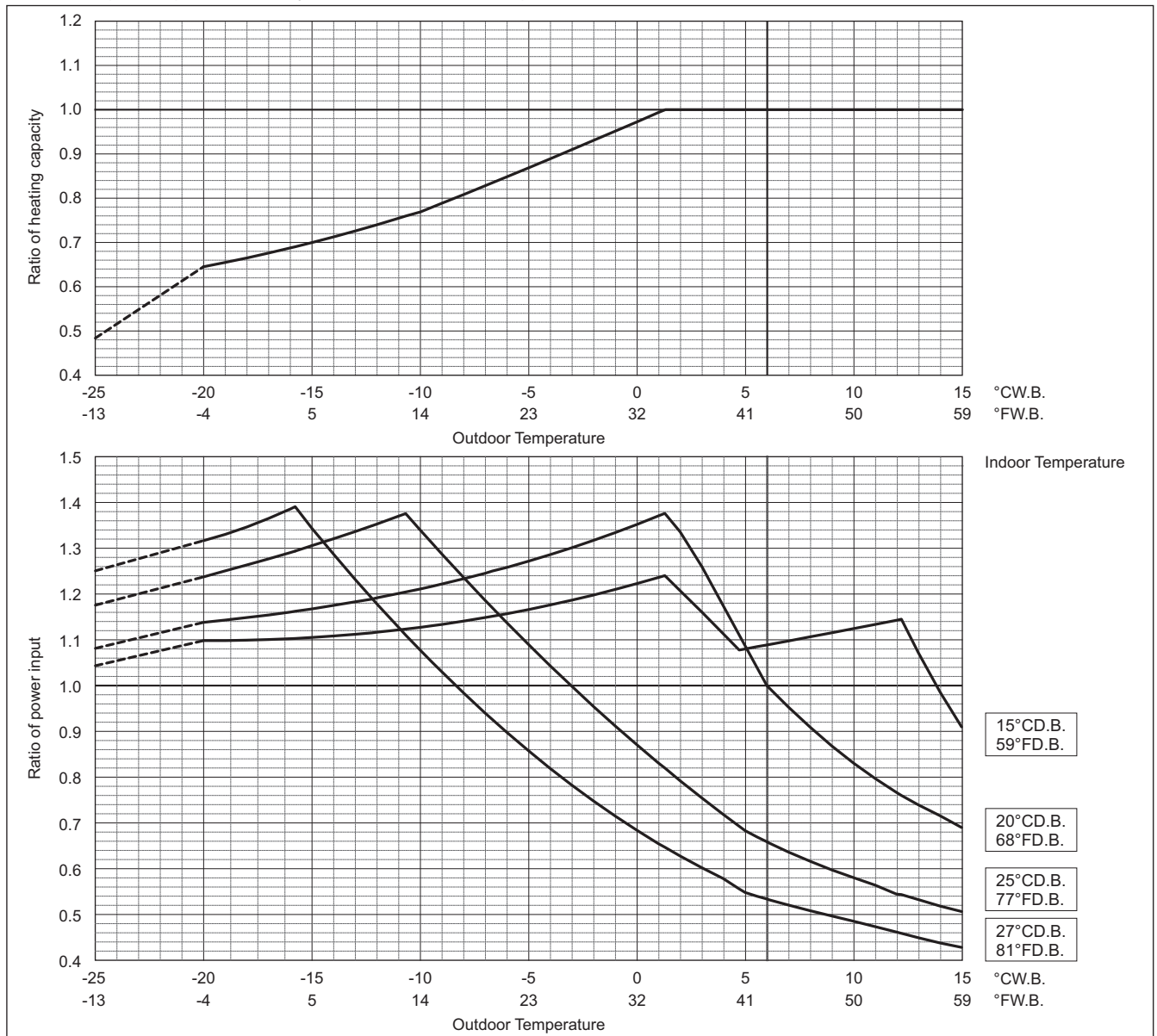

Values in the heating temperature correction diagram in the range below -20°C (-4°F) are reference values and not guaranteed values. Do not use these reference values for selecting outdoor unit models.

When applying product below -20°C (-4°F), consult your design engineer for cold climate application best practices, including the use of a backup source for heating.

PUHY-P-Y(S)NW-A1

| PUHY- | | P850YSNW-A1 | P900YSNW-A1 | P950YSNW-A1 |
|------------------|-------|--------------|--------------|--------------|
| Cooling Capacity | kW | 96.0 | 101.0 | 108.0 |
| | BTU/h | 327,600 | 344,600 | 368,500 |
| Input | kW | 30.00 | 30.42 | 30.00 |
| PUHY- | | P1000YSNW-A1 | P1050YSNW-A1 | P1100YSNW-A1 |
| Cooling Capacity | kW | 113.0 | 118.0 | 124.0 |
| | BTU/h | 385,600 | 402,600 | 423,100 |
| Input | kW | 33.13 | 36.41 | 36.79 |
| PUHY- | | P1150YSNW-A1 | P1200YSNW-A1 | P1250YSNW-A1 |
| Cooling Capacity | kW | 130.0 | 136.0 | 140.0 |
| | BTU/h | 443,600 | 464,000 | 477,700 |
| Input | kW | 40.49 | 44.29 | 44.30 |
| PUHY- | | P1300YSNW-A1 | P1350YSNW-A1 | |
| Cooling Capacity | kW | 146.0 | 150.0 | |
| | BTU/h | 498,200 | 511,800 | |
| Input | kW | 45.06 | 45.18 | |

Indoor unit temperature correction
To be used to correct indoor unit capacity only

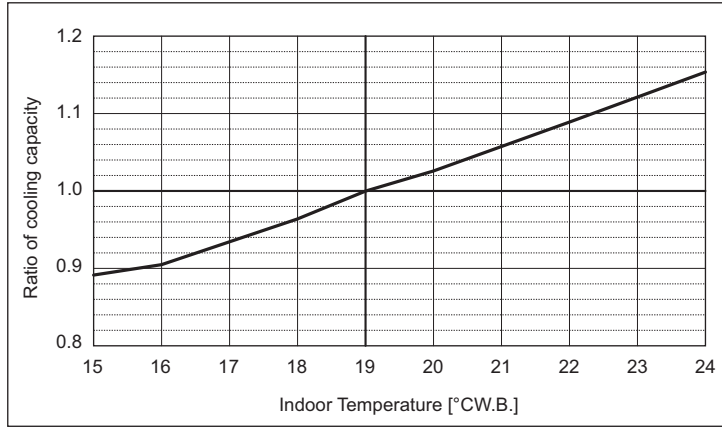

Outdoor unit temperature correction

To be used to correct outdoor unit only

Outdoor unit capacity is NOT affected by the indoor temperature.

Outdoor unit power input is affected by the indoor and outdoor temperatures. Please consult the sales office for details.

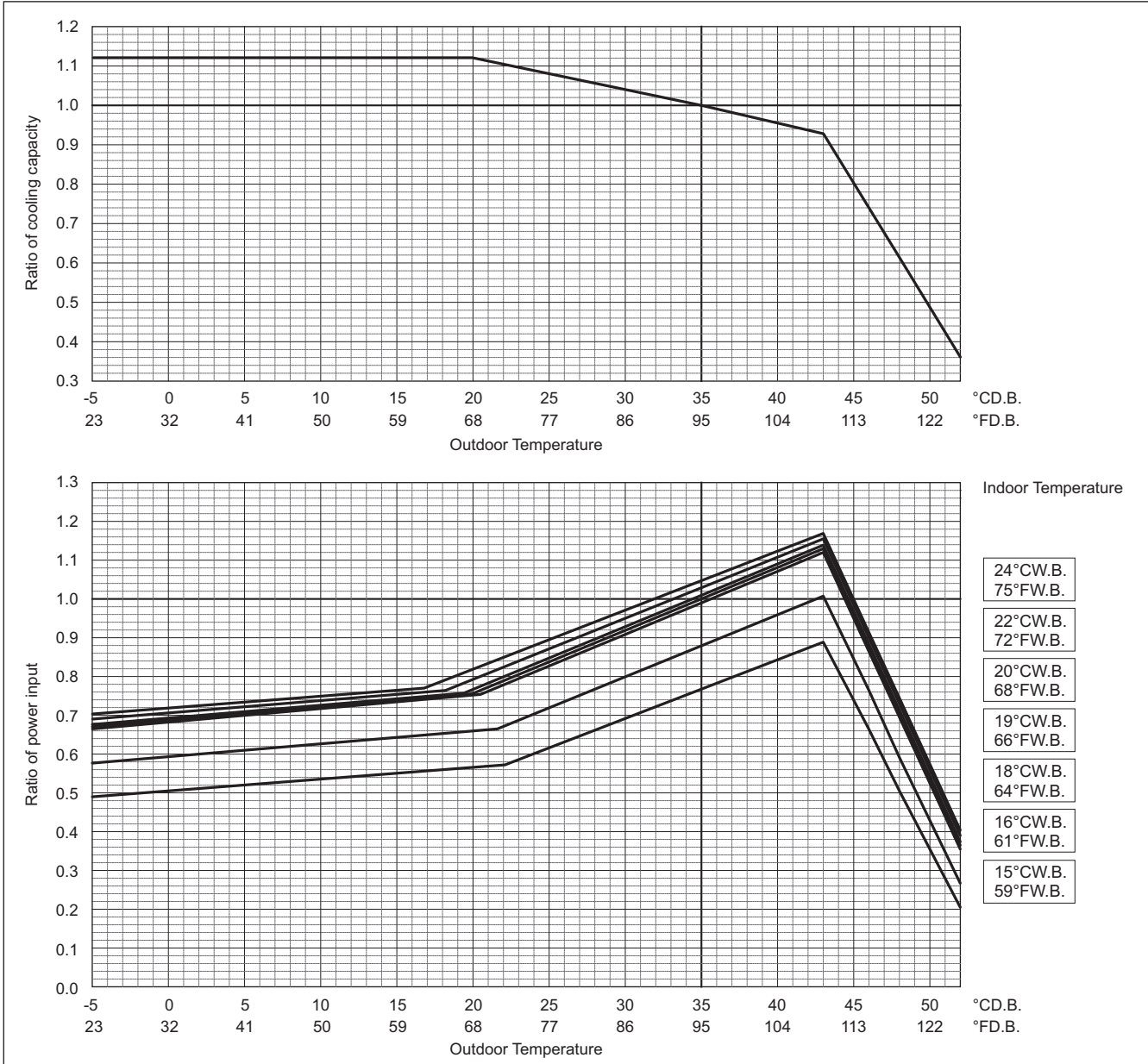

Capacity Priority Mode

| PUHY- | | P850YSNW-A1 | P900YSNW-A1 | P950YSNW-A1 |
|------------------|-------|-------------|-------------|-------------|
| Heating Capacity | kW | 108.0 | 113.0 | 119.5 |
| | BTU/h | 368,500 | 385,600 | 407,700 |
| Input | kW | 27.76 | 29.12 | 28.38 |

| PUHY- | | P1000YSNW-A1 | P1050YSNW-A1 | P1100YSNW-A1 |
|------------------|-------|--------------|--------------|--------------|
| Heating Capacity | kW | 127.0 | 132.0 | 140.0 |
| | BTU/h | 433,300 | 450,400 | 477,700 |
| Input | kW | 31.05 | 33.08 | 34.22 |

| PUHY- | | P1150YSNW-A1 | P1200YSNW-A1 | P1250YSNW-A1 |
|------------------|-------|--------------|--------------|--------------|
| Heating Capacity | kW | 145.0 | 150.0 | 156.5 |
| | BTU/h | 494,700 | 511,800 | 534,000 |
| Input | kW | 36.25 | 38.36 | 40.12 |

| PUHY- | | P1300YSNW-A1 | P1350YSNW-A1 |
|------------------|-------|--------------|--------------|
| Heating Capacity | kW | 163.0 | 168.0 |
| | BTU/h | 556,200 | 573,200 |
| Input | kW | 41.90 | 43.29 |

Indoor unit temperature correction

To be used to correct indoor unit capacity only

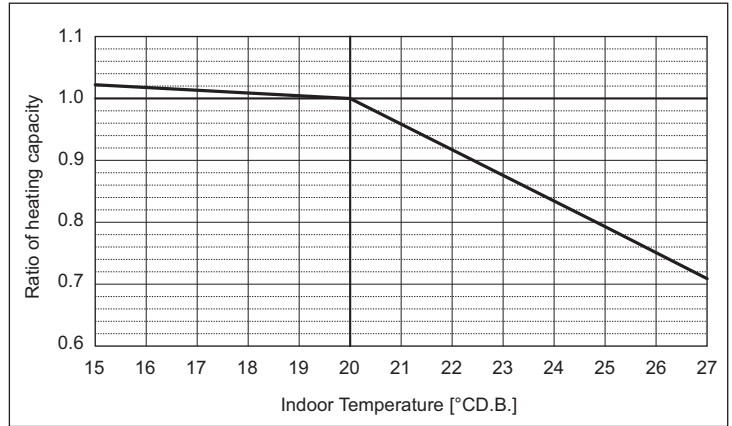

Outdoor unit temperature correction

To be used to correct outdoor unit only

Outdoor unit capacity is NOT affected by the indoor temperature.

Outdoor unit power input is affected by the indoor and outdoor temperatures. Please consult the sales office for details.

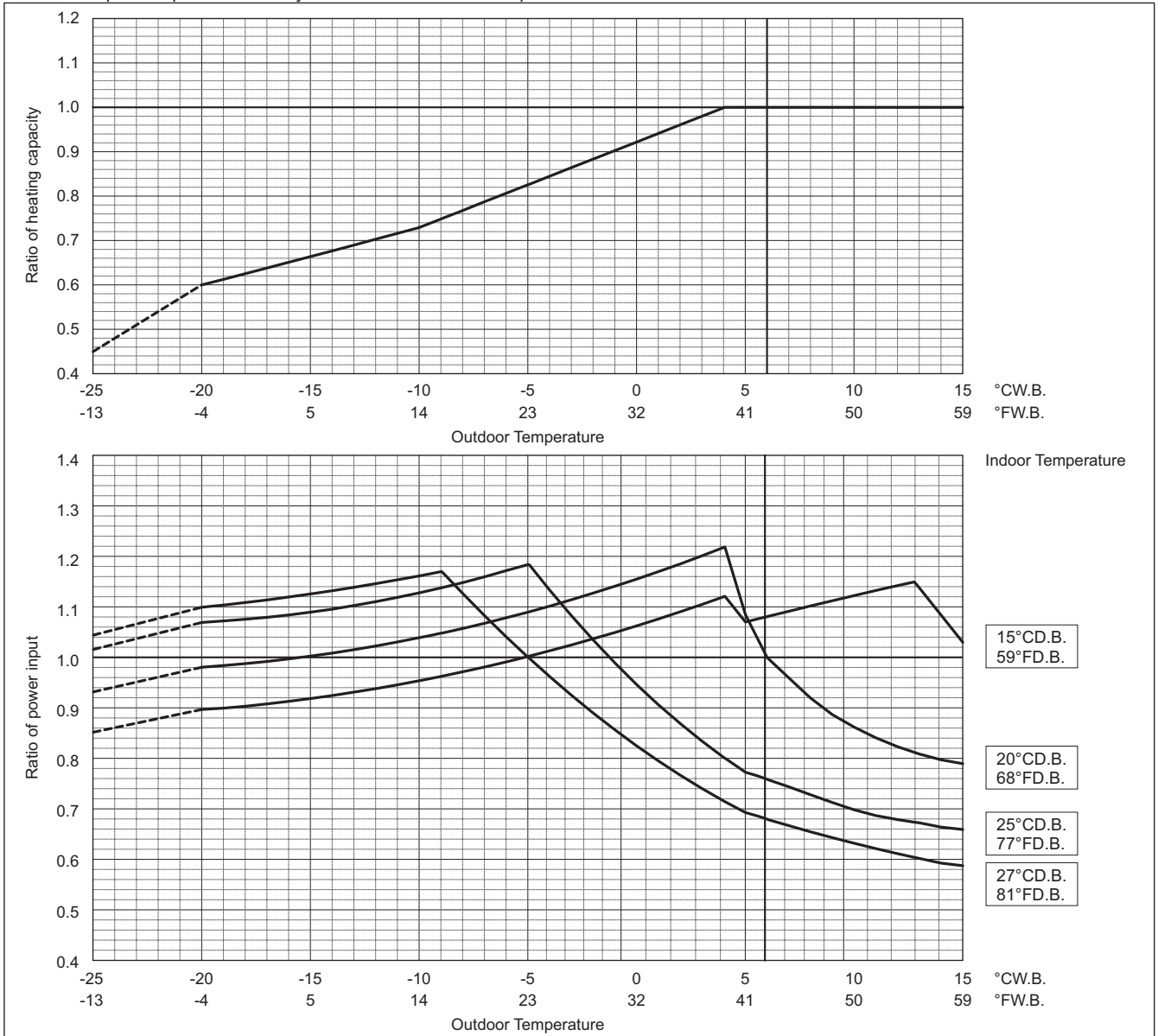

Values in the heating temperature correction diagram in the range below -20°C (-4°F) are reference values and not guaranteed values. Do not use these reference values for selecting outdoor unit models.

When applying product below -20°C (-4°F), consult your design engineer for cold climate application best practices, including the use of a backup source for heating.

8-3. Correction by total indoor

CITY MULTI system has different capacities and inputs when many combinations of indoor units with different total capacities are connected. Using following tables, the maximum capacity can be found to ensure the system is installed with enough capacity for a particular application.

PUHY-P-Y(S)NW-A1

| PUHY-P200YNW-A1 | | |
|------------------|-------|--------|
| Cooling Capacity | kW | 22.4 |
| | BTU/h | 76,400 |
| Input | kW | 4.81 |

| PUHY-P200YNW-A1 | | |
|------------------|-------|--------|
| Heating Capacity | kW | 25.0 |
| | BTU/h | 85,300 |
| Input | kW | 5.10 |

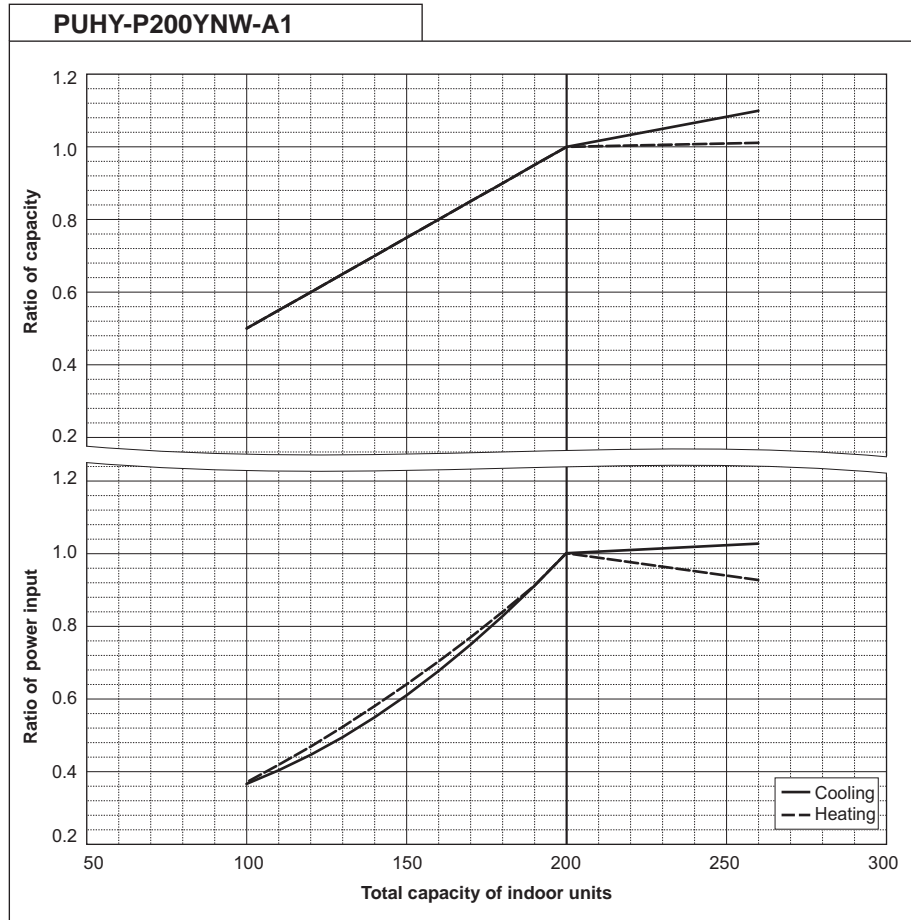

| PUHY-P250YNW-A1 | | |
|------------------|-------|--------|
| Cooling Capacity | kW | 28.0 |
| | BTU/h | 95,500 |
| Input | kW | 7.14 |

| PUHY-P250YNW-A1 | | |
|------------------|-------|---------|
| Heating Capacity | kW | 31.5 |
| | BTU/h | 107,500 |
| Input | kW | 7.20 |

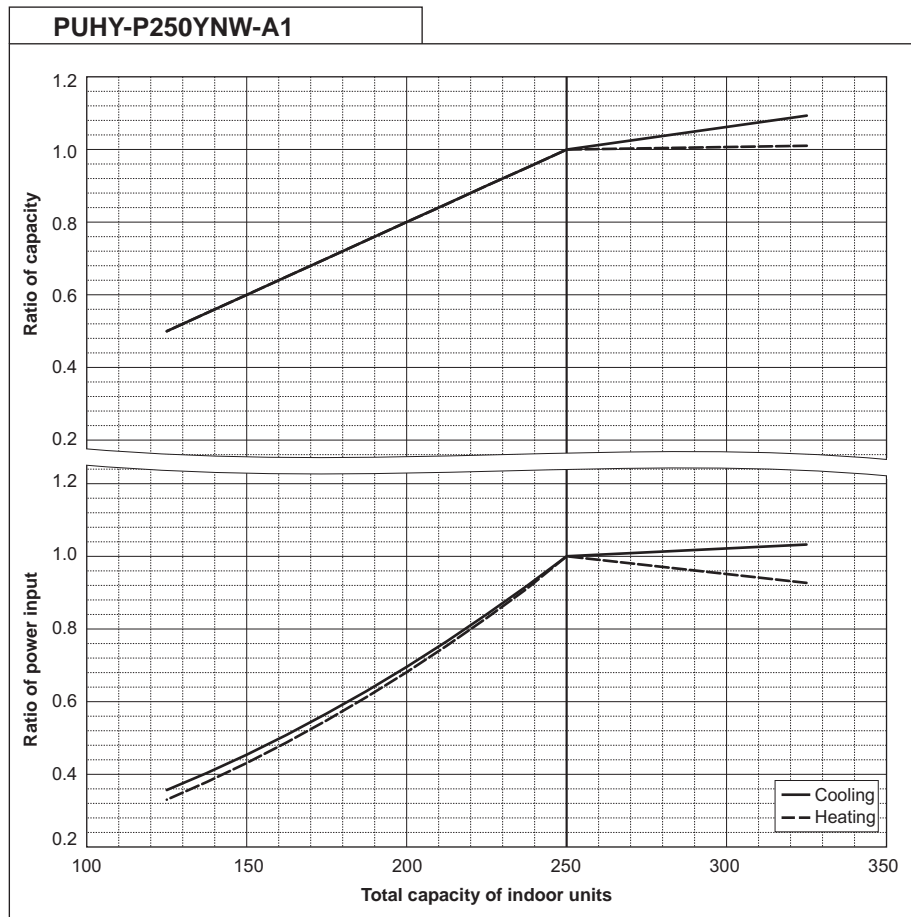

| PUHY-P300YNW-A1 | | |
|------------------|-------|---------|
| Cooling Capacity | kW | 33.5 |
| | BTU/h | 114,300 |
| Input | kW | 8.79 |

| PUHY-P300YNW-A1 | | |
|------------------|-------|---------|
| Heating Capacity | kW | 37.5 |
| | BTU/h | 128,000 |
| Input | kW | 8.46 |

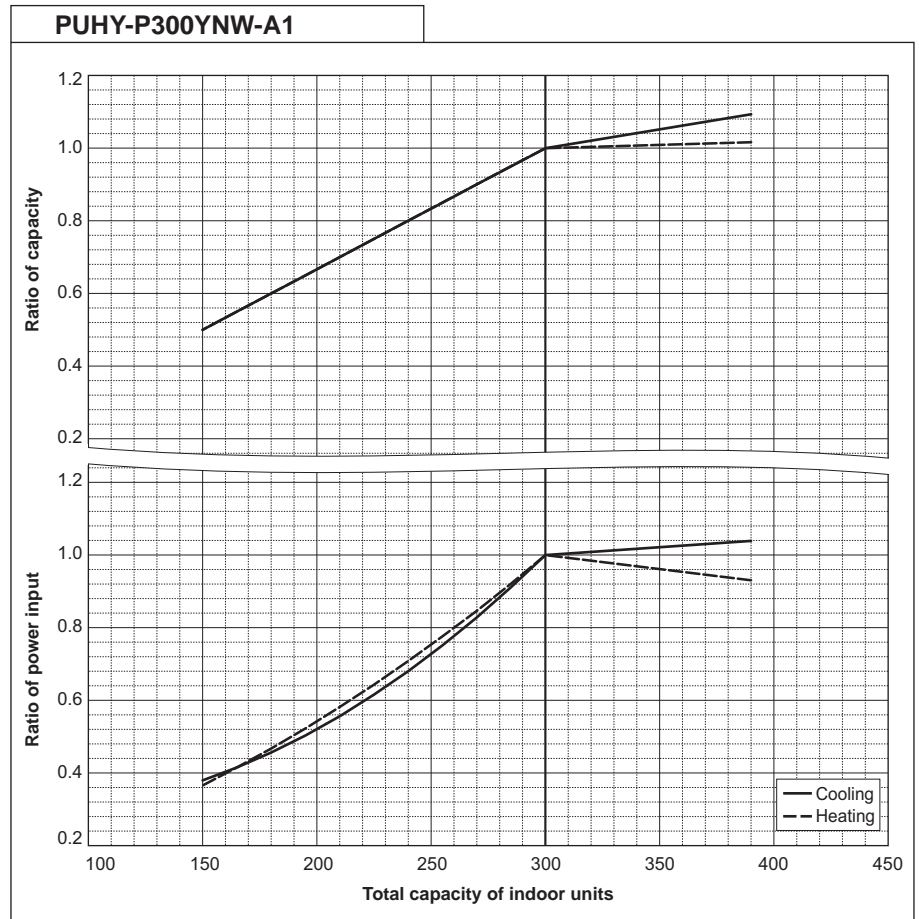

| PUHY-P350YNW-A1 | | |
|------------------|-------|---------|
| Cooling Capacity | kW | 40.0 |
| | BTU/h | 136,500 |
| Input | kW | 10.95 |

| PUHY-P350YNW-A1 | | |
|------------------|-------|---------|
| Heating Capacity | kW | 45.0 |
| | BTU/h | 153,500 |
| Input | kW | 10.39 |

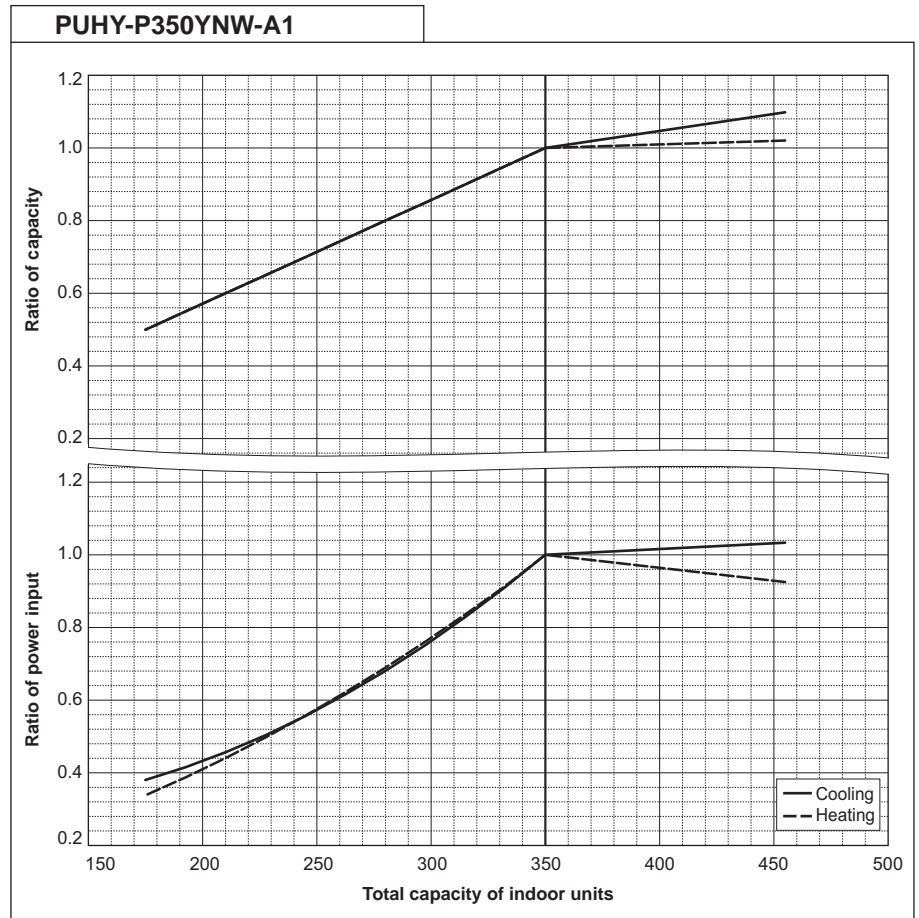

| PUHY-P400YNW-A1 | | |
|------------------|-------|---------|
| Cooling Capacity | kW | 45.0 |
| | BTU/h | 153,500 |
| Input | kW | 14.19 |

| PUHY-P400YNW-A1 | | |
|------------------|-------|---------|
| Heating Capacity | kW | 50.0 |
| | BTU/h | 170,600 |
| Input | kW | 12.37 |

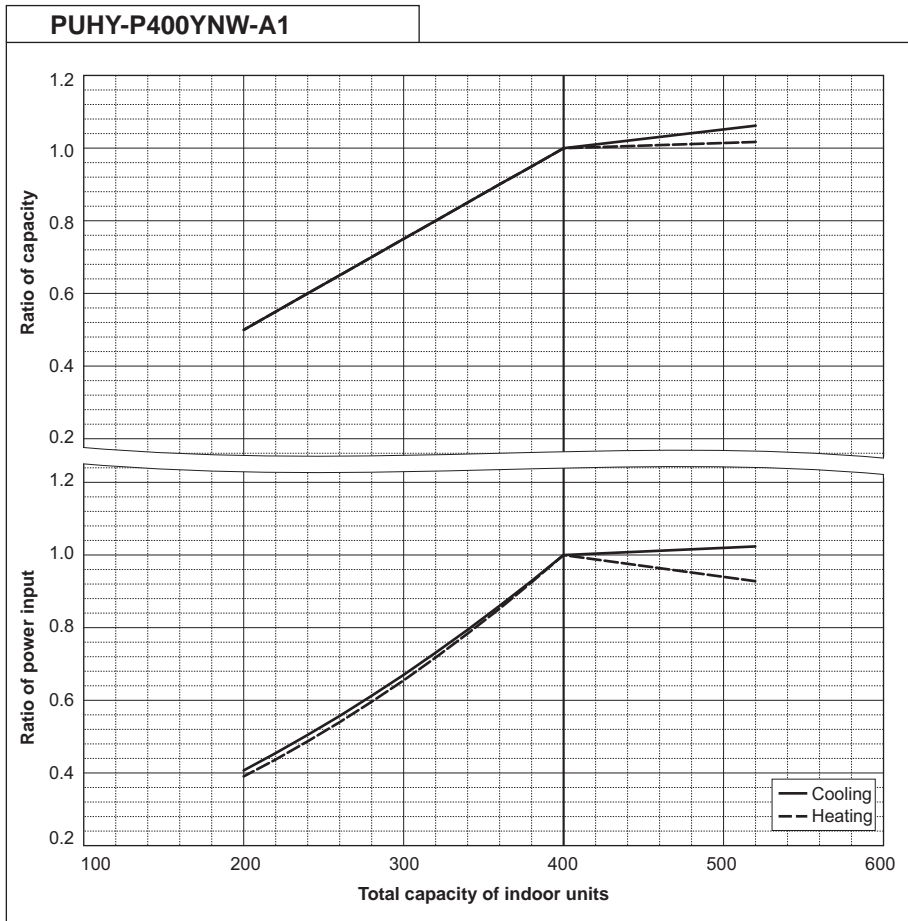

| PUHY-P450YNW-A1 | | |
|------------------|-------|---------|
| Cooling Capacity | kW | 50.0 |
| | BTU/h | 170,600 |
| Input | kW | 14.57 |

| PUHY-P450YNW-A1 | | |
|------------------|-------|---------|
| Heating Capacity | kW | 56.0 |
| | BTU/h | 191,100 |
| Input | kW | 14.00 |

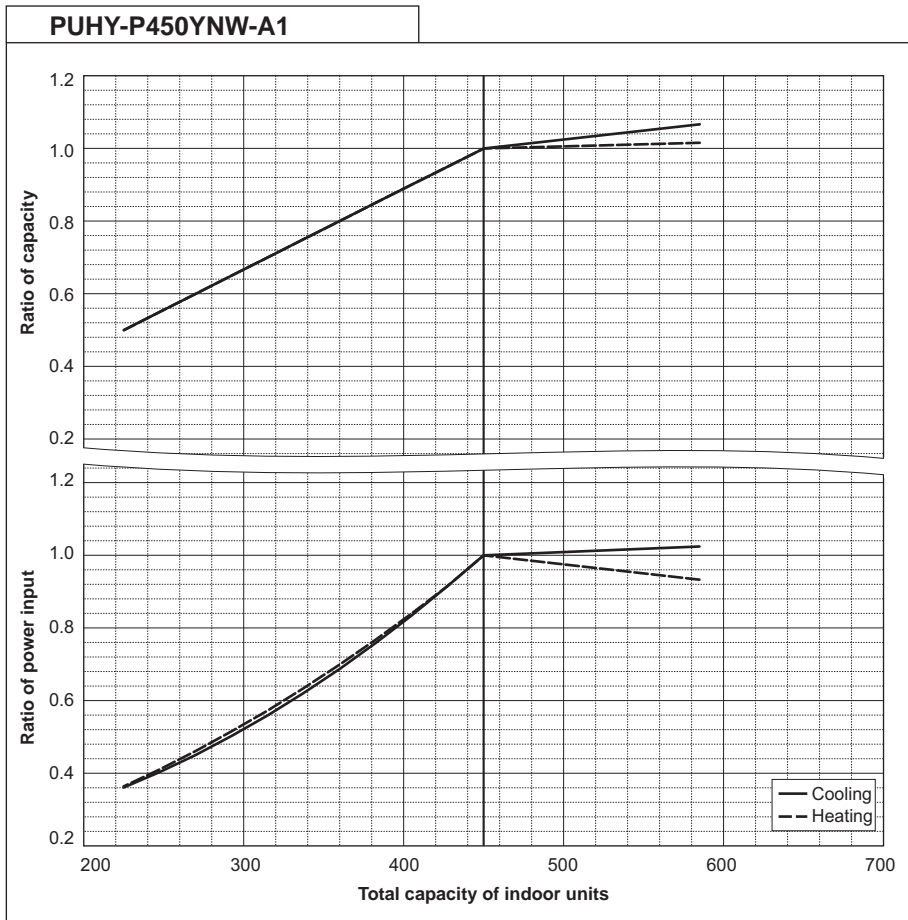

| PUHY-P500YNW-A1 | | |
|------------------|-------|---------|
| Cooling Capacity | kW | 56.0 |
| | BTU/h | 191,100 |
| Input | kW | 17.55 |

| PUHY-P500YNW-A1 | | |
|------------------|-------|---------|
| Heating Capacity | kW | 63.0 |
| | BTU/h | 215,000 |
| Input | kW | 15.98 |

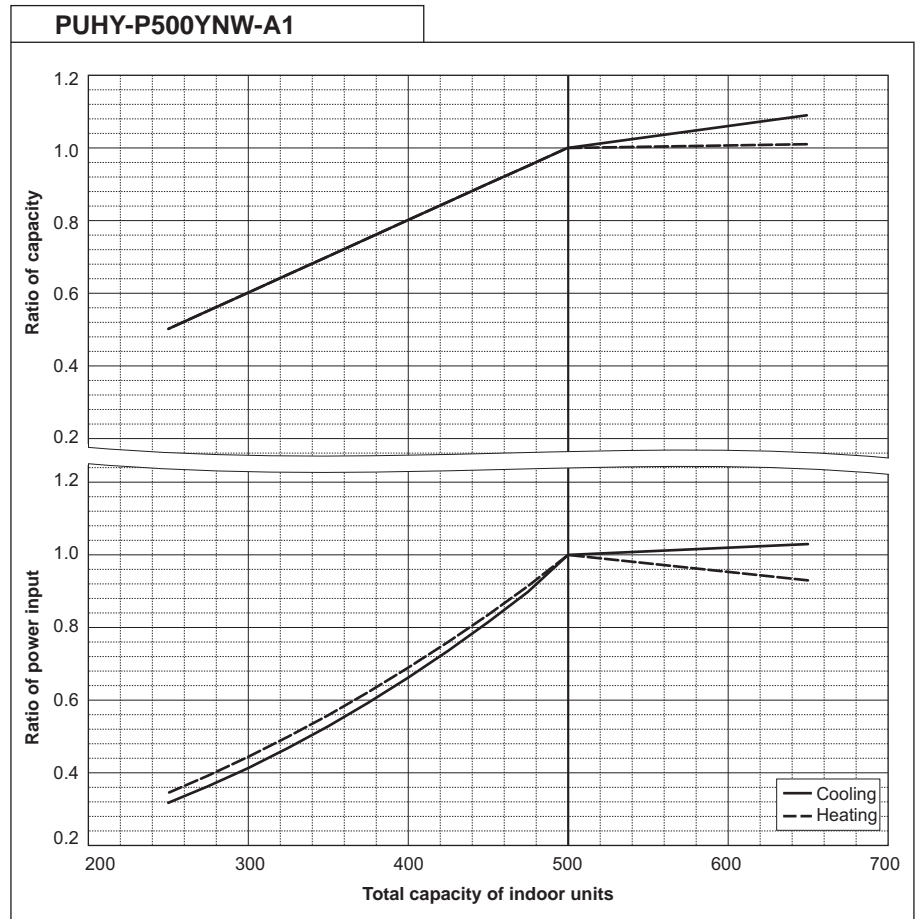

| PUHY-P400YSNW-A1 | | |
|------------------|-------|---------|
| Cooling Capacity | kW | 45.0 |
| | BTU/h | 153,500 |
| Input | kW | 9.97 |

| PUHY-P400YSNW-A1 | | |
|------------------|-------|---------|
| Heating Capacity | kW | 50.0 |
| | BTU/h | 170,600 |
| Input | kW | 10.52 |

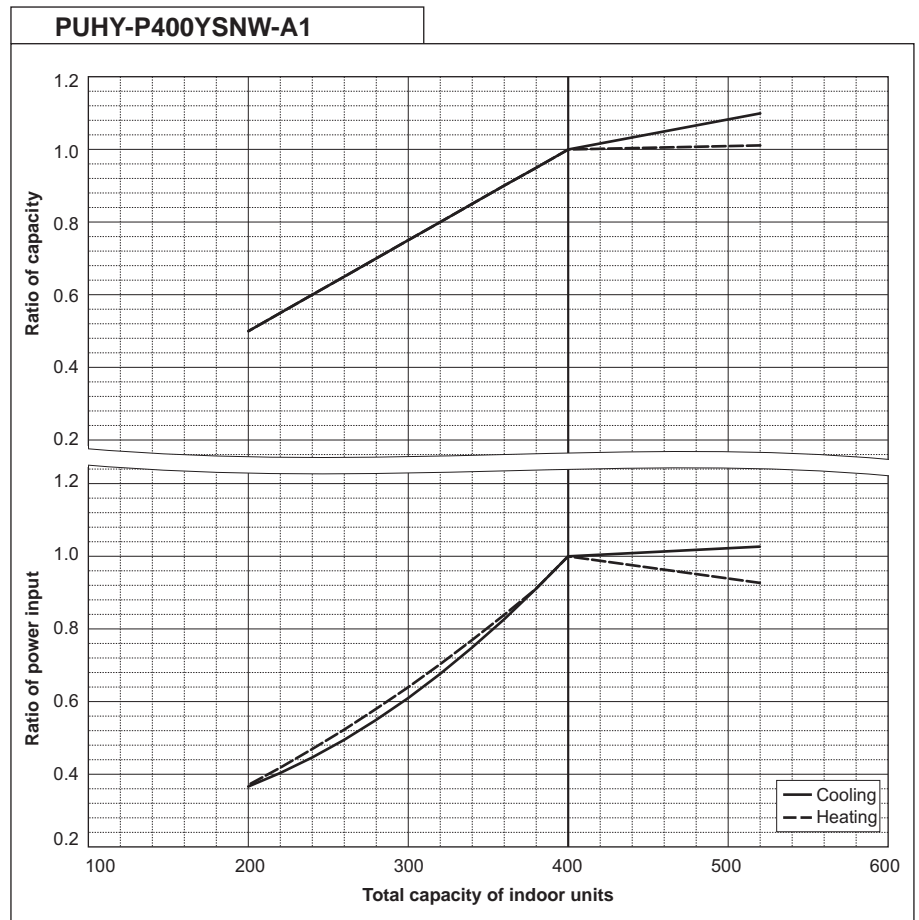

PUHY-P-Y(S)NW-A1

| PUHY-P450YSNW-A1 | | |
|------------------|-------|---------|
| Cooling Capacity | kW | 50.0 |
| | BTU/h | 170,600 |
| Input | kW | 12.16 |

| PUHY-P450YSNW-A1 | | |
|------------------|-------|---------|
| Heating Capacity | kW | 56.0 |
| | BTU/h | 191,100 |
| Input | kW | 12.55 |

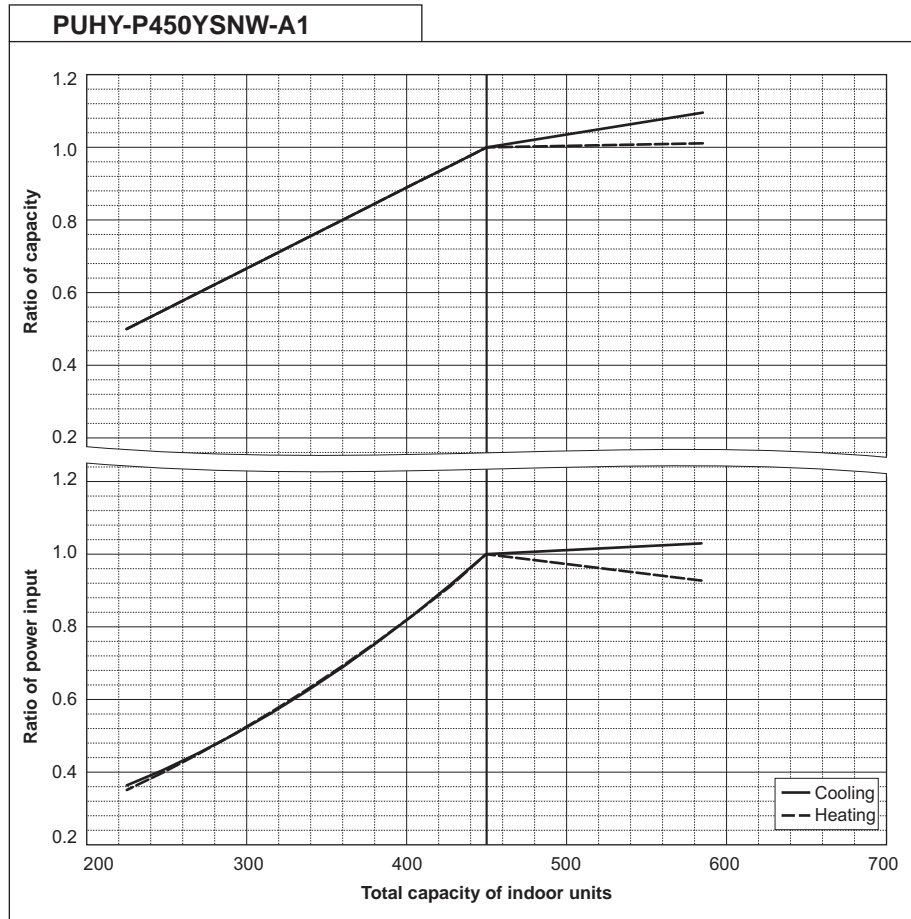

| PUHY-P500YSNW-A1 | | |
|------------------|-------|---------|
| Cooling Capacity | kW | 56.0 |
| | BTU/h | 191,100 |
| Input | kW | 14.73 |

| PUHY-P500YSNW-A1 | | |
|------------------|-------|---------|
| Heating Capacity | kW | 63.0 |
| | BTU/h | 215,000 |
| Input | kW | 14.89 |

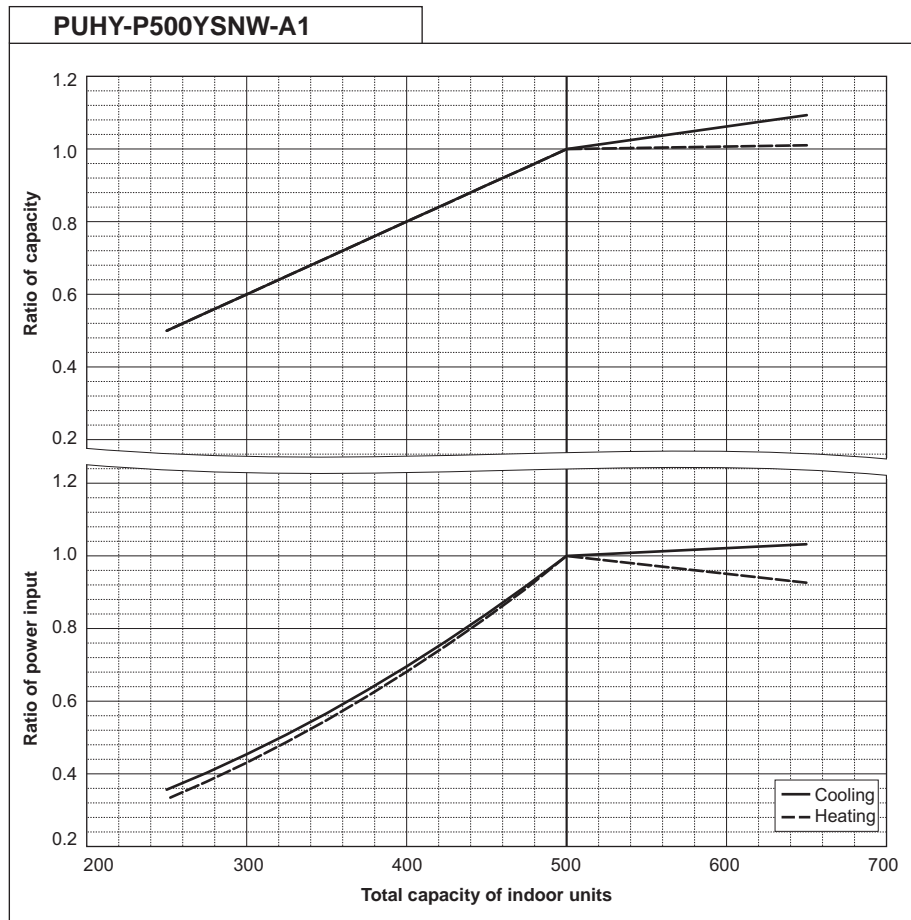

| PUHY-P550YSNW-A1 | | |
|------------------|-------|---------|
| Cooling Capacity | kW | 63.0 |
| | BTU/h | 215,000 |
| Input | kW | 16.84 |

| PUHY-P550YSNW-A1 | | |
|------------------|-------|---------|
| Heating Capacity | kW | 69.0 |
| | BTU/h | 235,400 |
| Input | kW | 16.15 |

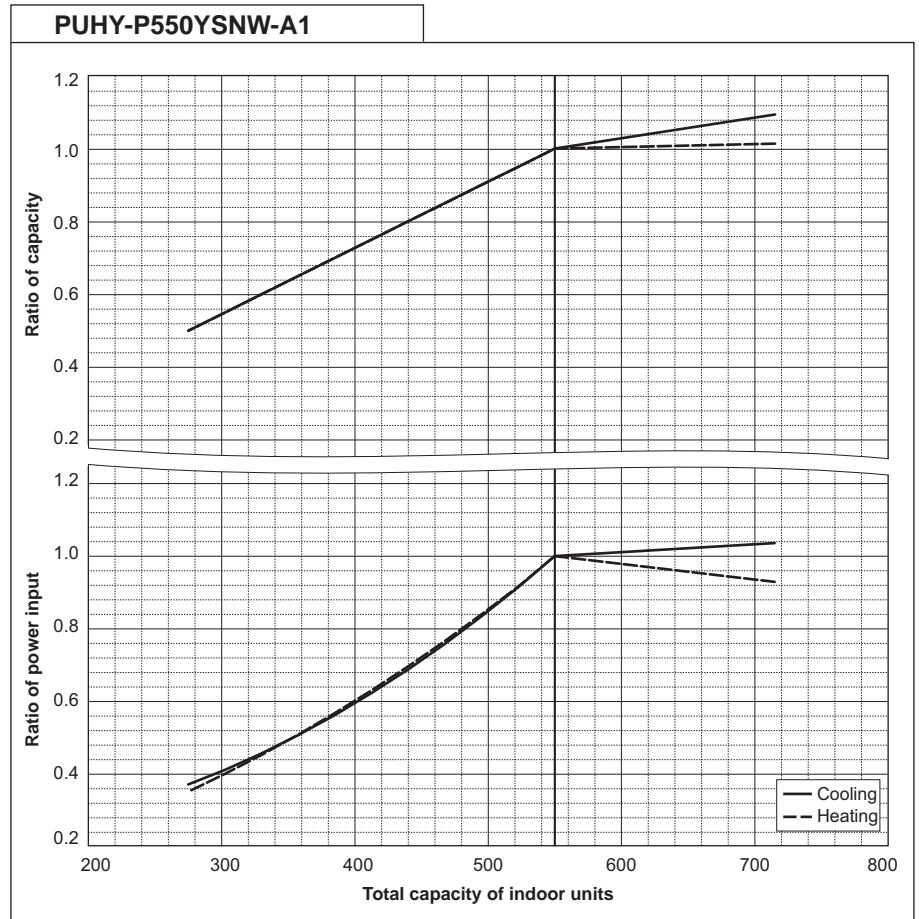

| PUHY-P600YSNW-A1 | | |
|------------------|-------|---------|
| Cooling Capacity | kW | 69.0 |
| | BTU/h | 235,400 |
| Input | kW | 18.69 |

| PUHY-P600YSNW-A1 | | |
|------------------|-------|---------|
| Heating Capacity | kW | 76.5 |
| | BTU/h | 261,000 |
| Input | kW | 17.83 |

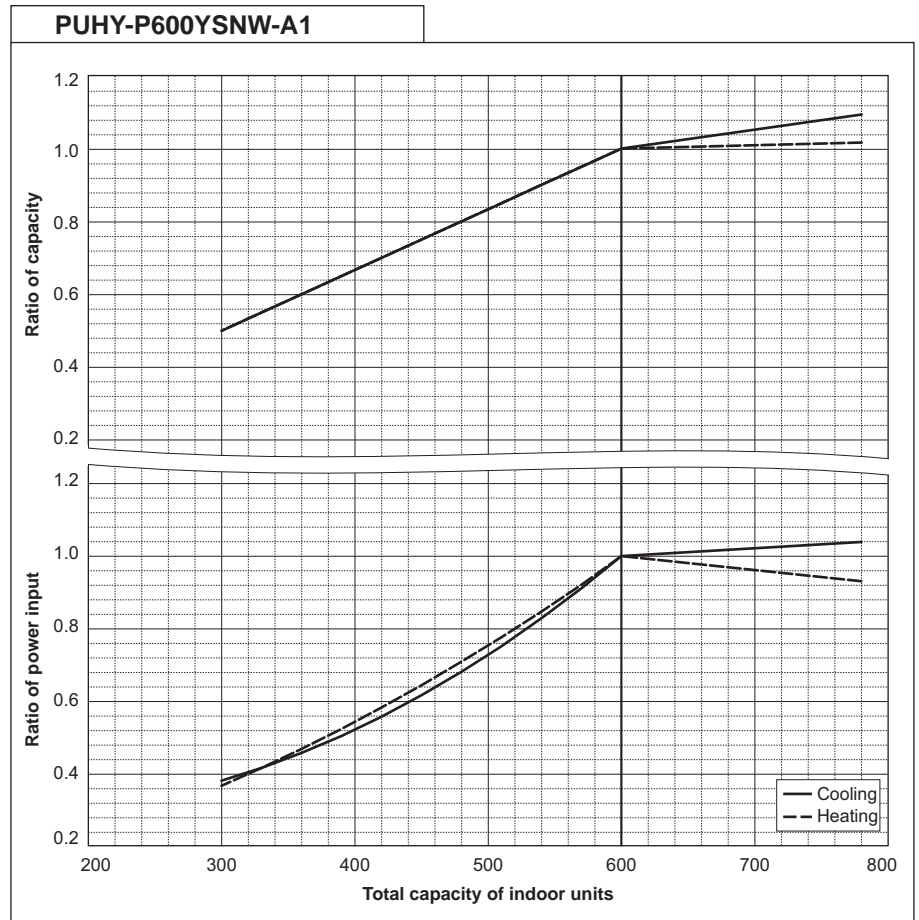

PUHY-P-Y(S)NW-A1

| PUHY-P650YSNW-A1 | | |
|------------------|-------|---------|
| Cooling Capacity | kW | 73.0 |
| | BTU/h | 249,100 |
| Input | kW | 21.79 |

| PUHY-P650YSNW-A1 | | |
|------------------|-------|---------|
| Heating Capacity | kW | 81.5 |
| | BTU/h | 278,100 |
| Input | kW | 20.17 |

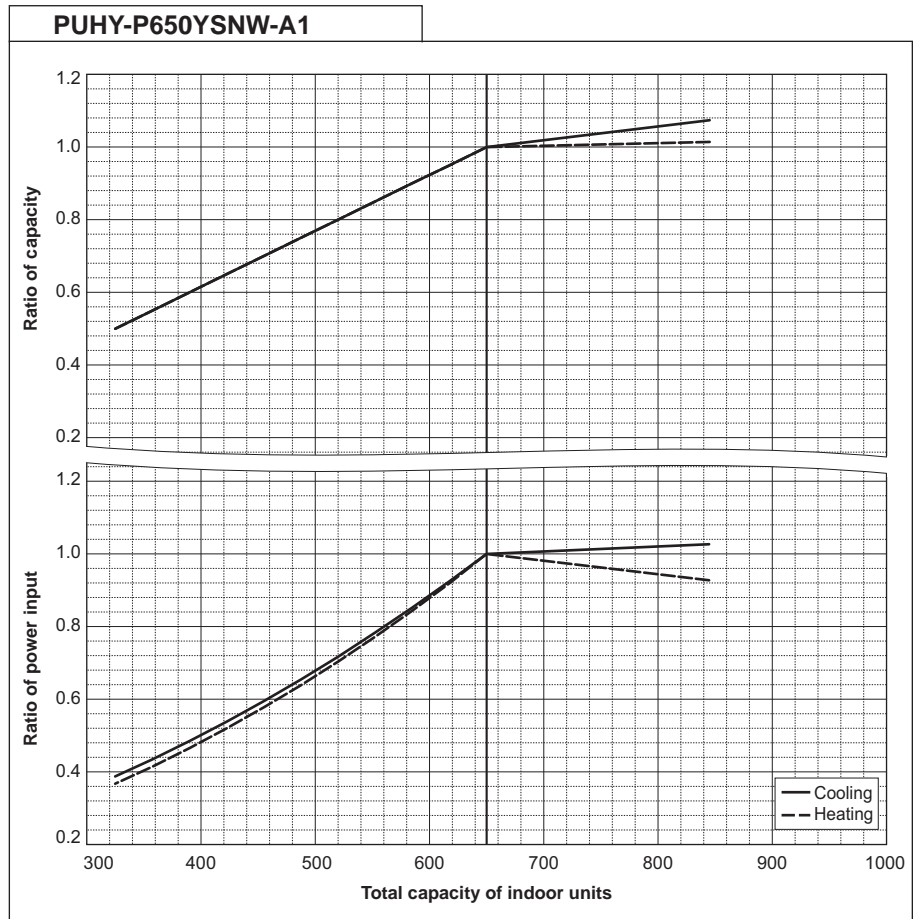

| PUHY-P700YSNW-A1 | | |
|------------------|-------|---------|
| Cooling Capacity | kW | 80.0 |
| | BTU/h | 273,000 |
| Input | kW | 22.59 |

| PUHY-P700YSNW-A1 | | |
|------------------|-------|---------|
| Heating Capacity | kW | 88.0 |
| | BTU/h | 300,300 |
| Input | kW | 20.95 |

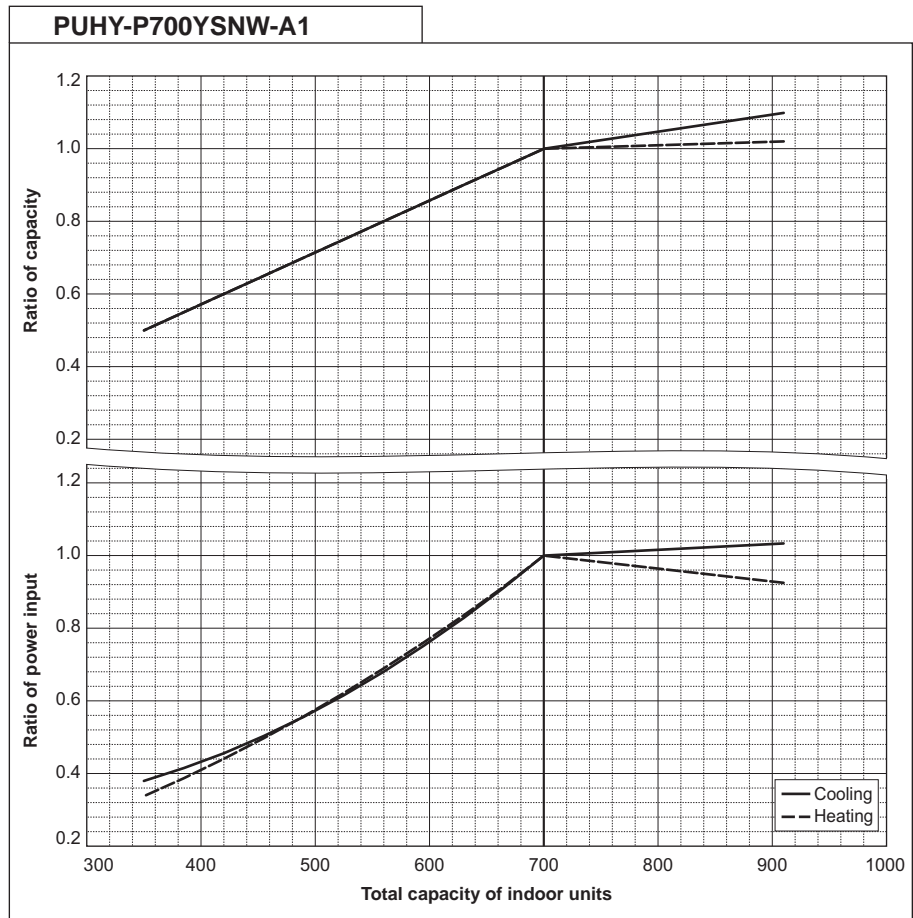

| PUHY-P750YSNW-A1 | | |
|------------------|-------|---------|
| Cooling Capacity | kW | 85.0 |
| | BTU/h | 290,000 |
| Input | kW | 25.83 |

| PUHY-P750YSNW-A1 | | |
|------------------|-------|---------|
| Heating Capacity | kW | 95.0 |
| | BTU/h | 324,100 |
| Input | kW | 23.45 |

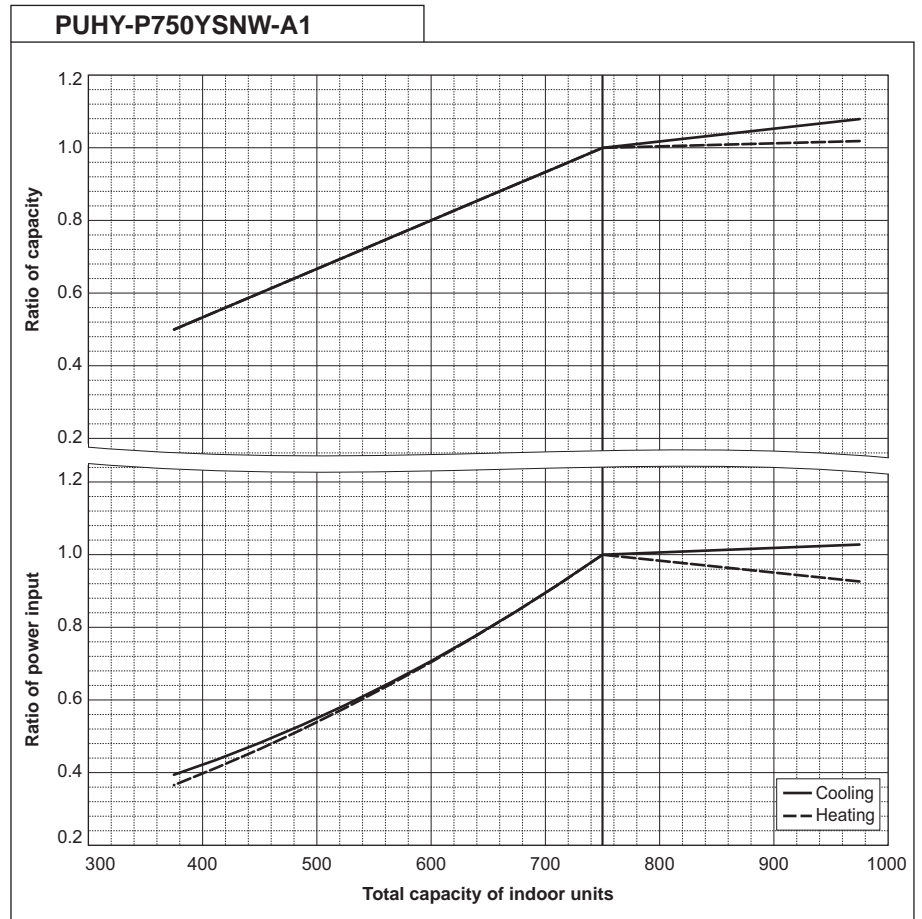

| PUHY-P800YSNW-A1 | | |
|------------------|-------|---------|
| Cooling Capacity | kW | 90.0 |
| | BTU/h | 307,100 |
| Input | kW | 26.31 |

| PUHY-P800YSNW-A1 | | |
|------------------|-------|---------|
| Heating Capacity | kW | 100.0 |
| | BTU/h | 341,200 |
| Input | kW | 24.87 |

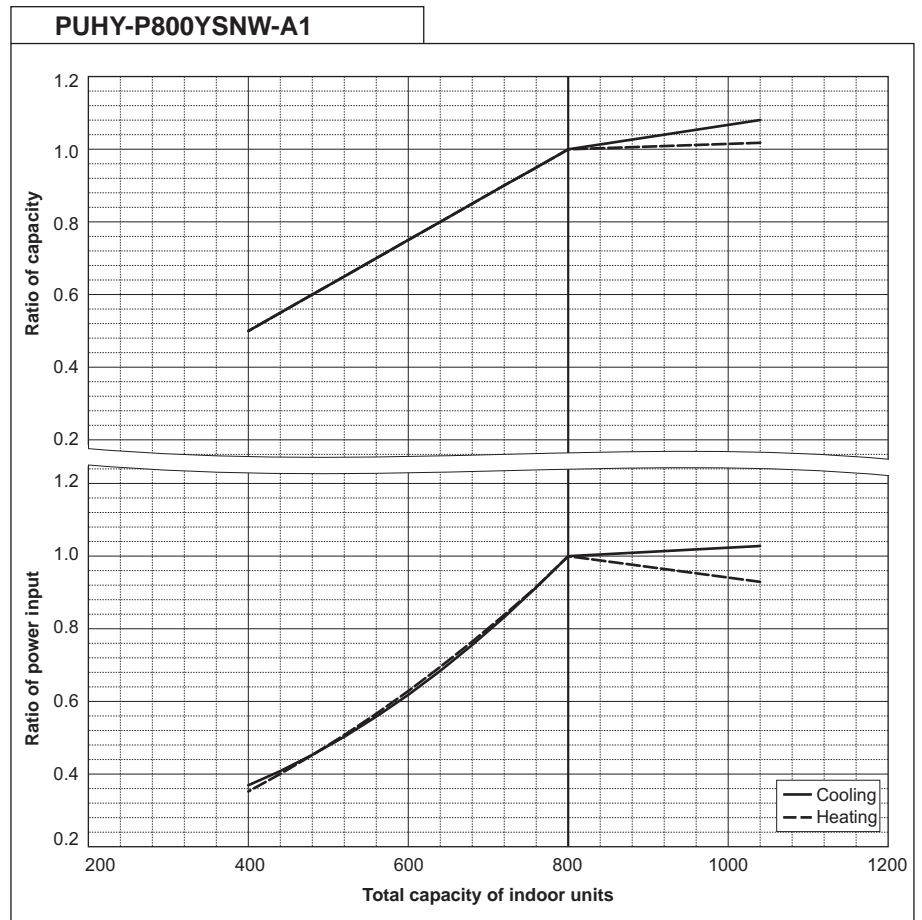

PUHY-P-Y(S)NW-A1

| PUHY-P850YSNW-A1 | | |
|------------------|-------|---------|
| Cooling Capacity | kW | 96.0 |
| | BTU/h | 327,600 |
| Input | kW | 30.00 |

| PUHY-P850YSNW-A1 | | |
|------------------|-------|---------|
| Heating Capacity | kW | 108.0 |
| | BTU/h | 368,500 |
| Input | kW | 27.76 |

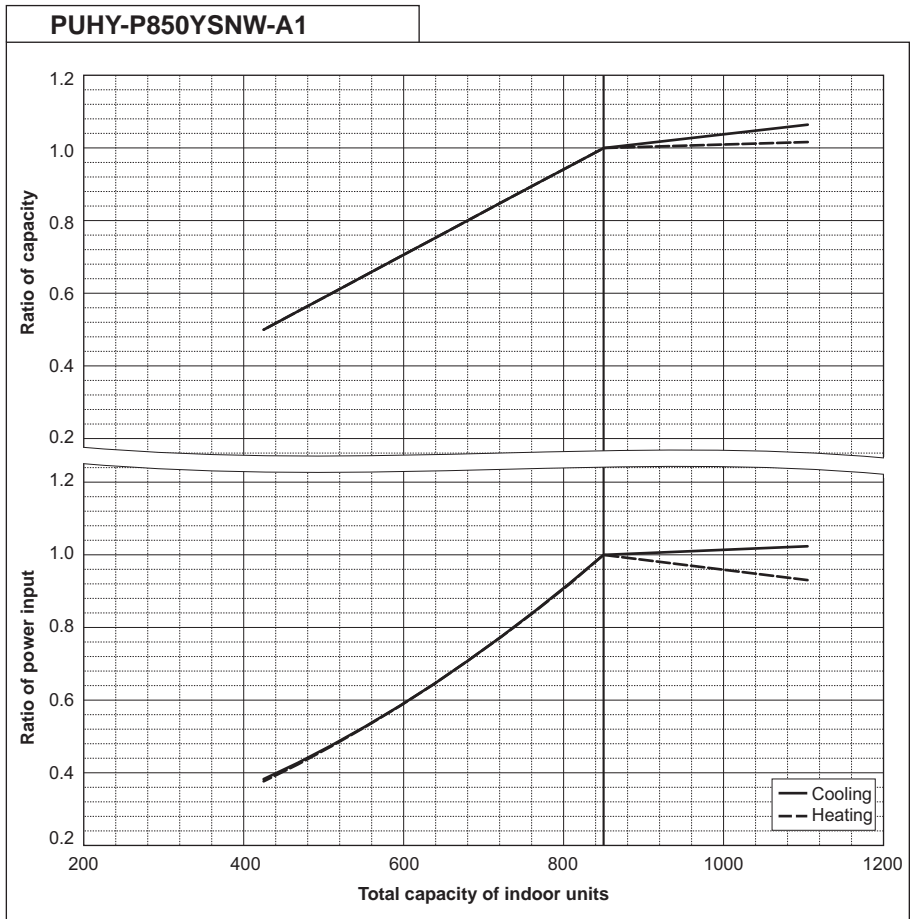

| PUHY-P900YSNW-A1 | | |
|------------------|-------|---------|
| Cooling Capacity | kW | 101.0 |
| | BTU/h | 344,600 |
| Input | kW | 30.42 |

| PUHY-P900YSNW-A1 | | |
|------------------|-------|---------|
| Heating Capacity | kW | 113.0 |
| | BTU/h | 385,600 |
| Input | kW | 29.12 |

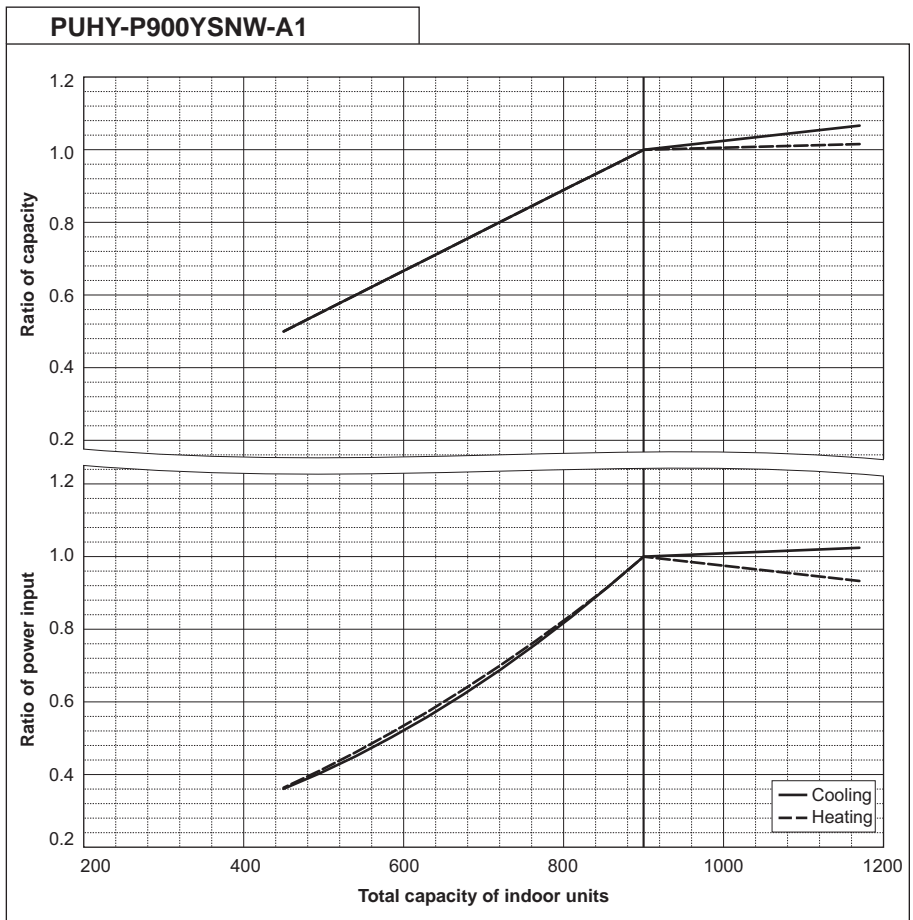

| PUHY-P950YSNW-A1 | | |
|------------------|-------|---------|
| Cooling Capacity | kW | 108.0 |
| | BTU/h | 368,500 |
| Input | kW | 30.00 |

| PUHY-P950YSNW-A1 | | |
|------------------|-------|---------|
| Heating Capacity | kW | 119.5 |
| | BTU/h | 407,700 |
| Input | kW | 28.38 |

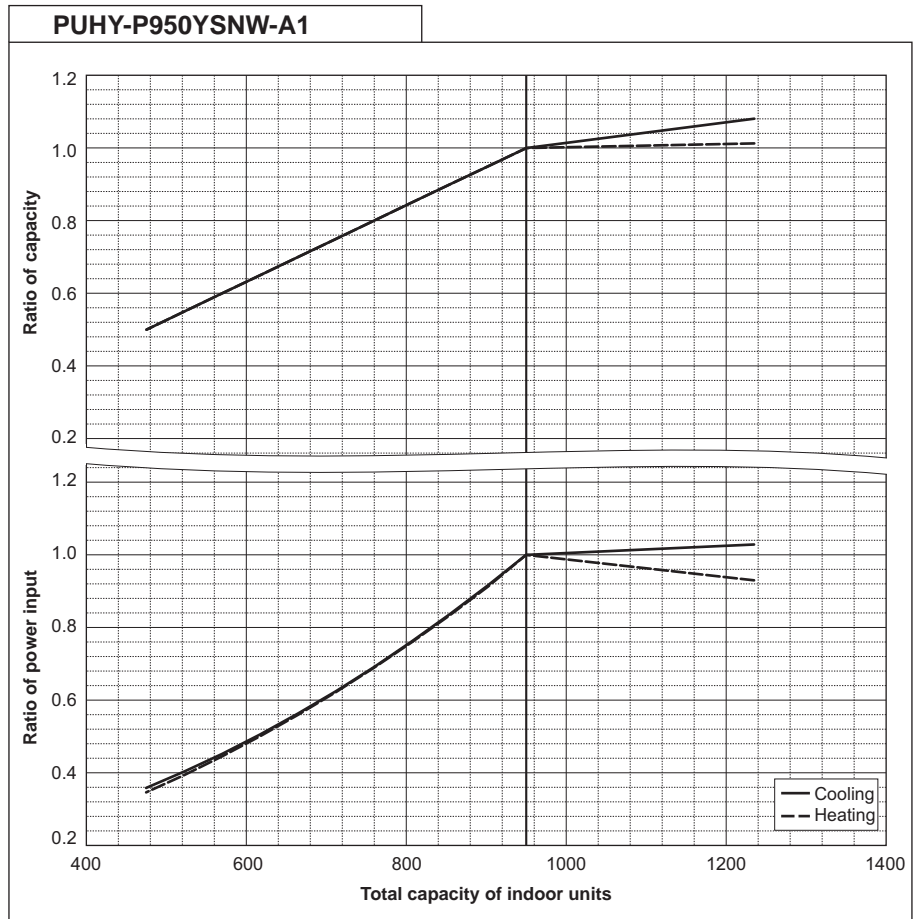

| PUHY-P1000YSNW-A1 | | |
|-------------------|-------|---------|
| Cooling Capacity | kW | 113.0 |
| | BTU/h | 385,600 |
| Input | kW | 33.13 |

| PUHY-P1000YSNW-A1 | | |
|-------------------|-------|---------|
| Heating Capacity | kW | 127.0 |
| | BTU/h | 433,300 |
| Input | kW | 31.05 |

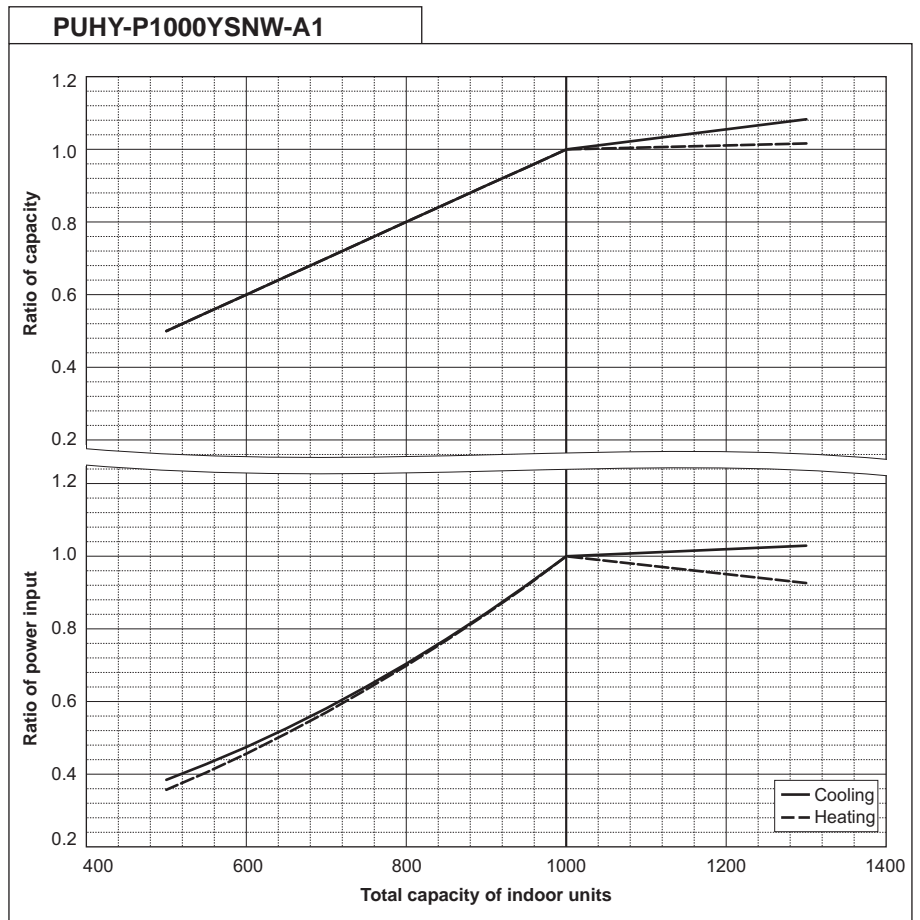

| PUHY-P1050YSNW-A1 | | |
|-------------------|-------|---------|
| Cooling Capacity | kW | 118.0 |
| | BTU/h | 402,600 |
| Input | kW | 36.41 |

| PUHY-P1050YSNW-A1 | | |
|-------------------|-------|---------|
| Heating Capacity | kW | 132.0 |
| | BTU/h | 450,400 |
| Input | kW | 33.08 |

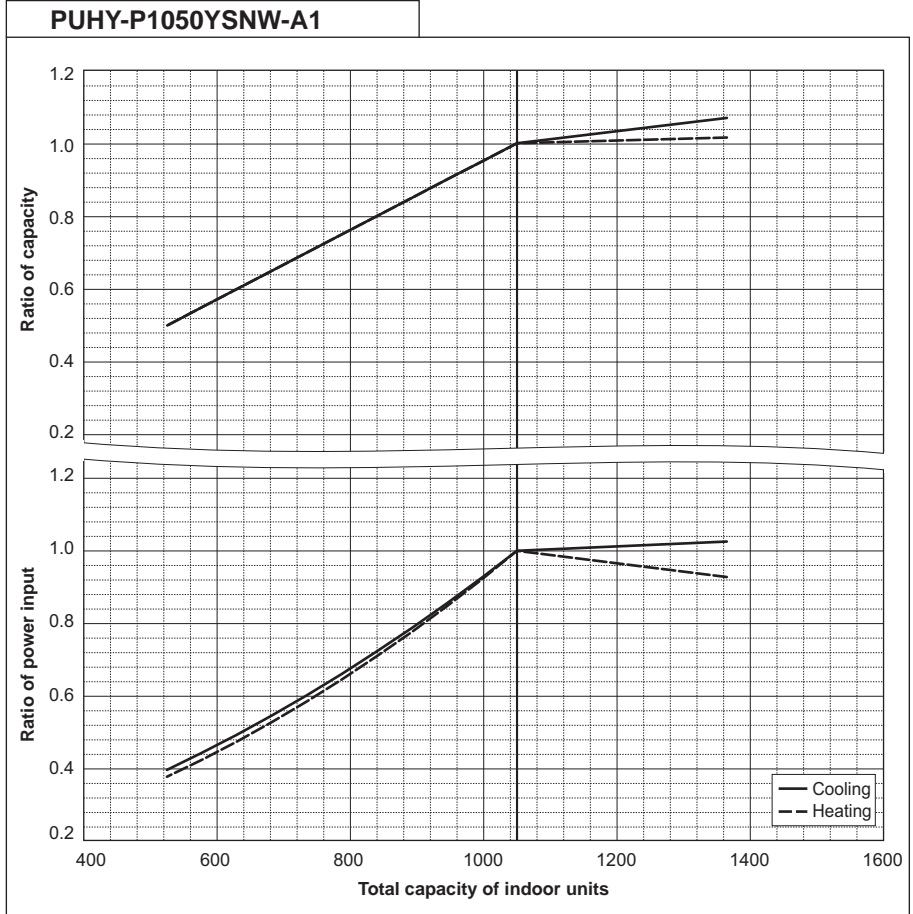

| PUHY-P1100YSNW-A1 | | |
|-------------------|-------|---------|
| Cooling Capacity | kW | 124.0 |
| | BTU/h | 423,100 |
| Input | kW | 36.79 |

| PUHY-P1100YSNW-A1 | | |
|-------------------|-------|---------|
| Heating Capacity | kW | 140.0 |
| | BTU/h | 477,700 |
| Input | kW | 34.22 |

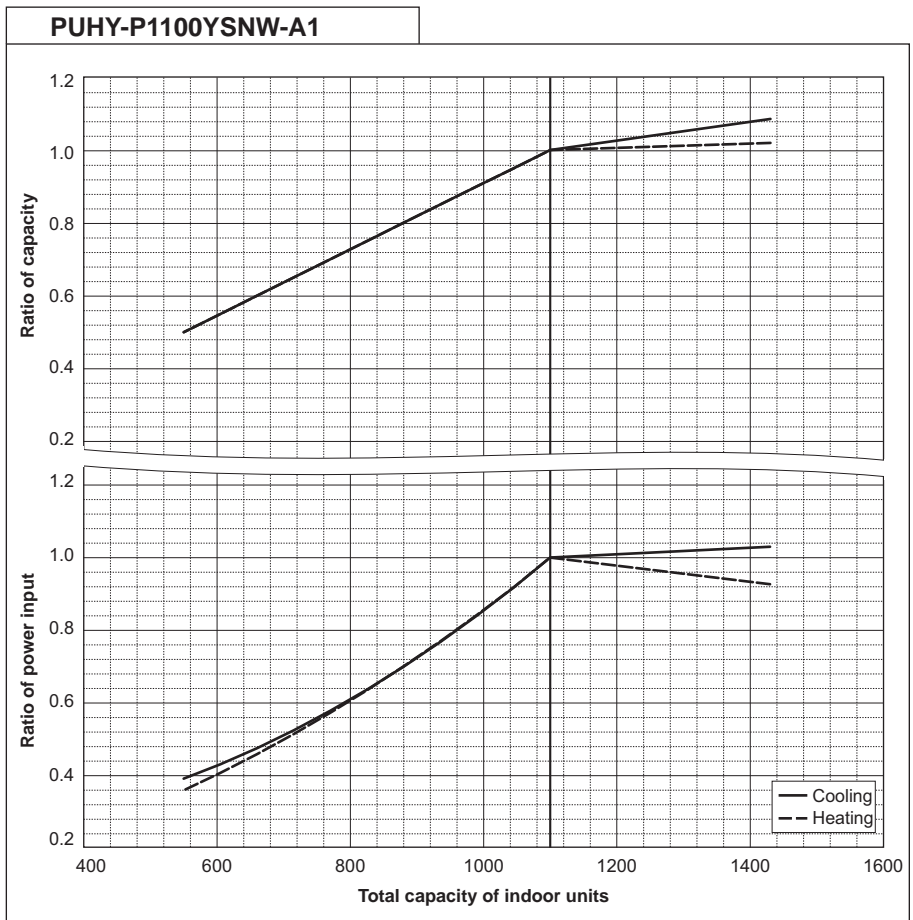

| PUHY-P1150YSNW-A1 | | |
|-------------------|-------|---------|
| Cooling Capacity | kW | 130.0 |
| | BTU/h | 443,600 |
| Input | kW | 40.49 |

| PUHY-P1150YSNW-A1 | | |
|-------------------|-------|---------|
| Heating Capacity | kW | 145.0 |
| | BTU/h | 494,700 |
| Input | kW | 36.25 |

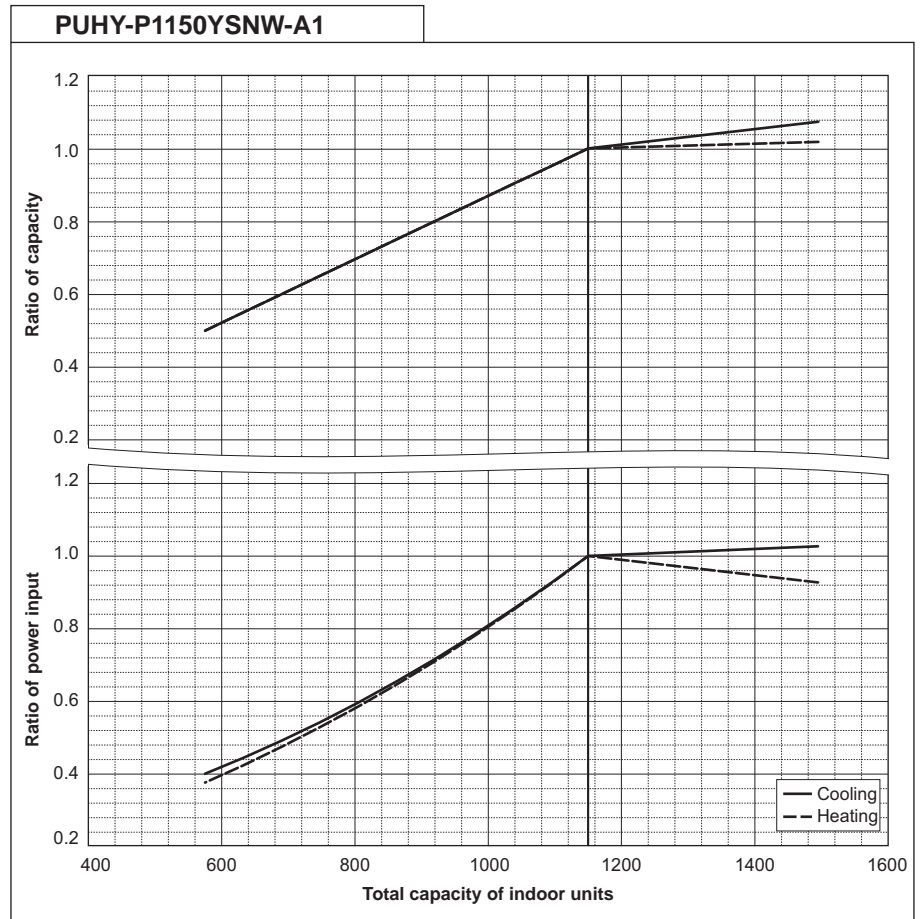

| PUHY-P1200YSNW-A1 | | |
|-------------------|-------|---------|
| Cooling Capacity | kW | 136.0 |
| | BTU/h | 464,400 |
| Input | kW | 44.29 |

| PUHY-P1200YSNW-A1 | | |
|-------------------|-------|---------|
| Heating Capacity | kW | 150.0 |
| | BTU/h | 511,800 |
| Input | kW | 38.36 |

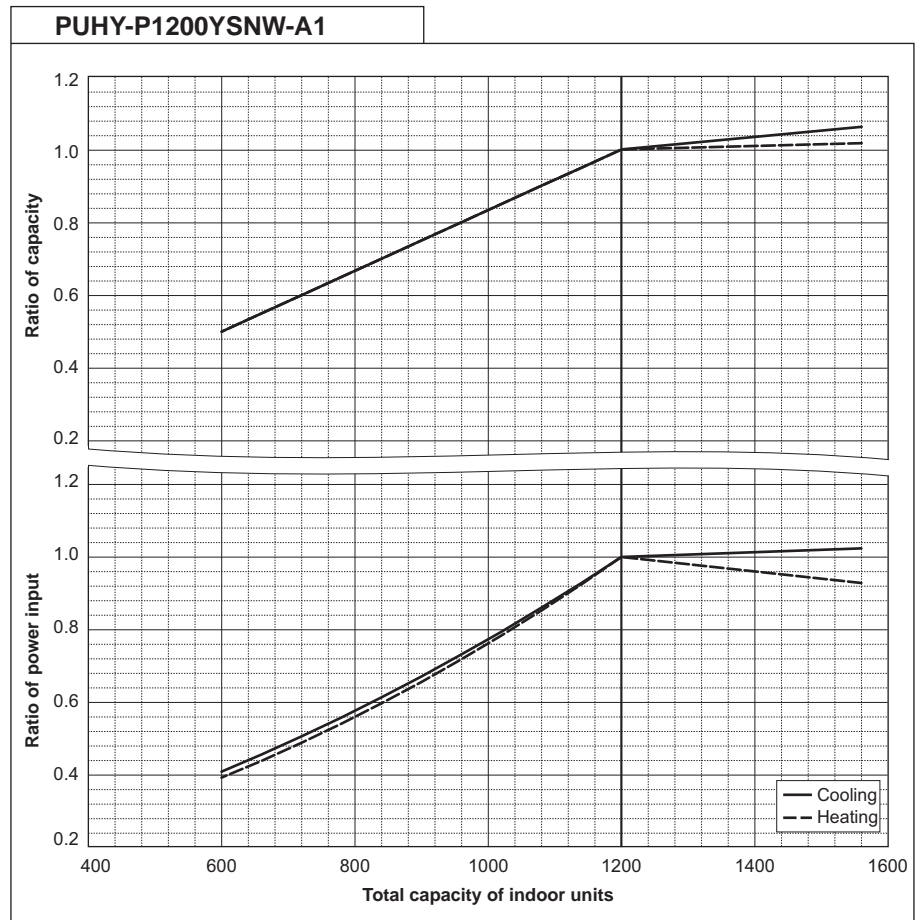

| PUHY-P1250YSNW-A1 | | |
|-------------------|-------|---------|
| Cooling Capacity | kW | 140.0 |
| | BTU/h | 477,700 |
| Input | kW | 44.30 |

| PUHY-P1250YSNW-A1 | | |
|-------------------|-------|---------|
| Heating Capacity | kW | 156.5 |
| | BTU/h | 534,000 |
| Input | kW | 40.12 |

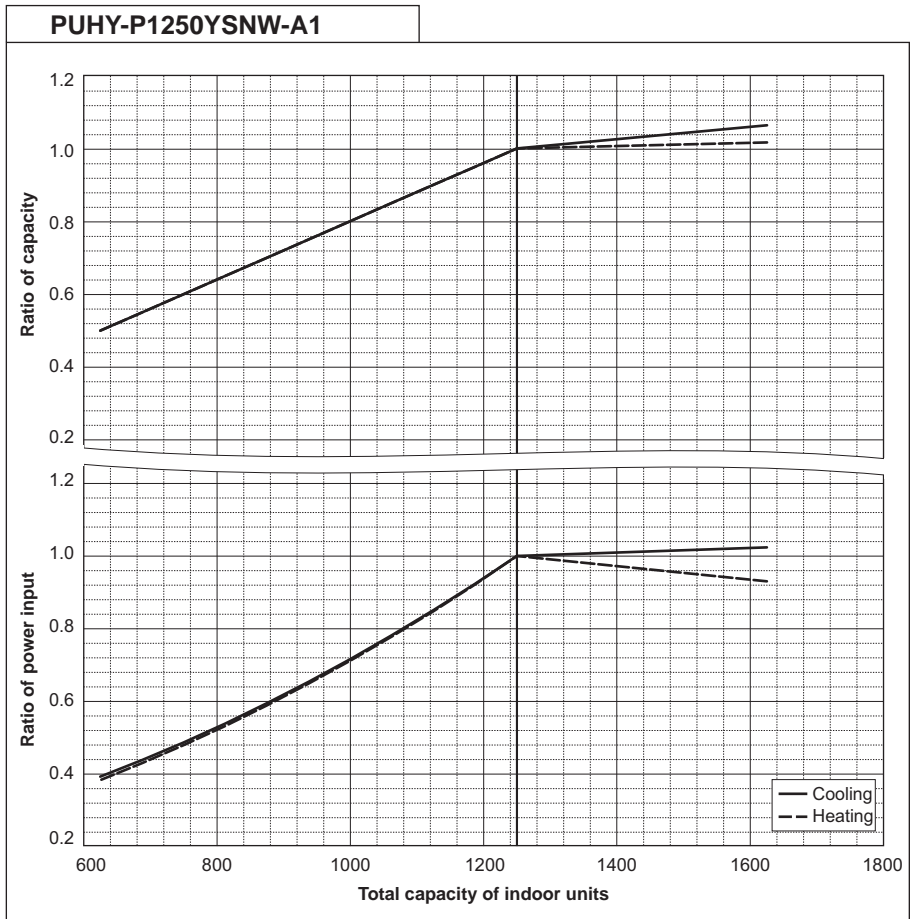

| PUHY-P1300YSNW-A1 | | |
|-------------------|-------|---------|
| Cooling Capacity | kW | 146.0 |
| | BTU/h | 498,200 |
| Input | kW | 45.06 |

| PUHY-P1300YSNW-A1 | | |
|-------------------|-------|---------|
| Heating Capacity | kW | 163.0 |
| | BTU/h | 556,200 |
| Input | kW | 41.90 |

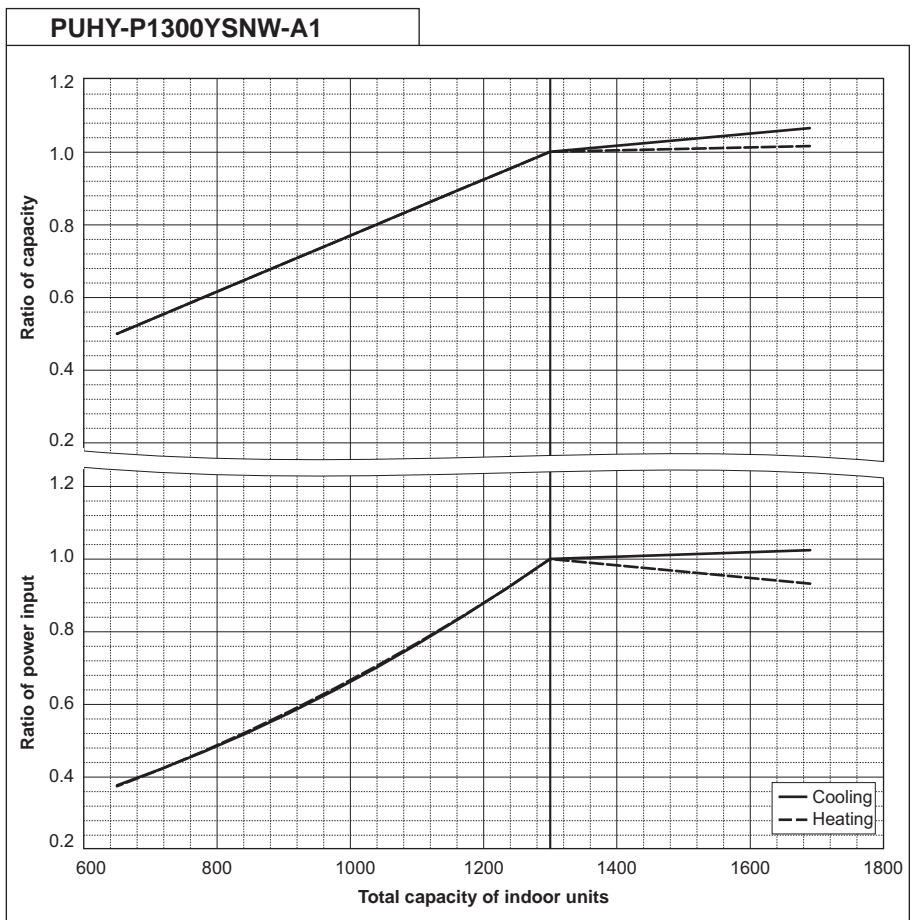

| PUHY-P1350YSNW-A1 | | |
|-------------------|-------|---------|
| Cooling Capacity | kW | 150.0 |
| | BTU/h | 511,800 |
| Input | kW | 45.18 |

| PUHY-P1350YSNW-A1 | | |
|-------------------|-------|---------|
| Heating Capacity | kW | 168.0 |
| | BTU/h | 573,200 |
| Input | kW | 43.29 |

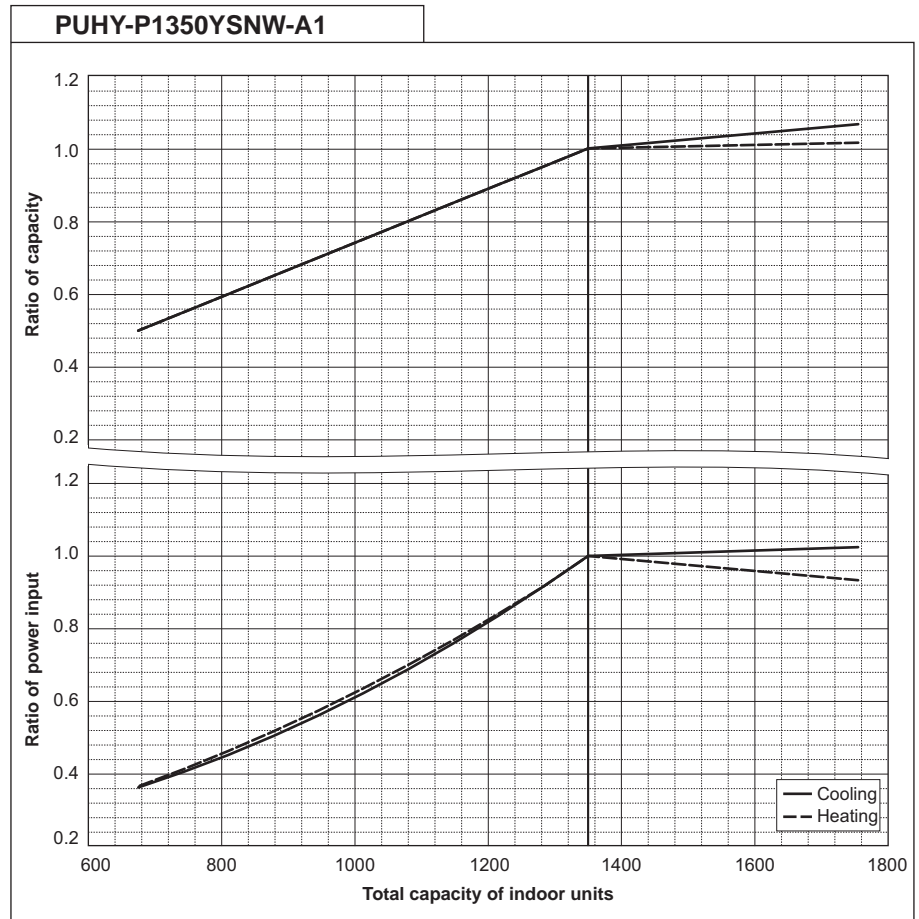

PUHY-P-Y(S)NW-A1

8-4. Correction by refrigerant piping length

CITY MULTI system can extend the piping flexibly within its limitation for the actual situation. However, a decrease of cooling/heating capacity could happen correspondently. Using following correction factor according to the equivalent length of the piping shown at 8-4-1 and 8-4-2, the capacity can be observed. 8-4-3 shows how to obtain the equivalent length of piping.

8-4-1. Cooling capacity correction

PUHY-P-Y(S)NW-A1

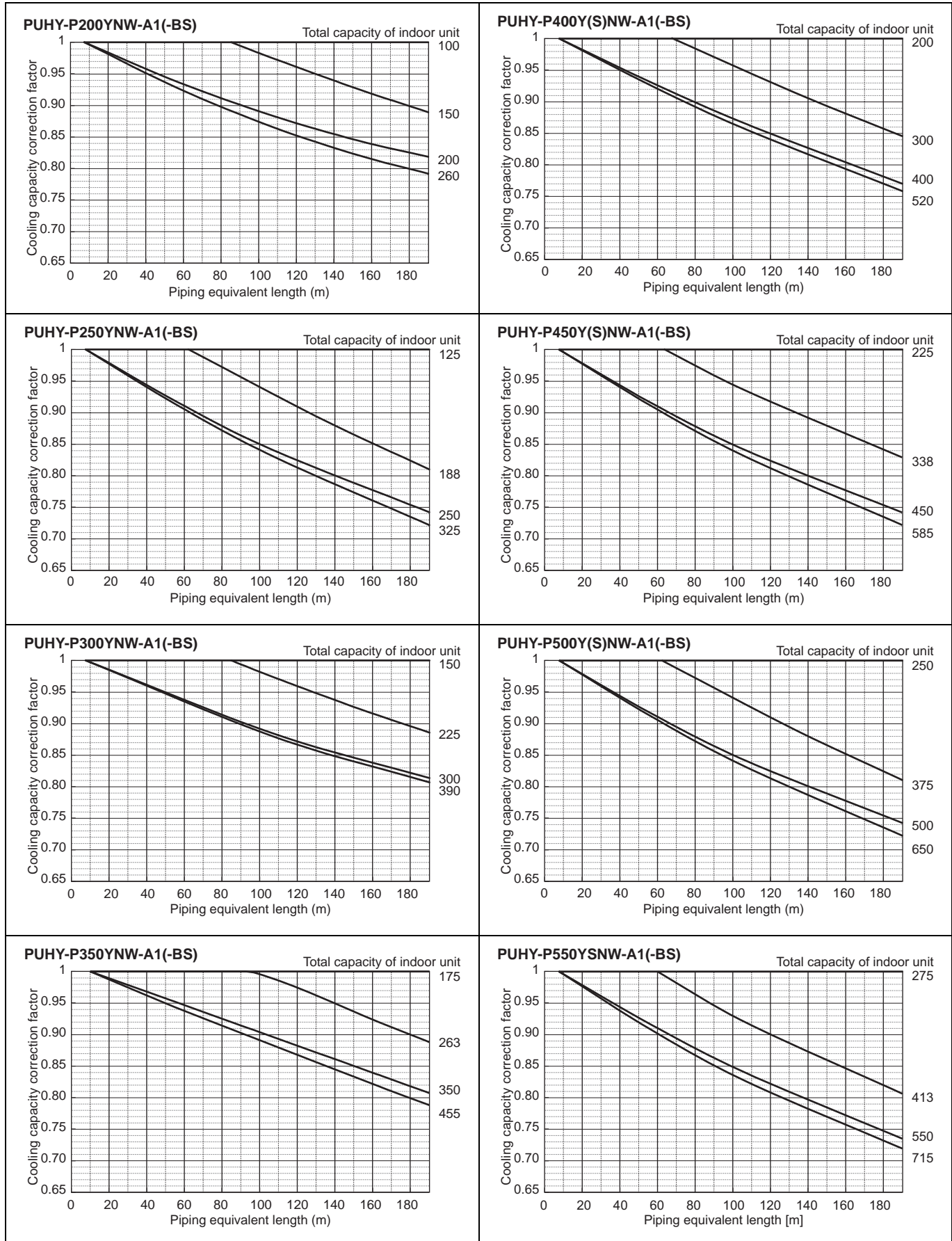

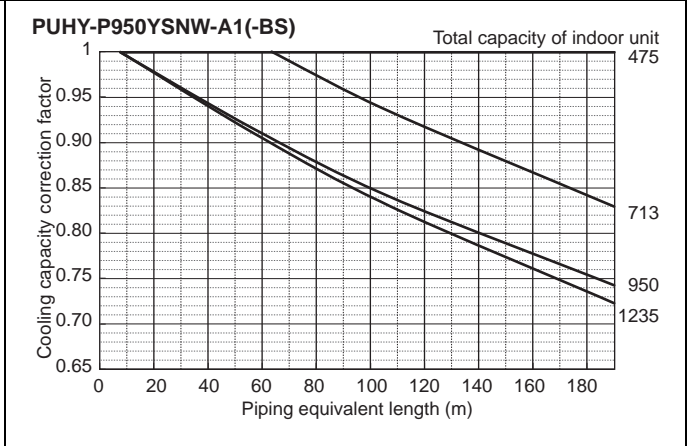
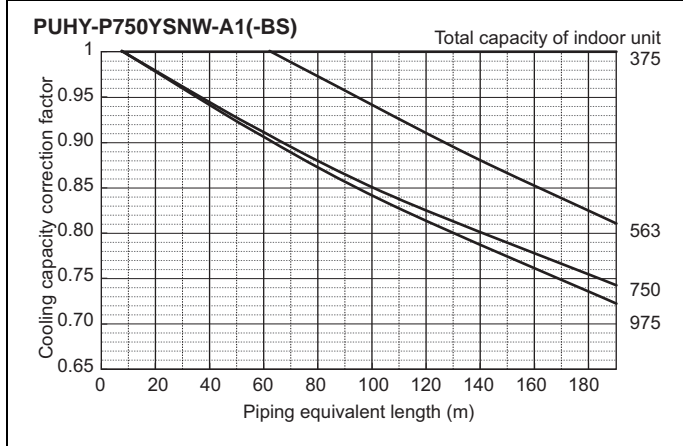
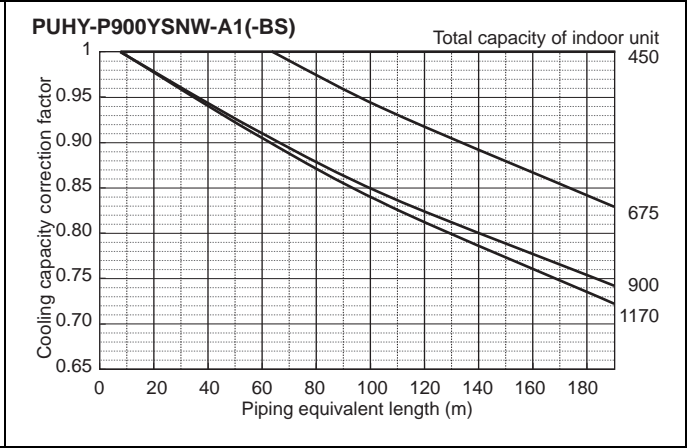
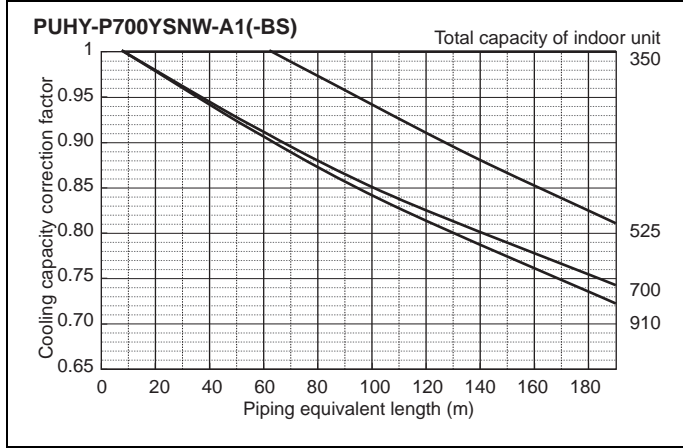
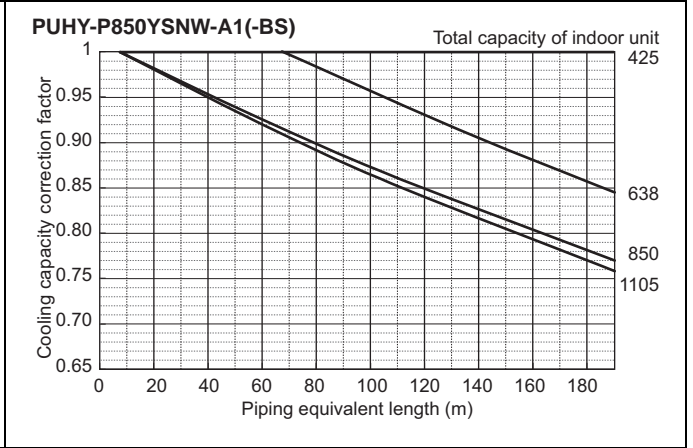
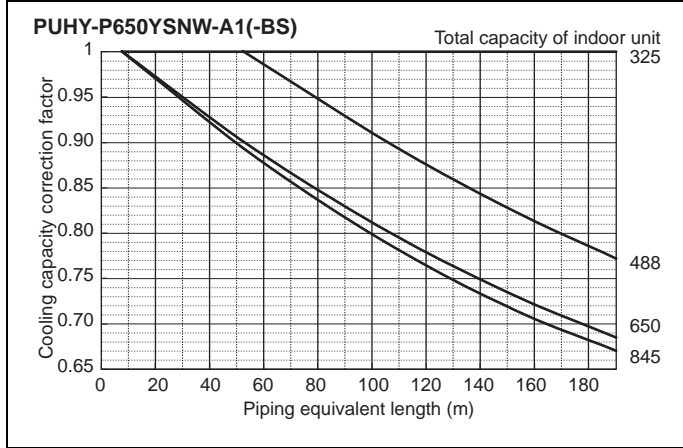
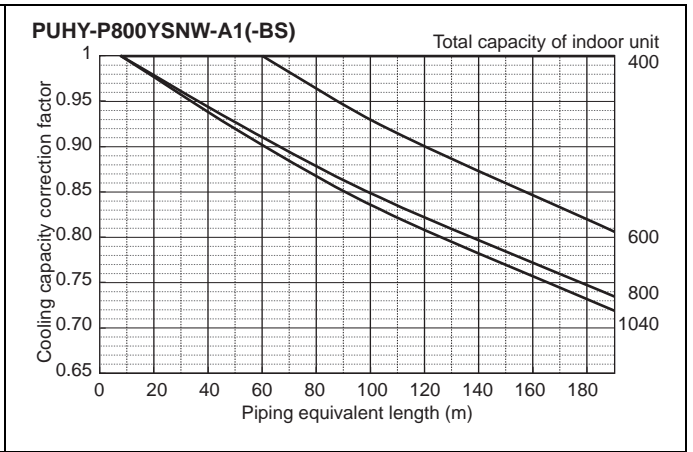
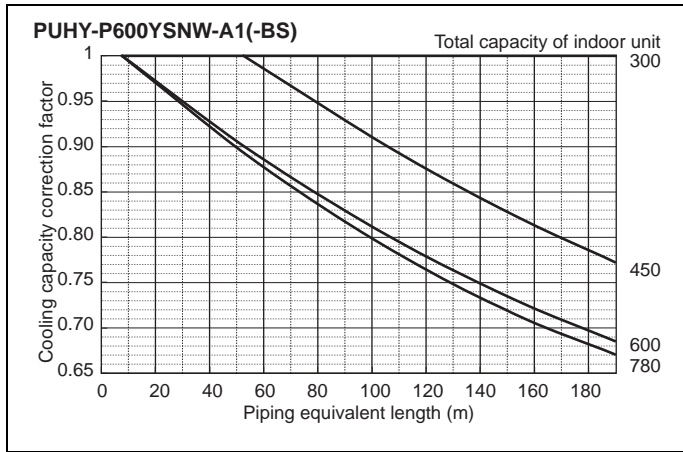

8. CAPACITY TABLES

PUHY-P-Y(S)NW-A1

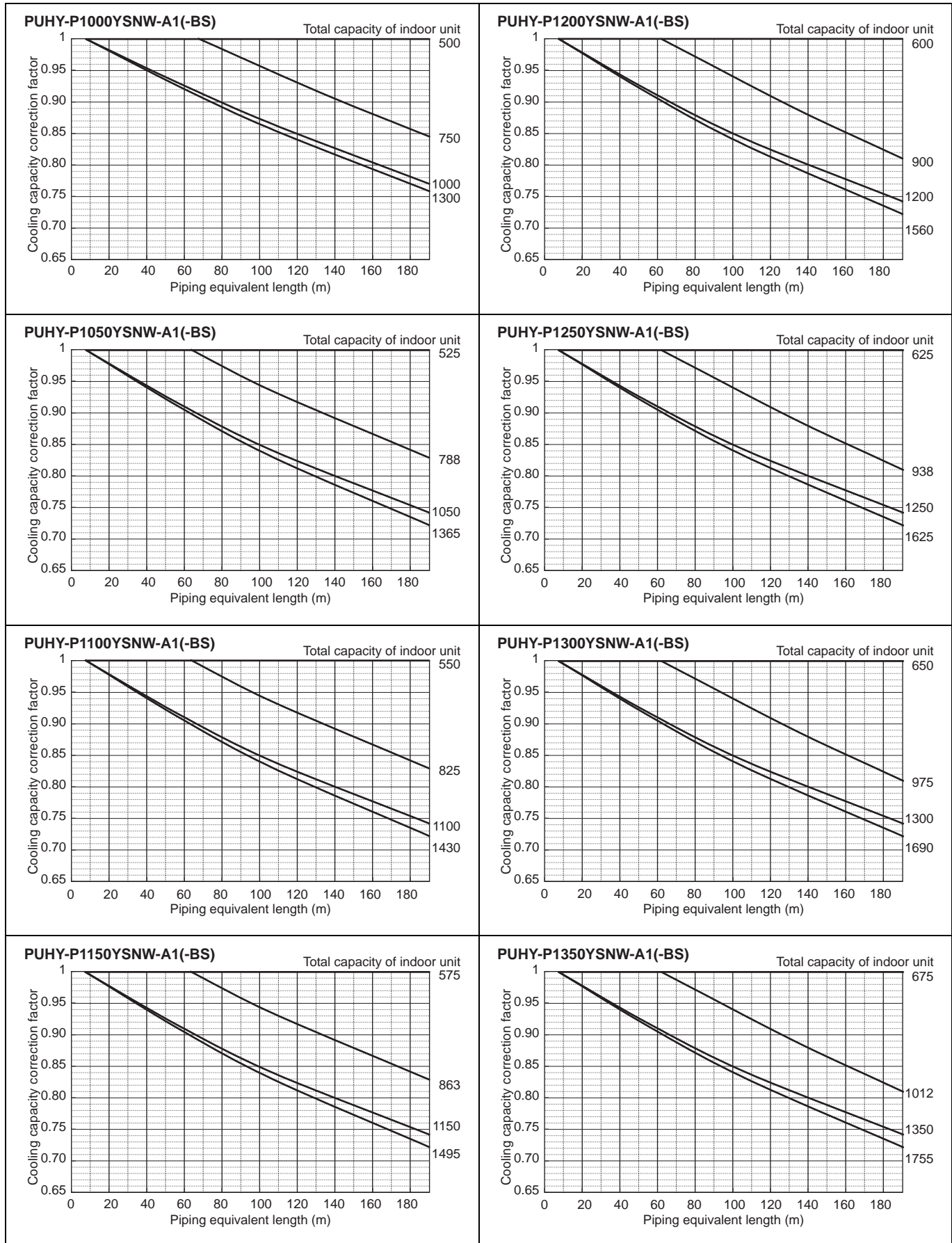

8-4-2. Heating capacity correction

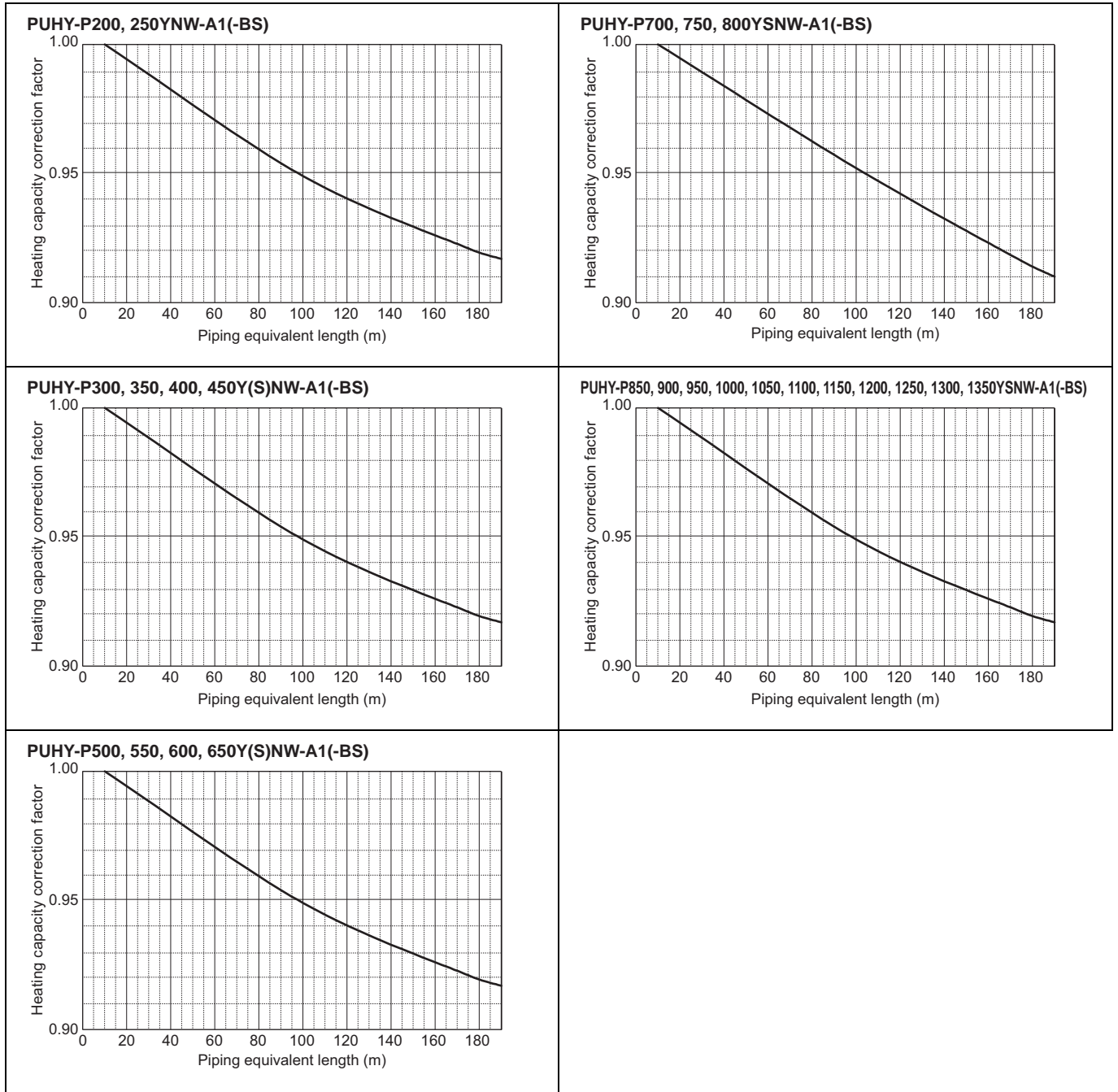

8-4-3. How to obtain the equivalent piping length

1. **PUHY-P200YNW-A1(-BS)**
Equivalent length = (Actual piping length to the farthest indoor unit) + (0.42 × number of bends in the piping) m
2. **PUHY-P250YNW-A1(-BS)**
Equivalent length = (Actual piping length to the farthest indoor unit) + (0.42 × number of bends in the piping) m
3. **PUHY-P300YNW-A1(-BS)**
Equivalent length = (Actual piping length to the farthest indoor unit) + (0.42 × number of bends in the piping) m
4. **PUHY-P350YNW-A1(-BS)**
Equivalent length = (Actual piping length to the farthest indoor unit) + (0.47 × number of bends in the piping) m
5. **PUHY-P400, 450, 500, 550, 600, 650Y(S)NW-A1(-BS)**
Equivalent length = (Actual piping length to the farthest indoor unit) + (0.50 × number of bends in the piping) m
6. **PUHY-P700, 750, 800YSNW-A1(-BS)**
Equivalent length = (Actual piping length to the farthest indoor unit) + (0.70 × number of bends in the piping) m
7. **PUHY-P850, 900, 950, 1000, 1050, 1100, 1150, 1200, 1250, 1300, 1350YNW-A1(-BS)**
Equivalent length = (Actual piping length to the farthest indoor unit) + (0.80 × number of bends in the piping) m

8-5. Correction at frost and defrost

Due to frost at the outdoor heat exchanger and the automatic defrost operation, the heating capacity of the outdoor unit can be calculated by multiplying the correction factor shown in the table below.

Table of correction factor at frost and defrost

| Outdoor inlet air temp. °CWB | 6 | 4 | 2 | 1 | 0 | -2 | -4 | -6 | -8 | -10 | -20 |
|------------------------------|------|------|------|------|------|------|------|------|------|------|------|
| Outdoor inlet air temp. °FWB | 43 | 39 | 36 | 34 | 32 | 28 | 25 | 21 | 18 | 14 | -4 |
| PUHY-P200YNW-A1(-BS) | 1.00 | 0.95 | 0.84 | 0.83 | 0.83 | 0.87 | 0.90 | 0.95 | 0.95 | 0.95 | 0.95 |
| PUHY-P250YNW-A1(-BS) | 1.00 | 0.95 | 0.84 | 0.83 | 0.83 | 0.87 | 0.90 | 0.95 | 0.95 | 0.95 | 0.95 |
| PUHY-P300YNW-A1(-BS) | 1.00 | 0.95 | 0.84 | 0.83 | 0.83 | 0.87 | 0.90 | 0.95 | 0.95 | 0.95 | 0.95 |
| PUHY-P350YNW-A1(-BS) | 1.00 | 0.95 | 0.84 | 0.83 | 0.83 | 0.87 | 0.90 | 0.95 | 0.95 | 0.95 | 0.95 |
| PUHY-P400YNW-A1(-BS) | 1.00 | 0.93 | 0.82 | 0.80 | 0.82 | 0.86 | 0.90 | 0.90 | 0.95 | 0.95 | 0.95 |
| PUHY-P450YNW-A1(-BS) | 1.00 | 0.93 | 0.82 | 0.80 | 0.82 | 0.86 | 0.90 | 0.90 | 0.95 | 0.95 | 0.95 |
| PUHY-P500YNW-A1(-BS) | 1.00 | 0.93 | 0.82 | 0.80 | 0.82 | 0.86 | 0.90 | 0.90 | 0.95 | 0.95 | 0.95 |
| PUHY-P400YSNW-A1(-BS) | 1.00 | 0.95 | 0.84 | 0.83 | 0.83 | 0.87 | 0.90 | 0.95 | 0.95 | 0.95 | 0.95 |
| PUHY-P450YSNW-A1(-BS) | 1.00 | 0.95 | 0.84 | 0.83 | 0.83 | 0.87 | 0.90 | 0.95 | 0.95 | 0.95 | 0.95 |
| PUHY-P500YSNW-A1(-BS) | 1.00 | 0.95 | 0.84 | 0.83 | 0.83 | 0.87 | 0.90 | 0.95 | 0.95 | 0.95 | 0.95 |
| PUHY-P550YSNW-A1(-BS) | 1.00 | 0.95 | 0.84 | 0.83 | 0.83 | 0.87 | 0.90 | 0.95 | 0.95 | 0.95 | 0.95 |
| PUHY-P600YSNW-A1(-BS) | 1.00 | 0.95 | 0.84 | 0.83 | 0.83 | 0.87 | 0.90 | 0.95 | 0.95 | 0.95 | 0.95 |
| PUHY-P650YSNW-A1(-BS) | 1.00 | 0.94 | 0.83 | 0.81 | 0.82 | 0.86 | 0.90 | 0.92 | 0.95 | 0.95 | 0.95 |
| PUHY-P700YSNW-A1(-BS) | 1.00 | 0.95 | 0.84 | 0.83 | 0.83 | 0.87 | 0.90 | 0.95 | 0.95 | 0.95 | 0.95 |
| PUHY-P750YSNW-A1(-BS) | 1.00 | 0.94 | 0.83 | 0.81 | 0.82 | 0.86 | 0.90 | 0.92 | 0.95 | 0.95 | 0.95 |
| PUHY-P800YSNW-A1(-BS) | 1.00 | 0.94 | 0.83 | 0.81 | 0.82 | 0.86 | 0.90 | 0.92 | 0.95 | 0.95 | 0.95 |
| PUHY-P850YSNW-A1(-BS) | 1.00 | 0.93 | 0.82 | 0.80 | 0.82 | 0.86 | 0.90 | 0.90 | 0.95 | 0.95 | 0.95 |
| PUHY-P900YSNW-A1(-BS) | 1.00 | 0.93 | 0.82 | 0.80 | 0.82 | 0.86 | 0.90 | 0.90 | 0.95 | 0.95 | 0.95 |
| PUHY-P950YSNW-A1(-BS) | 1.00 | 0.94 | 0.83 | 0.81 | 0.83 | 0.87 | 0.90 | 0.93 | 0.95 | 0.95 | 0.95 |
| PUHY-P1000YSNW-A1(-BS) | 1.00 | 0.94 | 0.83 | 0.82 | 0.83 | 0.87 | 0.90 | 0.93 | 0.95 | 0.95 | 0.95 |
| PUHY-P1050YSNW-A1(-BS) | 1.00 | 0.93 | 0.82 | 0.81 | 0.82 | 0.86 | 0.90 | 0.91 | 0.95 | 0.95 | 0.95 |
| PUHY-P1100YSNW-A1(-BS) | 1.00 | 0.94 | 0.83 | 0.82 | 0.83 | 0.87 | 0.90 | 0.93 | 0.95 | 0.95 | 0.95 |
| PUHY-P1150YSNW-A1(-BS) | 1.00 | 0.94 | 0.83 | 0.81 | 0.82 | 0.86 | 0.90 | 0.92 | 0.95 | 0.95 | 0.95 |
| PUHY-P1200YSNW-A1(-BS) | 1.00 | 0.93 | 0.82 | 0.80 | 0.82 | 0.86 | 0.90 | 0.90 | 0.95 | 0.95 | 0.95 |
| PUHY-P1250YSNW-A1(-BS) | 1.00 | 0.93 | 0.82 | 0.80 | 0.82 | 0.86 | 0.90 | 0.90 | 0.95 | 0.95 | 0.95 |
| PUHY-P1300YSNW-A1(-BS) | 1.00 | 0.93 | 0.82 | 0.80 | 0.82 | 0.86 | 0.90 | 0.90 | 0.95 | 0.95 | 0.95 |
| PUHY-P1350YSNW-A1(-BS) | 1.00 | 0.93 | 0.82 | 0.80 | 0.82 | 0.86 | 0.90 | 0.90 | 0.95 | 0.95 | 0.95 |

8-6. Correction at evaporation-temperature (ET) control

When the target evaporation temperature is changed, the capacity or the power input can be calculated by multiplying the correction factor shown in the table below.

| ET *1 | °C | 6 | 9 | 11 | 14 |
|-------------------|-------------|------|------|------|------|
| Correction factor | Capacity | 0.90 | 0.83 | 0.71 | 0.55 |
| | Power Input | 0.90 | 0.72 | 0.54 | 0.36 |

*1 The evaporation temperature in operation may be different from the preset target evaporation temperature because it depends on such factors as the unit protection control.

The capacity and power input could also fluctuate.

*2 Use the table above which indicates the unit properties as a reference

9-1. JOINT

CITY MULTI units can be easily connected by using Joint sets and Header sets provided by Mitsubishi Electric. Refer to section "Piping Design" or the Installation Manual that comes with the Joint set for how to install the Joint set.

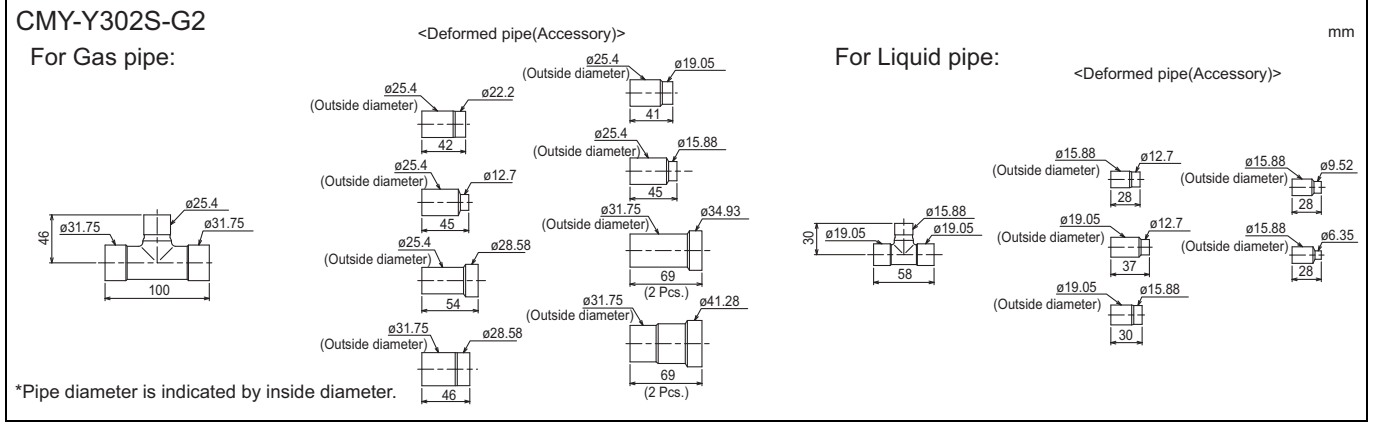
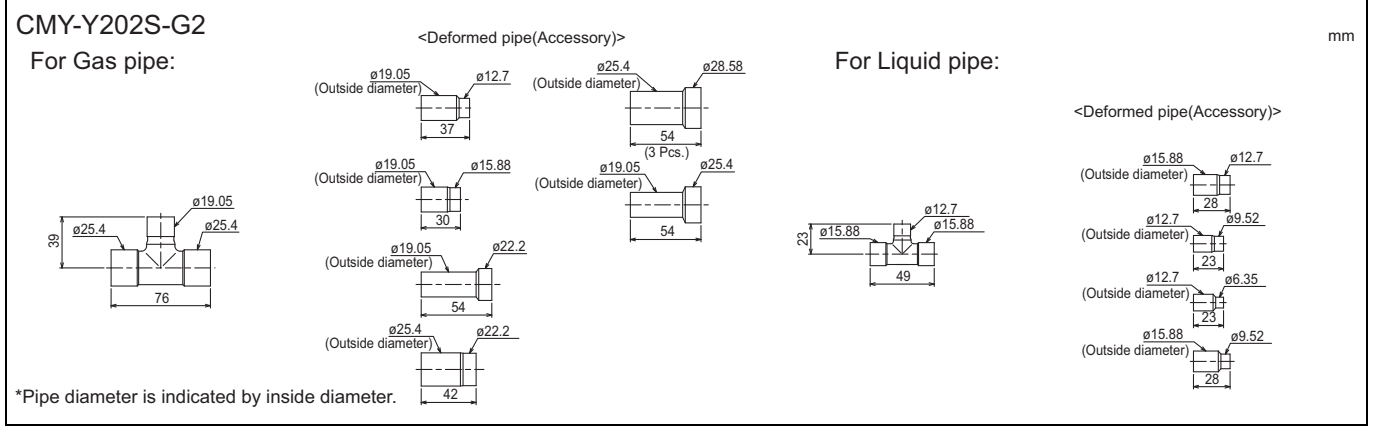
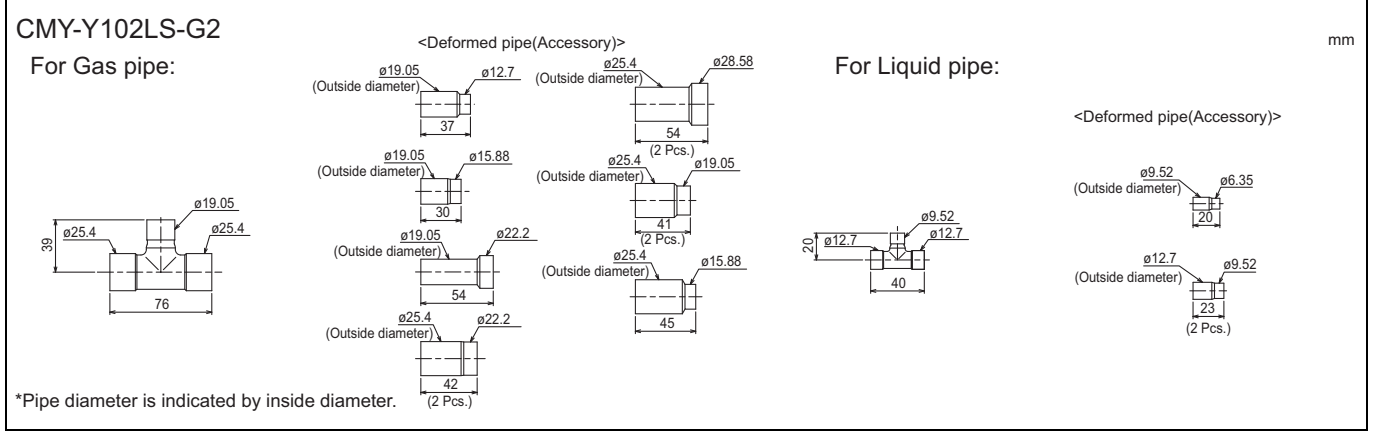
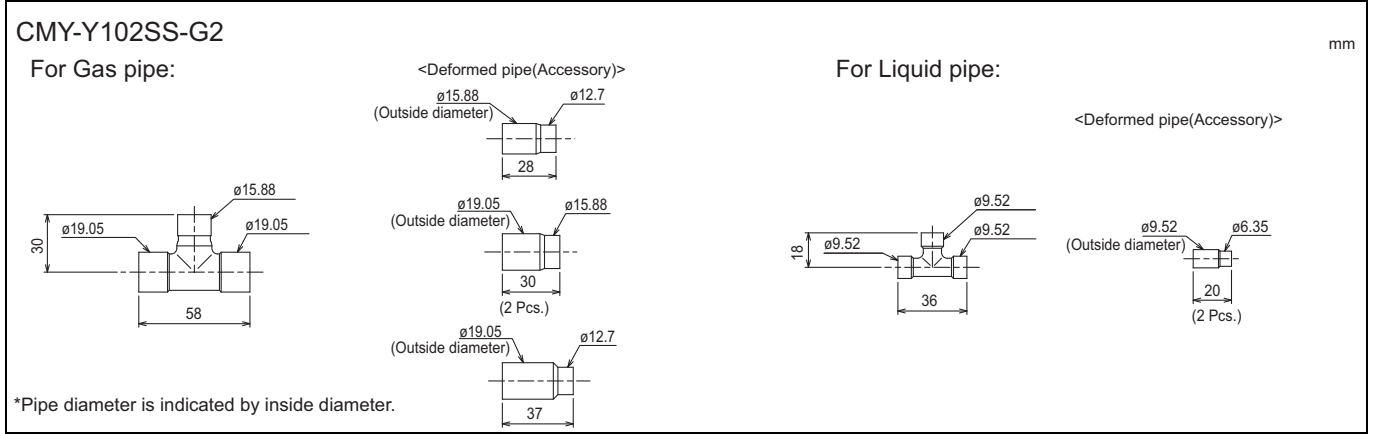

9-2. HEADER

CITY MULTI units can be easily connected by using Joint sets and Header sets provided by Mitsubishi Electric. Refer to section "Piping Design" or the Installation Manual that comes with the Header set for how to install the Header set.

PUHY-P-Y(S)NW-A1

CMY-Y104-G mm

For Gas pipe:

<Deformed pipe(Accessory)>

For Liquid pipe:

<Deformed pipe(Accessory)>

ID: Inner Diameter OD: Outer Diameter
NOTE: Besides above mentioned accessories, caps for pipe of φ 6.35, φ 9.52, φ 12.7, φ 15.88 (each diameter 1 piece) are included in the Header set.

CMY-Y108-G mm

For Gas pipe:

<Deformed pipe(Accessory)>

For Liquid pipe:

<Deformed pipe(Accessory)>

ID: Inner Diameter OD: Outer Diameter
NOTE: Besides above mentioned accessories, caps for pipe of φ 6.35, φ 9.52, φ 12.7, φ 15.88 (each diameter 2 pieces) and 1 cap for pipe of φ 19.05 are included in the Header set.

CMY-Y1010-G mm

For Gas pipe:

<Deformed pipe(Accessory)>

For Liquid pipe:

<Deformed pipe(Accessory)>

ID: Inner Diameter OD: Outer Diameter
NOTE: Besides above mentioned accessories, caps for pipe of φ 6.35, φ 9.52, φ 12.7, φ 15.88 (each diameter 2 pieces) and 1 cap for pipe of φ 19.05 are included in the Header set.

9-3. OUTDOOR TWINNING KIT

The following optional Outdoor Twinning Kit is needed to use to combine multiple refrigerant pipes. Refer to section "Piping Design" for the details of selecting a proper twinning kit.

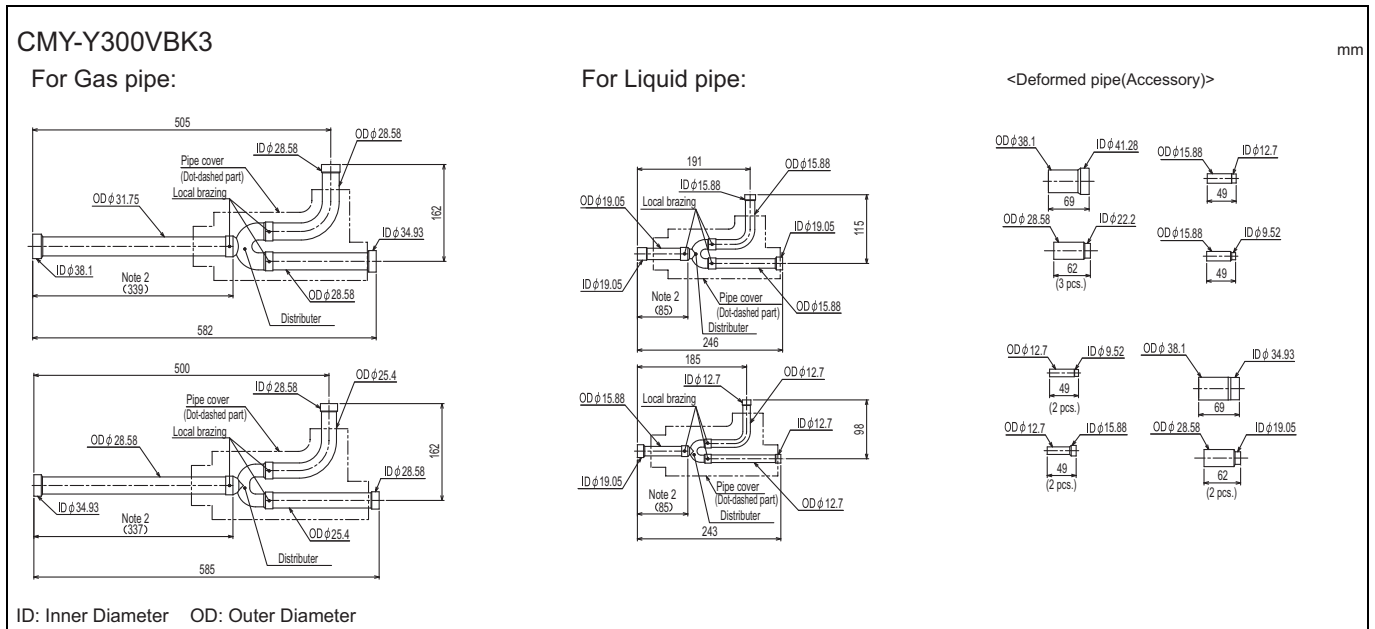
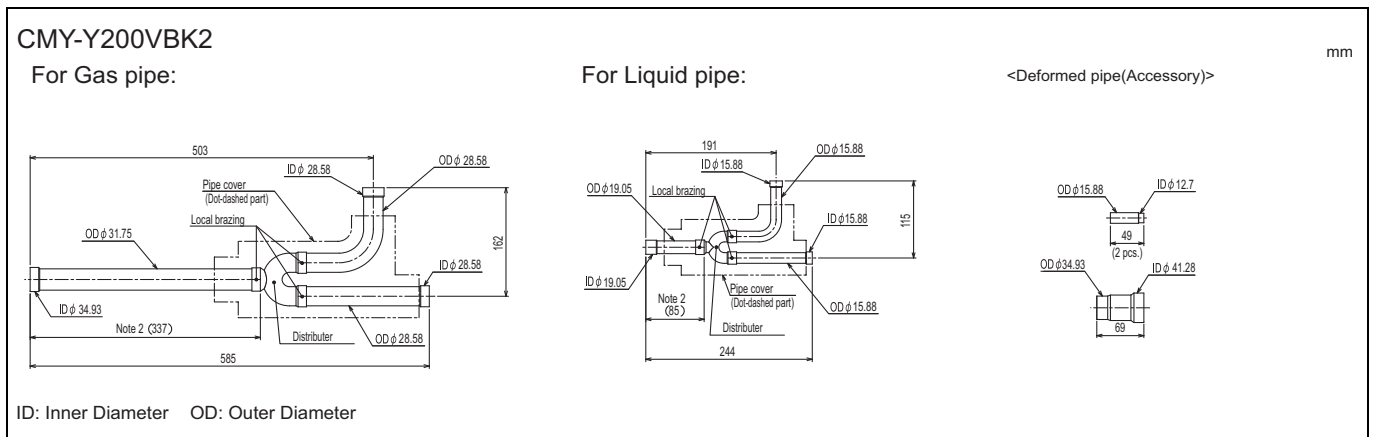
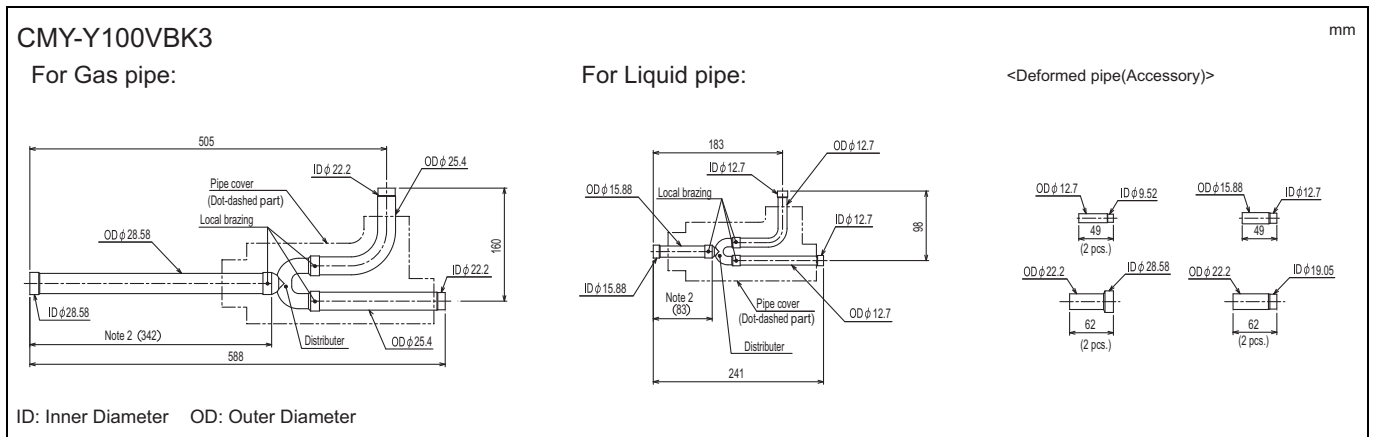

Note 1. Refer to the figure below for the installation position of the twinning pipe.

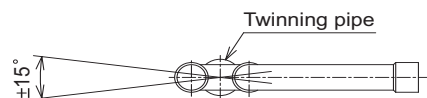

Slope of the twinning pipes are at an angle within $\pm 15^\circ$ to the horizontal plane.

2. Use the attached pipe to braze the port-opening of the twinning pipe.
3. Pipe diameter is indicated by inside diameter.
4. Only use the twinning pipe by Mitsubishi (optional parts).

PAC-FG02B-E

For rear surface of L module (a set of two pieces)

mm

■ Behind the unit (left)

■ Behind the unit (right)

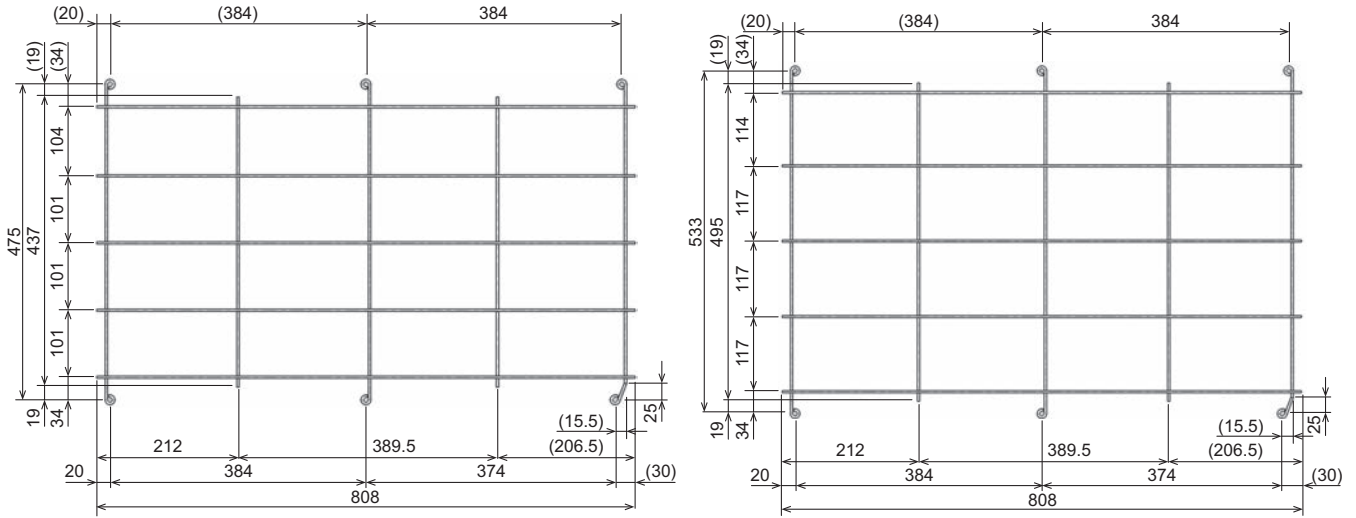

PAC-FG03B-E

For rear surface of XL module (a set of two pieces of the same type)

mm

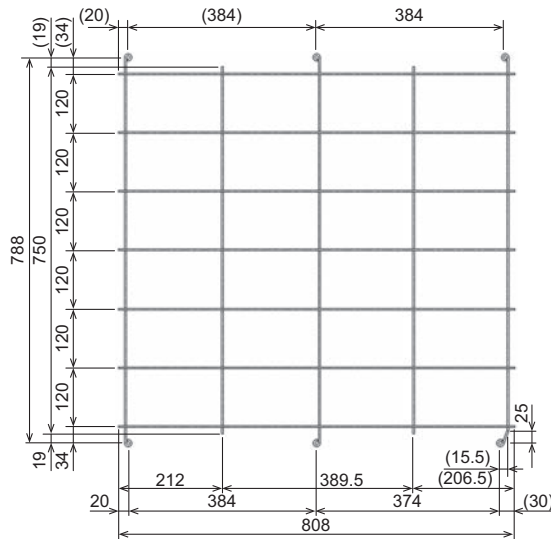

PUHY-P-Y(S)NW-A1

10-1. General cautions

- ① Follow ordinance of your governmental organization for technical standard related to electrical equipment, wiring regulations, and guidance of each electric power company.
- ② Wiring for control (hereinafter referred to as transmission cable) shall be (50mm[1-5/8in.] or more) apart from power source wiring so that it is not influenced by electric noise from power source wiring. (Do not insert transmission cable and power source wire in the same conduit.)
- ③ Be sure to provide designated grounding work to outdoor unit.
- ④ Give some allowance to wiring for electrical part box of indoor and outdoor units, because the box is sometimes removed at the time of service work.
- ⑤ Never connect 380~415V(220~240V) power source to terminal block of transmission cable. If connected, electrical parts will be damaged.
- ⑥ Use 2-core shield cable for transmission cable. If transmission cables of different systems are wired with the same multiple-core cable, the resultant poor transmitting and receiving will cause erroneous operations.
- ⑦ When extending the transmission line, make sure to extend the shield cable as well.

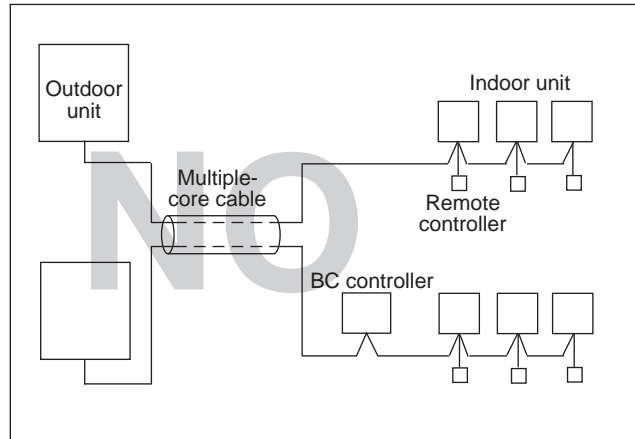
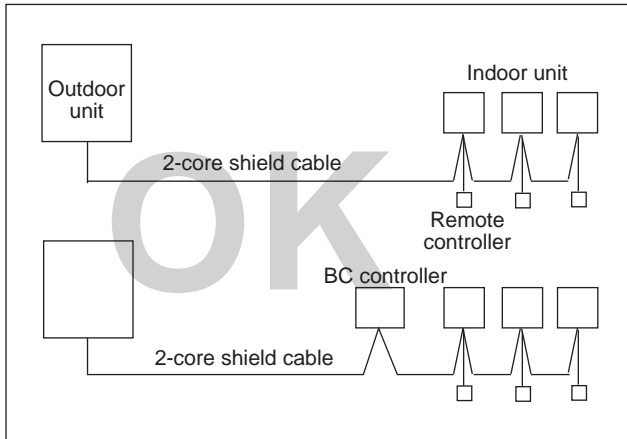

10-2. Power supply for Outdoor unit

10-2-1. Electrical characteristics of Outdoor unit

Symbols: MCA (Max Circuit Amps)

RLA (Rated Load Amps), SC (Starting Current)

| PUHY-P-YNW-A1 | Unit Combination | Units | | | Power supply | Compressor | | FAN | RLA(A)(50/60Hz) | |
|------------------------|----------------------|-------|-------------------|----------------------|--------------|----------------|----------------|-------------|-----------------|----------------|
| | | Hz | Volts | Voltage range | MCA(A) | Output (kW) | SC(A) | Output (kW) | Cooling | Heating |
| PUHY-P200YNW-A1(-BS) | - | 50/60 | 380 400 415 | Max:456V Min:342V | 16.1 | 3.5 | 8 | 0.92 | 8.1/7.7/7.4 | 8.6/8.1/7.8 |
| PUHY-P250YNW-A1(-BS) | - | | | | 17.8 | 5.3 | 8 | 0.92 | 12.0/11.4/11.0 | 12.1/11.5/11.1 |
| PUHY-P300YNW-A1(-BS) | - | | | | 22.7 | 6.7 | 8 | 0.92 | 14.8/14.0/13.5 | 14.2/13.5/13.0 |
| PUHY-P350YNW-A1(-BS) | - | | | | 26.4 | 8.6 | 8 | 0.46+0.46 | 18.4/17.5/16.9 | 17.5/16.6/16.0 |
| PUHY-P400YNW-A1(-BS) | - | | | | 31.9 | 11.4 | 8 | 0.46+0.46 | 23.9/22.7/21.9 | 20.8/19.8/19.1 |
| PUHY-P450YNW-A1(-BS) | - | | | | 37.1 | 11.7 | 8 | 0.46+0.46 | 24.5/23.3/22.5 | 23.6/22.4/21.6 |
| PUHY-P500YNW-A1(-BS) | - | | | | 43.7 | 13.3 | 8 | 0.92+0.92 | 29.6/28.1/27.1 | 26.9/25.6/24.7 |
| PUHY-P400YSNW-A1(-BS) | PUHY-P200YNW-A1(-BS) | | | | 16.1 | 3.5 | 8 | 0.92 | 16.8/15.9/15.4 | 17.7/16.8/16.2 |
| | PUHY-P200YNW-A1(-BS) | | | | 16.1 | 3.5 | 8 | 0.92 | | |
| PUHY-P450YSNW-A1(-BS) | PUHY-P200YNW-A1(-BS) | | | | 16.1 | 3.5 | 8 | 0.92 | 20.5/19.5/18.7 | 21.1/20.1/19.3 |
| | PUHY-P250YNW-A1(-BS) | | | | 17.8 | 5.3 | 8 | 0.92 | | |
| PUHY-P500YSNW-A1(-BS) | PUHY-P250YNW-A1(-BS) | | | | 17.8 | 5.3 | 8 | 0.92 | 24.8/23.6/22.7 | 25.1/23.8/23.0 |
| | PUHY-P250YNW-A1(-BS) | | | | 17.8 | 5.3 | 8 | 0.92 | | |
| PUHY-P550YSNW-A1(-BS) | PUHY-P250YNW-A1(-BS) | | | | 17.8 | 5.3 | 8 | 0.92 | 28.4/27.0/26.0 | 27.2/25.9/24.9 |
| | PUHY-P300YNW-A1(-BS) | | | | 22.7 | 6.7 | 8 | 0.92 | | |
| PUHY-P600YSNW-A1(-BS) | PUHY-P300YNW-A1(-BS) | | | | 22.7 | 6.7 | 8 | 0.92 | 31.5/29.9/28.8 | 30.0/28.5/27.5 |
| | PUHY-P300YNW-A1(-BS) | | | | 22.7 | 6.7 | 8 | 0.92 | | |
| PUHY-P650YSNW-A1(-BS) | PUHY-P250YNW-A1(-BS) | | | | 17.8 | 5.3 | 8 | 0.92 | 36.7/34.9/33.6 | 34.0/32.3/31.1 |
| | PUHY-P400YNW-A1(-BS) | | | | 31.9 | 11.4 | 8 | 0.46+0.46 | | |
| PUHY-P700YSNW-A1(-BS) | PUHY-P350YNW-A1(-BS) | | | | 26.4 | 8.6 | 8 | 0.46+0.46 | 38.1/36.2/34.9 | 35.3/33.5/32.3 |
| | PUHY-P350YNW-A1(-BS) | | | | 26.4 | 8.6 | 8 | 0.46+0.46 | | |
| PUHY-P750YSNW-A1(-BS) | PUHY-P350YNW-A1(-BS) | | | | 26.4 | 8.6 | 8 | 0.46+0.46 | 43.6/41.4/39.9 | 39.5/37.6/36.2 |
| | PUHY-P400YNW-A1(-BS) | | | | 31.9 | 11.4 | 8 | 0.46+0.46 | | |
| PUHY-P800YSNW-A1(-BS) | PUHY-P350YNW-A1(-BS) | | | | 26.4 | 8.6 | 8 | 0.46+0.46 | 44.4/42.1/40.6 | 41.9/39.8/38.4 |
| | PUHY-P450YNW-A1(-BS) | | | | 37.1 | 11.7 | 8 | 0.46+0.46 | | |
| PUHY-P850YSNW-A1(-BS) | PUHY-P400YNW-A1(-BS) | | | | 31.9 | 11.4 | 8 | 0.46+0.46 | 50.6/48.1/46.3 | 46.8/44.5/42.9 |
| | PUHY-P450YNW-A1(-BS) | | | | 37.1 | 11.7 | 8 | 0.46+0.46 | | |
| PUHY-P900YSNW-A1(-BS) | PUHY-P450YNW-A1(-BS) | | | | 37.1 | 11.7 | 8 | 0.46+0.46 | 51.3/48.7/47.0 | 49.1/46.7/45.0 |
| | PUHY-P450YNW-A1(-BS) | | | | 37.1 | 11.7 | 8 | 0.46+0.46 | | |
| PUHY-P950YSNW-A1(-BS) | PUHY-P250YNW-A1(-BS) | | | | 17.8 | 5.3 | 8 | 0.92 | 50.6/48.1/46.3 | 47.9/45.5/43.8 |
| | PUHY-P350YNW-A1(-BS) | | | | 26.4 | 8.6 | 8 | 0.46+0.46 | | |
| PUHY-P1000YSNW-A1(-BS) | PUHY-P350YNW-A1(-BS) | | | | 26.4 | 8.6 | 8 | 0.46+0.46 | 55.9/53.1/51.2 | 52.4/49.7/47.9 |
| | PUHY-P250YNW-A1(-BS) | | | | 17.8 | 5.3 | 8 | 0.92 | | |
| PUHY-P1050YSNW-A1(-BS) | PUHY-P400YNW-A1(-BS) | | | | 31.9 | 11.4 | 8 | 0.46+0.46 | 61.4/58.3/56.2 | 55.8/53.0/51.1 |
| | PUHY-P400YNW-A1(-BS) | | | | 31.9 | 11.4 | 8 | 0.46+0.46 | | |
| PUHY-P1100YSNW-A1(-BS) | PUHY-P350YNW-A1(-BS) | | | | 26.4 | 8.6 | 8 | 0.46+0.46 | 62.1/59.0/56.8 | 57.7/54.8/52.8 |
| | PUHY-P400YNW-A1(-BS) | | | | 31.9 | 11.4 | 8 | 0.46+0.46 | | |
| PUHY-P1150YSNW-A1(-BS) | PUHY-P350YNW-A1(-BS) | | | | 26.4 | 8.6 | 8 | 0.46+0.46 | 68.3/64.9/62.5 | 61.1/58.1/56.0 |
| | PUHY-P400YNW-A1(-BS) | | | | 31.9 | 11.4 | 8 | 0.46+0.46 | | |
| PUHY-P1200YSNW-A1(-BS) | PUHY-P400YNW-A1(-BS) | | | | 31.9 | 11.4 | 8 | 0.46+0.46 | 74.7/71.0/68.4 | 64.7/61.5/59.2 |
| | PUHY-P400YNW-A1(-BS) | | | | 31.9 | 11.4 | 8 | 0.46+0.46 | | |
| PUHY-P1250YSNW-A1(-BS) | PUHY-P400YNW-A1(-BS) | | | | 31.9 | 11.4 | 8 | 0.46+0.46 | 74.7/71.0/68.4 | 67.7/64.3/62.0 |
| | PUHY-P450YNW-A1(-BS) | 37.1 | 11.7 | 8 | 0.46+0.46 | | | | | |
| PUHY-P1300YSNW-A1(-BS) | PUHY-P400YNW-A1(-BS) | 31.9 | 11.4 | 8 | 0.46+0.46 | 76.0/72.2/69.6 | 70.7/67.1/64.7 | | | |
| | PUHY-P450YNW-A1(-BS) | 37.1 | 11.7 | 8 | 0.46+0.46 | | | | | |
| PUHY-P1350YSNW-A1(-BS) | PUHY-P450YNW-A1(-BS) | 37.1 | 11.7 | 8 | 0.46+0.46 | 76.2/72.4/69.8 | 73.0/69.4/66.9 | | | |
| | PUHY-P450YNW-A1(-BS) | 37.1 | 11.7 | 8 | 0.46+0.46 | | | | | |

PUHY-P-Y(S)NW-A1

10-3. Power cable specifications

Thickness of wire for main power supply, capacities of the switch and system impedance

| | Model | Minimum wire thickness (mm ²) | | | Ground-fault interrupter *1 | Local switch (A) | | Breaker for wiring (A) (Non-fuse breaker) | Max.Permissible System Impedance |
|--------------|-----------------|-------------------------------------------|--------|--------|-----------------------------|------------------|------|----------------------------------------------|-------------------------------------|
| | | Main cable | Branch | Ground | | Capacity | Fuse | | |
| Outdoor unit | PUHY-P200YNW-A1 | 4.0 | - | 4.0 | 30A 100mA 0.1sec. or less | 25 | 25 | 30 | *2 |
| | PUHY-P250YNW-A1 | 4.0 | - | 4.0 | 30A 100mA 0.1sec. or less | 32 | 32 | 30 | *2 |
| | PUHY-P300YNW-A1 | 4.0 | - | 4.0 | 30A 100mA 0.1sec. or less | 32 | 32 | 30 | *2 |
| | PUHY-P350YNW-A1 | 6.0 | - | 6.0 | 40A 100mA 0.1sec. or less | 40 | 40 | 40 | 0.27Ω |
| | PUHY-P400YNW-A1 | 10.0 | - | 10.0 | 60A 100mA 0.1sec. or less | 63 | 63 | 60 | 0.22Ω |
| | PUHY-P450YNW-A1 | 10.0 | - | 10.0 | 60A 100mA 0.1sec. or less | 63 | 63 | 60 | 0.19Ω |
| | PUHY-P500YNW-A1 | 10.0 | - | 10.0 | 60A 100mA 0.1sec. or less | 63 | 63 | 60 | 0.16Ω |

*1 The Ground-fault interrupter should support Inverter circuit.

The Ground-fault interrupter should combine using of local switch or wiring breaker.

*2 Meet technical requirements of IEC61000-3-3

1. Use dedicated power supplies for the outdoor unit and indoor unit. Ensure OC and OS are wired individually.
2. Bear in mind ambient conditions (ambient temperature, direct sunlight, rain water, etc.) when proceeding with the wiring and connections.
3. The wire size is the minimum value for metal conduit wiring. If the voltage drops, use a wire that is one rank thicker in diameter. Make sure the power-supply voltage does not drop more than 10%. Make sure that the voltage imbalance between the phases is 2% or less.
4. Specific wiring requirements should adhere to the wiring regulations of the region.
5. Power supply cords of parts of appliances for outdoor use shall not be lighter than polychloroprene sheathed flexible cord (design 60245 IEC57). For example, use wiring such as YZW.
6. A switch with at least 3 mm contact separation in each pole shall be provided by the Air conditioner installation.
7. For details on indoor unit wiring and breaker for current leakage, refer to the indoor unit Instruction Book and Installation Manual.

⚠ WARNING

- ◆ Be sure to use specified wires for connections and ensure no external force is imparted to terminal connections. If connections are not fixed firmly, heating or fire may result.
- ◆ Be sure to use the appropriate type of overcurrent protection switch. Note that generated overcurrent may include some amount of direct current.

⚠ CAUTION

- ◆ The breakers for current leakage should support Inverter circuit. (e.g. Mitsubishi Electric's NV-S-Series or equivalent). If no earth leakage breaker is installed, it may cause an electric shock.
- ◆ Breakers for current leakage should combine using of switch.
- ◆ Do not use anything other than a breaker with the correct capacity. Using a breaker of too large capacity may cause malfunction or fire.
- ◆ If a large electric current flows due to malfunction or faulty wiring, earth-leakage breakers on the unit side and on the upstream side of the power supply system may both operate. Depending on the importance of the system, separate the power supply system or take protective coordination of breakers.

Note

- ◆ This device is intended for the connection to a power supply system with a maximum permissible system impedance shown in the above table at the interface point (power service box) of the user's supply.
- ◆ The user must ensure that this device is connected only to a power supply system which fulfils the requirement above. If necessary, the user can ask the public power supply company for the system impedance at the interface point.
- ◆ This equipment complies with IEC 61000-3-12 provided that the short-circuit power Ssc is greater than or equal to Ssc (*2) at the interface point between the user's supply and the public system. It is the responsibility of the installer or user of the equipment to ensure, by consultation with the distribution network operator if necessary, that the equipment is connected only to a supply with a short-circuit power Ssc greater than or equal to Ssc (*2).

Ssc(*2)

| Model | PUHY-P200YNW-A1 | PUHY-P250YNW-A1 | PUHY-P300YNW-A1 | PUHY-P350YNW-A1 | PUHY-P400YNW-A1 | PUHY-P450YNW-A1 | PUHY-P500YNW-A1 |
|-----------|-----------------|-----------------|-----------------|-----------------|-----------------|-----------------|-----------------|
| Ssc (MVA) | 1.25 | 1.38 | 1.76 | 2.05 | 2.48 | 2.88 | 3.39 |

10-4. Power supply examples

The local standards and/or regulations is applicable at a higher priority.

10-4-1. PUHY-P200, 250, 300, 350, 400, 450, 500YNW-A1

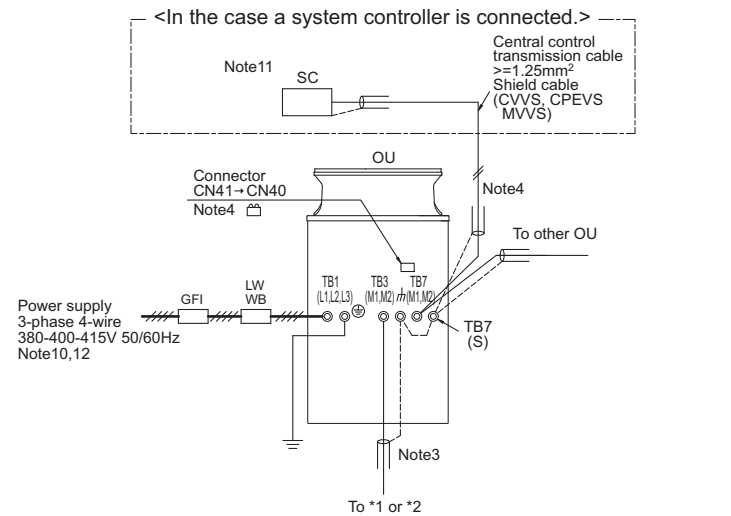

Note:

- The transmission cable is non-polarity double-wire.
- Symbol Ⓞ means a screw terminal for wiring.
- The shield wire of transmission cable should be connected to the grounding terminal at Outdoor unit. All shield wire of M-Net transmission cable among Indoor units should be connected to the S terminal at Indoor unit or all shield wire should be connected together. The broken line at the scheme means shield wire.
- When the Outdoor unit connected with system controller, power-supply to TB7 of the outdoor unit(s) is needed. The connector change from CN41 to CN40 at one of the outdoor units will enable the outdoor unit to supply power to TB7, or an extra power supplying unit PAC-SC51KUA should be used. The transmission cable (above 1.25mm², shielded, CVVS/CPEVS/MVVS) among Outdoor units and system controllers is called central control transmission cable. The shield wire of the central control transmission cable must be grounded at the Outdoor unit whose CN41 is changed to CN40. When the power supplying unit PAC-SC51KUA is used, connect the shielded cable to the ground terminal on the PAC-SC51KUA.
- MA R/C transmission cable (0.3-1.25mm²) must be less than 200m in length, while ME R/C transmission cable (0.3-1.25mm²) must be less than 10m in length. But transmission cable to the ME R/C can be extend using a M-NET cable (>=1.25mm²) when the length is counted in the M-Net length.
- MA remote controller and ME remote controller should not be grouped together. When a PAR-CT01MA, PAR-4XMAA, or PAR-3XMAA ("X" represents 0 or later) is connected to a group, no other MA remote controllers can be connected to the same group.
- If using 1 or 2 (main/sub) MA remote controller to control more than 1 Indoor unit, use MA transmission cable to connect all the TB15 terminals of the Indoor units. It is called "Grouping". If using 1 or 2 (main/sub) ME remote controller control more than 1 indoor unit, set address to Indoor unit and ME remote controller. For the method, refer to 11-4. "Address setting".
- Indoor board consumes power from TB3. The power balance should be considered according to System Design 11-3. "System configuration restrictions".
- If Transmission booster is needed, be sure to connect the shield wires to the both sides to the booster.
- The critical current for choosing power source equipment is approximate 1.4 times of total rated current of the Outdoor unit(s) or Indoor unit(s).
- When System controller (SC) is connected to the system, turn the SW5-1 on.
- The phases of electricity power must be confirmed to be right used. Phase-reverse, or phase-missing could break the controllers.

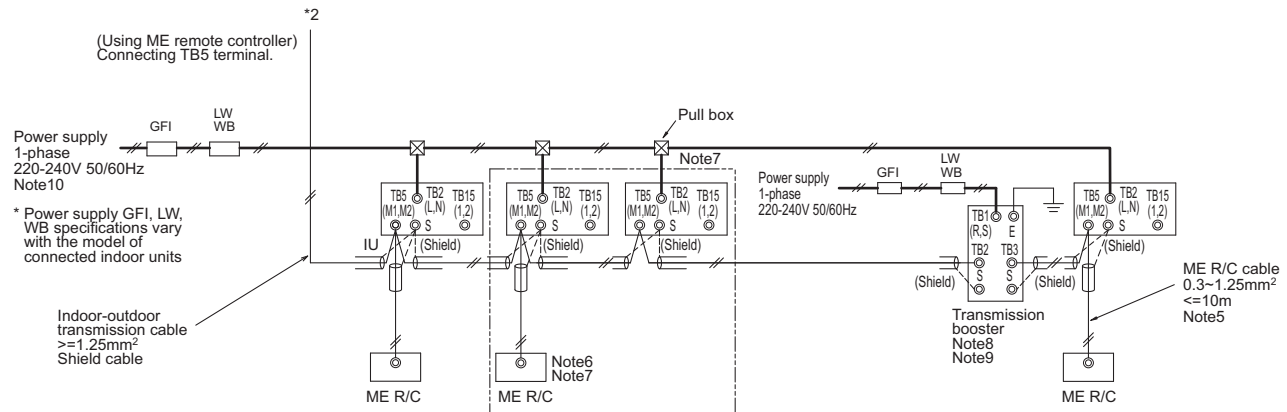
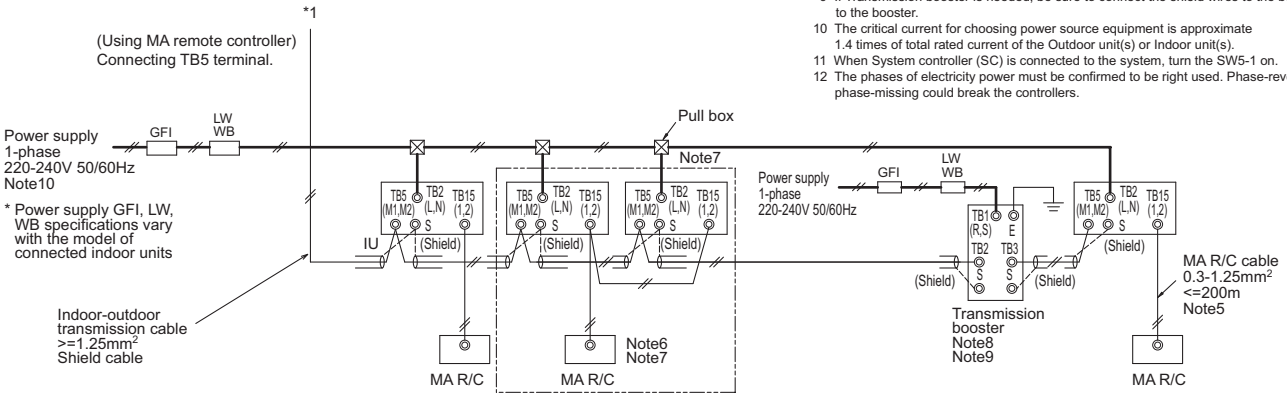

| Symbol | Model | Ground-fault interrupter *1, *2, *4 | Local switch | | Wiring breaker*4 (NFB) <A> | Minimum Wire thickness | | |
|--------|--------------------------|----------------------------------------|---------------------------|------------------|----------------------------------|------------------------|---------------------|----|
| | | | BKC <A> | OCP*3, *4 <A> | | Power wire <mm²> | Earth wire <mm²> | |
| GFI | Ground-fault interrupter | PUHY-P200YNW-A1 | 30A 100mA 0.1sec. or less | 25 | 25 | 30 | 4 | 4 |
| LW | Local switch | PUHY-P250YNW-A1 | 30A 100mA 0.1sec. or less | 32 | 32 | 30 | 4 | 4 |
| BKC | Breaker capacity | PUHY-P300YNW-A1 | 30A 100mA 0.1sec. or less | 32 | 32 | 30 | 4 | 4 |
| OCP | Over-current protector | PUHY-P350YNW-A1 | 40A 100mA 0.1sec. or less | 40 | 40 | 40 | 6 | 6 |
| WB | Wiring breaker | PUHY-P400YNW-A1 | 60A 100mA 0.1sec. or less | 63 | 63 | 60 | 10 | 10 |
| NFB | Non-fuse breaker | PUHY-P450YNW-A1 | 60A 100mA 0.1sec. or less | 63 | 63 | 60 | 10 | 10 |
| OU | Outdoor unit | PUHY-P500YNW-A1 | 60A 100mA 0.1sec. or less | 63 | 63 | 60 | 10 | 10 |

*1 The Ground-fault interrupter should support Inverter circuit. (e.g. Mitsubishi Electric's NV-S-Series or equivalent).

*2 Ground-fault interrupter should combine using of local switch or wiring breaker.

*3 It shows data for B-type fuse of the breaker for current leakage.

*4 If a large electric current flows due to malfunction or faulty wiring, earth-leakage breakers on the unit side and on the centralized controller side may both operate.

Depending on the importance of the system, separate the power supply system or take protective coordination of breakers.

The local standards and/or regulations is applicable at a higher priority.
 10-4-2. PUHY-P400, 450, 500, 550, 600, 650, 700, 750, 800, 850, 900YSNW-A1

PUHY-P-Y(S)NW-A1

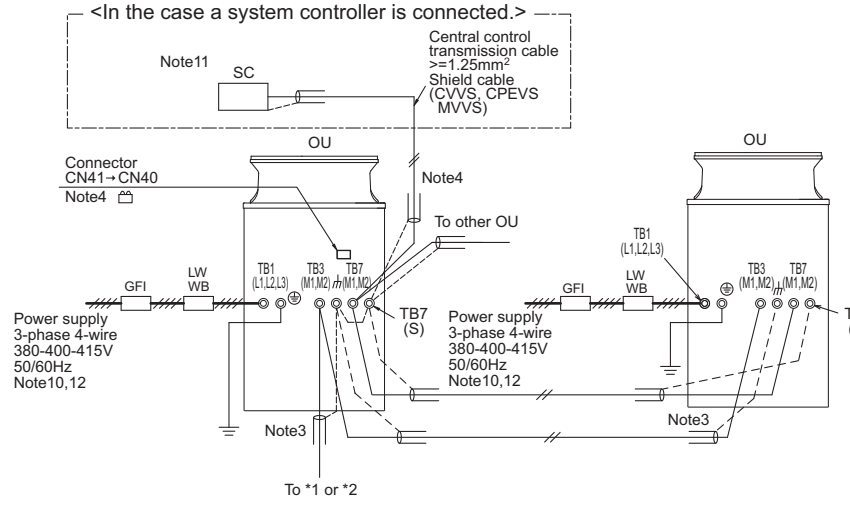

- Note:
- The transmission cable is not-polarity double-wire.
 - Symbol \odot means a screw terminal for wiring.
 - The shield wire of transmission cable should be connected to the grounding terminal at Outdoor unit. All shield wire of M-Net transmission cable among Indoor units should be connected to the S terminal at Indoor unit or all shield wire should be connected together. The broken line at the scheme means shield wire.
 - When the Outdoor unit connected with system controller, power-supply to TB7 of the outdoor unit(s) is needed. The connector change from CN41 to CN40 at one of the outdoor units will enable the outdoor unit to supply power to TB7, or an extra power supplying unit PAC-SC51KUA should be used. The transmission cable (above 1.25mm², shielded, CVVS/CPEVS/MVVS) among Outdoor units and system controllers is called central control transmission cable. The shield wire of the central control transmission cable must be grounded at the Outdoor unit whose CN41 is changed to CN40. When the power supplying unit PAC-SC51KUA is used, connect the shielded cable to the ground terminal on the PAC-SC51KUA.
 - MA R/C transmission cable (0.3-1.25mm²) must be less than 200m in length, while ME R/C transmission cable (0.3-1.25mm²) must be less than 10m in length. But transmission cable to the ME R/C can be extended using a M-NET cable ($\geq 1.25\text{mm}^2$) when the length is counted in the M-Net length.
 - MA remote controller and ME remote controller should not be grouped together. When a PAR-CT01MA, PAR-4XMAA, or PAR-3XMAA ("X" represents 0 or later) is connected to a group, no other MA remote controllers can be connected to the same group.
 - If using 1 or 2 (main/sub) MA remote controller to control more than 1 Indoor unit, use MA transmission cable to connect all the TB15 terminals of the Indoor units. It is called "Grouping". If using 1 or 2 (main/sub) ME remote controller control more than 1 indoor unit, set address to Indoor unit and ME remote controller. For the method, refer to 11-4. "Address setting".
 - Indoor board consumes power from TB3. The power balance should be considered according to System Design 11-3. "System configuration restrictions".
 - If Transmission booster is needed, be sure to connect the shield wires to the both sides to the booster.
 - The critical current for choosing power source equipment is approximate 1.4 times of total rated current of the Outdoor unit(s) or Indoor unit(s).
 - When System controller (SC) is connected to the system, turn the SW5-1 on.
 - The phases of electricity power must be confirmed to be right used. Phase-reverse, or phase-missing could break the controllers.

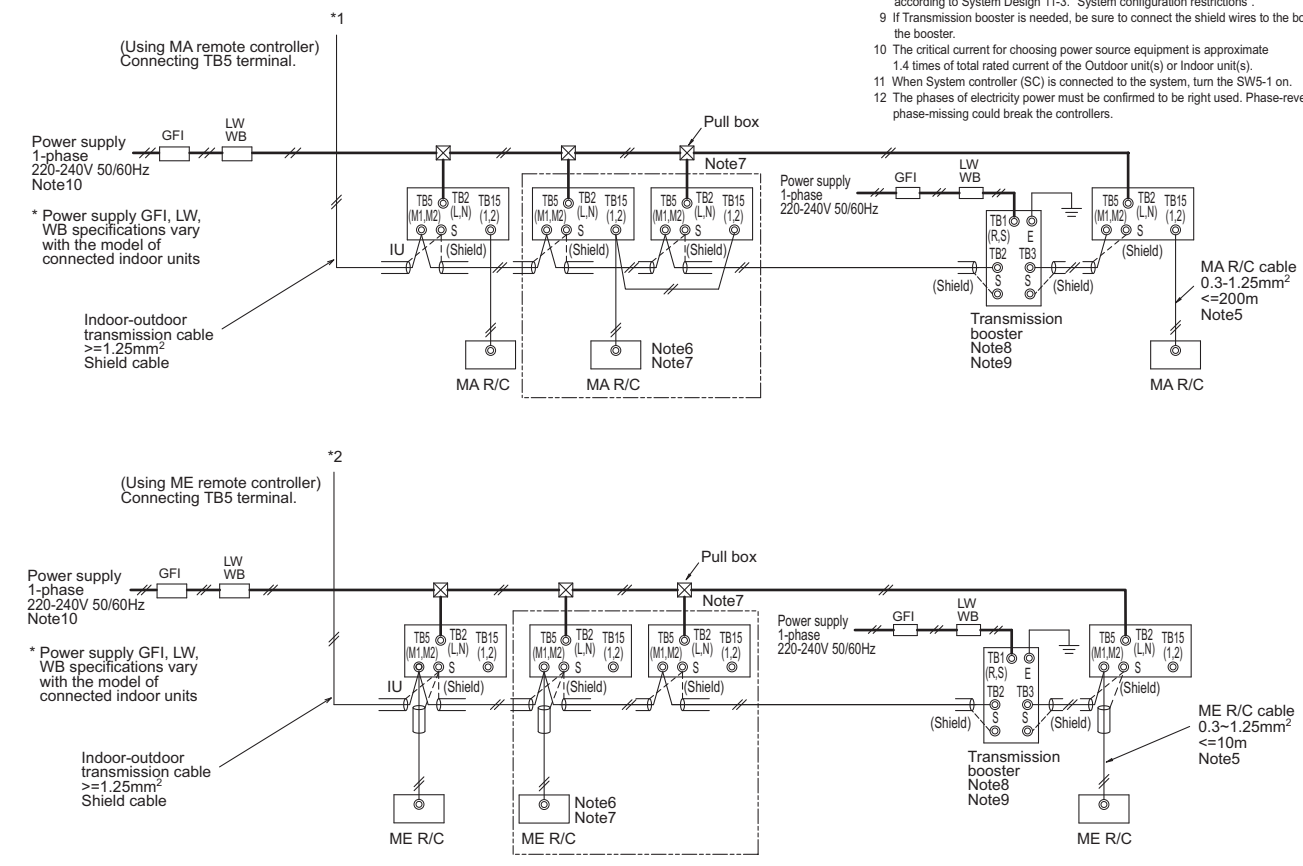

| Symbol | Model | Ground-fault interrupter *1, *2, *4 | Local switch | | | Wiring breaker*4 | | Minimum Wire thickness | |
|--------|--------------------------|----------------------------------------|---------------------------|------------------|--------------|----------------------------------|----------------------------------|------------------------|--|
| | | | BKC <A> | OCP*3, *4 <A> | (NFB) <A> | Power wire <mm ² > | Earth wire <mm ² > | | |
| GFI | Ground-fault interrupter | PUHY-P200YNW-A1 | 30A 100mA 0.1sec. or less | 25 | 25 | 30 | 4 | 4 | |
| LW | Local switch | PUHY-P250YNW-A1 | 30A 100mA 0.1sec. or less | 32 | 32 | 30 | 4 | 4 | |
| BKC | Breaker capacity | PUHY-P300YNW-A1 | 30A 100mA 0.1sec. or less | 32 | 32 | 30 | 4 | 4 | |
| OCP | Over-current protector | PUHY-P350YNW-A1 | 40A 100mA 0.1sec. or less | 40 | 40 | 40 | 6 | 6 | |
| WB | Wiring breaker | PUHY-P400YNW-A1 | 60A 100mA 0.1sec. or less | 63 | 63 | 60 | 10 | 10 | |
| NFB | Non-fuse breaker | PUHY-P450YNW-A1 | 60A 100mA 0.1sec. or less | 63 | 63 | 60 | 10 | 10 | |

*1 The Ground-fault interrupter should support Inverter circuit. (e.g. Mitsubishi Electric's NV-S-Series or equivalent).

*2 Ground-fault interrupter should combine using of local switch or wiring breaker.

*3 It shows data for B-type fuse of the breaker for current leakage.

*4 If a large electric current flows due to malfunction or faulty wiring, earth-leakage breakers on the unit side and on the centralized controller side may both operate.
Depending on the importance of the system, separate the power supply system or take protective coordination of breakers.

The local standards and/or regulations is applicable at a higher priority.

10-4-3. PUHY-P950, 1000, 1050, 1100, 1150, 1200, 1250, 1300, 1350YSNW-A1

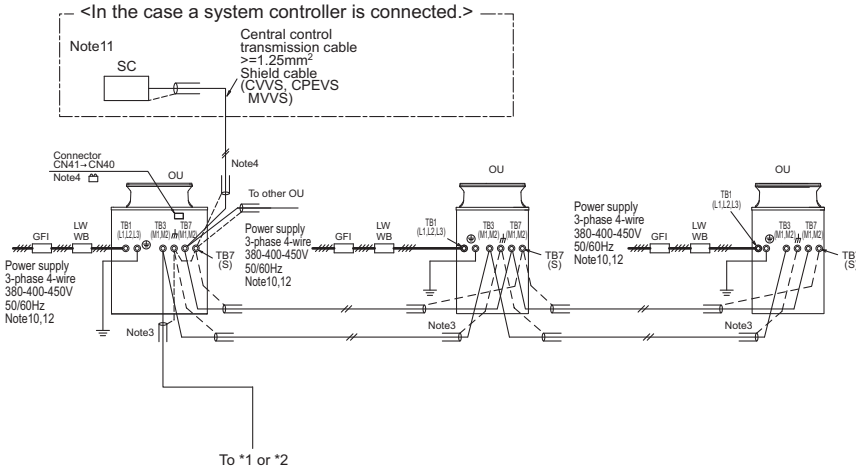

- Note:
- The transmission cable is not-polarity double-wire.
 - Symbol \odot means a screw terminal for wiring.
 - The shield wire of transmission cable should be connected to the grounding terminal at Outdoor unit. All shield wire of M-Net transmission cable among Indoor units should be connected to the S terminal at Indoor unit or all shield wire should be connected together. The broken line at the scheme means shield wire.
 - When the Outdoor unit connected with system controller, power-supply to TB7 of the outdoor unit(s) is needed. The connector change from CN41 to CN40 at one of the outdoor units will enable the outdoor unit to supply power to TB7, or an extra power supplying unit PAC-SC51KUA should be used. The transmission cable (above 1.25mm^2 , shielded, CVVS/CPEVS/MVVS) among Outdoor units and system controllers is called central control transmission cable. The shield wire of the central control transmission cable must be grounded at the Outdoor unit whose CN41 is changed to CN40. When the power supplying unit PAC-SC51KUA is used, connect the shielded cable to the ground terminal on the PAC-SC51KUA.
 - MA R/C transmission cable ($0.3\sim 1.25\text{mm}^2$) must be less than 200m in length, while ME R/C transmission cable ($0.3\sim 1.25\text{mm}^2$) must be less than 10m in length. But transmission cable to the ME R/C can be extend using a M-NET cable ($>1.25\text{mm}^2$) when the length is counted in the M-Net length.
 - MA remote controller and ME remote controller should not be grouped together. When a PAR-CT01MA, PAR-4XMAA, or PAR-3XMAA ("X" represents 0 or later) is connected to a group, no other MA remote controllers can be connected to the same group.
 - If using 1 or 2 (main/sub) MA remote controller to control more than 1 Indoor unit, use MA transmission cable to connect all the TB15 terminals of the Indoor units. It is called "Grouping". If using 1 or 2 (main/sub) ME remote controller control more than 1 indoor unit, set address to Indoor unit and ME remote controller. For the method, refer to 11-4. "Address setting".
 - Indoor board consumes power from TB3. The power balance should be considered according to System Design 11-3. "System configuration restrictions".
 - If Transmission booster is needed, be sure to connect the shield wires to the both sides to the booster.
 - The critical current for choosing power source equipment is approximate 1.4 times of total rated current of the Outdoor unit(s) or Indoor unit(s).
 - When System controller (SC) is connected to the system, turn the SW5-1 on.
 - The phases of electricity power must be confirmed to be right used. Phase-reverse, or phase-missing could break the controllers.

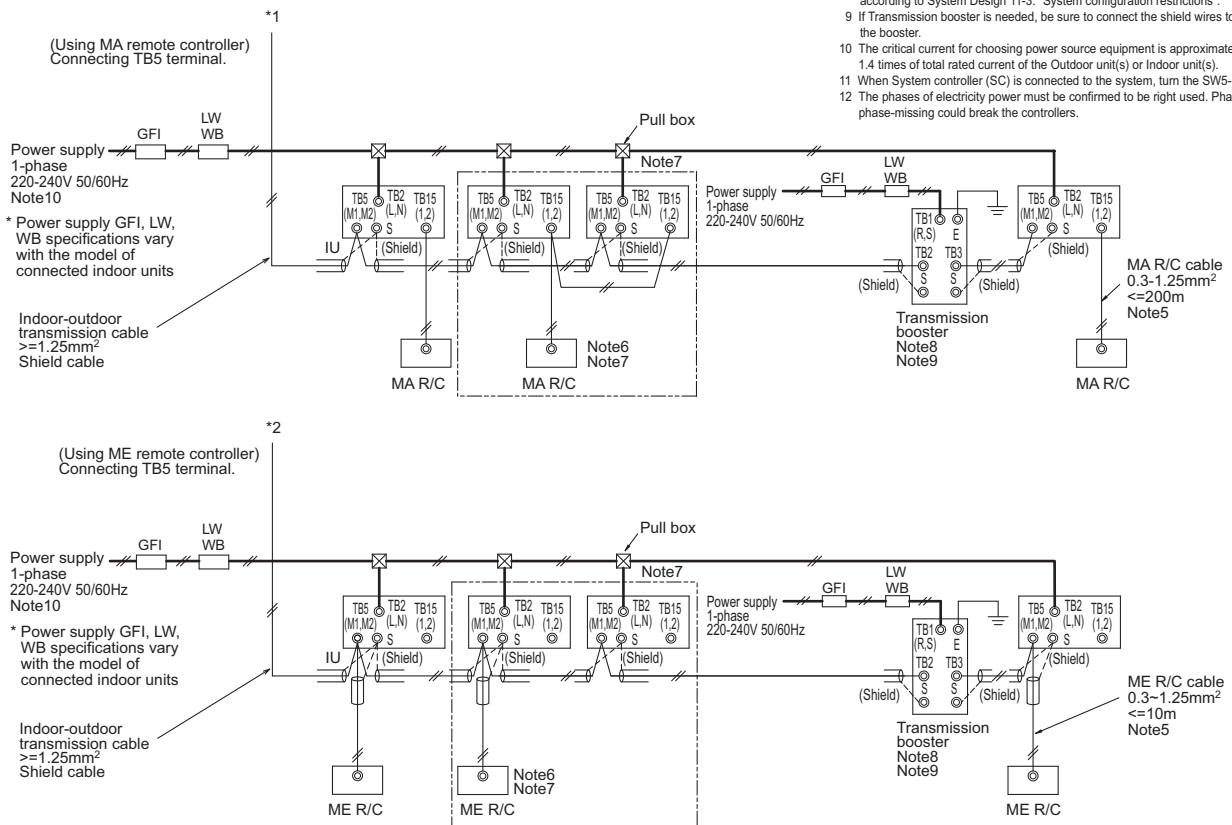

| Symbol | Model | Ground-fault interrupter *1, *2, *4 | Local switch | | | Minimum Wire thickness | | |
|--------|--------------------------|----------------------------------------|---------------------------|------------------|----------------------------------|----------------------------------|----------------------------------|----|
| | | | BKC <A> | OCP*3, *4 <A> | Wiring breaker*4 (NFB) <A> | Power wire <mm ² > | Earth wire <mm ² > | |
| GFI | Ground-fault interrupter | PUHY-P200YNW-A1 | 30A 100mA 0.1sec. or less | 25 | 25 | 30 | 4 | 4 |
| LW | Local switch | PUHY-P250YNW-A1 | 30A 100mA 0.1sec. or less | 32 | 32 | 30 | 4 | 4 |
| BKC | Breaker capacity | PUHY-P300YNW-A1 | 30A 100mA 0.1sec. or less | 32 | 32 | 30 | 4 | 4 |
| OCP | Over-current protector | PUHY-P350YNW-A1 | 40A 100mA 0.1sec. or less | 40 | 40 | 40 | 6 | 6 |
| WB | Wiring breaker | PUHY-P400YNW-A1 | 60A 100mA 0.1sec. or less | 63 | 63 | 60 | 10 | 10 |
| NFB | Non-fuse breaker | PUHY-P450YNW-A1 | 60A 100mA 0.1sec. or less | 63 | 63 | 60 | 10 | 10 |

*1 The Ground-fault interrupter should support Inverter circuit. (e.g. Mitsubishi Electric's NV-S-Series or equivalent).

*2 Ground-fault interrupter should combine using of local switch or wiring breaker.

*3 It shows data for B-type fuse of the breaker for current leakage.

*4 If a large electric current flows due to malfunction or faulty wiring, earth-leakage breakers on the unit side and on the centralized controller side may both operate.
Depending on the importance of the system, separate the power supply system or take protective coordination of breakers.

PUHY-P-Y(S)NW-A1

11-1. Transmission cable length limitation

11-1-1. Using MA Remote controller

Long transmission cable causes voltage down, therefore, the length limitation should be obeyed to secure proper transmission.

| | | | |
|----------------------------------------------|----------------------------------------------------------|------------------------------------------------------------------------|----------------------------------------|
| Max. length via Outdoor (M-NET cable) | $L1+L2+L3, L1+L2+L4+L5, L3+L4+L5, L6+L2+L3, L6+L2+L4+L5$ | $\leq 500\text{m}(1000\text{m}^*1)[1640\text{ft.}(3280\text{ft.}^*1)]$ | 1.25mm ² [AWG16] or thicker |
| Max. length to Outdoor (M-NET cable) | $L1+L6, L3, L2+L4+L6, L5$ | $\leq 200\text{m}[656\text{ft.}]$ | 1.25mm ² [AWG16] or thicker |
| Max. length from MA to Indoor for each group | $a1+a2, a1+a2+a3+a4$ | $\leq 200\text{m}[656\text{ft.}]$ | 0.3-1.25 mm ² [AWG22-16] |
| 24VDC to AG-150A | n | $\leq 50\text{m}[164\text{ft.}]$ | 0.75-2.0 mm ² [AWG18-14] |

*1 When the wiring length exceeds 500 m (1640 ft), consult the sales office.

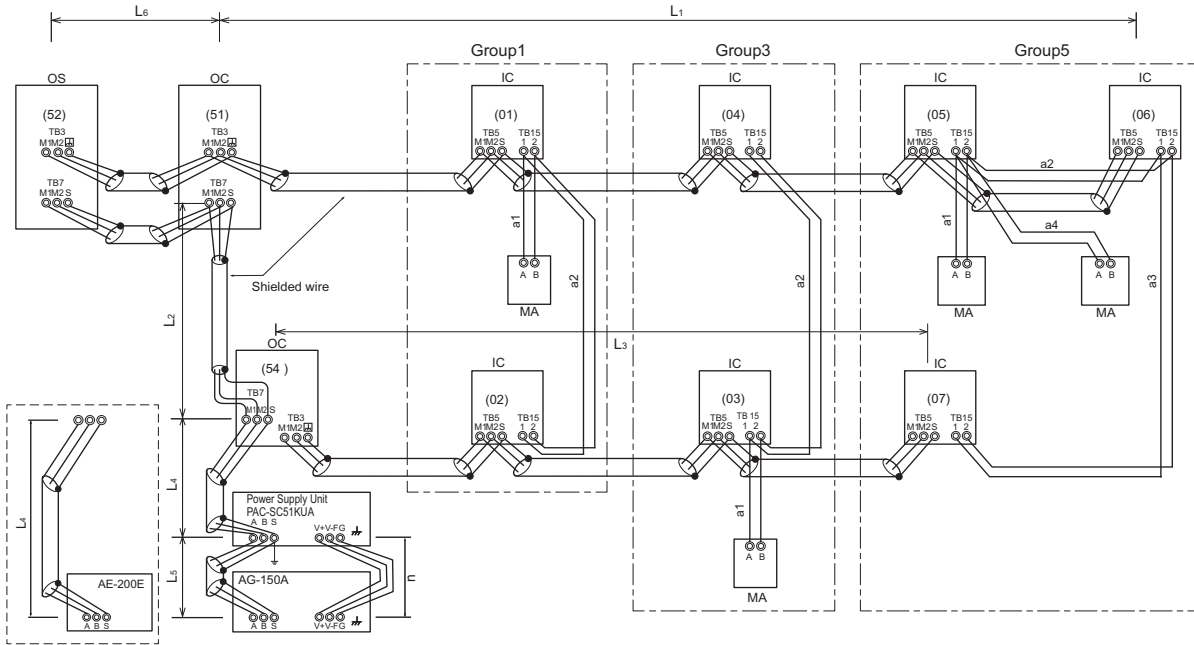

OC, OS: Outdoor unit controller; IC: Indoor unit controller; MA: MA remote controller

11-1-2. Using ME Remote controller

Long transmission cable causes voltage down, therefore, the length limitation should be obeyed to secure proper transmission.

| | | | |
|---------------------------------------|----------------------------------------------------------------------------------------------------------|------------------------------------------------------------------------|----------------------------------------|
| Max. length via Outdoor (M-NET cable) | $L1+L2+L3+L4, L1+L2+L6+L7, L1+L2+L3+L5, L3+L4+L6+L7, L8+L2+L3+L4, L8+L2+L3+L5, L8+L2+L6+L7, L3+L5+L6+L7$ | $\leq 500\text{m}(1000\text{m}^*1)[1640\text{ft.}(3280\text{ft.}^*1)]$ | 1.25mm ² [AWG16] or thicker |
| Max. length to Outdoor (M-NET cable) | $L1+L8, L3+L4, L2+L6+L8, L7, L3+L5$ | $\leq 200\text{m}[656\text{ft.}]$ | 1.25mm ² [AWG16] or thicker |
| Max. length from ME to Indoor | $e1, e2, e3, e4$ | $\leq 10\text{m}[32\text{ft.}]^*2$ | 0.3-1.25 mm ² [AWG22-16] *2 |
| 24VDC to AG-150A | n | $\leq 50\text{m}[164\text{ft.}]$ | 0.75-2.0 mm ² [AWG18-14] |

*1 When the wiring length exceeds 500 m (1640 ft), consult the sales office.

*2. If the length from ME to Indoor exceed 10m, use 1.25 mm² [AWG16] shielded cable, but the total length should be counted into Max. length via Outdoor.

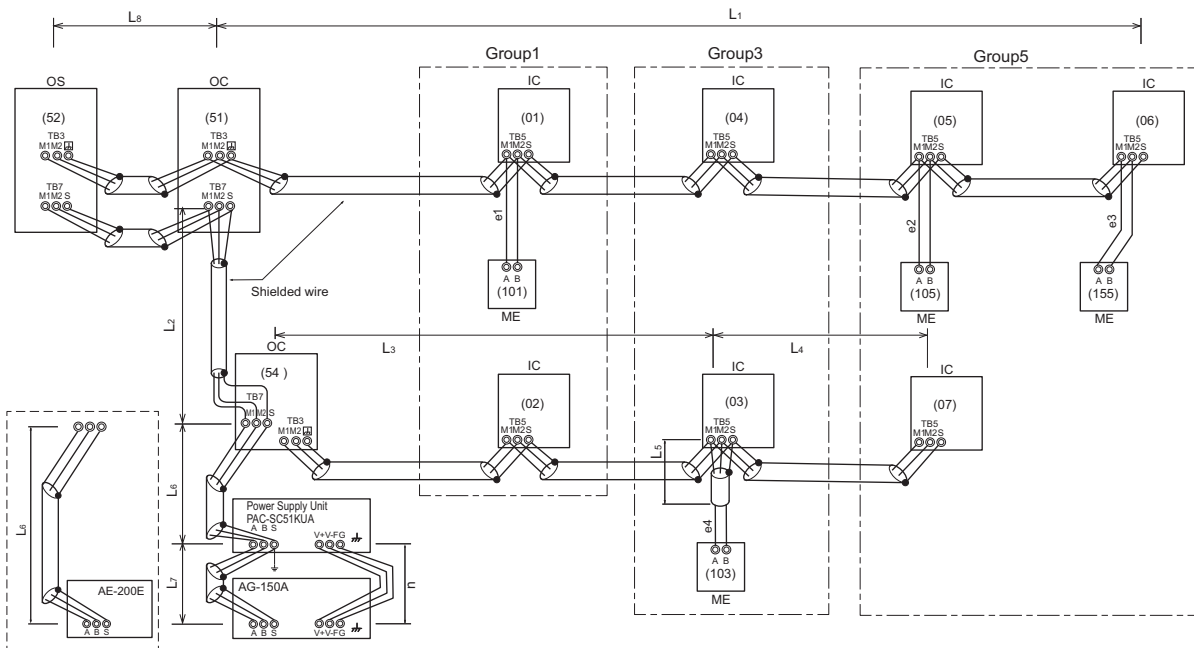

OC, OS: Outdoor unit controller; IC: Indoor unit controller; ME: ME remote controller

11-2. Transmission cable specifications

| | Transmission cables (Li) | M-NET remote controller cables (ei) | MA Remote controller cables (ai) |
|---------------|------------------------------------------------|----------------------------------------------------------------------------------------------|-------------------------------------------|
| Type of cable | Shielding wire (2-core) CVVS, CPEVS or MVVS | Sheathed 2-core cable (unshielded) CVV | |
| Cable size | More than 1.25 mm ² [AWG16] | 0.3 ~ 1.25 mm ² [AWG22~16] | 0.3 ~ 1.25 mm ² [AWG22 ~ 16]*1 |
| Remarks | Max length: within 200 m | When 10 m [32ft] is exceeded, use cables with the same specification as transmission cables. | Max length: 200 m [656ft] |

*1 To wire PAR-CT01MA, PAR-4XMAA, PAR-3XMAA ("X" represents 0 or later), and Simple MA remote controller, use a wire with a diameter of 0.3 mm² [AWG22]

CVVS, MVVS: PVC insulated PVC sheathed shielded control cable
CPEVS: PE insulated PVC sheathed shielded communication cable
CVV: PVC insulated PVC sheathed control cable

11-3. System configuration restrictions

11-3-1. Common restrictions for the CITY MULTI system

For each Outdoor/Heat source unit, the maximum connectable quantity of Indoor unit is specified at its Specifications table.

- A) 1 Group of Indoor units can have 1-16 Indoor units;
*OA processing unit GUF-RD(H) is considered as Indoor unit.
- B) Maximum 2 remote controllers for 1 group;
*MA/ME remote controllers cannot be present together in 1group.
*When a PAR-CT01MA, PAR-4XMAA, or PAR-3XMAA ("X" represents 0 or later) is connected to a group, no other MA remote controllers can be connected to the same group.
- C) 1 Lossnay unit can interlock maximum 16 Indoor units; 1 Indoor unit can interlock only 1 Lossnay unit.
- D) Maximum 3 System controllers are connectable when connecting to TB3 of the Outdoor/Heat source unit.
- E) A maximum of 6 system controller are connectable to TB3 and TB7 of Outdoor/Heat source unit.
- F) 4 System controllers or more are connectable when connecting to TB7 of the Outdoor/Heat source unit, if the transmission power is supplied by the power supply unit PAC-SC51KUA.
*System controller connected as described in D) would have a risk that the failure of connected Outdoor/Heat source unit would stop power supply to the System controller.

11-3-2. Ensuring proper communication power and the number of connected units for M-NET

In order to ensure proper communication among Outdoor/Heat source unit, Indoor unit, Lossnay, OA processing unit GUF-RD(H), and Controllers, the transmission power situation for the M-NET should be observed. In some cases, Transmission booster should be used. Taking the power consumption of Indoor unit as 1, the equivalent power consumption or supply of others are listed at Table 1 and Table 2.

Both the transmission line for centralized controller and indoor-outdoor transmission line must meet the conditions listed below. (Both conditions a) and b) must be met.)

- a) [Total equivalent power consumption] ≤ [The equivalent power supply]
- b) [Total equivalent number of units (Table 1)] ≤ [40]

Table 1 The equivalent power consumption and the equivalent number of units

| Category | Model | The equivalent power consumption | The equivalent number of units |
|------------------------------------------------------------------------------------------------|----------------------------------------------------------------------------------------------------------------------------------------------------|----------------------------------|--------------------------------|
| CITY MULTI indoor unit OA unit CITY MULTI connection kit Air handling unit controller | Except for the models indicated by *2 PEFY-AF2500, 3000, 4000, 5000, 6000MH GUF-50, 100 PAC-LV11M-J PAC-AH125, 140, 250, 500M-J | 1 | 1 |
| CITY MULTI indoor unit *2 | PDFY-P100VM-E-RE | 2 | 2 |
| BC controller | CMB | 2 | 1 |
| PWFY *1 | P100VM-E-BU | 6 | 1 |
| | P200VM-E1-AU P200VM-E2-AU | 5 | 1 |
| | (E)P100VM-E1-AU (E)P100VM-E2-AU P140VM-E1-AU P140VM-E2-AU | 1 | 1 |
| | | | |
| PFAV | P250, 300, 500, 600VM-E(-F) | 1 | 1 |
| | P750, 900VM-E(-F) | 2 | 2 |
| PFV, PEV | P200, 250, 400, 500YM-A | 1 | 1 |
| MA remote controller/Lossnay | PAR-CT01MA PAR-21MA PAR-31MA PAR-32MA PAR-33MA PAR-40MA PAC-YT52CRA PAR-FA32MA LGH PZ-60DR-E PZ-61DR-E PZ-43SMF-E | 0 | 0 |
| ME remote controller | PAR-U02MEDA | 0.5 | 1 |
| | PZ-52SF | 0.25 | 1 |
| System controller | AE-200E AE-50E EW-50E LM-AP | 0 | 0 |
| | AG-150A EB-50GU-J PAC-IF01AHC-J | 0.5 | 1 |
| | AT-50B | 1.5 | 5 |
| | PAC-YG60MCA PAC-YG66DCA PAC-YG63MCA | 0.25 | 1 |
| ON/OFF controller | PAC-YT40ANRA | 1 | 1 |
| MN converter | CMS-MNG-E | 2 | 1 |
| Outdoor/Heat source unit | TB7 power consumption | 0 | 0 |
| System control interface | MAC-333IF-E | 0 | 0 |
| A-M converter | PAC-SF83MA-E | | |

*1 PWFY cannot be connected to PUMY model.

Table 2 The equivalent power supply

| Category | Model | The equivalent power supply | | |
|--------------------------|-----------------------------------------|-----------------------------|----------|----------------------------------------|
| Transmission Booster | PAC-SF46EPA-G | 25 *1 | | |
| Power supply unit | PAC-SC51KUA | 5 | | |
| Expansion controller | PAC-YG50ECA | 6 | | |
| BM ADAPTER | BAC-HD150 | 6 | | |
| System controller | AE-200E/AE-50E | 0.75 | | |
| | EW-50E | 1.5 | | |
| | LM-AP | 0 | | |
| Outdoor/Heat source unit | | TB3 and TB7 total | TB7 only | TB3 only |
| | Outdoor unit except S-Series and TKA *2 | 32 *1 | 6 | 32 *1-equivalent power supplied to TB7 |
| | S-Series outdoor unit | 12 *1 | 0 | 12 *1 |
| | TKA outdoor unit | 32 *1 | - *3 | 32 *1 |

*1 When one or more indoor units listed below is connected, subtract 3 from the equivalent power supply.

Table 3

| Category | Model |
|------------------------------|----------------------------------------------------------------|
| Indoor unit | Sized P200/P250 |
| | PEFY-AF4000/5000/6000MH, PFFY-P400/500YM-E, PFFY-P400/500YMH-C |
| | PFFY-P300/600YM-E-F, PFFY-P300/600YM-C-F, PDFY-P100VM-E-RE |
| | |
| Air handling unit controller | PAC-AH250/500M-J |
| PFAV | PFAV-P500/600/750/900VM-E(-F) |
| PFV | PFV-P400/500YM-A |
| PEV | PEV-P400/500YM-A |

*2 If PAC-SC51KUA is used to supply power at TB7 side, no power supply need from Outdoor/Heat source unit at TB7, Connector TB3 itself will therefore have 32.

*3 Do not supply power to TB7 from TKA outdoor units.

Use PAC-SC51KUA or PAC-SF46EPA-G when connecting an M-NET device to TB7.

With the equivalent power consumption values and the equivalent number of units in Table 1 and Table 2, PAC-SF46EPA-G can be designed into the air-conditioner system to ensure proper system communication according to (A), (B), (C).

- (A) Firstly, count from TB3 at TB3 side the total equivalent number of units of Indoor units, OA processing units, ME remote controller, and System controllers. If the total equivalent number of units reaches 40, a PAC-SF46EPA-G should be set.
- (B) Secondly, count from TB7 side to TB3 side the total transmission power consumption. If the total equivalent power supply reaches 32, a PAC-SF46EPA-G should be set. Yet, if a PAC-SC51KUA or another controller with a built-in power supply, such as PAC-YG50ECA, is used to supply power at TB7 side, count from TB3 side only.
- (C) Thirdly, count from TB7 at TB7 side the total transmission power consumption, If the total equivalent power supply for only TB7 reaches 6, a PAC-SF46EPA-G should be set. Also, count from TB7 at TB7 side the total equivalent number of units of System controllers, and so on. If the total equivalent number of units reaches 40, a PAC-SF46EPA-G should be set.

* The equivalent power supply of S-Series outdoor unit is 12.

* When one or more indoor units listed in Table 3 is connected, subtract 3 from the equivalent power supply.

■ System example

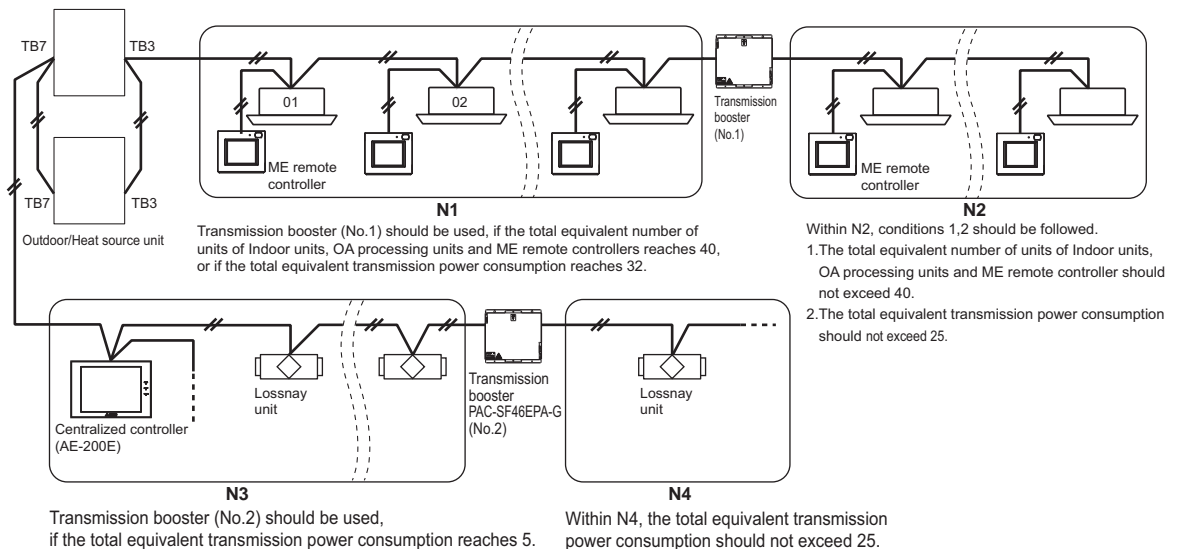

11-3-3. Ensuring proper power supply to System controller

The power to System controller (excluding AE-200E, AE-50E, EW-50E, BAC-HD150, LM-AP) is supplied via M-NET transmission line. M-NET transmission line at TB7 side is called Centralized control transmission line while one at TB3 side is called Indoor-Outdoor/Heat source transmission line. There are 3 ways to supply power to the System controller .

- A) Connecting to TB3 of the Outdoor/Heat source unit and receiving power from the Outdoor/Heat source unit.
- B) Connecting to TB7 of the Outdoor/Heat source unit and receiving power from the Outdoor/Heat source unit. (Not applicable to the PUMY model)
- C) Connecting to TB7 of the Outdoor/Heat source unit but receiving power from power supply unit PAC-SC51KUA.

* System controllers (AE-200E, AE-50E, EW-50E, BAC-HD150, LM-AP) have a built-in function to supply power to the M-NET transmission lines, so no power needs to be supplied to the M-NET transmission lines from the Outdoor/Heat source units or from PAC-SC51KUA.

11-3-3-A. When connecting to TB3 of the Outdoor/Heat source unit and receiving power from the Outdoor/Heat source unit.

Maximum 3 System controllers can be connected to TB3. If there is more than 1 Outdoor/Heat source unit, it is necessary to replace power supply switch connector CN41 with CN40 on one Outdoor/Heat source unit.

Fig. 11-3-3-A

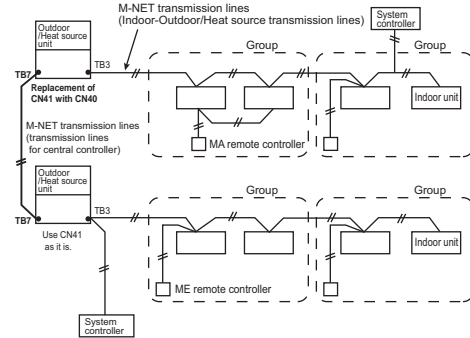

11-3-3-B. When connecting to TB7 of the Outdoor/Heat source unit and receiving power from the Outdoor/Heat source unit. (Not applicable to the PUMY model)

A maximum of 6 system controller are connectable to TB3 and TB7 of Outdoor/Heat source unit. (Not applicable to the PUMY model) It is necessary to replace power supply switch connector CN41 with CN40 on one Outdoor/Heat source unit.

Fig. 11-3-3-B

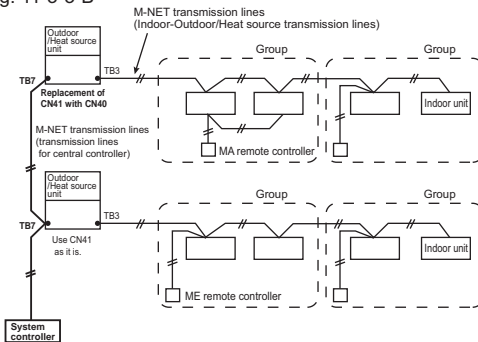

11-3-3-C. When connecting to TB7 of the Outdoor/Heat source unit but receiving power from PAC-SC51KUA.

When using PAC-SC51KUA to supply transmission power, the power supply connector CN41 on the Outdoor/Heat source units should be kept as it is. It is also a factory setting. 1 PAC-SC51KUA supports maximum 1 AG-150A or 1 EB-50GU-J unit due to the limited power 24VDC at its TB3. However, 1 PAC-SC51KUA supplies transmission power at its TB2 equal to 5 Indoor units, which is referable at Table 2. If System controller, ON/OFF controller connected to TB7 consume transmission power more than 5 (Indoor units), Transmission booster PAC-SF46EPA-G is needed. PAC-SF46EPA-G supplies transmission power equal to 25 Indoor units.

Fig. 11-3-3-C

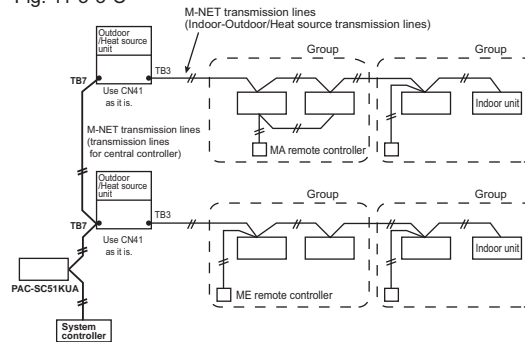

CAUTION

- AG-150A/EB-50GU-J*1 are recommended to connect to TB7 because it performs back-up to a number of data.
- In an air conditioner system has more than 1 Outdoor/Heat source units, AG-150A/EB-50GU-J receiving transmission power at TB3 or TB7 on one of the Outdoor/Heat source units would have a risk that the connected Outdoor/Heat source unit failure would stop power supply to AG-150A/EB-50GU-J, and disrupt the whole system.
- When applying apportioned electric power function, AG-150A/EB-50GU-J are necessary to connected to TB7 and has its own power supply unit PAC-SC51KUA.
- Note: Power supply unit PAC-SC51KUA is for AG-150A/EB-50GU-J.
- *1: AG-150A is an example model of system controllers.

Fig. 11-3-3-D

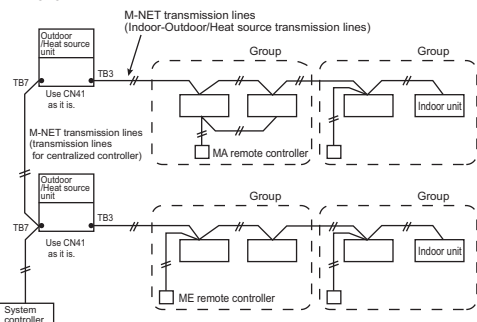

- How to connect system controllers (AE-200E, AE-50E, EW-50E, BAC-HD150, LM-AP) to a given system System controllers (AE-200E, AE-50E, EW-50E, BAC-HD150, LM-AP) have a built-in function to supply power to the M-NET transmission lines, so no power needs to be supplied to the M-NET transmission lines from the Outdoor/Heat source units or from PAC-SC51KUA. Leave the power supply connector on the Outdoor/Heat source unit connected to CN41 as it is. Refer to 11-3-2 for information about the power-supply capacity of each system controller (EW-50E, BAC-HD150, LM-AP) to the low-level system controllers.

11-3-4. Power supply to LM-AP

1-phase 220-240VAC power supply is needed.

The power supply unit PAC-SC51KUA is not necessary when connecting only the LM-AP. Yet, make sure to change the power supply changeover connector CN41 to CN40 on the LM-AP.

11-3-5. Power supply to expansion controller

1-phase 100-240VAC power supply is needed.

The power supply unit PAC-SC51KUA is not necessary.

The expansion controller supplies power through TB3, which equals 6 indoor units. (refer to Table 2)

11-3-6. Power supply to BM ADAPTER

1-phase 100-240VAC power supply is needed.

The power supply unit PAC-SC51KUA is not necessary when only BM ADAPTER is connected.

Yet, make sure to move the power jumper from CN41 to CN40 on the BM ADAPTER.

11-3-7. Power supply to AE-200E/AE-50E/EW-50E

1-phase 100-240VAC power supply is needed.

The power supply unit PAC-SC51KUA is not necessary when connecting only the AE-200E/AE-50E/EW-50E.

11-4. Address setting

11-4-1. Switch operation

In order to constitute CITY MULTI in a complete system, switch operation for setting the unit address No. and connection No. is required.

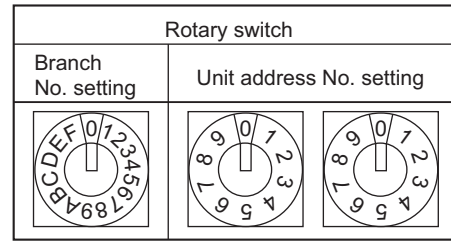

- ① Address No. of outdoor unit, indoor unit and remote controller.
The address No. is set at the address setting board.
In the case of R2 system, it is necessary to set the same No. at the branch No. switch of indoor unit as that of the BC controller connected. (When connecting two or more branches, use the lowest branch No.)

- ② Caution for switch operations
 - Be sure to shut off power source before switch setting. If operated with power source on, switch can not operate properly.
 - No units with identical unit address shall exist in one whole air conditioner system. If set erroneously, the system can not operate.

- ③ MA remote controller
 - When connecting only one remote controller to one group, it is always the main remote controller. When connecting two remote controllers to one group, set one remote controller as the main remote controller and the other as the sub remote controller.
 - The factory setting is "Main".

PAR-4XMAA, PAR-3XMAA ("X" represents 0 or later), PAR-CT01MA
The MA remote controller does not have the switches listed above.
Refer to the installation manual for the function setting.





































PAC-YT52CRA

Setting the dip switches

There are switches on the back of the top case. Remote controller Main/Sub and other function settings are performed using these switches. Ordinarily, only change the Main/Sub setting of SW1.
(The factory settings are ON for SW1, 2, and 3 and OFF for SW4.)

| SW No. | SW contents Main | ON | OFF | Comment |
|--------|--------------------------------------|---------|------------|-----------------------------------------------------------------------------------------|
| 1 | Remote controller Main/Sub setting | Main | Sub | Set one of the two remote controllers at one group to "ON". |
| 2 | Temperature display units setting | Celsius | Fahrenheit | When the temperature is displayed in [Fahrenheit], set to "OFF". |
| 3 | Cooling/heating display in AUTO mode | Yes | No | When you do not want to display "Cooling" and "Heating" in the AUTO mode, set to "OFF". |
| 4 | Indoor temperature display | Yes | No | When you want to display the indoor temperature, set to "ON". |

11-4-2. Rule of setting address

| Unit | Address setting | Example | Note |
|------------------------------------------------------------------------------------------------------------------------------------------------------------------------------------------------|------------------------------------------------------------|-------------------------------------------------------------------------------------------------------------------------------------------------------------------------|---------------------------------------------------------------------------------------------------------------------------------------------------------------------------------------------------------------------------------------------------------------------------------------------------------------------------------------------------------------------------------------------------------------------------------------------------------------------------------------------------------------------------------------------------------------------------------------------------------|
| Indoor unit System control interface (MAC-333IF-E) A-M converter (PAC-SF83MA-E) Air handling unit controller (PAC-AH125, 140, 250, 500M-J) CITY MULTI connection Kit (PAC-LV11M-J) | 01 ~ 50 |   | Use the most recent address within the same group of indoor units. Make the indoor units address connected to the BC controller (Sub) larger than the indoor units address connected to the BC controller (Main). If applicable, set the sub BC controllers in an PURY system in the following order: (1) Indoor unit to be connected to the BC controller (Main) (2) Indoor unit to be connected to the BC controller (No.1 Sub) (3) Indoor unit to be connected to the BC controller (No.2 Sub) Set the address so that (1)<(2)<(3) A maximum of 12 BC controllers are connectable. |
| Outdoor unit | 51 ~ 99, 100 (Note1) |   | The smallest address of indoor unit in same refrigerant system + 50 Assign sequential address numbers to the outdoor units in one refrigerant circuit system. OC, OS1 and OS2 are automatically detected. (Note 2) * Please reset one of them to an address between 51 and 99 when two addresses overlap. * The address automatically becomes "100" if it is set as "01 ~ 50" |
| BC controller (Main) | 52 ~ 99, 100 |   | The address of outdoor unit + 1 * Please reset one of them to an address between 51 and 99 when two addresses overlap. * The address automatically becomes "100" if it is set as "01 ~ 50" |
| BC controller (Sub) | 52 ~ 99, 100 |   | Lowest address within the indoor units connected to the BC controller (Sub) plus 50. |
| Local remote controller | ME Remote controller (Main) | 101 ~ 150 Fixed |   * The place of "100" is fixed to "1" |
| | ME Remote controller (Sub) | 151 ~ 199, 200 Fixed |   * The address automatically becomes "200" if it is set as "00" |
| System controller | ON/OFF remote controller | 201 ~ 250 |    * The smallest group No. to be managed + 200 * The smallest group No. to be managed is changeable. |
| | AE-200E/AE-50E AG-150A EB-50GU-J EW-50E AT-50B | 000, 201 ~ 250 |    * AT-50B cannot be set to "000". |
| | PAC-YG50ECA | 000, 201 ~ 250 |    * Settings are made on the initial screen of AG-150A. |
| | BAC-HD150 | 000, 201 ~ 250 |    * Settings are made with setting tool of BM ADAPTER. |
| | LMAP04-E | 201 ~ 250 Fixed |   |
| PI, AI, DIDO | PAC-YG60MCA | 01 ~ 50 |   |
| | PAC-YG63MCA | 01 ~ 50 |   |
| | PAC-YG66DCA | 01 ~ 50 |   |
| Lossnay, OA processing unit | 01 ~ 50 |   | After setting the addresses of all the indoor units, assign an arbitrary address. |
| PAC-IF01AHC | 201 ~ 250 Fixed |   | |

Note1: To set the address to "100", set it to "50"

Note2: Outdoor units OC, OS1 and OS2 in one refrigerant circuit system are automatically detected. OC, OS1 and OS2 are ranked in descending order of capacity. If units are the same capacity, they are ranked in ascending order of their address.

11-4-3. System examples

Factory setting

Original switch setting of the outdoors, indoors, controllers, LM-AP and BM ADAPTER at shipment is as follows.

- Outdoor unit : Address: 00, CN41: ON (Jumper), DipSW5-1: OFF
- Indoor unit : Address: 00
- ME remote controller : Address: 101
- LM-AP : Address: 247, CN41: ON (Jumper), DipSW1-2: OFF
- BM ADAPTER : Address: 000, CN41: ON (Jumper)
- AE-200E/AE-50E/EW-50E : Address: 000, CN21: ON (Jumper)

Setting at the site

- DipSW5-1(Outdoor) : When the System Controller is used, all the Dip SW5-1 at the outdoor units should be set to "ON". * Dip SW5-1 remains OFF when only LM-AP is used.
- DipSW1-2(LM-AP) : When the LM-AP is used together with System Controller, DipSW1-2 at the LM-AP should be set to "ON".
- CN40/CN41 : Change jumper from CN41 to CN 40 at outdoor control board will activate central transmission power supply to TB7;
(Change jumper at only one outdoor unit when activating the transmission power supply without using a power supply unit.)
Change jumper from CN41 to CN 40 at LM-AP/BM ADAPTER will activate transmission power supply to LM-AP/BM ADAPTER itself;
Power supply unit is recommended to use for a system having more than 1 outdoor unit, because the central transmission power supply from TB7 of one of outdoor units is risking that the outdoor unit failure may let down the whole system controller system.
- CN21(AE-200E/AE-50E/EW-50E) : Activates the power supply to M-NET transmission line from AE-200E/AE-50E/EW-50E (CN21: ON (power supplied), OFF (power not supplied))

11-4-3-1. MA remote controller, Single-refrigerant-system, No System Controller

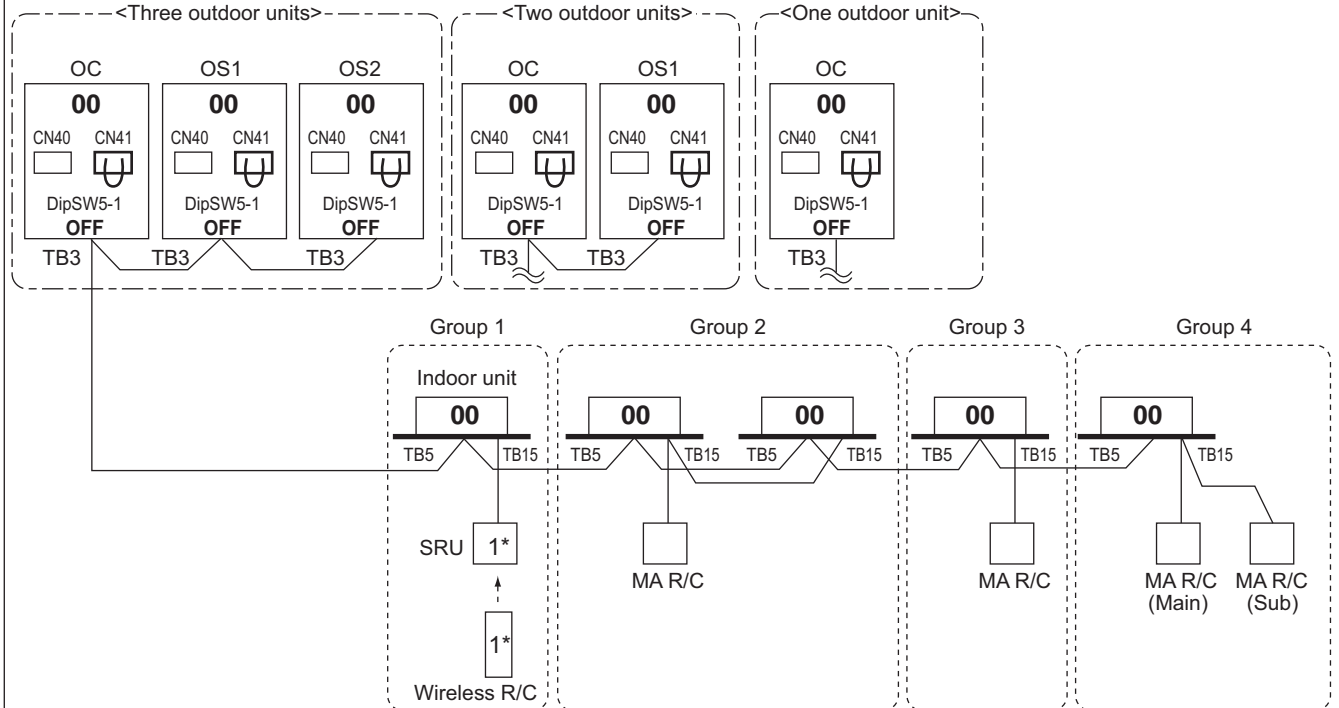

*1 For Wireless R/C and Signal receiver unit (SRU), channel 1, 2 and 3 are selectable and should be set to same channel.

NOTE:

1. Outdoor units OC, OS1 and OS2 in one refrigerant circuit system are automatically detected. OC, OS1 and OS2 are ranked in descending order of capacity. If units are the same capacity, they are ranked in ascending order of their address.
2. No address setting is needed.
3. For a system having more than 32 indoor unit, confirm the need of Booster at 11-3. "System configuration restrictions".
4. When a PAR-CT01MA, PAR-4XMAA, or PAR-3XMAA ("X" represents 0 or later) is connected to a group, no other MA remote controllers can be connected to the same group.

11-4-3-2. MA remote controller, Single-refrigerant-system, System Controller

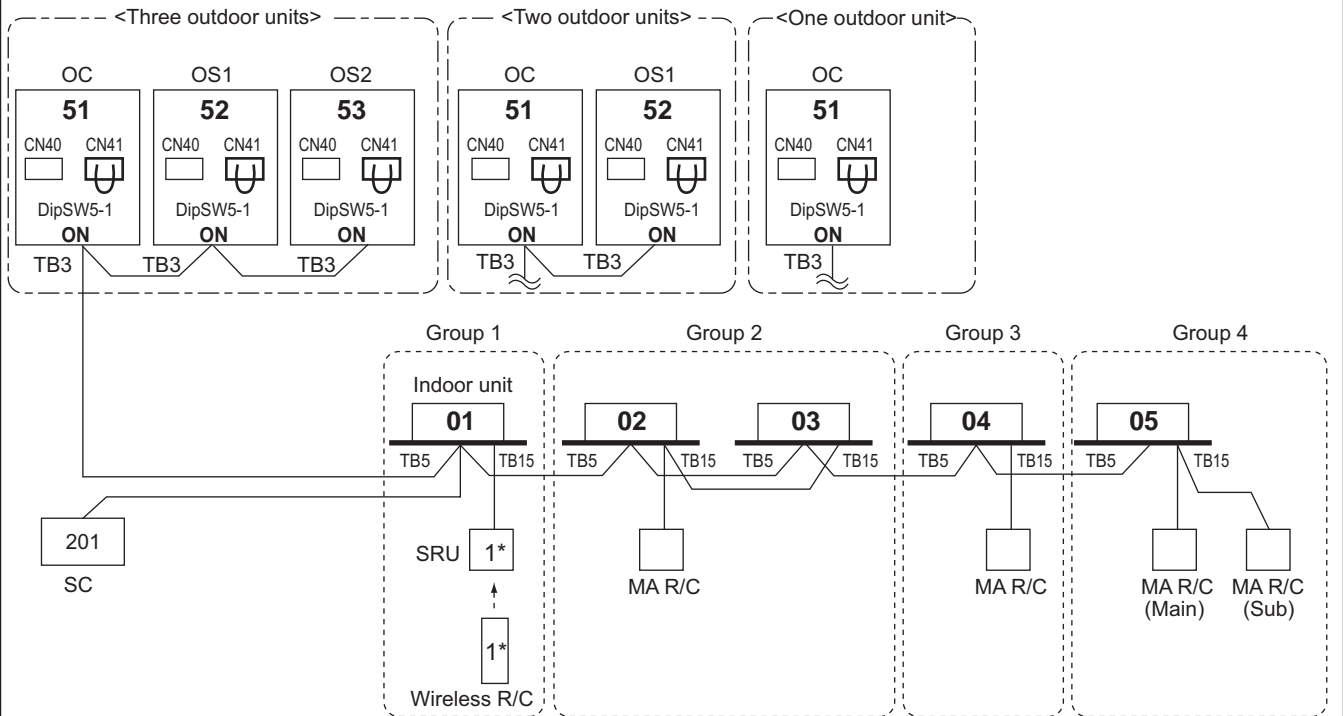

*1 For Wireless R/C and Signal receiver unit (SRU), channel 1, 2 and 3 are selectable and should be set to same channel.

*SC can be connected to TB3 side or TB7 side;

Should SC connected to TB7 side, change Jumper from CN41 to CN40 at the Outdoor unit module so as to supply power to the SC.

NOTE:

1. Outdoor units OC, OS1 and OS2 in one refrigerant circuit system are automatically detected.
OC, OS1 and OS2 are ranked in descending order of capacity. If units are the same capacity, they are ranked in ascending order of their address.
2. Address should be set to Indoor units and centralized controller.
3. For a system having more than 32 indoor unit, confirm the need of Booster at 11-3. **"System configuration restrictions"**.
4. When a PAR-CT01MA, PAR-4XMAA, or PAR-3XMAA ("X" represents 0 or later) is connected to a group, no other MA remote controllers can be connected to the same group.

PUHY-P-Y(S)NW-A1

11-4-3-3. MA remote controller, Multi-refrigerant-system, System Controller at TB7/TB3 side, Booster for long M-NET wiring

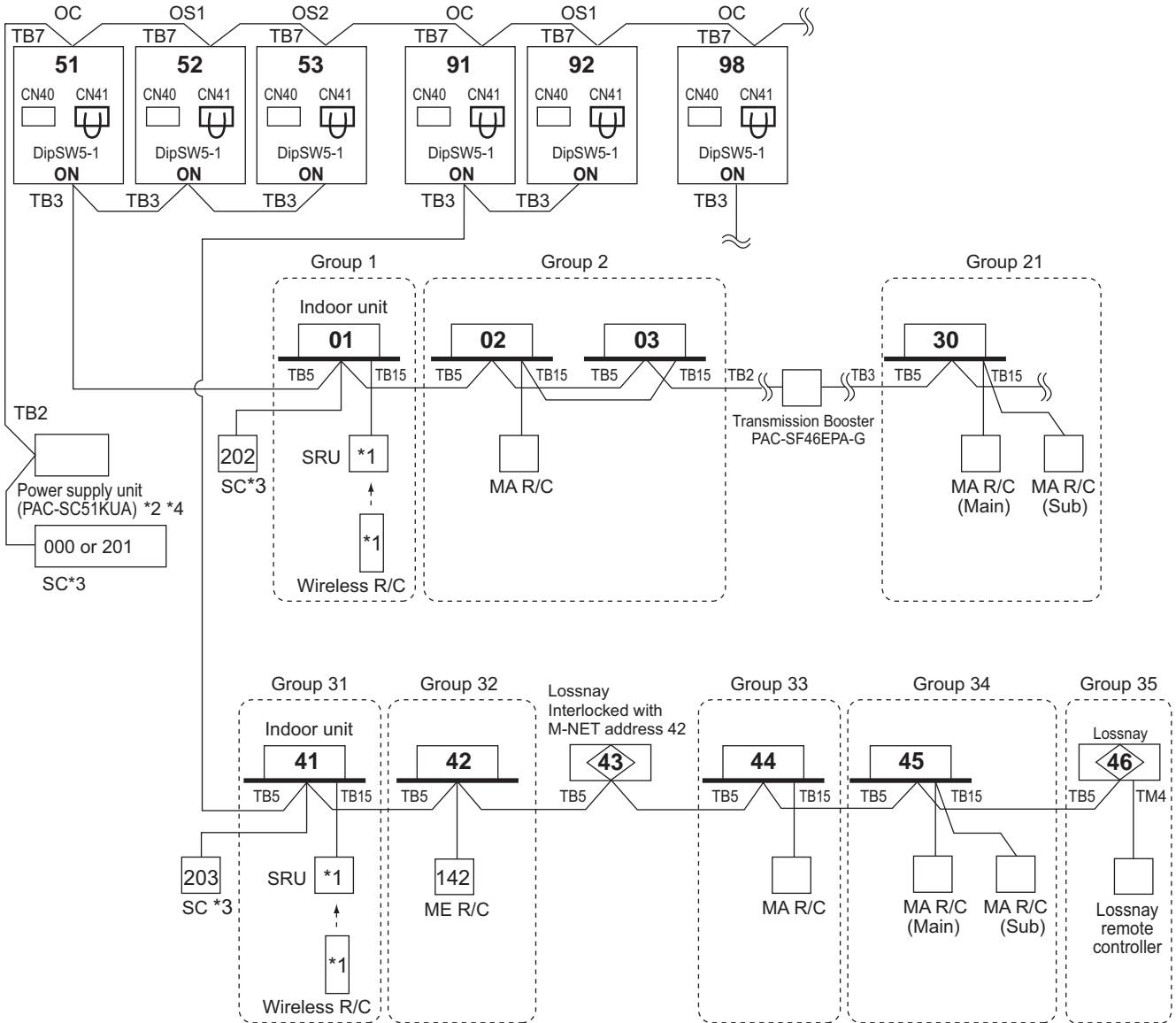

- *1 For Wireless R/C and Signal receiver unit (SRU), channel 1, 2 and 3 are selectable and should be set to same channel.
- *2 System controller should connect to TB7 at Outdoor and use power supply unit together in Multi-Refrigerant-System.
For AG-150A, 24V DC should be used with the PAC-SC51KUA.
For AE-200E, AE-50E, and EW-50E the power supply unit PAC-SC51KUA is unused.
- *3 When multiple system controllers are connected in the system, set the controller with more functions than others as a "main" controller and others as "sub".
AE-200E, AE-50E, EW-50E, and BAC-HD150 are for exclusive use as a "main" system controller and cannot be used as a "sub" system controller.
Make the setting to only one of the system controllers for "prohibition of operation from local remote controller".
- *4 The power supply unit is not necessary for AE-200E, AE-50E, EW-50E, BAC-HD150, and LM-AP.

NOTE:

1. Outdoor units OC, OS1 and OS2 in one refrigerant circuit system are automatically detected.
OC, OS1 and OS2 are ranked in descending order of capacity. If units are the same capacity, they are ranked in ascending order of their address.
2. Address should be set to Indoor units, Lossnay, and system controller.
3. M-NET power is supplied by the Outdoor unit at TB3, while Indoor unit and ME remote controller consume the M-NET power for transmission use. The power balance is needed to consider for long M-NET wiring.
Details refer to 11-3. "System configuration restrictions".
4. When a PAR-CT01MA, PAR-4XMAA, or PAR-3XMAA ("X" represents 0 or later) is connected to a group, no other MA remote controllers can be connected to the same group.

11-4-3-4. ME remote controller, Single-refrigerant-system, No system controller

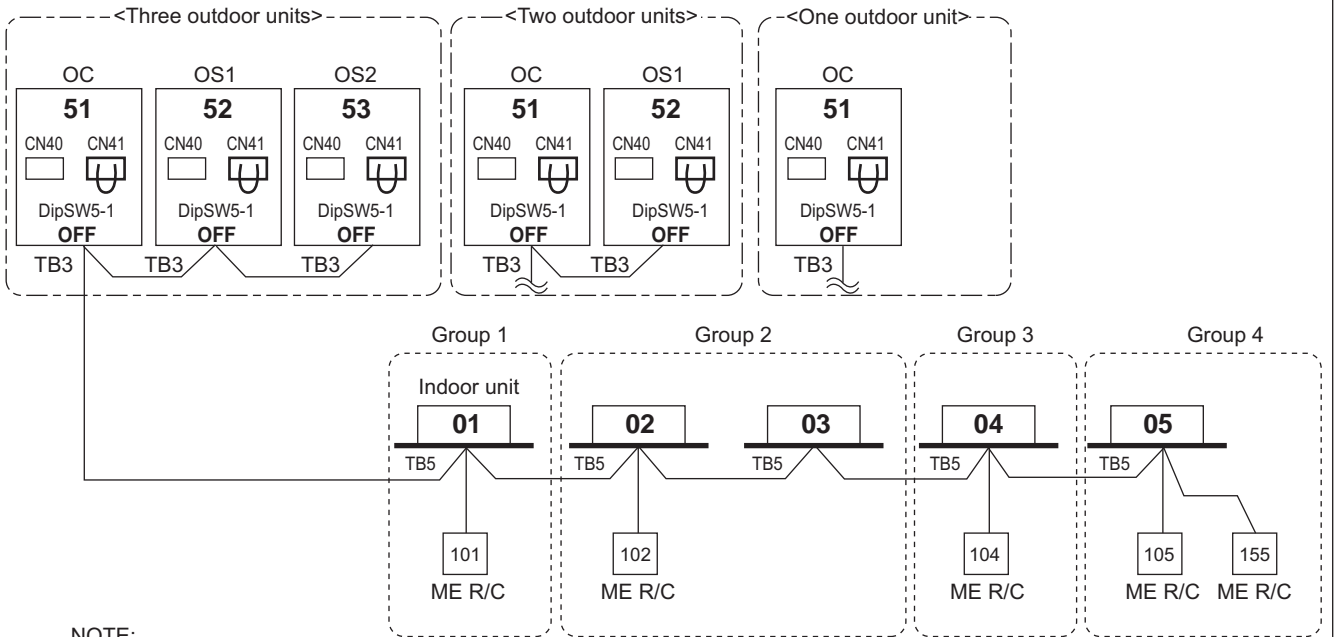

NOTE:

1. Outdoor units OC, OS1 and OS2 in one refrigerant circuit system are automatically detected. OC, OS1 and OS2 are ranked in descending order of capacity. If units are the same capacity, they are ranked in ascending order of their address.
2. Address should be set to Indoor units and ME remote controllers.
3. M-NET power is supplied by the Outdoor unit at TB3, while Indoor unit and ME RC consume the M-NET power for transmission use. The power balance is needed to consider for long M-NET wiring. Details refer to 11-3. "System configuration restrictions".

11-4-3-5. ME remote controller, Single-refrigerant-system, System controller, Lossnay

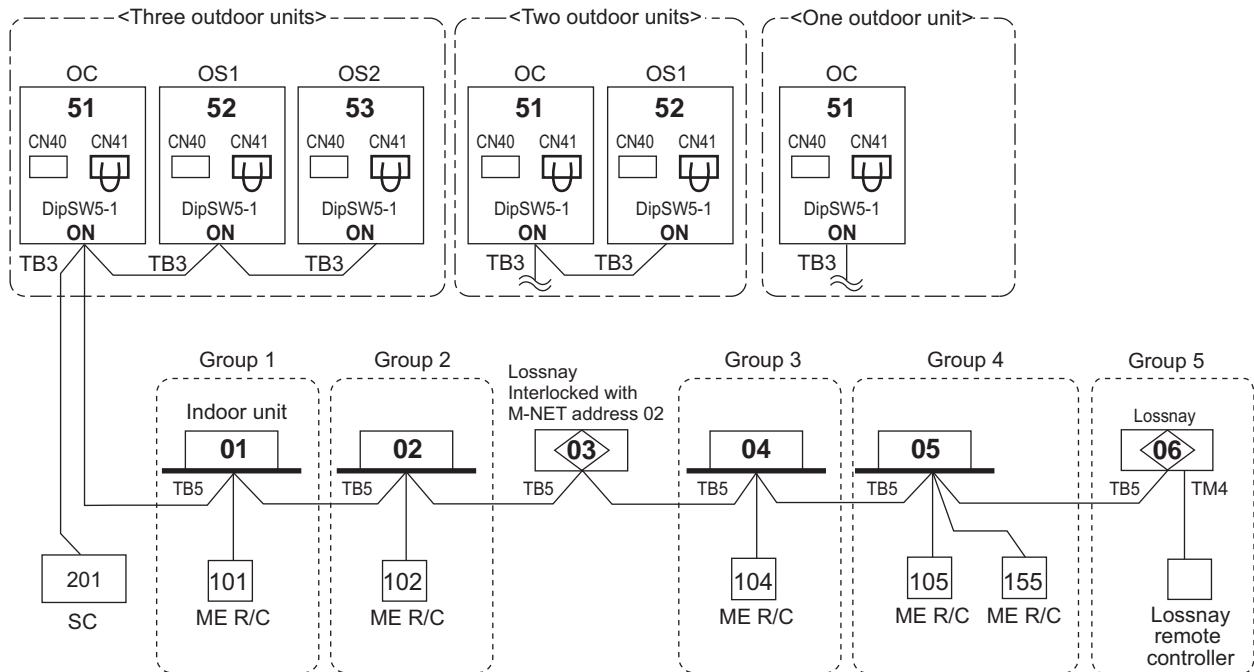

*SC can be connected to TB3 side or TB7 side;

Should SC connected to TB7 side, change Jumper from CN41 to CN40 at the Outdoor unit module so as to supply power to the SC.

NOTE:

1. Outdoor units OC, OS1 and OS2 in one refrigerant circuit system are automatically detected. OC, OS1 and OS2 are ranked in descending order of capacity. If units are the same capacity, they are ranked in ascending order of their address.
2. Address should be set to Indoor units, Lossnay, centralized controller, and ME remote controllers.
3. For a system having more than 32 indoor unit, confirm the need of Booster at 11-3. "System configuration restrictions".

PUHY-P-Y(S)NW-A1

11-4-3-6. ME remote controller, Multi-refrigerant-system, System Controller at TB 7side, Lossnay, Booster for long M-NET wiring

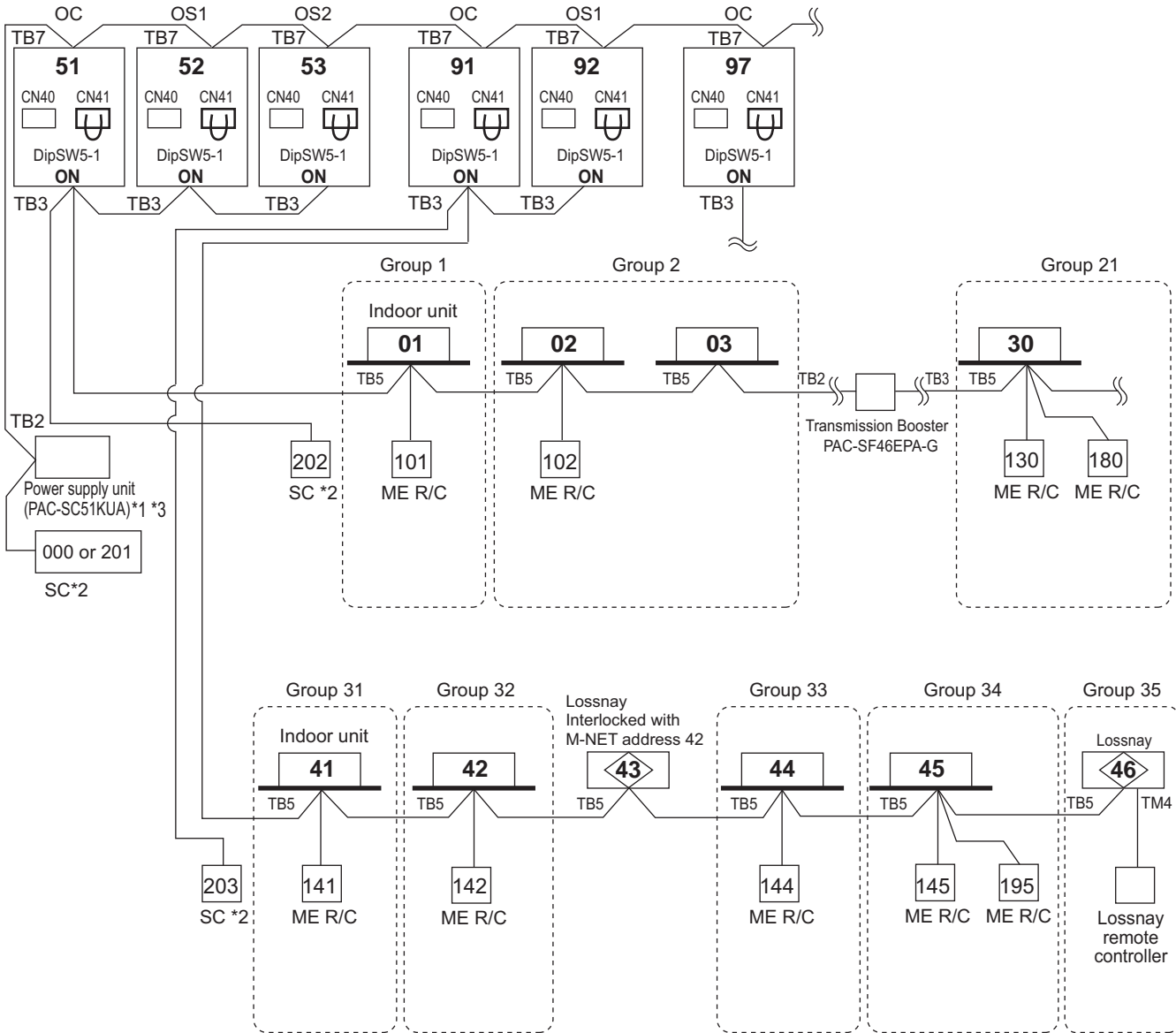

*1 System controller should connect to TB7 at Outdoor and use power supply unit together in Multi-Refrigerant-System.
 For AG-150A, 24V DC should be used with the PAC-SC51KUA.
 For AE-200E, AE-50E, and EW-50E the power supply unit PAC-SC51KUA is unused.

*2 When multiple system controllers are connected in the system, set the controller with more functions than others as a "main" controller and others as "sub".
 AE-200E, AE-50E, EW-50E, and BAC-HD150 are for exclusive use as a "main" system controller and cannot be used as a "sub" system controller.

*3 The power supply unit is not necessary for AE-200E, AE-50E, EW-50E, BAC-HD150, and LM-AP.

NOTE:

- Outdoor units OC, OS1 and OS2 in one refrigerant circuit system are automatically detected. OC, OS1 and OS2 are ranked in descending order of capacity. If units are the same capacity, they are ranked in ascending order of their address.
- M-NET power is supplied by the Outdoor unit at TB3, while Indoor unit and ME remote controller consume the M-NET power for transmission use. The power balance is needed to consider for long M-NET wiring. Details refer to 11-3. "System configuration restrictions".

11-4-3-7. ME remote controller, Multi-refrigerant-system, No Power supply unit

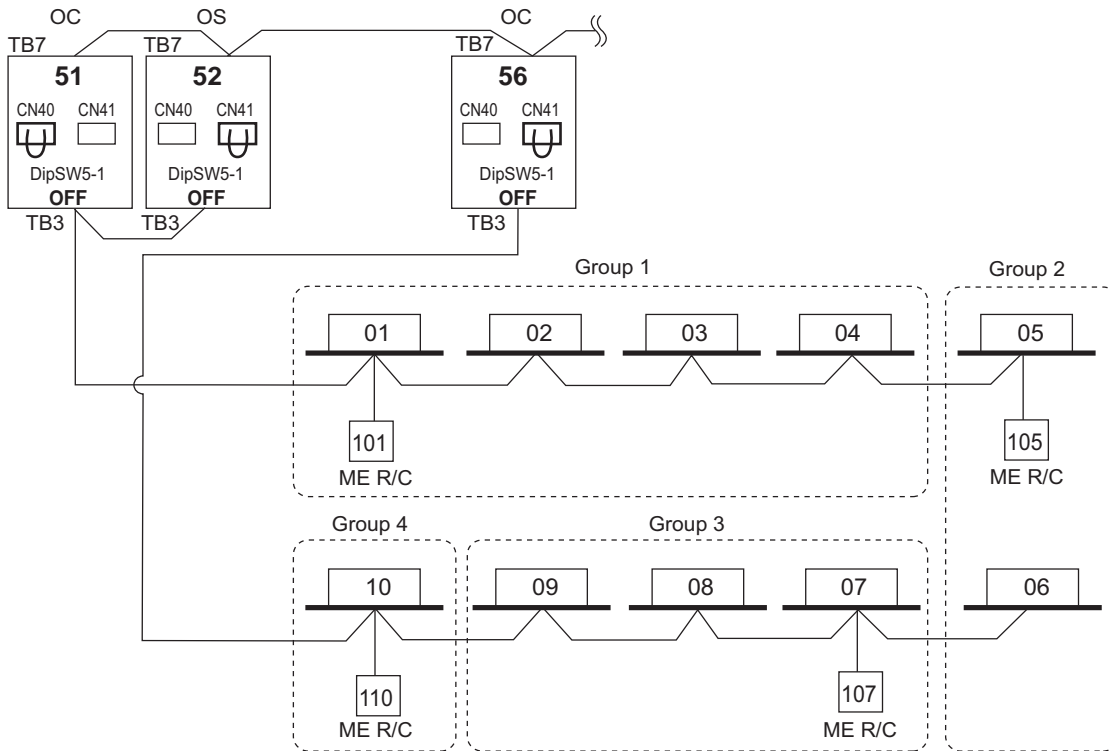

NOTE

- It is necessary to change the connector to CN40 on the outdoor unit control board (only one outdoor unit) when the group is set between other refrigerant systems.
- It is necessary to set on the remote controller by manual when group sets on the different refrigerant system. Please refer to remote controller installation manual.

11-4-3-8. ME remote controller, Multi-refrigerant-system, System Controller at TB7 side, No Power supply unit

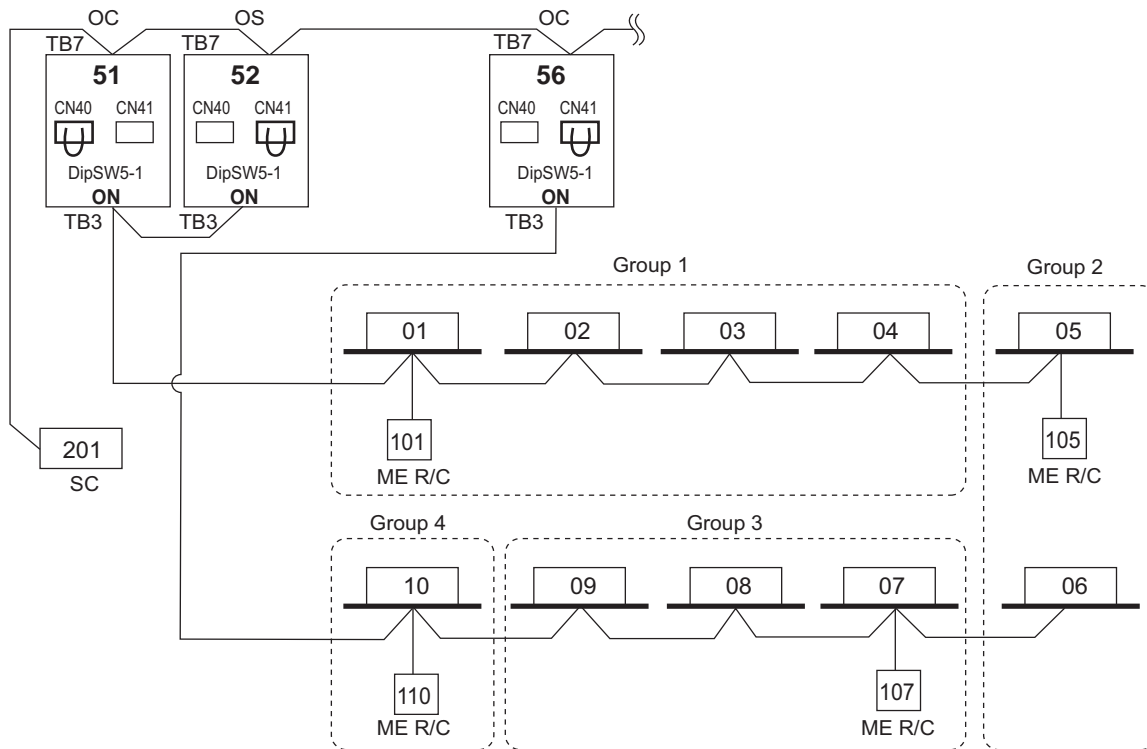

NOTE

- It is necessary to change the connector to CN40 on the outdoor unit control board (only one outdoor unit) when the group is set between other refrigerant systems.
- It is necessary to set on the remote controller by manual when group sets on the different refrigerant system. Please refer to remote controller installation manual.

11-4-3-9. AE-200E + AE-50E/EW-50E

AE-200E can control max. 200 indoor units/via AE-50E/EW-50E.

PUHY-P-Y(S)NW-A1

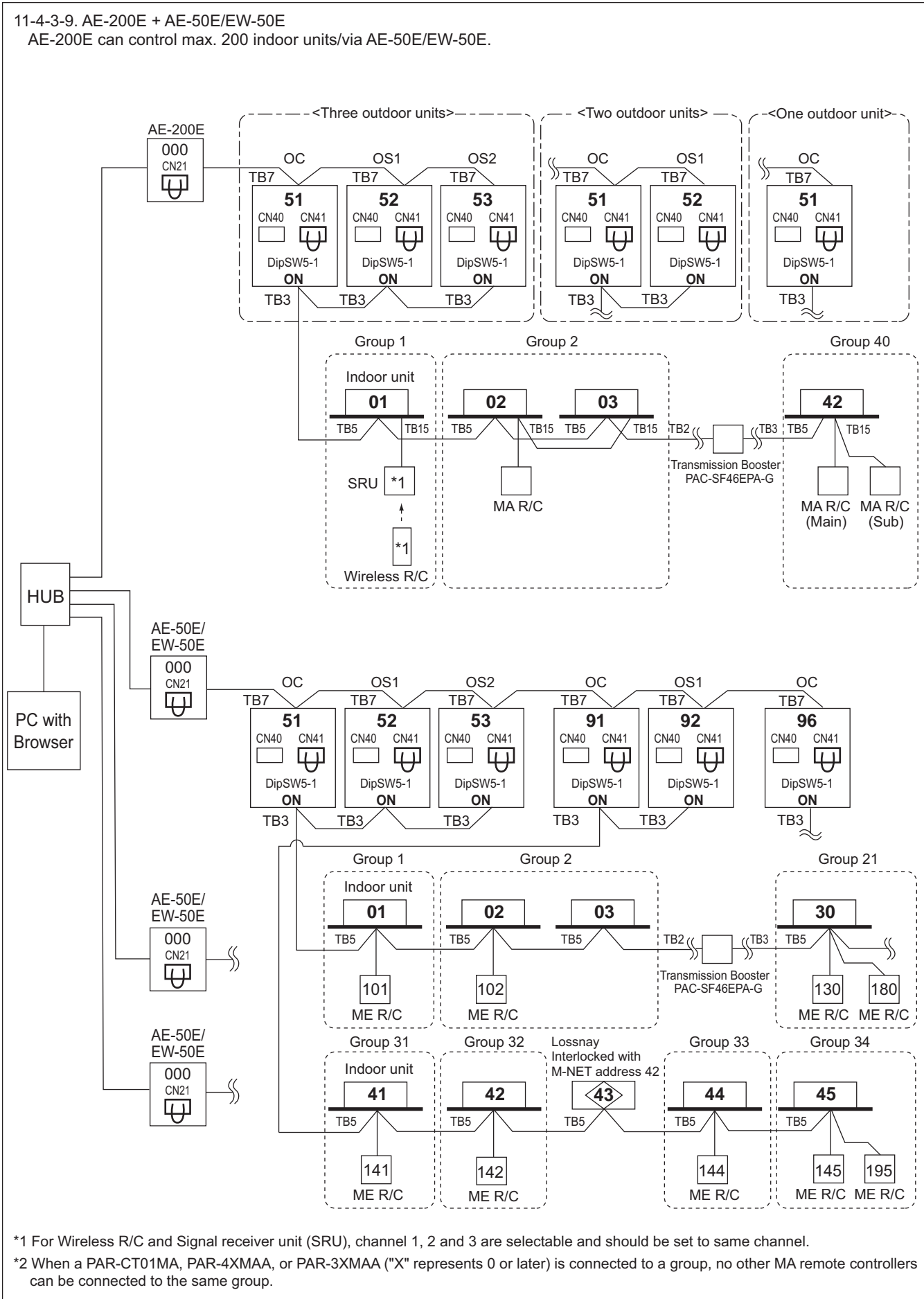

*1 For Wireless R/C and Signal receiver unit (SRU), channel 1, 2 and 3 are selectable and should be set to same channel.

*2 When a PAR-CT01MA, PAR-4XMAA, or PAR-3XMAA ("X" represents 0 or later) is connected to a group, no other MA remote controllers can be connected to the same group.

11-4-3-10. LM-AP

LM-AP can transmit for max. 50 indoor units;

If system controller (SC) is used, DipSW1-2 at LM-AP and DipSW5-1 at Outdoor unit should set to "ON".

Change Jumper from CN41 to CN40 to activate power supply to LM-AP itself for those LM-AP connected without system controller (SC).

LM-AP can transmit for max.

50 indoor units in single-refrigerant-system or multi-refrigerant-system.

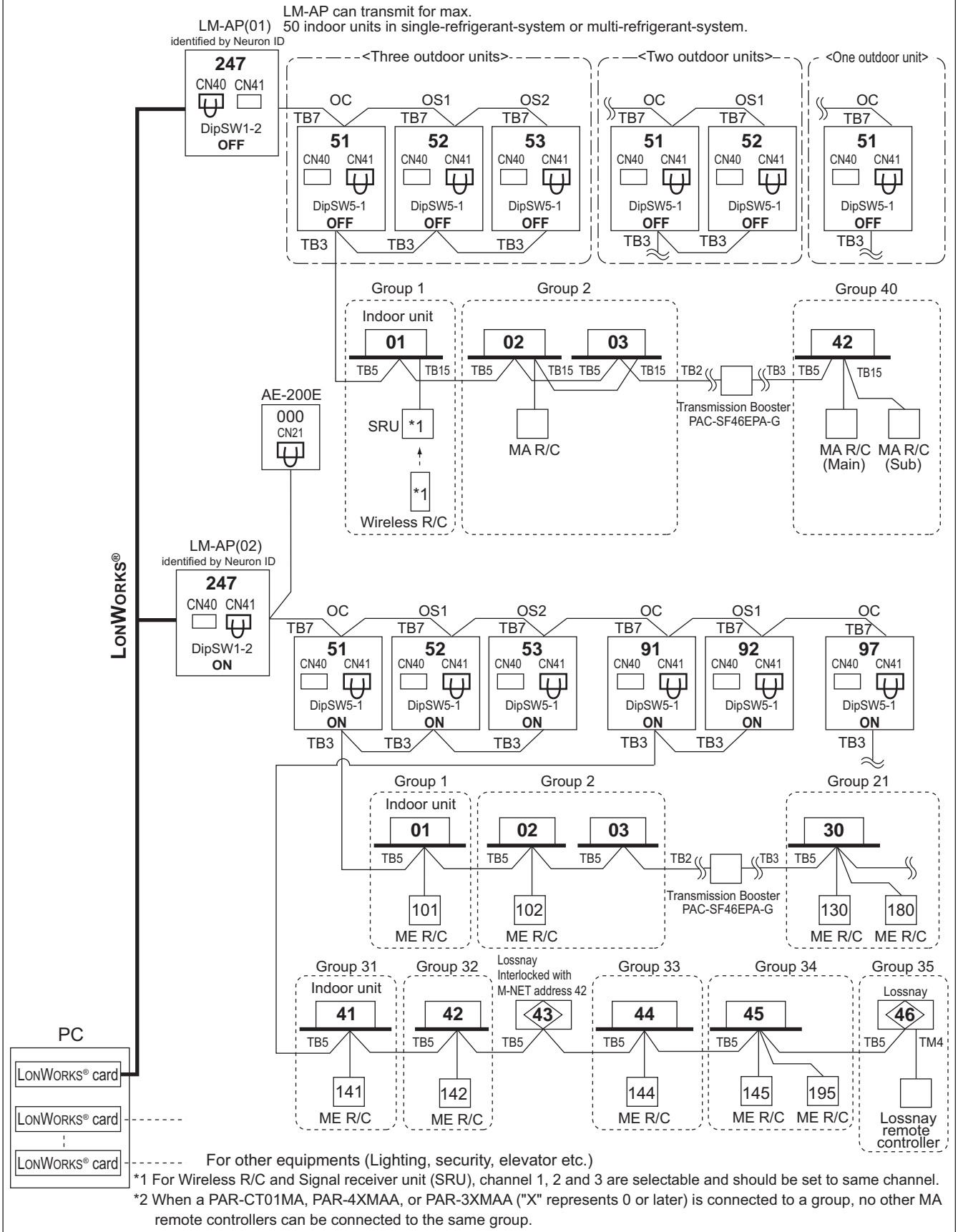

PUHY-P-Y(S)NW-A1

11-4-3-11. BACnet®

EW-50E (AE-200E) can control up to 50 units/groups (including Lossnay).

*To use the BACnet® function on EW-50E (AE-200E), BACnet® license registration is required.

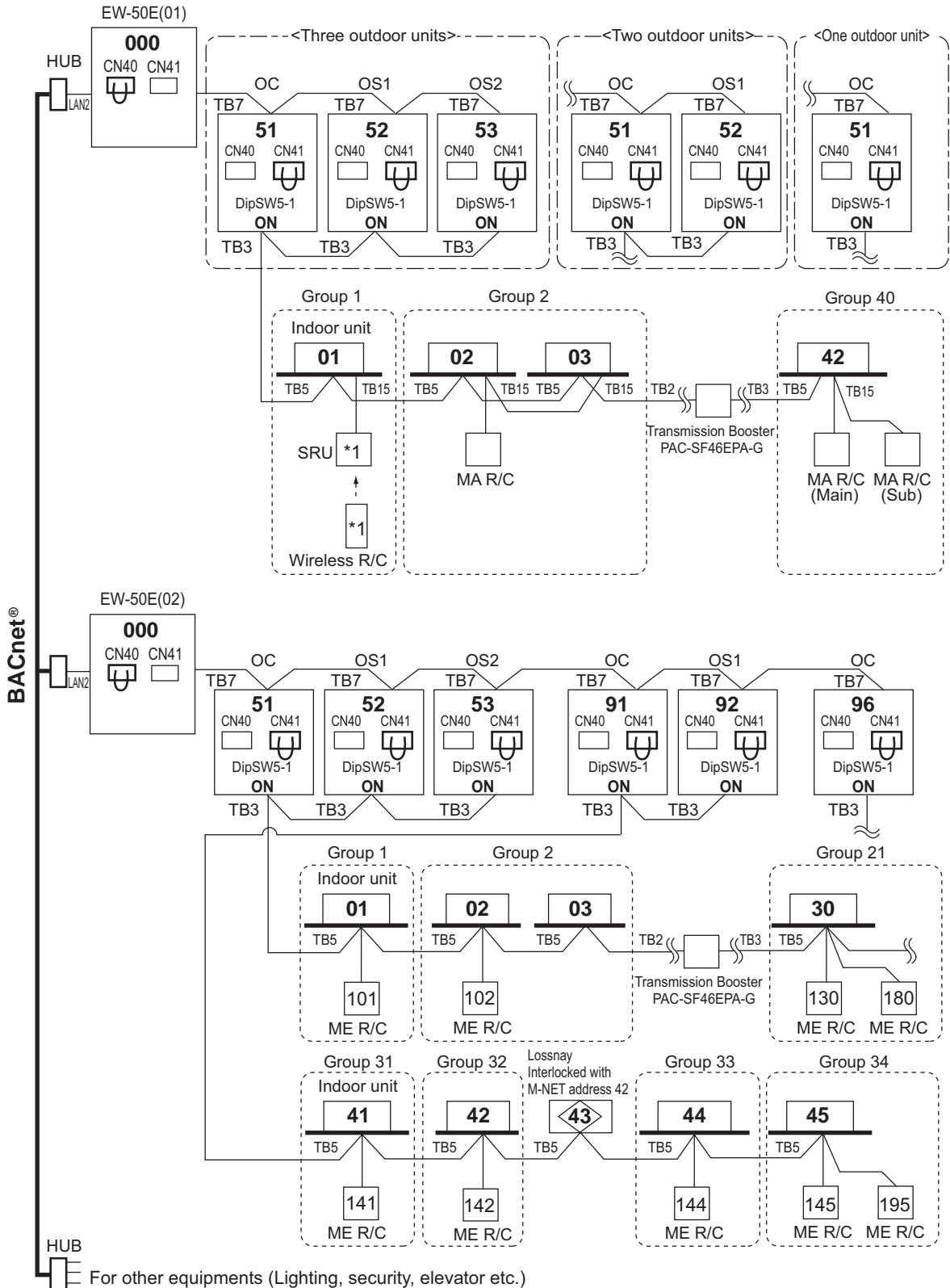

*1 For Wireless R/C and Signal receiver unit (SRU), channel 1, 2 and 3 are selectable and should be set to same channel.

*2 When a PAR-CT01MA, PAR-4XMAA, or PAR-3XMAA ("X" represents 0 or later) is connected to a group, no other MA remote controllers can be connected to the same group.

12-1. R410A Piping material

Refrigerant pipe for CITY MULTI shall be made of phosphorus deoxidized copper, and has two types.

- A. Type-O: Soft copper pipe (annealed copper pipe), can be easily bent with human's hand.
- B. Type-1/2H pipe: Hard copper pipe (Straight pipe), being stronger than Type-O pipe of the same radical thickness.

The maximum operation pressure of R410A air conditioner is 4.30 MPa [623psi]. The refrigerant piping should ensure the safety under the maximum operation pressure. MITSUBISHI ELECTRIC recommends pipe size as Table1, or You shall follow the local industrial standard. Pipes of radical thickness 0.7mm or less shall not be used.

Table 1. Copper pipe size and radial thickness for R410A CITY MULTI.

| Size (mm) | Size (inch) | Radial thickness (mm) | Radial thickness (mil) | Pipe type |
|-----------|-------------|-----------------------|------------------------|----------------|
| ø6.35 | ø1/4" | 0.8 | [32] | Type-O |
| ø9.52 | ø3/8" | 0.8 | [32] | Type-O |
| ø12.7 | ø1/2" | 0.8 | [32] | Type-O |
| ø15.88 | ø5/8" | 1.0 | [40] | Type-O |
| ø19.05 | ø3/4" | 1.2 | [48] | Type-O |
| ø19.05 | ø3/4" | 1.0 | [40] | Type-1/2H or H |
| ø22.2 | ø7/8" | 1.0 | [40] | Type-1/2H or H |
| ø25.4 | ø1" | 1.0 | [40] | Type-1/2H or H |
| ø28.58 | ø1-1/8" | 1.0 | [40] | Type-1/2H or H |
| ø31.75 | ø1-1/4" | 1.1 | [44] | Type-1/2H or H |
| ø34.93 | ø1-3/8" | 1.2 | [48] | Type-1/2H or H |
| ø41.28 | ø1-5/8" | 1.4 | [56] | Type-1/2H or H |

* For pipe sized ø19.05 (3/4") for R410A air conditioner, choice of pipe type is up to you.

* The figures in the radial thickness column are based on the Japanese standards and provided only as a reference. Use pipes that meet the local standards.

Flare

Due to the relative higher operation pressure of R410A compared to R22, the flare connection should follow dimensions mentioned below so as to achieve enough the air-tightness.

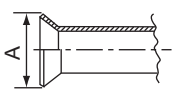
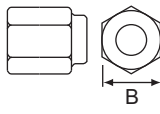
| Flare pipe | Pipe size | A (For R410A) (mm[in.]) | Flare nut | Pipe size | B (For R410A) (mm[in.]) |
|-------------------------------------------------------------------------------------|---------------|-------------------------|--------------------------------------------------------------------------------------|---------------|-------------------------|
|  | ø6.35 [1/4"] | 9.1 |  | ø6.35 [1/4"] | 17.0 |
| | ø9.52 [3/8"] | 13.2 | | ø9.52 [3/8"] | 22.0 |
| | ø12.70 [1/2"] | 16.6 | | ø12.70 [1/2"] | 26.0 |
| | ø15.88 [5/8"] | 19.7 | | ø15.88 [5/8"] | 29.0 |
| | ø19.05 [3/4"] | 24.0 | | ø19.05 [3/4"] | 36.0 |

PUHY-P-Y(S)NW-A1

Procedures for installing the branched pipes

Refer to the instructions that came with the branched pipe kit (separately sold) for details.

[1] Branches on the indoor-unit side

■ **Joint**

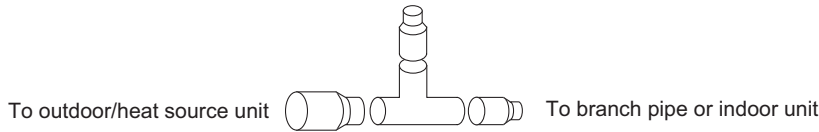

Horizontal installation

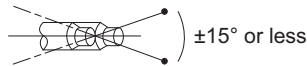

Vertical installation

(The branched pipes must face up.)
Indoor-unit side (branched pipe)

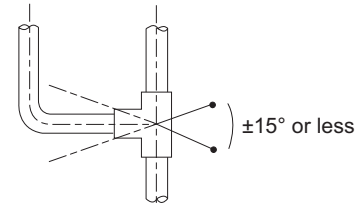

Outdoor/heat source-unit side (main pipe)

- Restrictions for installing the joint described here only apply to CMY-Y202S-G2 and CMY-Y302S-G2 in the gas line.
- CMY-Y202S-G2 and CMY-Y302S-G2 in the gas line must be installed horizontally (see figure above) or with the branched pipes facing up.
- If the size of the refrigerant pipe that is selected by following the instructions under “Piping Design” section does not match the size of the joint, use a reducer to connect them. A reducer is included in the kit.

■ **Header**

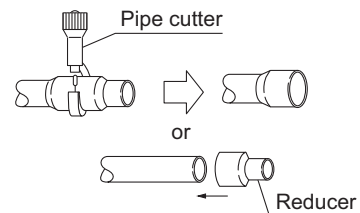
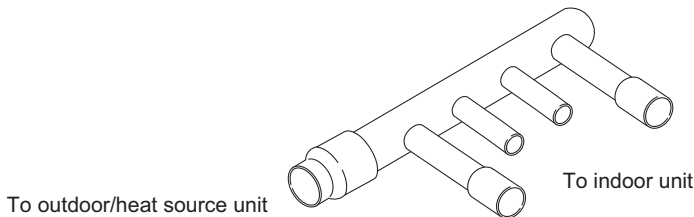

- No restrictions apply to the installation of the header.
- If the size of the refrigerant pipe that is selected by following the instructions under “Piping Design” section does not match the size of the header, cut the pipe to an appropriate size using a pipe cutter, or use a reducer to connect them.
- If the number of header branches exceeds the number of pipes to be connected, cap the unused header branches. Caps are included in the kit.

[2] Branches on the outdoor/heat source-unit side

Note. Refer to the figure below for the installation position of the twinning pipe.

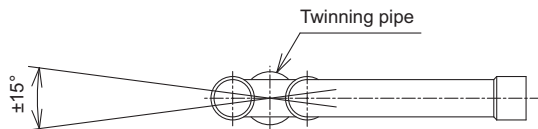

Slope of the twinning pipes are at an angle within $\pm 15^\circ$ to the horizontal plane.

- **Inclination of the twinning pipes**
The inclination of the twinning pipes must be $\pm 15^\circ$ or less against the horizontal plane. Excessive inclination of the twinning pipes may damage the unit.
- **Minimum length of the straight section of the pipe before the twinning pipes**
Always use the pipes supplied in the twinning pipe kit, and make sure the straight section of the pipe immediately before it connects to the twinning pipe is at least 500 mm (19-11/16 in.). Failure to do so may damage the unit.

12-2. Piping Design

Rule for piping size selection

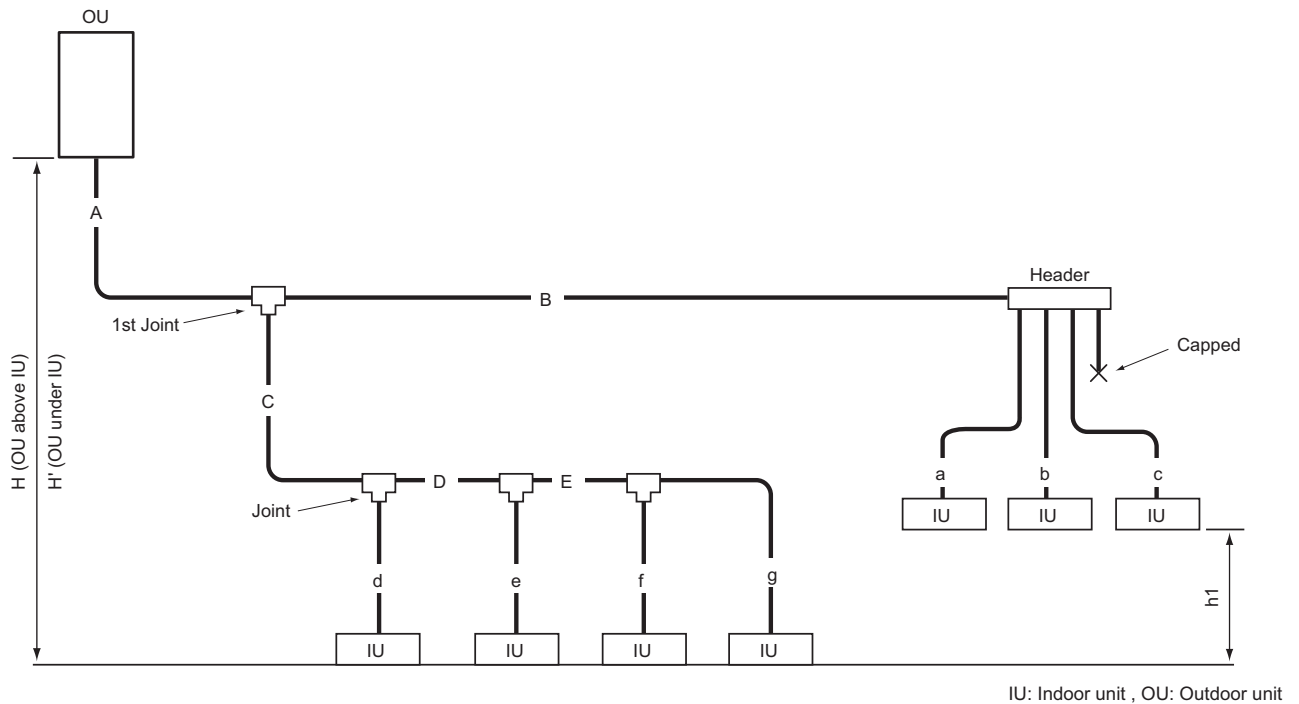

1. Selecting joints

Select joints from Table 4-1 [Selection criteria for joints] based on the total capacity of indoor units on the downstream side.

When selecting the first joint for the system to which the outdoor unit listed in Table 4-2 [See the table below for the first joint of the outdoor unit described below.] is connected, select the first joint from Table 4-2.

2. Selecting headers

Select headers from Table 5 [Header selection rule] based on the number of indoor units to be connected.

Refer to Table 5, which shows the total capacity limits, for the indoor units to be connected on the downstream side.

When connecting a header directly to the outdoor unit, select the header by referring to the notes in Table 5.

*The piping cannot be branched on the downstream of the header.

3. Selecting refrigerant pipe sizes

(1) Between outdoor unit and the 1st joint [A]

Select the appropriate size pipes for the selected outdoor unit from Table 1 [Piping "A" size selection rule].

(2) Between joints [B, C, D, and E]

Select the appropriate size pipes from Table 2 [Piping "B", "C", "D", ... size selection rule] based on the total capacity of indoor units on the downstream side.

(3) Between joints and indoor units [a, b, c, d, e, f, and g]

Select the appropriate size pipes from Table 3 [Piping "a", "b", "c", "d", ... size selection rule] based on the capacity of indoor units.

(4) After selecting the pipe sizes in accordance with steps (1) through (3) above, if the size of the pipes on the downstream is larger than that on the upstream, it is not necessary to be bigger than the upstream one.

(5) If any of the following applies to the selection made in Item 3-(1)-(4) above, reselect the pipe size.

(Not applicable to some models)

(a) If the length of the pipe to any indoor unit from the first joint exceeds 40 m [131 ft.], use one size larger liquid pipe after the joint that is located before the point where the pipe length exceeds 40 m [131 ft.].

(b) Set indoor unit(s) which is vertically closer to the outdoor unit as "base unit(s)".

Only the indoor units that have a height difference of more than 15 m [49 ft.] from base unit will be termed "Target units".

Use one size larger liquid pipe from the target units to the joint prior to which 15 m [49 ft.] height difference has exceeded.

(Not applicable to the liquid pipes whose sizes were increased under item (5)-(a)).

(6) Calculate the amount of refrigerant to be added based on the pipe sizes selected in Items 1 through 3-(5) above, and make sure that the total amount of the initial charge and the additional charge combined will not exceed the maximum allowable refrigerant charge amount. If this amount exceeds the maximum allowable amount, redesign the system (i.e., piping length) so that the total refrigerant charge will not exceed the maximum allowable amount.

12-2-1. PUHY-P200-500YNW-A1 Piping

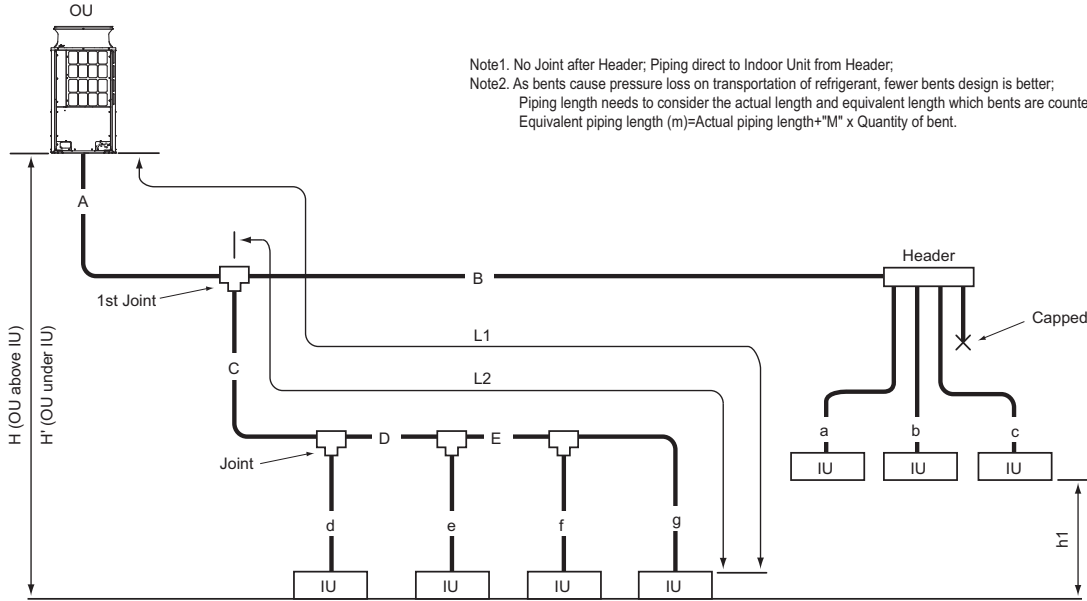

Fig. 12-2-1A Piping scheme

IU : Indoor unit , OU : Outdoor unit

Note1. No Joint after Header; Piping direct to Indoor Unit from Header;
 Note2. As bents cause pressure loss on transportation of refrigerant, fewer bents design is better;
 Piping length needs to consider the actual length and equivalent length which bents are counted.
 Equivalent piping length (m)=Actual piping length+“M” x Quantity of bent.

| Piping length | | (m [ft.]) | | Bent equivalent length "M" | |
|----------------------------------------|-------------------------|--------------|------------------------|----------------------------|-----------------------|
| Item | Piping in the figure | Max. length | Max. equivalent length | Outdoor unit model | M (m/bent [ft./bent]) |
| Total piping length | A+B+C+D+E+a+b+c+d+e+f+g | 1000 [3280'] | - | PUHY-P200YNW-A1 | 0.42 [1.38] |
| Farthest IU from OU (L1) | A+C+D+E+g / A+B+c | 165 [541'] | 190 [623'] | PUHY-P250YNW-A1 | 0.42 [1.38] |
| Farthest IU from first Joint (L2) | C+D+E+g / B+c | 40 [131'] *3 | 40 [131'] | PUHY-P300YNW-A1 | 0.47 [1.54] |
| Height between OU and IU (OU above IU) | H | 50 [164'] *1 | - | PUHY-P350YNW-A1 | 0.47 [1.54] |
| Height between OU and IU (OU under IU) | H' | 40 [131'] *2 | - | PUHY-P400YNW-A1 | 0.50 [1.64] |
| Height between IU and IU | h1 | 15 [49'] *4 | - | PUHY-P450YNW-A1 | 0.50 [1.64] |
| | | | | PUHY-P500YNW-A1 | 0.50 [1.64] |

OU: Outdoor Unit, IU: Indoor Unit

- *1 90 m is available depending on the model and installation conditions. For more detailed information, contact your local distributor.
- *2 60 m is available depending on the model and installation conditions. For more detailed information, contact your local distributor.
- *3 90 m is available. When the piping length exceeds 40 m, use one size larger liquid pipe starting with the section of piping where 40 m is exceeded and all piping after that point. In the figure above, if the piping labeled "E" exceeds 40 m (but does not exceed 90 m), increase the size of the liquid piping labeled E, f, and g by one size.
- *4 30 m is available. If the height difference between indoor units exceeds 15 m (but does not exceed 30 m), use one-size larger pipes for indoor unit liquid pipes. In the figure above, if "h1" exceeds 15 m, increase the size of the liquid piping labeled d, e, f, and g by one size.

Table 1 Piping "A" size selection rule (mm [in.])

| Outdoor unit | Pipe(Liquid) | Pipe(Gas) |
|-----------------|-----------------|-----------------|
| PUHY-P200YNW-A1 | ø9.52 [3/8"] | ø22.20 [7/8"] |
| PUHY-P250YNW-A1 | ø9.52 [3/8"] *1 | ø22.20 [7/8"] |
| PUHY-P300YNW-A1 | ø9.52 [3/8"] *2 | ø22.20 [7/8"] |
| PUHY-P350YNW-A1 | ø12.70 [1/2"] | ø28.58 [1-1/8"] |
| PUHY-P400YNW-A1 | ø12.70 [1/2"] | ø28.58 [1-1/8"] |
| PUHY-P450YNW-A1 | ø15.88 [5/8"] | ø28.58 [1-1/8"] |
| PUHY-P500YNW-A1 | ø15.88 [5/8"] | ø28.58 [1-1/8"] |

- *1. L1>=90m [295ft.], ø12.70mm [1/2in.]; L1<90m [295ft.], ø9.52mm [3/8in.]
- *2. L1>=40m [131ft.], ø12.70mm [1/2in.]; L1<40m [131ft.], ø9.52mm [3/8in.]

Table 4-1 Selection criteria for joints

| Total down-stream Indoor capacity | Joint |
|-----------------------------------|---------------|
| ~ P200 | CMY-Y102SS-G2 |
| P201 ~ P400 | CMY-Y102LS-G2 |
| P401 ~ P650 | CMY-Y202S-G2 |
| P651 ~ | CMY-Y302S-G2 |

* Concerning detailed usage of Joint parts, refer to its Installation Manual.

Table 4-2
 See the table below for the first joint of the outdoor unit described below.

| Outdoor unit model | Joint model |
|--------------------|---------------|
| P200 to P400 | CMY-Y102LS-G2 |
| P450, P500 | CMY-Y202S-G2 |

Table 2 Piping "B", "C", "D", "E" size selection rule (mm [in.])

| Total down-stream Indoor capacity | Pipe(Liquid) | Pipe(Gas) |
|-----------------------------------|---------------|-----------------|
| ~ P140 | ø9.52 [3/8"] | ø15.88 [5/8"] |
| P141 ~ P200 | ø9.52 [3/8"] | ø19.05 [3/4"] |
| P201 ~ P300 | ø9.52 [3/8"] | ø22.20 [7/8"] |
| P301 ~ P400 | ø12.70 [1/2"] | ø28.58 [1-1/8"] |
| P401 ~ P650 | ø15.88 [5/8"] | ø28.58 [1-1/8"] |
| P651 ~ P800 | ø19.05 [3/4"] | ø34.93 [1-3/8"] |
| P801 ~ | ø19.05 [3/4"] | ø41.28 [1-5/8"] |

Table 5 Header selection rule

| | 4-branch Header | 8-branch Header | 10-branch Header |
|-----------------------------------|-----------------|-----------------|------------------|
| | CMY-Y104-G | CMY-Y108-G | CMY-Y1010-G |
| Total down-stream Indoor capacity | <=P200 | <=P400 | <=P650 |

- * CMY-Y104-G can directly connect PUHY-P200YNW-A1, but can NOT directly connect PUHY-P250YNW-A1 or above;
- * CMY-Y108-G can directly connect PUHY-P200-450Y(S)NW-A1, but can NOT directly connect PUHY-P500Y(S)NW-A1 or above;
- * CMY-Y1010-G can directly connect PUHY-P200-600Y(S)NW-A1;
- * CMY-Y104-G can NOT connect P200, P250 Indoor, but CMY-Y108, Y1010-G can do;
- * Concerning detailed usage of Header parts, refer to its Installation Manual.

Table 3 Piping "a", "b", "c", "d", "e", "f", "g" size selection rule (mm [in.])

| Indoor Unit size | Pipe(Liquid) | Pipe(Gas) |
|------------------------------------------------|--------------|---------------|
| P10, P15, P20, P25, P32, P40, P50, GUF-50RD(H) | ø6.35 [1/4"] | ø12.70 [1/2"] |
| P63, P71, P80, P100, P125, P140, GUF-100RD(H) | ø9.52 [3/8"] | ø15.88 [5/8"] |
| P200 | ø9.52 [3/8"] | ø19.05 [3/4"] |
| P250 | ø9.52 [3/8"] | ø22.20 [7/8"] |

- Note3. Indoor capacity is described as its model size; For example, PEFY-P32VMA-E, its capacity is P32;
- Note4. Total down-stream Indoor capacity is the summary of the model size of Indoors downstream. For example, PEFY-P25VMA-E+PEFY-P32VMA-E: Total Indoor capacity=P25+P32=P57
- Note5. Piping sized determined by the Total down-stream indoor capacity is NOT necessary to be bigger than the up-stream one. i.e. A>=B; A>C>=D

12-2-2. PUHY-P400-900YSNW-A1 Piping

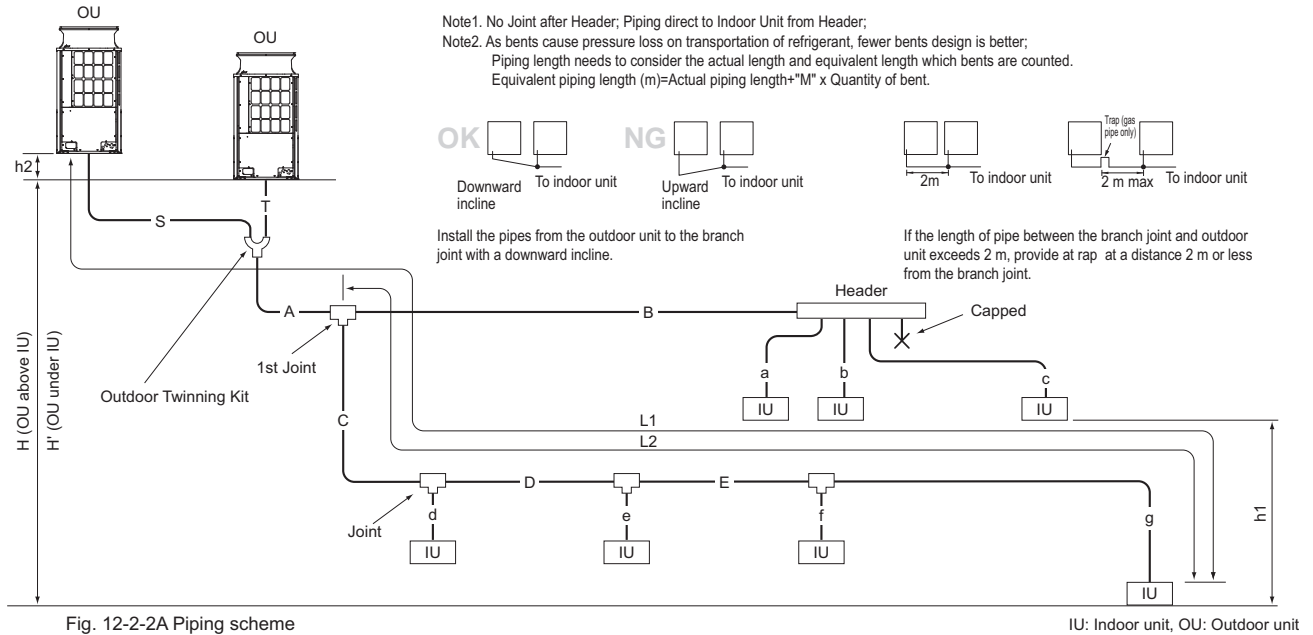

Fig. 12-2-2A Piping scheme

| Piping length | | (m [ft.]) | | Bent equivalent length "M" | |
|----------------------------------------|-----------------------------|--------------|------------------------|----------------------------|-----------------------|
| Item | Piping in the figure | Max. length | Max. equivalent length | Outdoor unit model | M (m/bent [ft./bent]) |
| Total piping length | S+T+A+B+C+D+E+a+b+c+d+e+f+g | 1000 [3280'] | - | PUHY-P400YSNW-A1 | 0.50 [1.64] |
| Distance between OU and OU | S+T | 10[32'] | - | PUHY-P450YSNW-A1 | 0.50 [1.64] |
| Height between OU and OU | h2 | 0.1[0.3'] | - | PUHY-P500YSNW-A1 | 0.50 [1.64] |
| Farthest IU from OU (L1) | S(T)+A+C+D+E+g / S(T)+A+B+c | 165 [541'] | 190 [623'] | PUHY-P550YSNW-A1 | 0.50 [1.64] |
| Farthest IU from the first Joint (L2) | C+D+E+g / B+c | 40 [131'] *3 | 40 [131'] | PUHY-P600YSNW-A1 | 0.50 [1.64] |
| Height between OU and IU (OU above IU) | H | 50 [164'] *1 | - | PUHY-P650YSNW-A1 | 0.50 [1.64] |
| Height between OU and IU (OU under IU) | H' | 40 [131'] *2 | - | PUHY-P700YSNW-A1 | 0.70 [2.29] |
| Height between IU and IU | h1 | 15 [49'] *4 | - | PUHY-P750YSNW-A1 | 0.70 [2.29] |
| | | | | PUHY-P800YSNW-A1 | 0.70 [2.29] |
| | | | | PUHY-P850YSNW-A1 | 0.80 [2.62] |
| | | | | PUHY-P900YSNW-A1 | 0.80 [2.62] |

OU: Outdoor Unit, IU: Indoor Unit

*1 90 m is available depending on the model and installation conditions. For more detailed information, contact your local distributor.

*2 60 m is available depending on the model and installation conditions. For more detailed information, contact your local distributor.

*3 90 m is available. When the piping length exceeds 40 m, use one size larger liquid pipe starting with the section of piping where 40 m is exceeded and all piping after that point.

In the figure above, if the piping labeled "E" exceeds 40 m (but does not exceed 90 m), increase the size of the liquid piping labeled E, f, and g by one size.

*4 30 m is available. If the height difference between indoor units exceeds 15 m (but does not exceed 30 m), use one-size larger pipes for indoor unit liquid pipes.

In the figure above, if "h1" exceeds 15 m, increase the size of the liquid piping labeled g by one size.

Table 1 Piping "A" size selection rule (mm [in.])

| Outdoor unit | Twinning kit | Pipe(Liquid) | Pipe(Gas) |
|----------------------|--------------|--------------|----------------|
| PUHY-P400YSNW-A1 | CMY-Y100VBK3 | ø12.7[1/2"] | ø28.58[1-1/8"] |
| PUHY-P450-650YSNW-A1 | CMY-Y100VBK3 | ø15.88[5/8"] | ø28.58[1-1/8"] |
| PUHY-P700-800YSNW-A1 | CMY-Y200VBK2 | ø19.05[3/4"] | ø34.93[1-3/8"] |
| PUHY-P850-900YSNW-A1 | CMY-Y200VBK2 | ø19.05[3/4"] | ø41.28[1-5/8"] |

For Piping size "S", "T", please refer to specification of the Twinning kit CMY-Y100VBK3 or CMY-Y200VBK2 at the Outdoor unit's external drawing.

Table 2 Piping "B", "C", "D", "E" size selection rule (mm [in.])

| Total down-stream Indoor capacity | Pipe(Liquid) | Pipe(Gas) |
|-----------------------------------|---------------|-----------------|
| ~ P140 | ø9.52 [3/8"] | ø15.88 [5/8"] |
| P141 ~ P200 | ø9.52 [3/8"] | ø19.05 [3/4"] |
| P201 ~ P300 | ø9.52 [3/8"] | ø22.20 [7/8"] |
| P301 ~ P400 | ø12.70 [1/2"] | ø28.58 [1-1/8"] |
| P401 ~ P650 | ø15.88 [5/8"] | ø28.58 [1-1/8"] |
| P651 ~ P800 | ø19.05 [3/4"] | ø34.93 [1-3/8"] |
| P801 ~ | ø19.05 [3/4"] | ø41.28 [1-5/8"] |

Table 3 Piping "a", "b", "c", "d", "e", "f", "g" size selection rule (mm [in.])

| Indoor Unit size | Pipe(Liquid) | Pipe(Gas) |
|------------------------------------------------|--------------|---------------|
| P10, P15, P20, P25, P32, P40, P50, GUF-50RD(H) | ø6.35 [1/4"] | ø12.70 [1/2"] |
| P63, P71, P80, P100, P125, P140, GUF-100RD(H) | ø9.52 [3/8"] | ø15.88 [5/8"] |
| P200 | ø9.52 [3/8"] | ø19.05 [3/4"] |
| P250 | ø9.52 [3/8"] | ø22.20 [7/8"] |

Table 4-1 Selection criteria for joints

| Total down-stream Indoor capacity | Joint |
|-----------------------------------|---------------|
| ~ P200 | CMY-Y102SS-G2 |
| P201 ~ P400 | CMY-Y102LS-G2 |
| P401 ~ P650 | CMY-Y202S-G2 |
| P651 ~ | CMY-Y302S-G2 |

*Concerning detailed usage of Joint parts, refer to its Installation Manual.

*The total capacity of the units in the downstream of the branch joint on at least one of the piping lines that are connected to the branch joint should be 650 or below.

If the total capacity of the units in the downstream of the branch joints on both lines is 650 or above use two branch joints (CMY-Y302S-G2).

Table 4-2 See the table below for the first joint of the outdoor unit described below.

| Outdoor unit model | Joint model |
|--------------------|---------------|
| P400 | CMY-Y102LS-G2 |
| P450 to P650 | CMY-Y202S-G2 |
| P700 to P900 | CMY-Y302S-G2 |

Table 5 Header selection rule

| | 4-branch Header | 8-branch Header | 10-branch Header |
|-----------------------------------|-----------------|-----------------|------------------|
| | CMY-Y104-G | CMY-Y108-G | CMY-Y1010-G |
| Total down-stream Indoor capacity | <=P200 | <=P400 | <=P650 |

* CMY-Y104-G can directly connect PUHY-P200YWNW-A1, but can NOT directly connect PUHY-P250YWNW-A1 or above;

* CMY-Y108-G can directly connect PUHY-P200-450Y(S)NW-A1, but can NOT directly connect PUHY-P500Y(S)NW-A1 or above;

* CMY-Y1010-G can directly connect PUHY-P200-600Y(S)NW-A1;

* CMY-Y104-G can NOT connect P200, P250 Indoor, but CMY-Y108, Y1010-G can do;

* Concerning detailed usage of Header parts, refer to its Installation Manual.

Note3. Indoor capacity is described as its model size;

For example, PEFY-P32VMA-E, its capacity is P32;

Note4. Total down-stream Indoor capacity is the summary of the model size of Indoors downstream.

For example, PEFY-P25VMA-E+PEFY-P32VMA-E: Total Indoor capacity=P25+P32=P57

Note5. Piping sized determined by the Total down-stream indoor capacity is NOT necessary

to be bigger than the up-stream one.

i.e. A>=B; A>C>=D

PUHY-P-Y(S)NW-A1

12-2-3. PUHY-P950-1350YSNW-A1 Piping

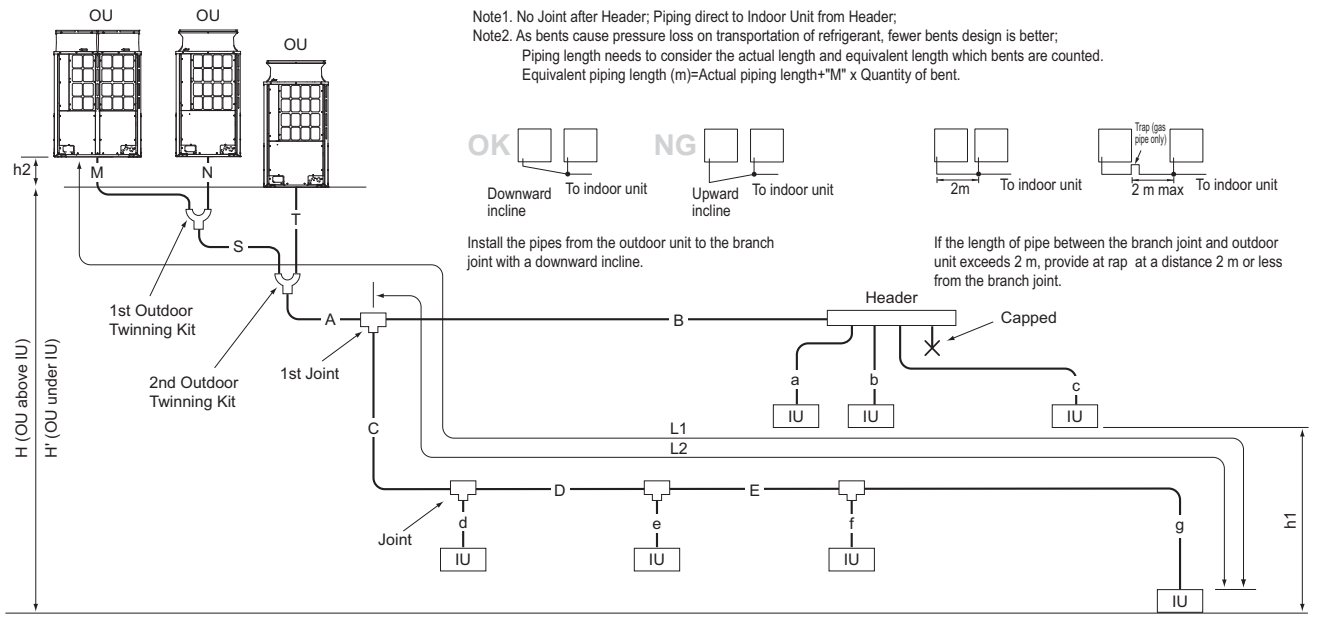

Fig. 12-2-3A Piping scheme

IU : Indoor unit , OU : Outdoor unit

| Piping length | | (m [ft.]) | | Bent equivalent length "M" | |
|----------------------------------------|---------------------------------|-------------|------------------------|----------------------------|-----------------------|
| Item | Piping in the figure | Max. length | Max. equivalent length | Outdoor unit model | M (m/bent [ft./bent]) |
| Total piping length | S+T+M+N+A+B+C+D+E+a+b+c+d+e+f+g | 1000[3280]* | - | PUHY-P950YSNW-A1 | 0.80 [2.62] |
| Distance between OU and OU | M+N+S+T | 10[32] | - | PUHY-P1000YSNW-A1 | 0.80 [2.62] |
| Height between OU and OU | h2 | 0.1[0.3] | - | PUHY-P1050YSNW-A1 | 0.80 [2.62] |
| Farthest IU from OU (L1) | M(N)+S+A+C+D+E+g / M(N)+S+A+B+c | 165[541]* | 190[623]* | PUHY-P1100YSNW-A1 | 0.80 [2.62] |
| Farthest IU from the first Joint (L2) | C+D+E+g / B+c | 40[131]*3 | 40[131]* | PUHY-P1150YSNW-A1 | 0.80 [2.62] |
| Height between OU and IU (OU above IU) | H | 50[164]*1 | - | PUHY-P1200YSNW-A1 | 0.80 [2.62] |
| Height between OU and IU (OU under IU) | H' | 40[131]*2 | - | PUHY-P1250YSNW-A1 | 0.80 [2.62] |
| Height between IU and IU | h1 | 15[49]*4 | - | PUHY-P1300YSNW-A1 | 0.80 [2.62] |
| | | | | PUHY-P1350YSNW-A1 | 0.80 [2.62] |

OU: Outdoor Unit, IU: Indoor Unit
 *1 90 m is available depending on the model and installation conditions. For more detailed information, contact your local distributor.
 *2 60 m is available depending on the model and installation conditions. For more detailed information, contact your local distributor.
 *3 90 m is available. When the piping length exceeds 40 m, use one size larger liquid pipe starting with the section of piping where 40 m is exceeded and all piping after that point.
 In the figure above, if the piping labeled "E" exceeds 40 m (but does not exceed 90 m), increase the size of the liquid piping labeled E, f, and g by one size.
 *4 30 m is available. If the height difference between indoor units exceeds 15 m (but does not exceed 30 m), use one-size larger pipes for indoor unit liquid pipes.
 In the figure above, if "h1" exceeds 15 m, increase the size of the liquid piping labeled g by one size.

Table 1 Piping "A" size selection rule (mm [in.])

| Outdoor unit | Twinning kit | Pipe(Liquid) | Pipe(Gas) |
|-----------------------|--------------|--------------|----------------|
| PUHY-P950-1350YSNW-A1 | CMY-Y300VBK3 | ø19.05[3/4"] | ø41.28[1-5/8"] |

For Piping size "M", "N", "S", "T", please refer to specification of the Twinning kit CMY-Y300VBK3 at the Outdoor unit's external drawing.

Table 4-1 Selection criteria for joints

| Total down-stream Indoor capacity | Joint |
|-----------------------------------|---------------|
| ~ P200 | CMY-Y102SS-G2 |
| P201 ~ P400 | CMY-Y102LS-G2 |
| P401 ~ P650 | CMY-Y202S-G2 |
| P651 ~ | CMY-Y302S-G2 |

Table 2 Piping "B", "C", "D", "E" size selection rule (mm [in.])

| Total down-stream Indoor capacity | Pipe(Liquid) | Pipe(Gas) |
|-----------------------------------|---------------|-----------------|
| ~ P140 | ø9.52 [3/8"] | ø15.88 [5/8"] |
| P141 ~ P200 | ø9.52 [3/8"] | ø19.05 [3/4"] |
| P201 ~ P300 | ø9.52 [3/8"] | ø22.20 [7/8"] |
| P301 ~ P400 | ø12.70 [1/2"] | ø28.58 [1-1/8"] |
| P401 ~ P650 | ø15.88 [5/8"] | ø28.58 [1-1/8"] |
| P651 ~ P800 | ø19.05 [3/4"] | ø34.93 [1-3/8"] |
| P801 ~ | ø19.05 [3/4"] | ø41.28 [1-5/8"] |

*The total capacity of the units in the downstream of the branch joint on at least one of the piping lines that are connected to the branch joint should be 650 or below.
 If the total capacity of the units in the downstream of the branch joints on both lines is 650 or above use two branch joints (CMY-Y302S-G2).
 *Concerning detailed usage of Joint parts, refer to its Installation Manual.

Table 4-2 See the table below for the first joint of the outdoor unit described below.

| Outdoor unit model | Joint model |
|--------------------|--------------|
| P950 to P1350 | CMY-Y302S-G2 |

Table 3 Piping "a", "b", "c", "d", "e", "f", "g" size selection rule (mm [in.])

| Indoor Unit size | Pipe(Liquid) | Pipe(Gas) |
|------------------------------------------------|--------------|---------------|
| P10, P15, P20, P25, P32, P40, P50, GUF-50RD(H) | ø6.35 [1/4"] | ø12.70 [1/2"] |
| P63, P71, P80, P100, P125, P140, GUF-100RD(H) | ø9.52 [3/8"] | ø15.88 [5/8"] |
| P200 | ø9.52 [3/8"] | ø19.05 [3/4"] |
| P250 | ø9.52 [3/8"] | ø22.20 [7/8"] |

Table 5 Header selection rule

| | 4-branch Header | 8-branch Header | 10-branch Header |
|-----------------------------------|-----------------|-----------------|------------------|
| | CMY-Y104-G | CMY-Y108-G | CMY-Y1010-G |
| Total down-stream Indoor capacity | <=P200 | <=P400 | <=P650 |

* CMY-Y104-G can directly connect PUHY-P200YVMA-A1, but can NOT directly connect PUHY-P250YVMA-A1 or above;
 * CMY-Y108-G can directly connect PUHY-P200-450Y(S)NW-A1, but can NOT directly connect PUHY-P500Y(S)NW-A1 or above;
 * CMY-Y1010-G can directly connect, PUHY-P200-600Y(S)NW-A1;
 * CMY-Y104-G can NOT connect P200, P250 Indoor, but CMY-Y108, Y1010-G can do;
 * Concerning detailed usage of Header parts, refer to its Installation Manual.

Note3. Indoor capacity is described as its model size;
 For example, PEFY-P32VMA-E, its capacity is P32;
 Note4. Total down-stream Indoor capacity is the summary of the model size of Indoors downstream.
 For example, PEFY-P25VMA-E+PEFY-P32VMA-E: Total Indoor capacity=P25+P32=P57
 Note5. Piping sized determined by the Total down-stream indoor capacity is NOT necessary to be bigger than the up-stream one.
 i.e. A>=B; A>=C>=D

12-3. Refrigerant charging calculation

At the time of shipping, the outdoor unit is charged with the refrigerant. As this charge does not include the amount needed for extended piping, additional charging for each refrigerant line will be required on site. In order that future servicing may be properly provided, always keep a record of the size and length of each refrigerant line and the amount of additional charge by writing it in the space provided on the outdoor unit.

(1) Calculation of additional refrigerant charge

- Calculate the amount of additional charge based on the length of the piping extension and the size of the refrigerant line.
- Use the table below as a guide to calculate the amount of additional charging and charge the system accordingly.
- If the calculation results in a fraction of less than 0.1kg, round up to the next 0.1kg. For example, if the result of the calculation was 12.33kg, round the result up to 12.4kg.
- * When connecting PEFY-P20VMA3-E units, add 0.54 kg of refrigerant for each of these units.
- * When connecting PEFY-P25/32/40VMA3-E units, add 0.74 kg of refrigerant for each of these units.
- * When connecting PEFY-P50/63/71/80/100/125VMA3-E units, add 1.16 kg of refrigerant for each of these units.
- * When connecting PEFY-P50/63/71/80/100VMHS2-E units, add 2.7 kg of refrigerant for each of these units.
- * When connecting PEFY-M50/63/71/80/100/125VMA2-A units, add 1.45 kg of refrigerant for each of these units.
- * When connecting LEV kit (PAC-LV11M-J), additional refrigerant charge may be required. Contact your local distributor for details.
- * When connecting PLFY-EP50/63/80VEM-E units, add 0.5 kg of refrigerant for each of these units.

<Additional Charge>

Units "m" and "kg"

<Formula>

- When the piping length from the outdoor unit to the farthest indoor unit is 30.5 m (100 ft) or shorter

$$\text{Amount of additional charge (kg)} = \left[\begin{matrix} \text{ø19.05 total length} \\ \times 0.29 \text{ (kg/m)} \end{matrix} \right] + \left[\begin{matrix} \text{ø15.88 total length} \\ \times 0.2 \text{ (kg/m)} \end{matrix} \right] + \left[\begin{matrix} \text{ø12.7 total length} \\ \times 0.12 \text{ (kg/m)} \end{matrix} \right] + \left[\begin{matrix} \text{ø9.52 total length} \\ \times 0.06 \text{ (kg/m)} \end{matrix} \right] + \left[\begin{matrix} \text{ø6.35 total length} \\ \times 0.024 \text{ (kg/m)} \end{matrix} \right]$$

| Outdoor unit model | Amount (kg) | Total capacity of connected indoor units | Amount (kg) |
|--------------------|-------------|------------------------------------------|-------------|
| P200 | 0 | 80 or below | 2.0 |
| P250 | 0 | 81 to 160 | 2.5 |
| P300 | 0 | 161 to 330 | 3.0 |
| P350 | 0 | 331 to 390 | 3.5 |
| P400 | 0 | 391 to 480 | 4.5 |
| P450 | 0 | 481 to 630 | 5.0 |
| P500 | 0 | 631 to 710 | 6.0 |
| | | 711 to 800 | 8.0 |
| | | 801 to 890 | 9.0 |
| | | 891 to 1070 | 10.0 |
| | | 1071 to 1250 | 12.0 |
| | | 1251 or above | 14.0 |

- When the piping length from the outdoor unit to the farthest indoor unit is longer than 30.5 m (100 ft)

$$\text{Amount of additional charge (kg)} = \left[\begin{matrix} \text{ø19.05 total length} \\ \times 0.26 \text{ (kg/m)} \end{matrix} \right] + \left[\begin{matrix} \text{ø15.88 total length} \\ \times 0.18 \text{ (kg/m)} \end{matrix} \right] + \left[\begin{matrix} \text{ø12.7 total length} \\ \times 0.11 \text{ (kg/m)} \end{matrix} \right] + \left[\begin{matrix} \text{ø9.52 total length} \\ \times 0.054 \text{ (kg/m)} \end{matrix} \right] + \left[\begin{matrix} \text{ø6.35 total length} \\ \times 0.021 \text{ (kg/m)} \end{matrix} \right]$$

| Outdoor unit model | Amount (kg) | Total capacity of connected indoor units | Amount (kg) |
|--------------------|-------------|------------------------------------------|-------------|
| P200 | 0 | 80 or below | 2.0 |
| P250 | 0 | 81 to 160 | 2.5 |
| P300 | 0 | 161 to 330 | 3.0 |
| P350 | 0 | 331 to 390 | 3.5 |
| P400 | 0 | 391 to 480 | 4.5 |
| P450 | 0 | 481 to 630 | 5.0 |
| P500 | 0 | 631 to 710 | 6.0 |
| | | 711 to 800 | 8.0 |
| | | 801 to 890 | 9.0 |
| | | 891 to 1070 | 10.0 |
| | | 1071 to 1250 | 12.0 |
| | | 1251 or above | 14.0 |

Example: PUHY-P350YNW-A1

PUHY-P-Y(S)NW-A1

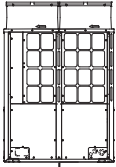

| | | | | | |
|-----------|------|----------|------|----------|------|
| Indoor 1: | P125 | A: ø12.7 | 40 m | a: ø9.52 | 10 m |
| 2: | P100 | B: ø9.52 | 10 m | b: ø9.52 | 5 m |
| 3: | P40 | C: ø9.52 | 15 m | c: ø6.35 | 10 m |
| 4: | P32 | D: ø9.52 | 10 m | d: ø9.52 | 10 m |
| 5: | P63 | e: ø12.7 | 10 m | | |

The total length of liquid pipe of each size is as follows:
 ø12.7: A + e = 40 + 10 = 50 m
 ø9.52: B + C + D + a + b + d = 10 + 15 + 10 + 10 + 5 + 10 = 60 m
 ø6.35: c = 10 = 10 m

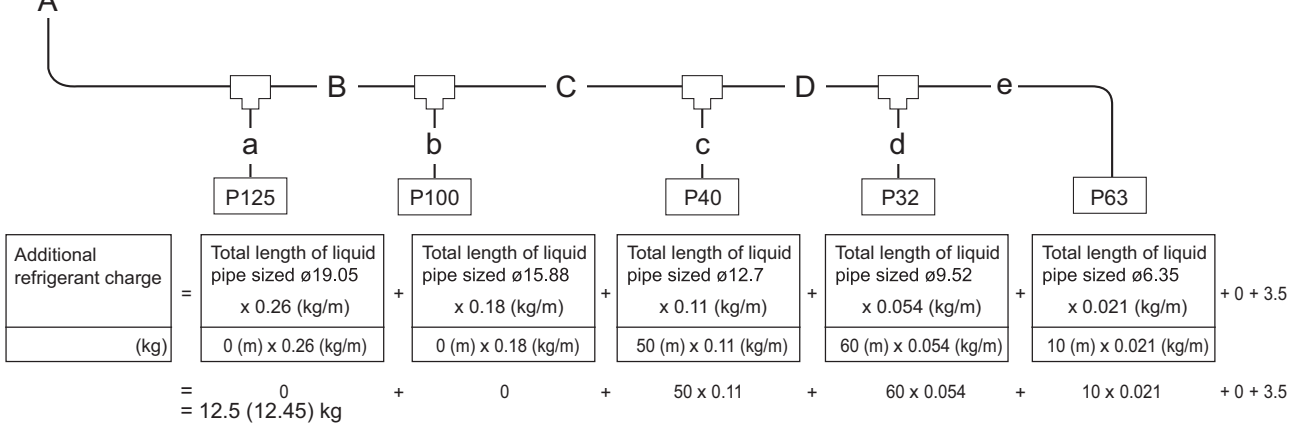

■ Amount of factory charged refrigerant

| Outdoor unit model | Charged amount |
|----------------------|----------------|
| P200 P250 P300 | 6.5kg |
| P350 P400 | 9.8kg |
| P450 P500 | 10.8kg |

■ Maximum refrigerant charge

There is a limit to the amount of refrigerant that can be charged into a unit. Regardless of the amount yielded by the formula above, observe the maximum refrigerant charge in the table below.

| Total index of the outdoor units | | | P200 YNW-A1 | P250 YNW-A1 | P300 YNW-A1 | P350 YNW-A1 | P400 YNW-A1 | P450 YNW-A1 | P500 YNW-A1 | P400 YSNW-A1 | P450 YSNW-A1 | P500 YSNW-A1 | P550 YSNW-A1 | P600 YSNW-A1 | P650 YSNW-A1 | P700 YSNW-A1 |
|----------------------------------|------------------|----|----------------|----------------|----------------|----------------|----------------|----------------|----------------|-----------------|-----------------|-----------------|-----------------|-----------------|-----------------|-----------------|
| Maximum refrigerant charge | Factory charged | kg | 6.5 | 6.5 | 6.5 | 9.8 | 9.8 | 10.8 | 10.8 | 13.0 | 13.0 | 13.0 | 13.0 | 13.0 | 16.3 | 19.6 |
| | Charged on site | kg | 15.9 | 22.9 | 23.4 | 24.0 | 24.4 | 32.2 | 33.1 | 32.0 | 32.0 | 32.9 | 34.7 | 34.7 | 35.2 | 44.8 |
| | Total for system | kg | 22.4 | 29.4 | 29.9 | 33.8 | 34.2 | 43.0 | 43.9 | 45.0 | 45.0 | 45.9 | 47.7 | 47.7 | 51.5 | 64.4 |

| Total index of the outdoor units | | | P750 YSNW-A1 | P800 YSNW-A1 | P850 YSNW-A1 | P900 YSNW-A1 | P950 YSNW-A1 | P1000 YSNW-A1 | P1050 YSNW-A1 | P1100 YSNW-A1 | P1150 YSNW-A1 | P1200 YSNW-A1 | P1250 YSNW-A1 | P1300 YSNW-A1 | P1350 YSNW-A1 |
|----------------------------------|------------------|----|-----------------|-----------------|-----------------|-----------------|-----------------|------------------|------------------|------------------|------------------|------------------|------------------|------------------|------------------|
| Maximum refrigerant charge | Factory charged | kg | 19.6 | 20.6 | 20.6 | 21.6 | 26.1 | 26.1 | 26.1 | 29.4 | 29.4 | 29.4 | 30.4 | 31.4 | 32.4 |
| | Charged on site | kg | 44.8 | 44.7 | 46.5 | 46.4 | 45.9 | 45.9 | 45.9 | 45.6 | 45.6 | 45.6 | 47.3 | 47.2 | 47.1 |
| | Total for system | kg | 64.4 | 65.3 | 67.1 | 68.0 | 72.0 | 72.0 | 72.0 | 75.0 | 75.0 | 75.0 | 77.7 | 78.6 | 79.5 |

13-1. Requirement on installation site

1. No direct thermal radiation to the unit.
2. No possibility of annoying the neighbors by the sound of the unit.

Valves and refrigerant flow on the outdoor unit may generate noise.

3. Avoid the sites where strong winds blow.
4. With strength to bear the weight of the unit.
5. Drain flow from the unit is cared at heating mode.
6. Enough space for installation and service as shown at 13-2.
7. Avoid the sites where acidic solutions or chemical sprays (sulfuric compounds) are used frequently.
8. The unit should be secure from combustible gas, oil, steam, chemical gas like acidic solution, sulfur gas and so on.

PUHY-P-Y(S)NW-A1

13-2. Spacing

In case of single installation

(1) When all walls are within their height limits*.

[mm (in)]

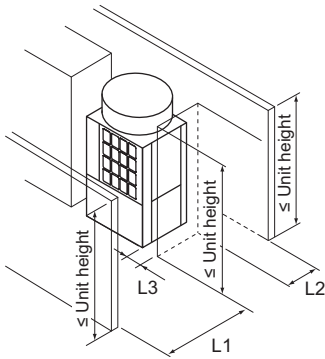

* Height limit

| | |
|-----------------------|----------------------------------------------------------|
| Front/Right/Left/Rear | Same height or lower than the overall height of the unit |
|-----------------------|----------------------------------------------------------|

| | Required minimum distance [mm (in)] | | |
|---------------------------------------------------------------|-------------------------------------|----------------|-----------------|
| | L1 (Front) | L2 (Rear) | L3 (Right/Left) |
| When the distance behind the unit (L2) needs to be small | 450 (17-3/4) | 100 (3-15/16) | 50 (2) |
| When the distance to the right or left (L3) needs to be small | 450 (17-3/4) | 300 (11-13/16) | 15 (5/8) |

(2) When one or more walls exceed their height limits*.

When the wall(s) at the front and/or the right/left exceed(s) their height limits

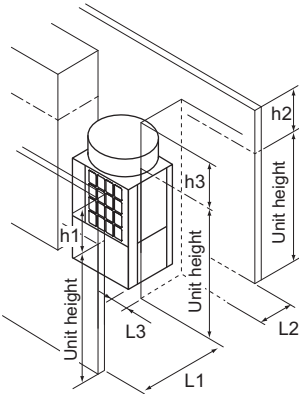

When the wall at the rear exceeds its height limit

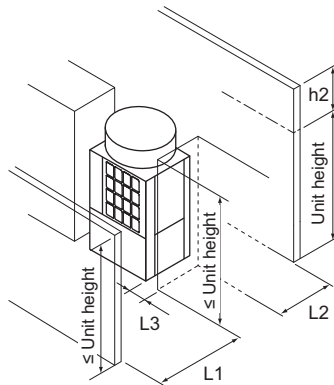

When all walls exceed their height limits

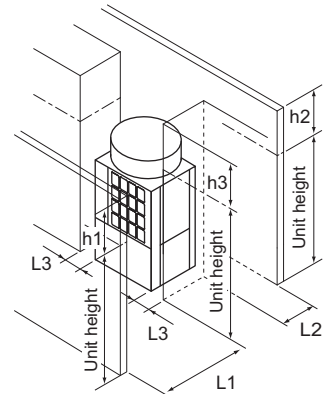

Add the dimension that exceeds the height limit (shown as "h1" through "h3" in the figures) to L1, L2, and L3 as shown in the table below.

| | Required minimum distance [mm (in)] | | |
|---------------------------------------------------------------|-------------------------------------|---------------------|-----------------|
| | L1 (Front) | L2 (Rear) | L3 (Right/Left) |
| When the distance behind the unit (L2) needs to be small | 450 (17-3/4) + h1 | 100 (3-15/16) + h2 | 50 (2) + h3 |
| When the distance to the right or left (L3) needs to be small | 450 (17-3/4) + h1 | 300 (11-13/16) + h2 | 15 (5/8) + h3 |

(3) When there are overhead obstacles

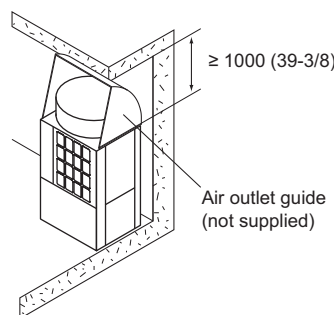
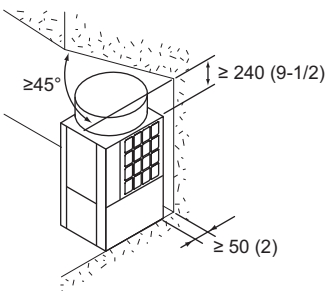

In case of collective installation and continuous installation

- When installing multiple units, make sure to take into consideration factors such as providing enough space for people to pass through, ample space between blocks of units, and sufficient space for airflow. (The areas marked with [A] in the figures below must be left open.)
- In the same way as with the single unit installation, add the dimension that exceeds the height limit (shown as "h1" through "h3" in the figures) to L1, L2, and L3 as shown in the tables below.
- If there are walls in the front and rear of the block of units, up to six units (three units for units P450 through P500) can be installed consecutively side by side, and a space of 1000 mm (39-3/8 in) or more must be left between each block of six units (three units for unit P500).

(1) Side-by-side installation

When the distances between the units (L4) need to be small

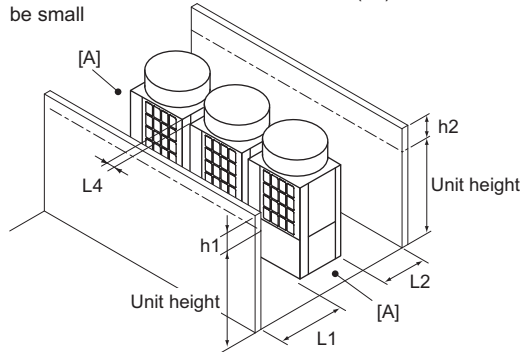

| Required minimum distance [mm (in)] | | |
|-------------------------------------|---------------------|--------------|
| L1 (Front) | L2 (Rear) | L4 (Between) |
| 450 (17-3/4) + h1 | 300 (11-13/16) + h2 | 30 (1-3/16) |

When the distance behind the block of units (L2) needs to be small

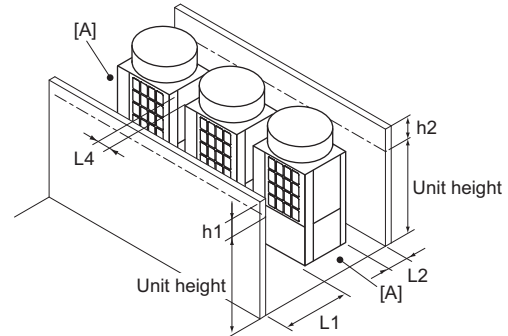

| Required minimum distance [mm (in)] | | |
|-------------------------------------|--------------------|---------------|
| L1 (Front) | L2 (Rear) | L4 (Between) |
| 450 (17-3/4) + h1 | 100 (3-15/16) + h2 | 100 (3-15/16) |

(2) Face-to-face installation

When there are walls in the front and rear of the block of units

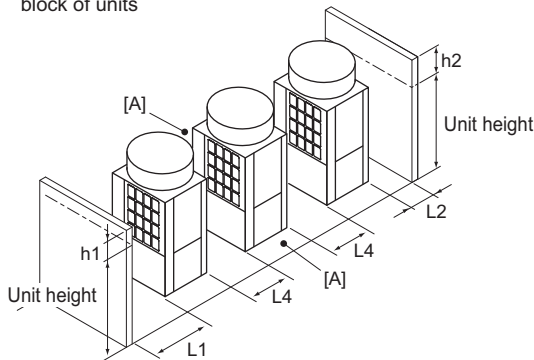

| Required minimum distance [mm (in)] | | |
|-------------------------------------|--------------------|--------------|
| L1 (Front) | L2 (Rear) | L4 (Between) |
| 450 (17-3/4) + h1 | 100 (3-15/16) + h2 | 450 (17-3/4) |

When there is a wall on either the right or left side of the block of units

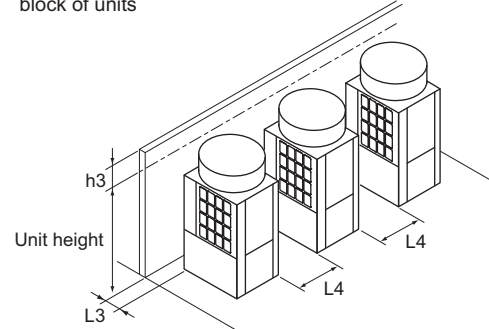

| Required minimum distance [mm (in)] | |
|-------------------------------------|--------------|
| L3 (Right/Left) | L4 (Between) |
| 15 (5/8) + h3 | 450 (17-3/4) |

(3) Combination of face-to-face and side-by-side installations

When there are walls in the front and rear of the block of units

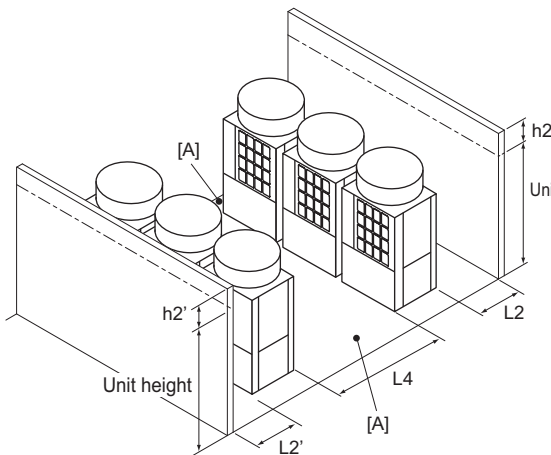

| Required minimum distance [mm (in)] | | |
|-------------------------------------|----------------------|---------------|
| L2 (Rear) | L2' (Rear) | L4 (Between) |
| 300 (11-13/16) + h2 | 300 (11-13/16) + h2' | 900 (35-7/16) |

When there are two walls in an L-shape

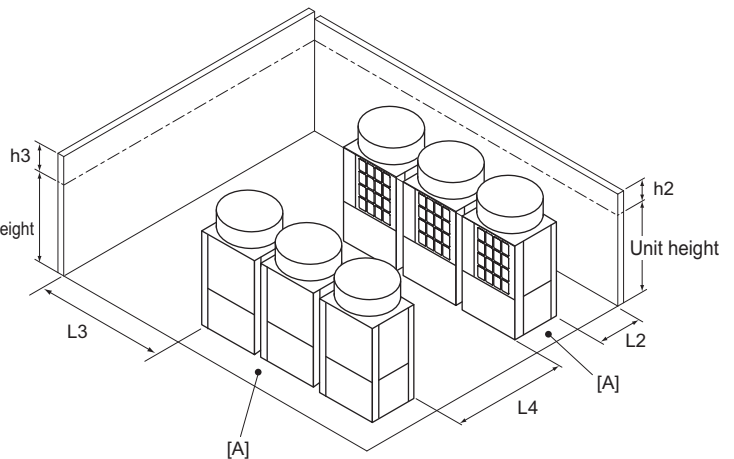

| Required minimum distance [mm (in)] | | |
|-------------------------------------|--------------------|---------------|
| L2 (Rear) | L3 (Right/Left) | L4 (Between) |
| 300 (11-13/16) + h2 | 1000 (39-3/8) + h3 | 900 (35-7/16) |

[A]: Leave open in two directions.

PUHY-P-Y(S)NW-A1

13-3. Piping direction

13-3-1. Lifting method

- Always use two slings to lift up the unit. Each sling must be at least 8 m (26 ft) long and must be able to support the weight of the unit.
- Put protective pads between slings and the unit where the slings touch the unit at the base to protect the unit from being scratched.
- Put 50 mm (2 in) or thicker protective pads between slings and the unit where the slings touch the unit at the top of the unit to protect the unit from being scratched and to avoid contact with the slings and the fan guard.
- Make sure that the angles between slings at the top are less than 40 degrees

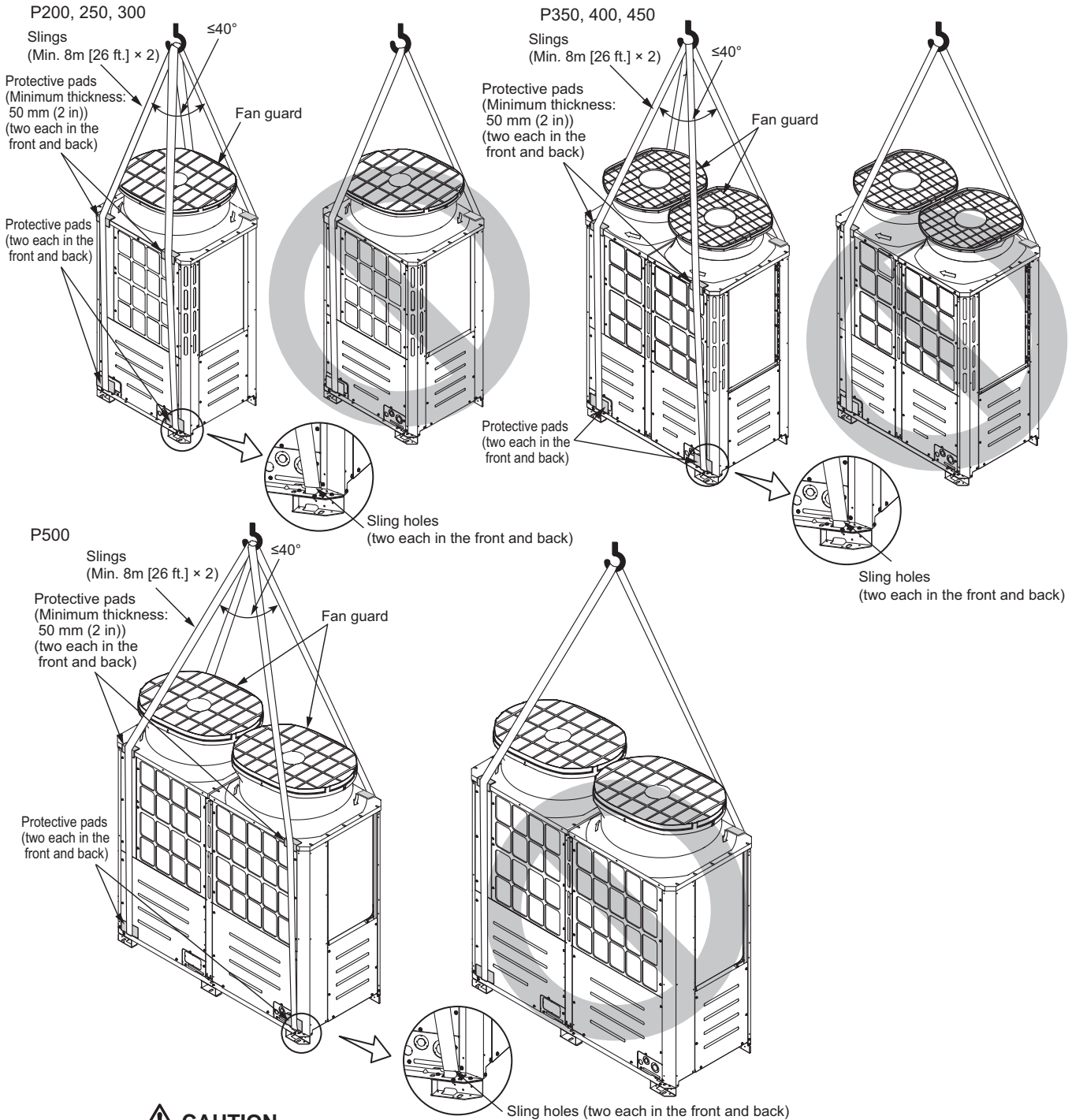

CAUTION

Exercise caution when transporting products.

- Products weighing more than 20 kg [45 LBS] should not be carried alone.
- Do not carry the product by the PPbands.
- To avoid the risk of injury, do not touch the heat exchanger fins.
- Plastic bags may pose a risk of choking hazard to children. Tear plastic bags into pieces before disposing of them.
- When lifting and transporting outdoor units with ropes, run the ropes through lifting hole at the unit base. Securely fix the unit so that the ropes will not slide off, and always lift the unit at four points to prevent the unit from falling.

13-3-2. Installation

- Secure the unit with anchor bolts as shown in the figure below so that the unit will not topple over with strong wind or during an earthquake.
- Install the unit on a durable base made of such materials as concrete or angle steel.
- Take appropriate anti-vibration measures (e.g., vibration damper pad, vibration isolation base) to keep vibrations and noise from being transmitted from the unit through walls and floors.
- When using a rubber cushion, install it so that the cushion covers the entire width of the unit leg.
- Install the unit in such a way that the corner of the angle bracket at the base of the unit shown in the figure below is securely supported.
- Install the anchor bolt in such a way that the top end of the anchor bolt do not stick out more than 30 mm [1-3/16 in.].
- This unit is not designed to be anchored with post-installation-type anchor bolts, although by adding fixing brackets anchoring with such type of anchor bolts becomes possible.

- (A) M10 anchor bolt (not supplied)
- (B) (Incorrect installation) The corner section is not securely received.
- (C) Fixing bracket for post-installed anchor bolts (not supplied) (To be fixed with three screws)
- (D) Anti-vibration rubber pad (The pad needs to be large enough to cover the entire width of each unit leg.)
- (E) Detachable leg

WARNING
 Properly install the unit on a surface that can withstand the weight of the unit. Unit installed on an unstable surface may fall and cause injury.

WARNING
 Take appropriate safety measures against strong winds and earthquakes to prevent the unit from falling.

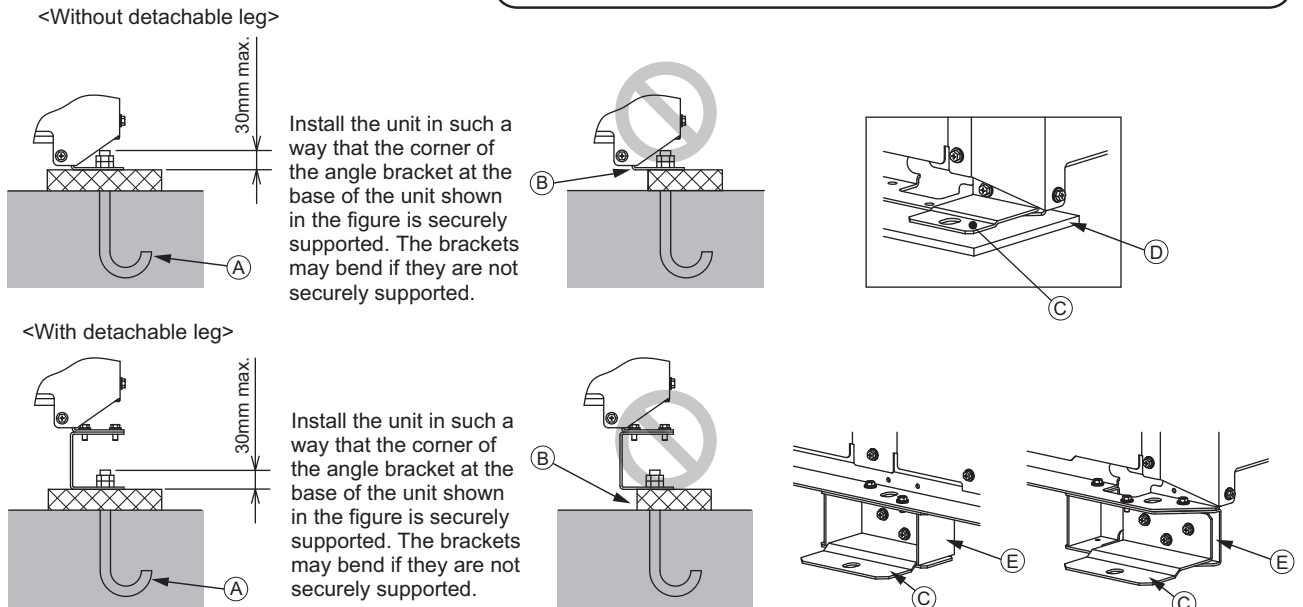

Take into consideration the durability of the base, water drainage route (Drain water is discharged from outdoor units during operation.), piping route, and wiring route when performing foundation work.

13-3-3. Anchor bolt positions

<P200-450>

• Individual installation

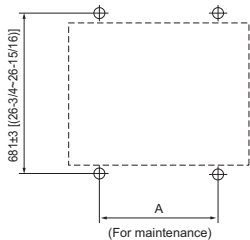

• Collective installation

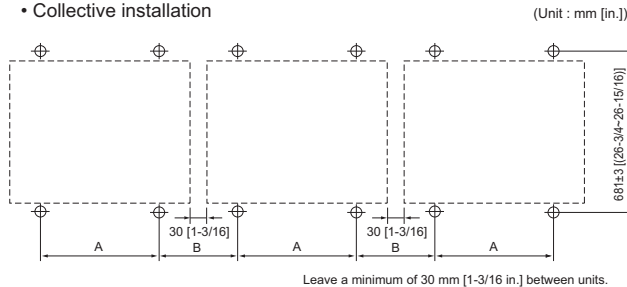

| | |
|------|-----------------------------|
| PUHY | P200, 250, 300 |
| A | 760±2 [29-15/16(29-7/8~30)] |
| B | 190 [7-1/2] |

| | |
|------|------------------------------------|
| PUHY | P350, 400, 450 |
| A | 1060±2 [41-3/4(41-11/16~41-13/16)] |
| B | 210 [8-5/16] |

<P500>

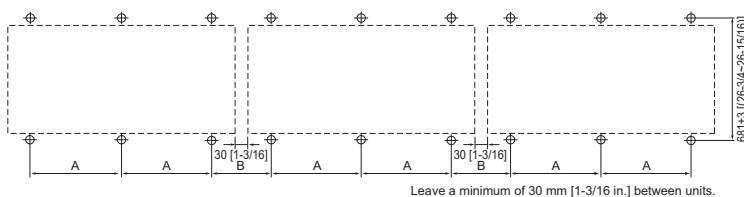
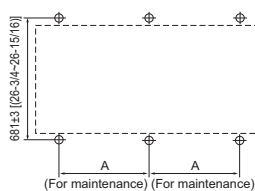

| | |
|------|---------------------------------|
| PUHY | P500 |
| A | 795±2 [31-5/16(31-1/4~31-7/16)] |
| B | 190 [7-1/2] |

PUHY-P-Y(S)NW-A1

13-3-4. Installation

When the pipes and/or cables are routed at the bottom of the unit, make sure that the through hole at the base of the unit does not get blocked with the installation base.
 When the pipes are routed at the bottom of the unit, the base should be at least 100 mm [3-15/16 in.] in height.

(Unit: mm[in.])

P200, 250, 300

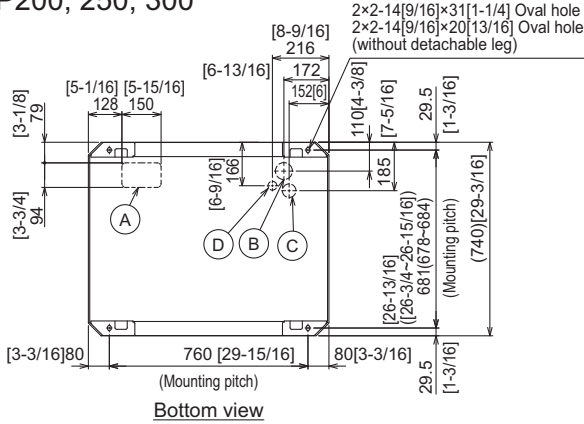

P350, 400, 450

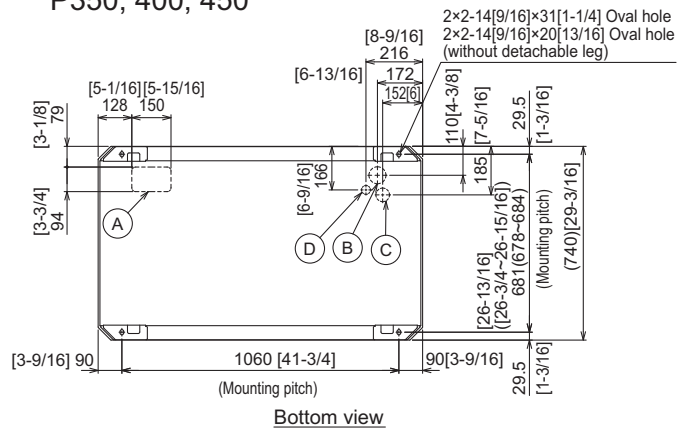

P500

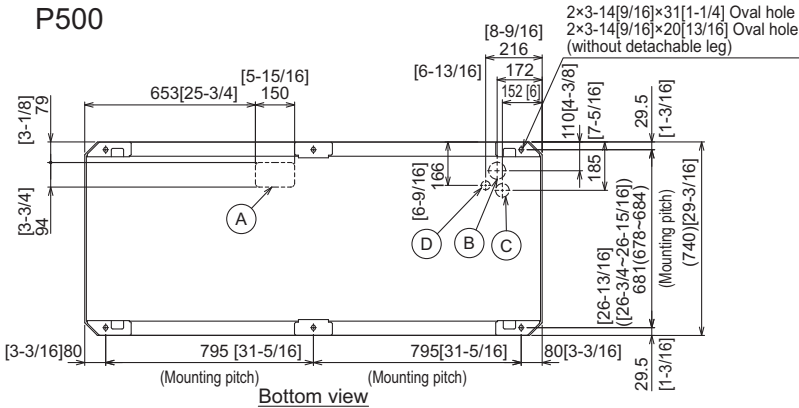

| NO. | Usage | Specifications |
|-----|-------------------------|--------------------------------------------------------------------|
| (A) | For pipes | Bottom through hole 150 x 94 Knockout hole [5-15/16] [3-3/4] |
| (B) | For wires | Bottom through hole ø65 Knockout hole [2-9/16] |
| (C) | | Bottom through hole ø52 Knockout hole [2-1/16] |
| (D) | For transmission cables | Bottom through hole ø34 Knockout hole [1-3/8] |

Installation base parallel to the unit's front panel

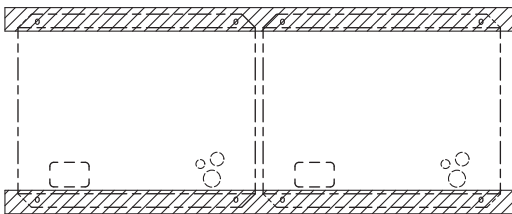

Installation base perpendicular to the unit's front panel

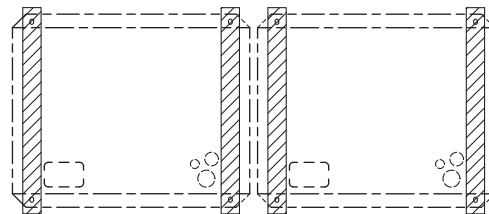

13-3-5. Refrigerant pipe routing

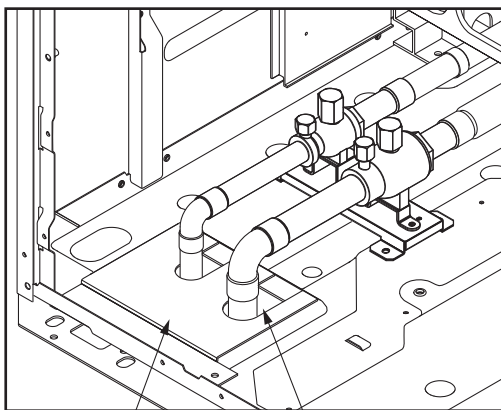

Example of closure materials (field supply) Fill the gap at the site

The gaps around the edges of through holes for pipes and wires on the unit allow water or mice to enter the unit and damage its parts. Close these gaps with filler plates.

This unit allows two types of pipe routing:

- Bottom piping
- Front piping

CAUTION

To prevent small animals, water and snow from entering the unit and damage its parts, close the gap around the edges of through holes for pipes and wires with filler plates.

13-3-6. Twinning on the outdoor unit side

- The tilt angle of the twinning pipe
 - The tilt angle of the twinning pipe must be within $\pm 15^\circ$ with the horizontal plane.
 - Tilting the twinning pipe more than specified will cause damage to the unit.
- The length of the straight part of the pipe before the branching
 - For the twinning kit, always use the accessory piping parts.
 - The length of the straight part of pipe connected in front of the twinning pipe must be 500 mm [19-11/16 in.] or longer.
 - (Connect the field piping so that the length of the straight part of pipe connected in front of the twinning pipe can be 500 mm [19-11/16 in.] or longer.)
 - If the length is less than 500 mm [19-11/16 in.], it will cause damage to the unit.

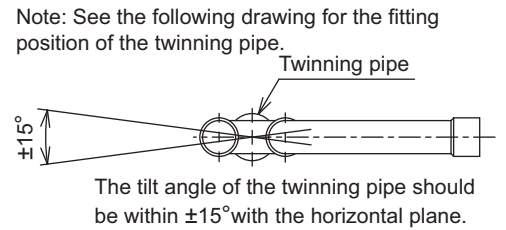

• Precautions for outdoor unit combinations

<A> Install the piping so that oil will not accumulate in the stopped outdoor unit.

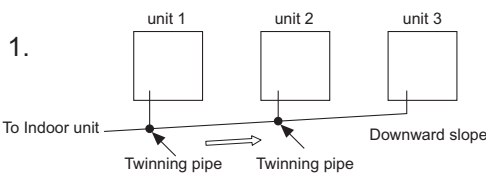

The NG example shows that oil accumulates because the units are installed on a reverse gradient while unit 1 is in operation, and unit 3 is stopped.

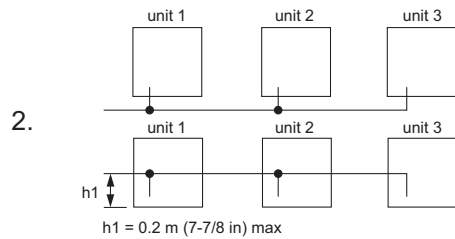
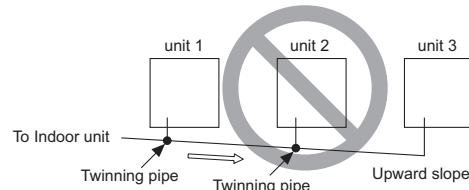

The NG example shows that oil accumulates into units 1 and 2 while unit 3 is in operation, and units 1 and 2 are stopped. Vertical pipe height (h) should be 0.2 m (7-7/8 in) or below.

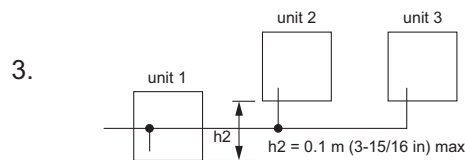
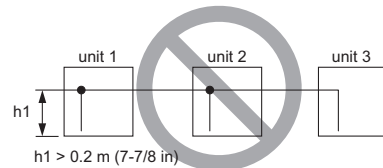

The NG example shows that oil accumulates into unit 1 while unit 3 is in operation, and unit 1 is stopped. Vertical pipe height (h) should be 0.1 m [3-15/16 in.] or below.

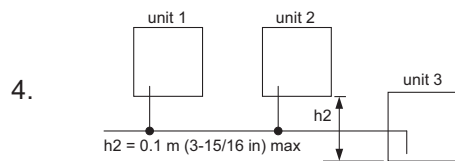
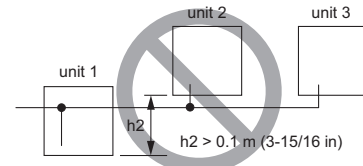

The NG example shows that oil accumulates into unit 3 while unit 1 is in operation, and unit 3 is stopped. Vertical pipe height (h) should be 0.1 m [3-15/16 in.] or below.

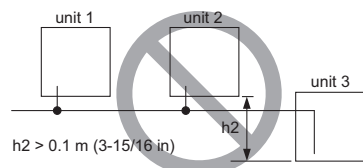

 When the piping on the outdoor unit side (from the twinning pipe) exceeds 2 m [6 ft.], ensure a trap (gas pipe only) within 2 m [6 ft.].

Make sure the height of the trap is 200 mm [7-7/8 in] or more.

If there is no trap, oil can accumulate inside the pipe, causing a shortage of oil and may damage the compressor.

<2 m [6 ft.] or less>

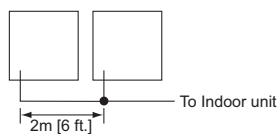

<More than 2 m [6 ft.]>

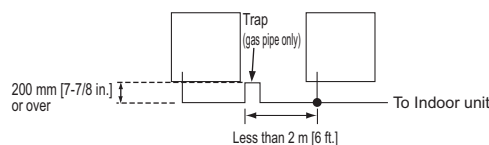

Caution:

- Do not install traps other than the ones between outdoor units described on a separate sheet to prevent oil backflow and compressor start-up failure.
 - Do not install solenoid valves to prevent oil backflow and compressor start-up failure.
 - Do not install a sight glass because it may show improper refrigerant flow.
- If a sight glass is installed, inexperienced technicians that use the glass may overcharge the refrigerant.

<PUHY-P550YSNW-A1>

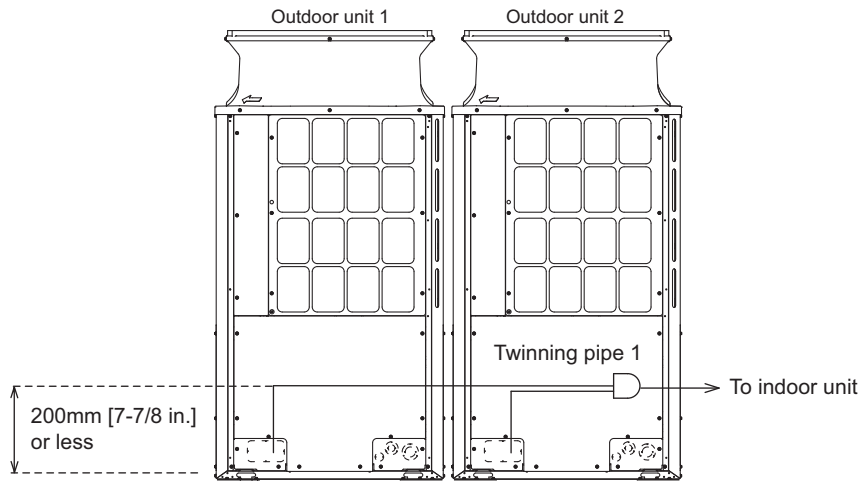

<PUHY-P950, 1000, 1050YSNW-A1>

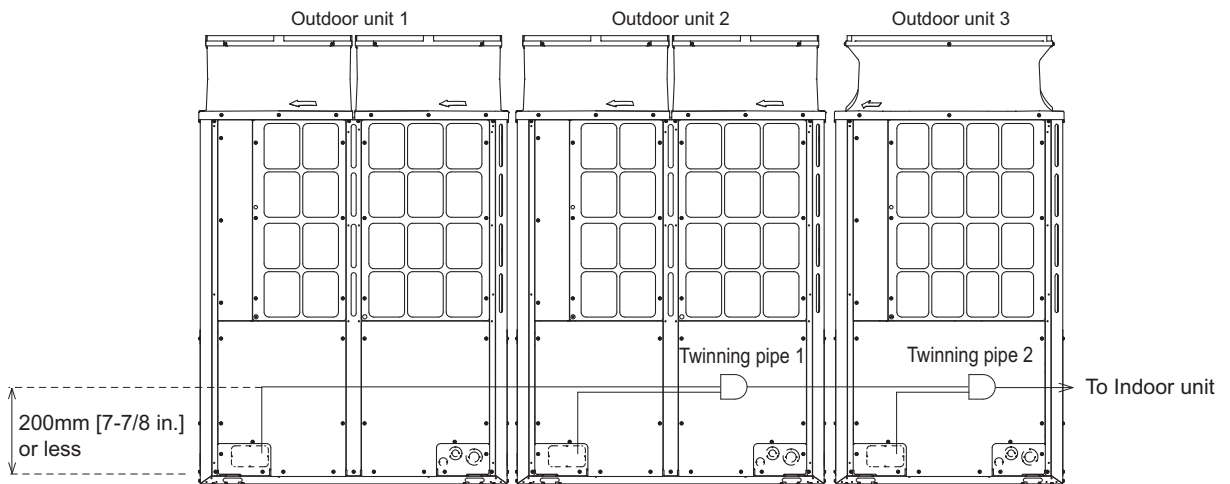

PUHY-P-Y(S)NW-A1

13-3-7. Twinning on the outdoor unit side

See the following drawing for connecting the pipes between the outdoor units.

<In case of 2units combination>

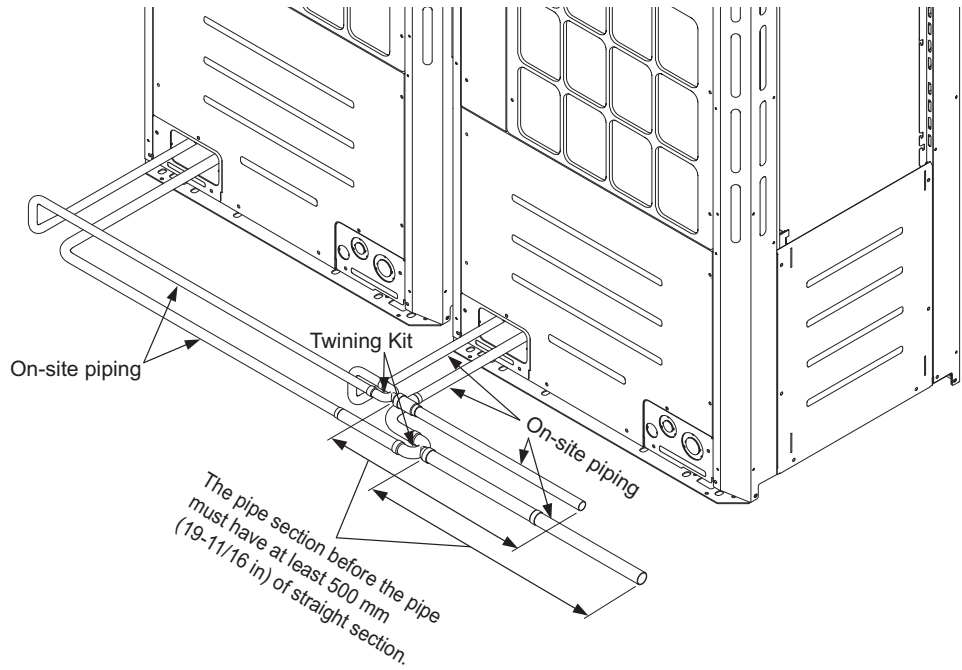

<In case of 3units combination>

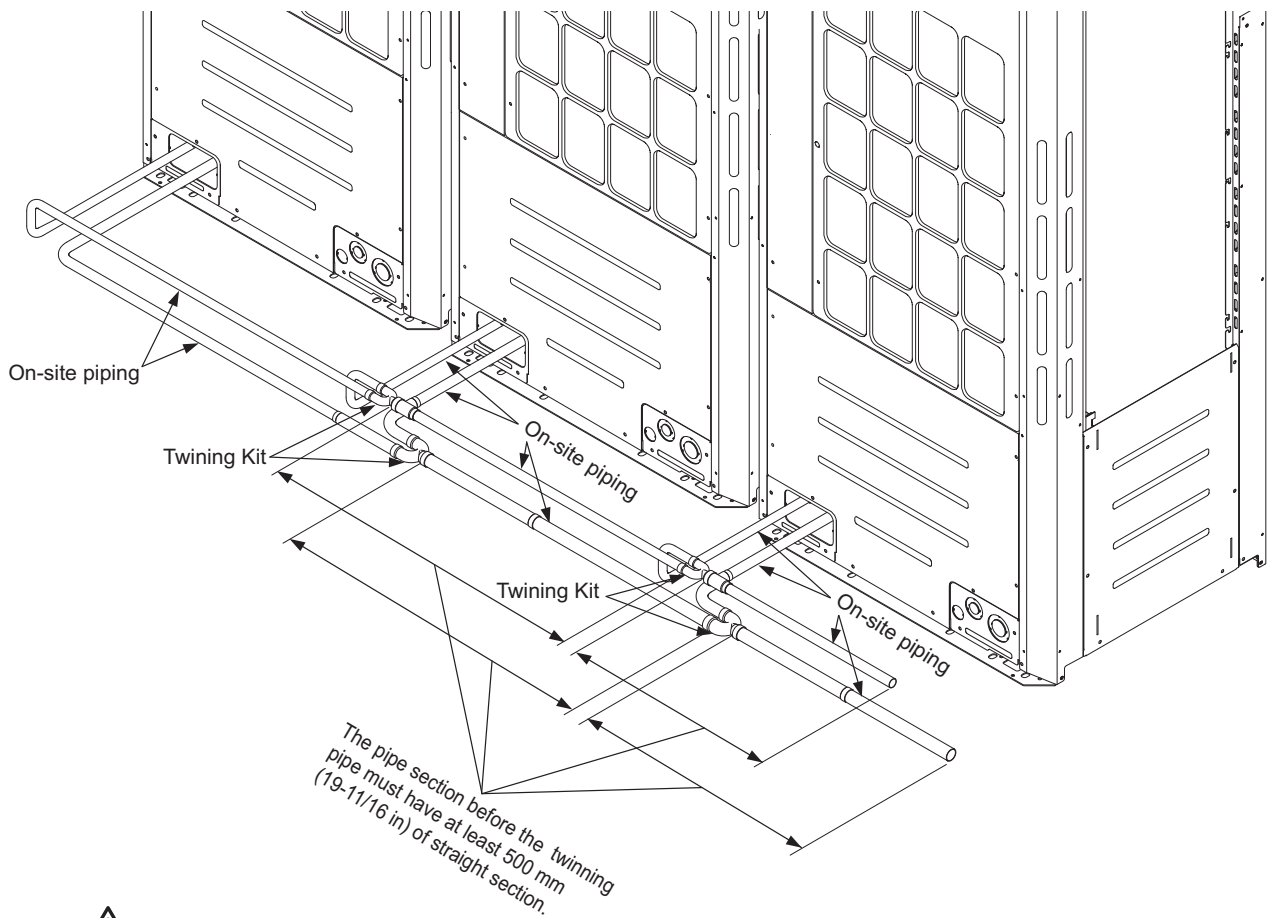

CAUTION

The length of the straight pipe must be 500mm[19-11/16 in.] or longer. If not, it may cause improper operation.

13-4. Countermeasure to wind

Referring to the figure shown below, take appropriate measures which will suit the actual situation of the place for installation. A unit installed alone is vulnerable to strong winds. Select the installation site carefully to minimize the effect of winds. To install a unit in a place where the wind always blows from the same direction, install the unit so that the outlet faces away from the direction of the wind.

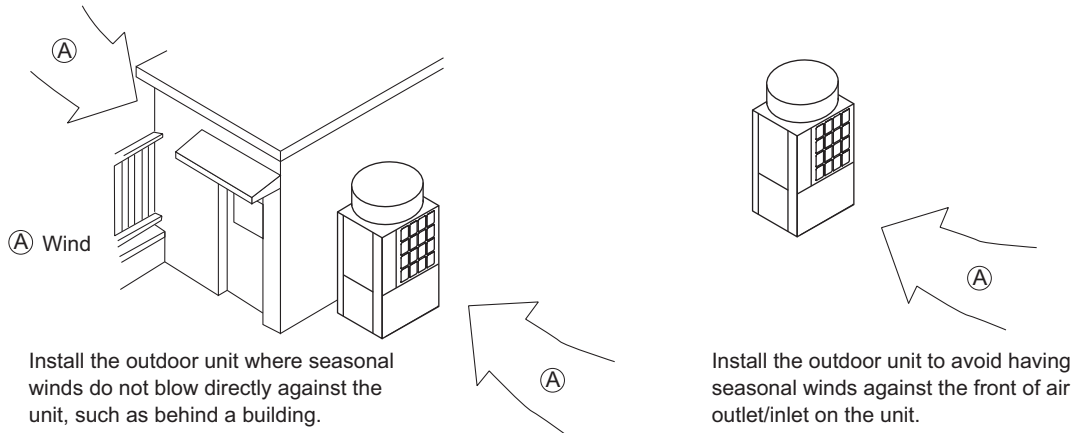

13-5. Precautions for installing a panel heater

If there is a risk that the drain water will freeze inside the outdoor unit, the installation of a panel heater is recommended. When installing a panel heater, provide sufficient space for maintenance accordingly. For details, refer to the installation manual for the panel heater.

13-6. Caution on selecting outdoor units

Consult your dealer when the following issues on Y-Series are the key concern.

- Warm air may flow out from the indoor unit during heating Thermo-OFF.
- Refrigerant flow sound may occur in the rooms with low background noise such as hotel rooms, hospital rooms, bedrooms, or conference rooms.

To avoid the above issues on Y-Series, changing board settings on the indoor and outdoor units is required. Ask AC&R Works for details.

Installation information

| | |
|--------------------------------------------------------------|---|
| 1. Installation information | 2 |
| 1-1. General precautions | 2 |
| 1-2. Precautions for Indoor unit and BC controller | 3 |
| 1-3. Precautions for Fresh air intake type indoor unit | 4 |
| 1-4. Precautions for Outdoor unit/Heat source unit..... | 5 |
| 1-5. Precautions for Control-related items | 6 |

* Refer to the enclosed Installation Manual for details on installation. Arrange to have an expert install the system correctly.

1-1. General precautions

1-1-1. Usage

- ♦The air-conditioning system described in this Data Book is designed for human comfort.
- ♦This product is not designed for preservation of food, animals, plants, precision equipment, or art objects. To prevent quality loss, do not use the product for purposes other than what it is designed for.
- ♦To reduce the risk of water leakage and electric shock, do not use the product for air-conditioning vehicles or vessels.

1-1-2. Installation environment

- ♦Do not install any unit other than the dedicated unit in a place where the voltage changes a lot, large amounts of mineral oil (e.g., cutting oil) are present, cooking oil may splash, or a large quantity of steam can be generated such as a kitchen.
- ♦Do not install the unit in acidic or alkaline environment.
- ♦Installation should not be performed in the locations exposed to chlorine or other corrosive gases. Avoid near a sewer.
- ♦To reduce the risk of fire, do not install the unit in a place where flammable gas may be leaked or inflammable material is present.
- ♦This air conditioning unit has a built-in microcomputer. Take the noise effects into consideration when deciding the installation position. Especially in a place where antenna or electronic device are installed, it is recommended that the air conditioning unit be installed away from them.
- ♦Install the unit on a solid foundation according to the local safety measures against typhoons, wind gusts, and earthquakes to prevent the unit from being damaged, toppling over, and falling.

1-1-3. Backup system

- ♦In a place where air conditioner's malfunctions may exert crucial influence, it is recommended to have two or more systems of single outdoor/heat source units with multiple indoor units.

1-1-4. Unit characteristics

- ♦Heat pump efficiency of outdoor unit depends on outdoor temperature. In the heating mode, performance drops as the outside air temperature drops. In cold climates, performance can be poor. Warm air would continue to be trapped near the ceiling and the floor level would continue to stay cold. In this case, heat pumps require a supplemental heating system or air circulator. Before purchasing them, consult your local distributor for selecting the unit and system.
- ♦When the outdoor temperature is low and the humidity is high, the heat exchanger on the outdoor unit side tends to collect frost, which reduces its heating performance. To remove the frost, Auto-defrost function will be activated and the heating mode will temporarily stop for 3-10 minutes. Heating mode will automatically resume upon completion of defrost process.
- ♦Air conditioner with a heat pump requires time to warm up the whole room after the heating operation begins, because the system circulates warm air in order to warm up the whole room.
- ♦The sound levels were obtained in an anechoic room. The sound levels during actual operation are usually higher than the simulated values due to ambient noise and echoes. Refer to the section on "SOUND LEVELS" for the measurement location.
- ♦Depending on the operation conditions, the unit generates noise caused by valve actuation, refrigerant flow, and pressure changes even when operating normally. Please consider to avoid location where quietness is required. For BC/HBC controller, it is recommended to unit to be installed in places such as ceilings of corridor, restrooms and plant rooms.
- ♦The total capacity of the connected indoor units can be greater than the capacity of the outdoor/heat source unit. However, when the connected indoor units operate simultaneously, each unit's capacity may become smaller than the rated capacity.
- ♦When the unit is started up for the first time within 12 hours after power on or after power failure, it performs initial startup operation (capacity control operation) to prevent damage to the compressor. The initial startup operation requires 90 minutes maximum to complete, depending on the operation load.

1-1-5. Relevant equipment

- ♦Use an earth leakage breaker (ELB) with medium sensitivity, and an activation speed of 0.1 second or less.
- ♦Consult your local distributor or a qualified technician when installing an earth leakage breaker.
- ♦If the unit is inverter type, select an earth leakage breaker for handling high harmonic waves and surges.
- ♦Leakage current is generated not only through the air conditioning unit but also through the power wires. Therefore, the leakage current of the main power supply is greater than the total leakage current of each unit. Take into consideration the capacity of the earth leakage breaker or leakage alarm when installing one at the main power supply. To measure the leakage current simply on site, use a measurement tool equipped with a filter, and clamp all the four power wires together. The leakage current measured on the ground wire may not accurate because the leakage current from other systems may be included to the measurement value.
- ♦Do not install a phase advancing capacitor on the unit connected to the same power system with an inverter type unit and its equipment.
- ♦If a large current flows due to the product malfunctions or faulty wiring, both the earth leakage breaker on the product side and the upstream overcurrent breaker may trip almost at the same time. Separate the power system or coordinate all the breakers depending on the system's priority level.

1-1-6. Unit installation

- ♦Your local distributor or a qualified technician must read the Installation Manual that is provided with each unit carefully before performing installation work.
- ♦Consult your local distributor or a qualified technician when installing the unit. Improper installation by an unqualified person may result in water leakage, electric shock, or fire.
- ♦Ensure there is enough space around each unit.

1-1-7. Optional accessories

- ♦Only use accessories recommended by Mitsubishi Electric. Consult your local distributor or a qualified technician when installing them. Improper installation by an unqualified person may result in water leakage, electric leakage, system breakdown, or fire.
- ♦Some optional accessories may not be compatible with the air conditioning unit to be used or may not be suitable for the installation conditions. Check the compatibility when considering any accessories.
- ♦Note that some optional accessories may affect the air conditioner's external form, appearance, weight, operating sound, and other characteristics.

1-1-8. Operation/Maintenance

- ♦Read the Instruction Book that is provided with each unit carefully prior to use.
- ♦Maintenance or cleaning of each unit may be risky and require expertise. Read the Instruction Book to ensure safety. Consult your local distributor or a qualified technician when special expertise is required such as when the indoor unit needs to be cleaned.

1-2. Precautions for Indoor unit and BC controller

1-2-1. Operating environment

- ♦The refrigerant (R410A) used for air conditioner is non-toxic and nonflammable. However, if the refrigerant leaks, the oxygen level may drop to harmful levels. If the air conditioner is installed in a small room, measures must be taken to prevent the refrigerant concentration from exceeding the safety limit even if the refrigerant should leak.
- ♦If the units operate in the cooling mode at the humidity above 80%, condensation may collect and drip from the indoor units.
- ♦Regular check and clean of the drain drainage path, such as the drain pan or the drain pump is recommended to prevent from clogging. The neglect of clogged drain pump may trigger the water-leakage protection function which stops the entire system operation.

1-2-2. Unit characteristics

- ♦The return air temperature display on the remote controller may differ from the ones on the other thermometers.
- ♦The clock on the remote controller may be displayed with a time lag of approximately one minute every month.
- ♦The temperature using a built-in temperature sensor on the remote controller may differ from the actual room temperature due to the effect of the wall temperature.
- ♦Use a built-in thermostat on the remote controller or a separately-sold thermostat when indoor units installed on or in the ceiling operate the automatic cooling/heating switchover.
- ♦The room temperature may rise drastically due to Thermo OFF in the places where the air conditioning load is large such as computer rooms.
- ♦Be sure to use a regular filter. If an irregular filter is installed, the unit may not operate properly, and the operation noise may increase.
- ♦The room temperature may rise over the preset temperature in the environment where the heating air conditioning load is small.

1-2-3. Unit installation

- ♦The insulation for low pressure pipe between the BC controller and outdoor/heat source unit shall be at least 20 mm thick. If the unit is installed on the top floor or in a high-temperature, high-humidity environment, thicker insulation may be necessary.
- ♦Do not have any branching points on the downstream of the refrigerant pipe header.
- ♦When a field-supplied external thermistor is installed or when a device for the demand control is used, abnormal stop of the unit or damage of the electromagnetic contactor may occur. Consult your local distributor for details.
- ♦When indoor units operate a fresh air intake, install a filter in the duct (field-supplied) to remove the dust from the air.
- ♦The 4-way or 2-way Airflow Ceiling Cassette Type units that have an outside air inlet can be connected to the duct, but need a booster fan to be installed at site. Refer to the chapter "Indoor Unit" for the available range for fresh air intake volume.
- ♦Operating fresh air intake on the indoor unit may increase the sound pressure level.

1-3. Precautions for Fresh air intake type indoor unit

1-3-1. Usage

- Fresh air intake type indoor unit is designed to supply pretreated outside air into the room. Do not use to handle internal thermal load.

1-3-2. Unit characteristics

For PEFY-P-VMH-E-F and PEFY-P-VMHS-E-F

- This unit cannot perform the drying operation. The unit will continue the fan operation and blow fresh air (air that is not air-conditioned) when the Heating Thermo OFF or Cooling Thermo OFF mode is selected.
- The fan may stop tentatively when the unit is connected to the simultaneous cooling/heating operation type outdoor/heat source unit (R2, WR2-Series) or during the defrost cycle.
- If only this unit is used as an indoor unit, condensation may form at the supply air grill while the unit is operated in the cooling mode. This unit cannot operate dehumidifying.
- The maximum connectable indoor units to 1 outdoor unit are 110% (100% in case of heating below -5°C).
- When fresh air intake type indoor units connect to an outdoor unit together with other types of indoor unit, the total capacity of fresh air intake type indoor units needs to be 30% or less of the connected outdoor unit capacity.
- The AUTO mode on the local remote controller is available only when fresh air intake type indoor unit is connected to the R2 or WR2-Series of outdoor unit.
- The system changeover function is available only when all the connected indoor units are fresh air intake type indoor units.
- Un-conditioned outdoor air such as humid air or cold air blows to the indoor during thermo off operation, which may occur dew condensation on the grills and ducts. Please insulate the grills, ducts, and rooms to prevent dew condensation properly.
- Air filter must be installed in the air intake side. The filter should be attached where easy maintenance is possible in case of usage of field supply filters.

For PEFY-P-VMH-E-F

- Outside air temperature ranges for the operation must be as follows:

Cooling: 21°C D.B./15.5°C W.B.—43°C D.B./35°C W.B.

Heating: -10°C D.B.—+20°C D.B.

The unit is forced to operate Thermo OFF (fan operation) when the outside air temperature is as follows.

Cooling: 21°C D.B. or below; Heating: 20°C D.B. or above

- This unit switches the Thermo ON or OFF depending on the room temperature. The outside air is directly supplied into the room during Thermo OFF. Take caution of the cold supply air due to low outside air temperature and of condensation in the room due to high humidity of the outside air.
- Either a remote controller (sold separately) or a remote sensor (sold separately) must be installed to monitor the room temperature.
- Use the unit in the way that the airflow rate will not exceed the 110% of the rated airflow.
- Depending on the air conditioning load, outside temperature, and due to the activation of protection functions, the discharge temperature may swing. Note that untreated outside air may be delivered directly into the room upon the activation of protection functions.

For PEFY-P-VMHS-E-F

- Outside air temperature ranges for the operation must be as follows:

Cooling: 17°C D.B./15.5°C W.B.—43°C D.B./35°C W.B.

Heating: -10°C D.B.—+20°C D.B.

The unit is forced to operate Thermo OFF (fan operation) when the outside air temperature is as follows.

Cooling: 17°C D.B. or below; Heating: 20°C D.B. or above

- The outside air is directly supplied into the room during Thermo OFF. Take caution of the cold supply air due to low outside air temperature and of condensation in the room due to high humidity of the outside air.
- If the airflow rate is over the usable range, dew drop can be caused from the air outlet and the air flow rate is changed automatically because of the output down by the fan motor control. If the air flow rate is less than the usable range, condensation from the unit surface can be caused.
- The combination of fresh air intake type indoor units with other types of indoor units to handle internal thermal load which may cause the conflict of operation mode. It is not recommended when fresh air intake type indoor unit is connected to the Y or WY-Series.
- Depending on the air conditioning load, outside temperature, and due to the activation of protection functions, the desired preset temperature may not always be achieved and the discharge temperature may swing. Note that untreated outside air may be delivered directly into the room upon the activation of protection functions.
- Fresh air intake type indoor units cannot be connected to PUMY and cannot be connected to an outdoor unit together with PWFY-Series.

1-4. Precautions for Outdoor unit/Heat source unit

1-4-1. Installation environment

- ♦Outdoor unit with salt-resistant specification is recommended to use in a place where it is subject to salt air.
- ♦Even when the unit with salt-resistant specification is used, it is not completely protected against corrosion. Be sure to follow the directions or precautions described in Instructions Book and Installation Manual for installation and maintenance. The salt-resistant specification is referred to the guidelines published by JRAIA (JRA9002).
- ♦Install the unit in a place where the flow of discharge air is not obstructed. If not, the short-cycling of discharge air may occur.
- ♦Provide proper drainage around the unit base, because the condensation may collect and drip from the outdoor units. Provide water-proof protection to the floor when installing the units on the rooftop.
- ♦In a region where snowfall is expected, install the unit so that the outlet faces away from the direction of the wind, and install a snow guard to protect the unit from snow. Install the unit on a base approximately 50 cm higher than the expected snowfall. Close the openings for pipes and wiring, because the ingress of water and small animals may cause equipment damage. If SUS snow guard is used, refer to the Installation Manual that comes with the snow guard and take caution for the installation to avoid the risk of corrosion.
- ♦When the unit is expected to operate continuously for a long period of time at outside air temperatures of below 0°C, take appropriate measures, such as the use of a unit base heater, to prevent icing on the unit base. (Not applicable to the PUMY-Series)
- ♦Install the snow guard so that the outlet/inlet faces away from the direction of the wind.
- ♦When the snow accumulates approximately 50 cm or more on the snow guard, remove the snow from the guard. Install a roof that is strong enough to withstand snow loads in a place where snow accumulates.
- ♦Provide proper protection around the outdoor units in places such as schools to avoid the risk of injury.
- ♦A cooling tower and heat source water circuit should be a closed circuit that water is not exposed to the atmosphere. When a tank is installed to ensure that the circuit has enough water, minimize the contact with outside air so that the oxygen from being dissolved in the water should be 1 mg/L or less.
- ♦Install a strainer (50 mesh or more recommended) on the water pipe inlet on the heat source unit.
- ♦Interlock the heat source unit and water circuit pump.
- ♦Note the followings to prevent the freeze bursting of pipe when the heat source unit is installed in a place where the ambient temperature can be 0°C or below.
 - ♦Keep the water circulating to prevent it from freezing when the ambient temperature is 0°C or below.
 - ♦Before a long period of non use, be sure to purge the water out of the unit.
- ♦Salt-resistant unit is resistant to salt corrosion, but not salt-proof.

Please note the following when installing and maintaining outdoor units in marine atmosphere.

 1. Install the salt-resistant unit out of direct exposure to sea breeze, and minimize the exposure to salt water mist.
 2. Avoid installing a sun shade over the outdoor unit, so that rain will wash away salt deposits off the unit.
 3. Install the unit horizontally to ensure proper water drainage from the base of the unit. Accumulation of water in the base of the outdoor unit will significantly accelerate corrosion.
 4. Periodically wash salt deposits off the unit, especially when the unit is installed in a coastal area.
 5. Repair all noticeable scratches after installation and during maintenance.
 6. Periodically check the unit, and apply anti-rust agent and replace corroded parts as necessary.

1-4-2. Circulating water

- ♦Follow the guidelines published by JRAIA (JRA-GL02-1994) to check the water quality of the water in the heat source unit regularly.
- ♦A cooling tower and heat source water circuit should be a closed circuit that water is not exposed to the atmosphere. When a tank is installed to ensure that the circuit has enough water, minimize the contact with outside air so that the oxygen from being dissolved in the water should be 1 mg/L or less.

1-4-3. Unit characteristics

- ♦When the Thermo ON and OFF is frequently repeated on the indoor unit, the operation status of outdoor/heat source units may become unstable.

1-4-4. Relevant equipment

- ♦Provide grounding in accordance with the local regulations.

1-5. Precautions for Control-related items

1-5-1. Product specification

- ♦To introduce the MELANS system, a consultation with us is required in advance. Especially to introduce the electricity charge apportioning function or energy-save function, further detailed consultation is required. Consult your local distributor for details.
- ♦Billing calculation for AE-200E/AE-50E/EW-50E/AG-150A/EB-50GU-J/TG-2000A, or the billing calculation unit is unique and based on our original method. (Backup operation is included.) It is not based on the metering method, and do not use it for official business purposes. It is not the method that the amount of electric power consumption (input) by air conditioner is calculated. Note that the electric power consumption by air conditioner is apportioned by using the ratio corresponding to the operation status (output) for each air conditioner (indoor unit) in this method.
- ♦In the apportioned billing function for AE-200E/AE-50E/EW-50E/AG-150A and EB-50GU-J, use separate watt-hour meters for A-control units, K-control units, and packaged air conditioner for City Multi air conditioners. It is recommended to use an individual watt-hour meter for the large-capacity indoor unit (with two or more addresses).
- ♦When using the peak cut function on the AE-200E/AE-50E/EW-50E/AG-150A or EB-50GU-J, note that the control is performed once every minute and it takes time to obtain the effect of the control. Take appropriate measures such as lowering the criterion value. Power consumption may exceed the limits if AE-200E/AE-50E/EW-50E/AG-150A or EB-50GU-J malfunctions or stops. Provide a back-up remedy as necessary.
- ♦The controllers cannot operate while the indoor unit is OFF. (No error)
Turn ON the power to the indoor unit when operating the controllers.
- ♦When using the interlocked control function on the AE-200E/AE-50E/EW-50E/AG-150A/EB-50GU-J/PAC-YG66DCA or PAC-YG63MCA, do not use it for the control for the fire prevention or security. (This function should never be used in the way that would put people's lives at risk.) Provide any methods or circuit that allow ON/OFF operation using an external switch in case of failure.

1-5-2. Installation environment

- ♦The surge protection for the transmission line may be required in areas where lightning strikes frequently occur.
- ♦A receiver for a wireless remote controller may not work properly due to the effect of general lighting. Leave a space of at least 1 m between the general lighting and receiver.
- ♦When the Auto-elevating panel is used and the operation is made by using a wired remote controller, install the wired remote controller to the place where all air conditioners controlled (at least the bottom part of them) can be seen from the wired remote controller. If not, the descending panel may cause damage or injury, and be sure to use a wireless remote controller designed for use with elevating panel (sold separately).
- ♦Install the wired remote controller (switch box) to the place where the following conditions are met.
 - ♦Where installation surface is flat
 - ♦Where the remote controller can detect an accurate room temperature
The temperature sensors that detect a room temperature are installed both on the remote controller and indoor unit. When a room temperature is detected using the sensor on the remote controller, the main remote controller is used to detect a room temperature. In this case, follow the instructions below.
 - ♦ Install the controller in a place where it is not subject to the heat source.
(If the remote controller faces direct sunlight or supply air flow direction, the remote controller cannot detect an accurate room temperature.)
 - ♦ Install the controller in a place where an average room temperature can be detected.
 - ♦ Install the controller in a place where no other wires are present around the temperature sensor.
(If other wires are present, the remote controller cannot detect an accurate room temperature.)
- ♦To prevent unauthorized access, always use a security device such as a VPN router when connecting AE-200E/AE-50E/EW-50E/AG-150A/EB-50GU-J or TG-2000A to the Internet.

CAUTION FOR REFRIGERANT LEAKAGE

| | |
|-----------------------------------------------------------------------|-------|
| 1. Caution for refrigerant leakage | b-3-2 |
| 1-1. Refrigerant property | b-3-2 |
| 1-2. Confirm the Critical concentration and take countermeasure | b-3-2 |

1. Caution for refrigerant leakage

The installer and/or air conditioning system specialist shall secure safety against refrigerant leakage according to local regulations or standards. The following standard may be applicable if no local regulation or standard is available.

1-1. Refrigerant property

R410A refrigerant is harmless and incombustible. The R410A is heavier than the indoor air in density. Leakage of the refrigerant in a room has possibility to lead to a hypoxia situation. Therefore, the critical concentration specified below shall not be exceeded even if the leakage happens.

• Critical concentration

Critical concentration hereby is the refrigerant concentration in which no human body would be hurt if immediate measures can be taken when refrigerant leakage happens.

Critical concentration of R410A: 0.44kg/m³
(The weight of refrigeration gas per 1 m³ air conditioning space.);

* The Critical concentration is subject to ISO5149, EN378-1.

For the CITY MULTI system, the concentration of refrigerant leaked should not have a chance to exceed the critical concentration in any situation.

1-2. Confirm the Critical concentration and take countermeasure

The maximum refrigerant leakage concentration (Rmax) is defined as the result of the possible maximum refrigerant weight (Wmax) leaked into a room divided by its room capacity (V). It is referable to Fig.1-1. The refrigerant of Outdoor/Heat source unit here includes its original charge and additional charge at the site.

The additional charge is calculated according to the refrigerant charging calculation of each kind of Outdoor/Heat source unit, and shall not be over charged at the site. Procedure 1-2-1~3 tells how to confirm maximum refrigerant leakage concentration (Rmax) and how to take countermeasures against a possible leakage.

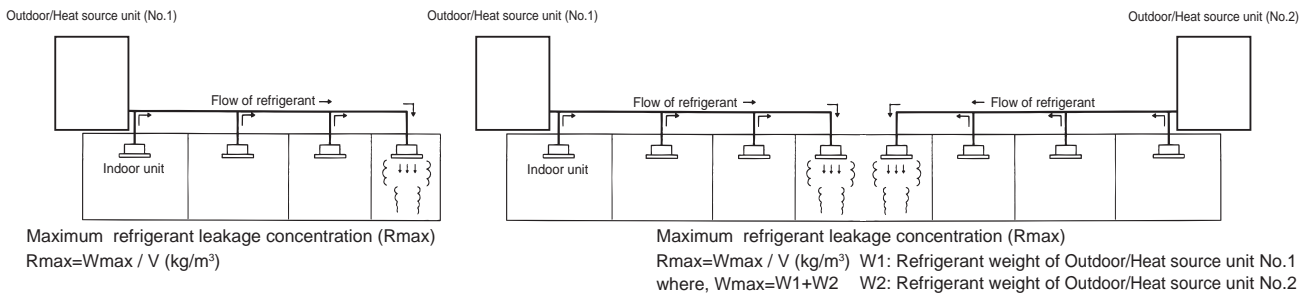

Fig. 1-1 The maximum refrigerant leakage concentration

1-2-1. Find the room capacity (V),

If a room having total opening area more than 0.15% of the floor area at a low position with another room/space, the two rooms/space are considered as one. The total space shall be added up.

1-2-2. Find the possible maximum leakage (Wmax) in the room. If a room has Indoor unit(s) from more than 1 Outdoor/Heat source unit, add up the refrigerant of the Outdoor/Heat source units.

1-2-3. Divide (Wmax) by (V) to get the maximum refrigerant leakage concentration (Rmax).

1-2-4. Find if there is any room in which the maximum refrigerant leakage concentration (Rmax) is over 0.44kg/m³.

If no, then the CITY MULTI is safe against refrigerant leakage.

If yes, following countermeasure is recommended to do at site.

Countermeasure 1: Let-out (making V bigger)

Design an opening of more than 0.15% of the floor area at a low position of the wall to let out the refrigerant whenever leaked. e.g. make the upper and lower seams of door big enough.

Countermeasure 2: Smaller total charge (making Wmax smaller)

e.g. Avoid connecting more than 1 Outdoor/Heat source unit to one room.

e.g. Using smaller model size but more Outdoor/Heat source units.

e.g. Shorten the refrigerant piping as much as possible.

Countermeasure 3: Fresh air in from the ceiling (Ventilation)

As the density of the refrigerant is bigger than that of the air. Fresh air supply from the ceiling is better than air exhausting from the ceiling.

Fresh air supply solution refers to Fig.1-2~4.

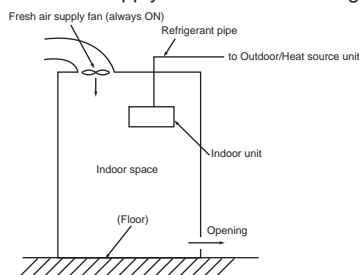

Fig.1-2. Fresh air supply always ON

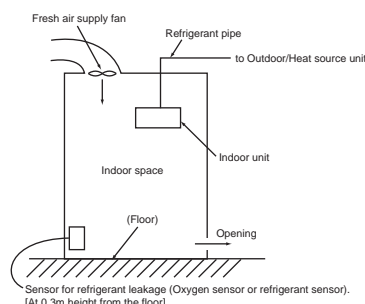

Fig.1-3. Fresh air supply upon sensor action

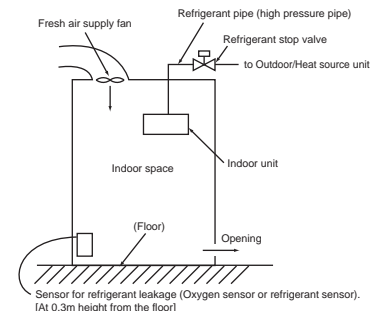

Fig.1-4. Fresh air supply and refrigerant shut-off upon sensor action

Note 1. Countermeasure 3 should be done in a proper way in which the fresh air supply shall be on whenever the leakage happens.

Note 2. In principle, MITSUBISHI ELECTRIC requires proper piping design, installation and air-tight testing after installation to avoid leakage happening.

In the area should earthquake happen, anti-vibration measures should be fully considered.

The piping should consider the extension due to the temperature variation.



for a greener tomorrow

Eco Changes is the Mitsubishi Electric Group's environmental statement, and expresses the Group's stance on environmental management. Through a wide range of businesses, we are helping contribute to the realization of a sustainable society.

⚠ Warning

- Do not use refrigerant other than the type indicated in the manuals provided with the unit and on the nameplate.
 - Doing so may cause the unit or pipes to burst, or result in explosion or fire during use, repair, or at the time of disposal of the unit.
 - It may also be in violation of applicable laws.
 - MITSUBISHI ELECTRIC CORPORATION cannot be held responsible for malfunctions or accidents resulting from the use of the wrong type of refrigerant.
- Our air conditioning equipment and heat pumps contain a fluorinated greenhouse gas, R410A.

MITSUBISHI ELECTRIC CORPORATION